



POSITIP 8000

Operating Instructions
Turning

Digital Readout

Notes on the structure of this document

This document consists of three main parts:

Part	Chapter
I	General Information
This part of the documentation provides general information for all persons who come into contact with the product.	<ul style="list-style-type: none"> ■ "Fundamentals", Page 7 ■ "Safety", Page 15 ■ "Basic Operation", Page 19
II	Information for OEM and Setup Users
This part of the documentation provides information on the installation, commissioning and setup of the product.	<ul style="list-style-type: none"> ■ "Transport and Storage", Page 60 ■ "Mounting", Page 65 ■ "Installation", Page 71 ■ "Commissioning", Page 81 ■ "Setup", Page 155 ■ "File Management", Page 173 ■ "Settings", Page 180 ■ "Servicing and Maintenance", Page 199 ■ "Removal and Disposal", Page 211 ■ "Specifications", Page 213
III	Information for the Operator
This part of the documentation provides information on the operation of the device. It serves for daily reference when working with the device.	<ul style="list-style-type: none"> ■ "Manual operation", Page 225 ■ "MDI mode", Page 234 ■ "Program run", Page 246 ■ "Programming", Page 255 ■ "Application example", Page 267 ■ "What to do if ...", Page 285
Appendix	<ul style="list-style-type: none"> ■ "Index", Page 291 ■ "List of figures", Page 294



General Information

Overview

This part of the documentation contains general information for the OEM, Setup and Operator users.

Contents of chapters in the "General information" part

The table below shows:

- The chapters included in this "General information" part
- The information contained in these chapters
- The target groups that these chapters are mainly intended for

Chapter	Contents	Target group		
		OEM	Setup	Operator
	This chapter contains information about...			
1 "Fundamentals"	<ul style="list-style-type: none"> ... this product ... these instructions 	✓	✓	✓
2 "Safety"	<ul style="list-style-type: none"> ... safety regulations and safety measures <ul style="list-style-type: none"> ■ for mounting the product ■ for installing the product ■ for operating the product 	✓	✓	✓
3 "Basic Operation"	<ul style="list-style-type: none"> ... the operating elements of the product user interface ... the user interface of the product ... basic functions of the product 	✓	✓	✓



Table of contents

1	Fundamentals.....	7
1.1	Overview.....	8
1.2	Information on the product.....	8
1.3	Overview of new and modified functions.....	9
1.4	Demo software for the product.....	9
1.5	Documentation on the product.....	10
1.5.1	Validity of the documentation.....	10
1.5.2	Notes on reading the documentation.....	11
1.5.3	Storage and distribution of the documentation.....	12
1.6	About these instructions.....	12
1.6.1	Document category.....	12
1.6.2	Target groups for the instructions.....	12
1.6.3	Target groups according to user types.....	13
1.6.4	Notes in this documentation.....	13
1.6.5	Symbols and fonts used for marking text.....	14
2	Safety.....	15
2.1	Overview.....	16
2.2	General safety precautions.....	16
2.3	Intended use.....	16
2.4	Improper use.....	16
2.5	Personnel qualification.....	16
2.6	Obligations of the operating company.....	17
2.7	General safety precautions.....	17
2.7.1	Symbols on the product.....	18
2.7.2	Electrical safety precautions.....	18
3	Basic Operation.....	19
3.1	Overview.....	20
3.2	Using the touchscreen and input devices.....	20
3.2.1	Touchscreen and input devices.....	20
3.2.2	Gestures and mouse actions.....	20
3.3	General operating elements and functions.....	22
3.4	POSITIP 8000 – switch-on and switch-off.....	24
3.4.1	Switching on the POSITIP 8000.....	24
3.4.2	Activating and deactivating the energy saving mode.....	24
3.4.3	Switching off the POSITIP 8000.....	25
3.5	User login and logout.....	25
3.5.1	User login.....	26
3.5.2	User logout.....	26
3.6	Setting the language.....	27
3.7	Performing the reference mark search after startup.....	27
3.8	User interface.....	28
3.8.1	User interface after switch-on.....	28
3.8.2	Main menu of the user interface.....	29
3.8.3	Manual operation menu.....	31
3.8.4	MDI menu.....	32
3.8.5	Program run menu.....	34
3.8.6	Programming menu.....	35

3.8.7	File management menu.....	37
3.8.8	User login menu.....	38
3.8.9	Settings menu.....	39
3.8.10	Switch-off menu.....	40
3.9	Position display.....	40
3.9.1	Operating elements of the position display.....	40
3.9.2	Position display functions.....	41
3.10	Status bar.....	45
3.10.1	Operating elements of the status bar.....	45
3.10.2	Adjusting settings in the quick access menu.....	46
3.10.3	Stopwatch.....	48
3.10.4	Calculator.....	48
3.10.5	Setting the feed-rate value.....	48
3.10.6	Entering and activating the jog increment.....	49
3.10.7	Additional functions in Manual operation mode.....	49
3.11	OEM bar.....	49
3.11.1	Operating elements of the OEM bar.....	50
3.11.2	Calling functions of the OEM bar.....	50
3.12	Messages and audio feedback.....	51
3.12.1	Messages.....	51
3.12.2	Wizard.....	53
3.12.3	Audio feedback.....	53

1

Fundamentals

1.1 Overview

This chapter contains information about the product and this manual.

1.2 Information on the product

Product designation	ID	Firmware version	Index
POSITIP 8000	1089176-xx, 1089177-xx	1252216.1.3.x	---

The ID label is provided on the rear panel of the product.

Example:

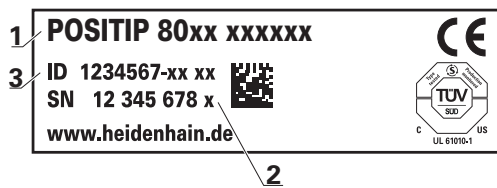

- 1 Product designation
- 2 Index
- 3 ID number

1.3 Overview of new and modified functions

This document provides a short overview of new and modified functions or settings becoming available with version 1252216.1.3.x.

Configurable time intervals for zeroing and value transfer

Two new parameters are introduced with this version, enabling the definition of time intervals for zeroing over the axis label and value transfer to the OEM bar.

Further information: "User interface", Page 186

Display area for simulation window

This version introduces a new parameter (**Minimum display range**) allowing the minimum display area of the simulation window to be defined. With this parameter you can make sure that you always have everything in view in the simulation.

Further information: "Simulation window", Page 185

Coupling of Z and Zo

With this version the behavior changes when coupling Z and Zo. If you decouple the axes again, the sum is now written to the Z axis and the Zo axis is set to zero.

Further information: "Coupling axes", Page 41

Rapid traverse superimposition

Prerequisite: NC1 software option

To prevent unintentional overwriting of the set or programmed feed rate by pressing the rapid traverse key, you can now deactivate the rapid traverse key via a parameter. Each OEM can configure this according to his needs.

Further information: "Program execution", Page 148

Value transfer of the spindle speed via Teach

It is now possible to directly adopt the current spindle speed with the Actual position button.

M functions: OEM-specific texts

OEMs can now show information texts for M functions. A text ID (language-dependent) or a fixed text can be configured.

Further information: "Configuring M functions", Page 149

1.4 Demo software for the product

POSITIP 8000 Demo is software you can install on a computer regardless of the device. POSITIP 8000 Demo helps you to become familiar with, try out or present the functions of the device.

You can download the current version of the software here:

<https://portal.heidenhain.de>



To download the installation file from the HEIDENHAIN Portal, you need access rights to the **Software** portal folder in the directory of the appropriate product.

If you do not have access rights to the Portal's **Software** folder, you can request the access rights from your HEIDENHAIN contact person.

1.5 Documentation on the product

1.5.1 Validity of the documentation

Before using the documentation and the product, you need to verify that the documentation matches the product.

- ▶ Compare the ID number and the index indicated in the documentation with the corresponding data given on the ID label of the product
- ▶ Compare the firmware version given in the documentation with the firmware version of the product

Further information: "Device information", Page 182

- > If the part numbers and indexes as well as the firmware versions match, the documentation is valid.



If the ID numbers and indexes do not match so that the documentation is not valid, you will find the current documentation at www.heidenhain.com.



1.5.2 Notes on reading the documentation

⚠ WARNING	
Fatal accidents, personal injury or property damage caused by non-compliance with the documentation!	
Failure to comply with the documentation may result in fatal accidents, personal injury or property damage.	
<ul style="list-style-type: none"> ▶ Read the documentation carefully from beginning to end ▶ Keep the documentation for future reference 	

The table below lists the components of the documentation in the order of priority for reading.

Documentation	Description
Addendum	An Addendum supplements or supersedes the corresponding contents of the Operating Instructions and, if applicable, of the Installation Instructions. If an Addendum is included in the shipment, it has the highest priority for reading. All other contents of the documentation retain their validity.
Installation Instructions	The Installation Instructions contain all of the information and safety precautions needed for the proper mounting and installation of the product. The Installation Instructions are contained as an excerpt from the Operating Instructions in every delivery. The Installation Instructions have the second highest level of priority for reading.
Operating Instructions	The Operating Instructions contain all the information and safety precautions needed for the proper operation of the product according to its intended use. The Operating Instructions are included on the supplied storage medium and can also be downloaded in the download area from www.heidenhain.com . The Operating Instructions must be read before the unit is put into service. The Operating Instructions have the third highest level of priority for reading.
User's Manual	The User's Manual provides all information required for installing the demo software on a computer and for using it as intended. The User's Manual is located in the installation folder of the demo software and can be downloaded from the download area at www.heidenhain.com .

Have you found any errors or would you like to suggest changes?

We are continuously striving to improve our documentation for you. Please help us by sending your suggestions to the following e-mail address:

userdoc@heidenhain.de

1.5.3 Storage and distribution of the documentation

The instructions must be kept in the immediate vicinity of the workplace and must be available to all personnel at all times. The operating company must inform the personnel where these instructions are kept. If the instructions have become illegible, the operating company must obtain a new copy from the manufacturer.

If the product is given or resold to any other party, the following documents must be passed on to the new owner:

- Addendum (if supplied)
- Installation Instructions
- Operating Instructions

1.6 About these instructions

These instructions provide all the information and safety precautions needed for the safe operation of the device.

1.6.1 Document category

Operating Instructions

These instructions are the **Operating Instructions** for the product.

The Operating Instructions

- Is oriented to the product life cycle
- Contains all information and safety precautions needed for the proper operation of the product according to its intended use

1.6.2 Target groups for the instructions

These instructions must be read and observed by every person who performs any of the following tasks:

- Mounting
- Installation
- Commissioning and configuration
- Operation
- Service, cleaning and maintenance
- Troubleshooting
- Removal and disposal



1.6.3 Target groups according to user types

The target groups of these instructions refer to the various user types of the product and their authorizations.

The product features the following user types:

OEM user

The **OEM** (Original Equipment Manufacturer) user has the highest level of permissions. This user is allowed to configure the product's hardware (e.g. connection of encoders and sensors). He can create **Setup** and **Operator**-type users, and configure the **Setup** and **Operator** users. The **OEM** user cannot be duplicated or deleted. This user cannot be logged in automatically.

Setup user

The **Setup** user configures the product for use at the place of operation. This user can create **Operator**-type users. The **Setup** user cannot be duplicated or deleted. This user cannot be logged in automatically.

Operator user

The **Operator** user is permitted to use the basic functions of the product. An **Operator**-type user cannot create additional users, but is allowed to edit various operator-specific settings, such as his name or the language. A user of the **Operator** group can be logged in automatically as soon as the product is switched on.

1.6.4 Notes in this documentation



Safety precautions

Precautionary statements warn of hazards in handling the product and provide information on their prevention. Precautionary statements are classified by hazard severity and divided into the following groups:

⚠ DANGER
Danger indicates hazards for persons. If you do not follow the avoidance instructions, the hazard will result in death or severe injury.
⚠ WARNING
Warning indicates hazards for persons. If you do not follow the avoidance instructions, the hazard could result in death or serious injury.
⚠ CAUTION
Caution indicates hazards for persons. If you do not follow the avoidance instructions, the hazard could result in minor or moderate injury.
NOTICE
Notice indicates danger to material or data. If you do not follow the avoidance instructions, the hazard could result in property damage.

Informational notes

Informational notes ensure reliable and efficient operation of the product. Informational notes are divided into the following groups:

	The information symbol indicates a tip . A tip provides important additional or supplementary information.
	The gear symbol indicates a function that depends on the machine . The function described depends on the machine if, for example: <ul style="list-style-type: none"> ■ A certain software or hardware option is required on your machine ■ The behavior of the functions depends on the configurable machine settings
	The book symbol indicates a cross reference . A cross reference leads to external documentation for example the documentation of your machine manufacturer or other supplier.

1.6.5 Symbols and fonts used for marking text

In these instructions the following symbols and fonts are used for marking text:

Depiction	Meaning
▶ ...	Identifies an action and the result of this action
> ...	Example: <ul style="list-style-type: none"> ▶ Tap OK > The message is closed
■ ...	Identifies an item of a list
■ ...	Example: <ul style="list-style-type: none"> ■ TTL interface ■ EnDat interface ■ ...
Bold	Identifies menus, displays and buttons Example: <ul style="list-style-type: none"> ▶ Tap Shut down > The operating system shuts down. ▶ Turn the power switch off

2

Safety

2.1 Overview

This chapter provides important safety information needed for the proper operation of the unit.

2.2 General safety precautions

General accepted safety precautions, in particular the applicable precautions relating to the handling of live electrical equipment, must be followed when operating the system. Failure to observe these safety precautions may result in personal injury or damage to the product.

It is understood that safety rules within individual companies vary. If a conflict exists between the material contained in these instructions and the rules of a company using this system, the more stringent rules take precedence.

2.3 Intended use

The products of the POSITIP 8000 series are advanced digital readouts for use on manually operated machine tools. In combination with linear and angle encoders, digital readouts of the POSITIP 8000 series return the position of the tool in more than one axis and provide further functions for operating the machine tool.

The POSITIP 8000 NC1 software option can automate the production of a workpiece.

The products of this series

- must only be used in commercial applications and in an industrial environment
- must be mounted on a suitable stand or holder to ensure the correct and intended operation of the product
- are intended for indoor use in an environment in which the contamination caused by humidity, dirt, oil and lubricants complies with the requirements of the specifications



The products support the use of peripheral devices from different manufacturers. HEIDENHAIN cannot make any statements on the intended use of these devices. The information on their intended use, which is provided in the respective documentation, must be observed.

2.4 Improper use

In particular, the products of the POSITIP 8000 series must not be used in the following applications:

- Use and storage outside the operating conditions specified in "Specifications"
- Outdoor use
- Use in potentially explosive atmospheres
- Use of the products of the POSITIP 8000 series as part of a safety function

2.5 Personnel qualification

The personnel for mounting, installation, operation, service, maintenance and removal must be appropriately qualified for this work and must have obtained sufficient information from the documentation supplied with the product and with the connected peripherals.

The personnel required for the individual activities to be performed on the product are indicated in the respective sections of these instructions.

The personnel groups are specified in detail as follows with regard to their qualifications and tasks.



Operator

The operator uses and operates the product within the framework specified for the intended use. He is informed by the operating company about the special tasks and the potential hazards resulting from incorrect behavior.

Qualified personnel

The qualified personnel are trained by the operating company to perform advanced operation and parameterization. The qualified personnel have the required technical training, knowledge and experience and know the applicable regulations, and are thus capable of performing the assigned work regarding the application concerned and of proactively identifying and avoiding potential risks.

Electrical specialist

The electrical specialist has the required technical training, knowledge and experience and knows the applicable standards and regulations, and is thus capable of performing work on electrical systems and of proactively identifying and avoiding potential risks. Electrical specialists have been specially trained for the environment they work in.

Electrical specialists must comply with the provisions of the applicable legal regulations on accident prevention.

2.6 Obligations of the operating company

The operating company owns or leases the device and the peripherals. At all times, the operating company is responsible for ensuring that the intended use is complied with.

The operating company must:

- Assign the different tasks to be performed on the device to suitable, qualified and authorized personnel
- Verifiably train the personnel in the authorizations and tasks
- Provide all materials and means necessary in order for the personnel to complete the assigned tasks
- Ensure that the device is operated only when in perfect technical condition
- Ensure that the device is protected from unauthorized use

2.7 General safety precautions



 The safety of any system incorporating the use of this product is the responsibility of the assembler or installer of the system.

 The product supports the use of a wide variety of peripheral devices from different manufacturers. HEIDENHAIN cannot make any statements on the specific safety precautions to be taken for these devices. The safety precautions provided in the respective documentation must be observed. If there is no documentation at hand, it must be obtained from the manufacturers concerned.

The specific safety precautions required for the individual activities to be performed on the product are indicated in the respective sections of these instructions.

2.7.1 Symbols on the product

The following symbols are used to identify the product:

Symbol	Meaning
	Observe the safety precautions regarding electricity and the power connection before you connect the product.
	Functional ground connection as per IEC/EN 60204-1. Observe the information on installation.
	Product seal. Breaking or removing the product seal will result in forfeiture of warranty and guarantee.

2.7.2 Electrical safety precautions

WARNING

Hazard of contact with live parts when opening the product.

This may result in electric shock, burns or death.

- ▶ Never open the housing
- ▶ Only the manufacturer is permitted to access the inside of the product

WARNING

Hazard of dangerous amount of electricity passing through the human body upon direct or indirect contact with live electrical parts.

This may result in electric shock, burns or death.

- ▶ Work on the electrical system and live electrical components is to be performed only by trained specialists
- ▶ For power connection and all interface connections, use only cables and connectors that comply with applicable standards
- ▶ Have the manufacturer exchange defective electrical components immediately
- ▶ Regularly inspect all connected cables and all connections on the product. Defects, such as loose connections or scorched cables, must be removed immediately

NOTICE

Damage to internal parts of the product!

If you open the product, the warranty and the guarantee will become void.

- ▶ Never open the housing
- ▶ Only the product manufacturer is permitted to access the inside of the product

3

Basic Operation

3.1 Overview

This chapter describes the user interface, operating elements, and basic functions of the product.

3.2 Using the touchscreen and input devices

3.2.1 Touchscreen and input devices

The operating elements on the user interface of the unit are operated via a touchscreen or a connected USB mouse.

To enter data, you can use the screen keyboard of the touchscreen or a connected USB keyboard.

NOTICE

Malfunctions of the touchscreen caused by humidity or contact with water!

Humidity or water can impair the proper functioning of the touchscreen.

- ▶ Protect the touchscreen from humidity or contact with water

Further information: "Product data", Page 214

3.2.2 Gestures and mouse actions

To activate, switch or move the operating elements of the user interface, you can use the unit's touchscreen or a mouse. Gestures are used to operate the touchscreen and the mouse.

i The gestures for operating the touchscreen may differ from the gestures for operating the mouse.

If the gestures for operating the touchscreen differ from those for operating the mouse, then these instructions describe both operating options as alternative actions.

The alternative actions for operating the touchscreen or the mouse are identified by the following symbols:



Operation using the touchscreen



Operation using the mouse

The following overview describes the different gestures for operating the touchscreen or the mouse:

Tapping



Means touching the screen briefly with your fingertip



Means pressing the left mouse button once



The actions initiated by tapping include

- Selection of menus, features, or parameters
- Entering characters with the screen keyboard
- Closing dialogs

Holding (long press)



Means touching the screen and holding your finger(s) on it for a few seconds



Means pressing the left mouse button once and holding it down

The actions initiated by holding are

- Quickly changing the values in input fields with plus and minus buttons
- Activate multiple selection

Dragging



Is a combination of long press and then swipe, moving a finger over the touchscreen when at least the starting point of motion is defined



Means pressing the left mouse button once and holding it down while moving the mouse; at least the starting point of the motion is defined

The actions initiated by dragging include



- Scrolling through lists and texts

3.3 General operating elements and functions

The operating elements described below are available for configuration and operating the product via the touchscreen or input devices.

Screen keyboard

The screen keyboard enables you to enter text into the input fields of the user interface. Depending on the input field, a numeric or alphanumeric screen keyboard is shown.

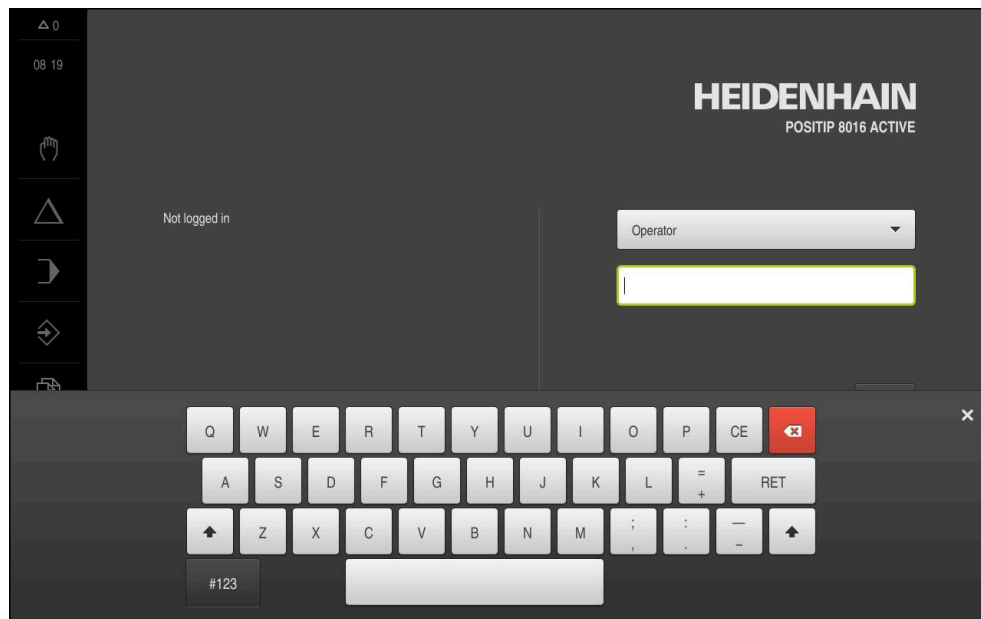

Figure 1: Screen keyboard

Using the screen keyboard

- ▶ To enter values, tap an input field
- > The input field is highlighted.
- > The screen keyboard is displayed.
- ▶ Enter text or numbers
- > If the entry is correct and complete, a green check mark is displayed as applicable.
- > If the entry is incomplete or the values are incorrect, a red exclamation mark is displayed as applicable. In this case, the entry cannot be completed.
- ▶ To apply the values, confirm the entry with **RET**
- > The values are displayed
- > The screen keyboard disappears.

Operating elements

Operating element	Function
-------------------	----------

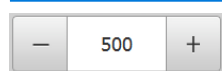







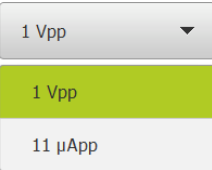

Input fields with plus and minus buttons

To adjust a numerical value, use the + (plus) and - (minus) buttons to the left and right of the numerical value.

- ▶ Tap + or - until the desired value is displayed
- ▶ Long-press + or - to scroll through the values more quickly
- > The selected value is displayed.



Operating element	Function
	<p>Toggle switch</p> <p>Use the toggle switch to switch between functions.</p> <ul style="list-style-type: none"> ▶ Tap the desired function > The active function is shown in green. > The inactive function is shown in light gray.
	<p>Slide switch</p> <p>Use the slide switch to activate or deactivate a function.</p> <ul style="list-style-type: none"> ▶ Drag the slider to the desired position or ▶ Tap the slide switch > The function is activated or deactivated.
	<p>Drop-down list</p> <p>Buttons that open drop-down lists are indicated by a triangle pointing down.</p> <ul style="list-style-type: none"> ▶ Tap the button > The drop-down list opens. > The active entry is highlighted in green. ▶ Tap the desired entry > The selected entry is applied.
Operating element	Function
	<p>Undo</p> <p>This button allows you to undo the last action. Processes that have already been concluded cannot be undone.</p> <ul style="list-style-type: none"> ▶ Tap Undo > The last action is undone.
	<p>Add</p> <ul style="list-style-type: none"> ▶ Tap Add to add a feature > The new feature is added.
	<p>Close</p> <ul style="list-style-type: none"> ▶ Tap Close to close a dialog
	<p>Confirm</p> <ul style="list-style-type: none"> ▶ Tap Confirm to conclude an action
	<p>Back</p> <ul style="list-style-type: none"> ▶ Tap Back to return to the higher level in the menu structure

3.4 POSITIP 8000 – switch-on and switch-off

3.4.1 Switching on the POSITIP 8000



Before using the product, you need to perform the commissioning and setup steps. Depending on the purpose of use, you may have to configure additional setup parameters.

Further information: "Commissioning", Page 81

- ▶ Turn the power switch on
The power switch is located on the rear side of the product
- > The unit powers up. This can take a moment.
- > If automatic user login is active and the last user who logged in was of the **Operator** type, the user interface opens with the **Manual operation** menu.
- > If automatic user login is not active, the **User login** menu is displayed.
Further information: "User login and logout", Page 25

3.4.2 Activating and deactivating the energy saving mode

If you will not be using the unit for a while, you should activate the energy-saving mode. This switches the unit to an inactive state without interrupting the power supply. The screen is switched off in this state.

Activating energy-saving mode



- ▶ Tap **Switch off** in the main menu



- ▶ Tap **Energy-saving mode**
- > The screen switches off.

Deactivating energy-saving mode



- ▶ Tap anywhere on the touchscreen
- > An arrow appears at the bottom of the screen.
- ▶ Drag the arrow up
- > The screen is switched on and shows the user interface last displayed.

3.4.3 Switching off the POSITIP 8000

NOTICE

Damage to the operating system!

Disconnecting the power source while the product is on can damage the operating system of the product.

- ▶ Use the **Switch-off** menu to shut down the product
- ▶ Do not disconnect the power source while the product is on
- ▶ Do not turn the power switch off until the product has shut down



- ▶ Tap **Switch off** in the main menu



- ▶ Tap **Shut down**
- > The operating system shuts down.
- ▶ Wait until the following message appears on the screen:
You can switch off the device now.
- ▶ Turn the power switch off

3.5 User login and logout

In the **User login** menu, you can log in and out of the product as a user.

Only one user can be logged in to the product at a time. The logged-in user is displayed. Before a new user can log in, the logged-in user has to log out.



The product provides various authorization levels that grant the user full or restricted access to management and operation functionality.

3.5.1 User login



- ▶ Tap **User login** in the main menu
- ▶ Select the user in the drop-down list
- ▶ Tap the **Password** input field
- ▶ Enter the user's password

User	Default password	Target group
OEM	oem	Commissioner, machine tool builder
Setup	setup	Setup engineer, system configurer
Operator	operator	Operator

Further information: "Logging in for the application example", Page 269



If a password other than the default password has been assigned to the user, ask a **Setup** or **OEM** user for the assigned password.
If the password is no longer known, contact a HEIDENHAIN service agency.



- ▶ Confirm entry with **RET**
- ▶ Tap **Log in**
- > The user is logged in and the is displayed.

Further information: "Target groups according to user types", Page 13

3.5.2 User logout



- ▶ Tap **User login** in the main menu



- ▶ Tap **Log out**
- > The user is logged out.
- > All functions of the main menu are inactive, except for **Switch off**.
- > The product can only be used again after a user has logged in.



3.6 Setting the language

The user interface language is English. You can change to another language, if desired.



- ▶ Tap **Settings** in the main menu



- ▶ Tap **User**
 - > The logged-in user is indicated by a check mark.
 - ▶ Select the logged-in user
 - > The language selected for the user is indicated by a national flag in the **Language** drop-down list.
 - ▶ Select the flag for the desired language from the **Language** drop-down list
 - > The user interface is displayed in the selected language.

3.7 Performing the reference mark search after startup

i If the product is configured with a **spindle axis S**, then you must define an upper limit for the spindle speed prior to a possible machining operation.
Further information: "Defining the upper limit for the spindle speed", Page 227

i If the reference mark search after unit start is active, then all of the unit's functions will be disabled until the reference mark search has been successfully completed.
Further information: "Reference marks (Encoder)", Page 97

i For encoders with EnDat interface, the reference mark search is omitted because the axes are referenced automatically.

If the reference mark search is active on the unit, then a wizard will ask you to traverse the reference marks of the axes.

- ▶ After logging in, follow the instructions of the wizard
- > The Reference symbol stops blinking upon successful completion of the reference mark search.

Further information: "Operating elements of the position display", Page 40

Further information: "Activating the reference mark search", Page 140

3.8 User interface

i The unit is available in different versions, which are variously equipped. The user interface and available functions may vary depending on the version.

3.8.1 User interface after switch-on

Factory default user interface

The figure shows the user interface in the product's factory default setting.

This user interface will also be displayed after the product has been reset to its factory default setting.

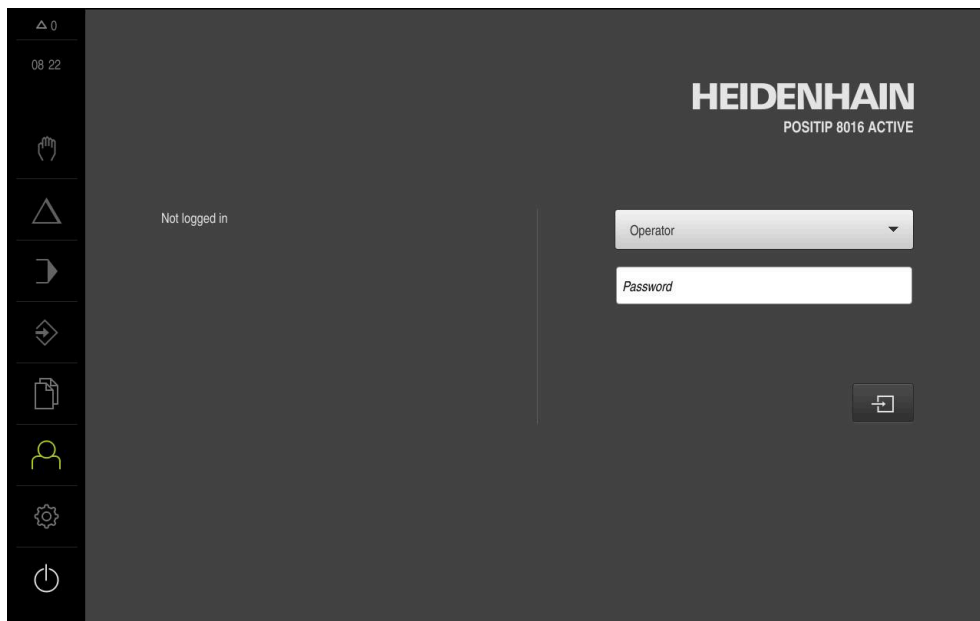

Figure 2: The user interface in the product's factory default setting

User interface after start-up

If automatic user login is activated, and the last user who logged in was of the **Operator** type, then the product displays the **Manual operation** menu after starting up.

Further information: "Manual operation menu", Page 31

If automatic user login is not activated, then the product opens the **User login** menu.

Further information: "User login menu", Page 38





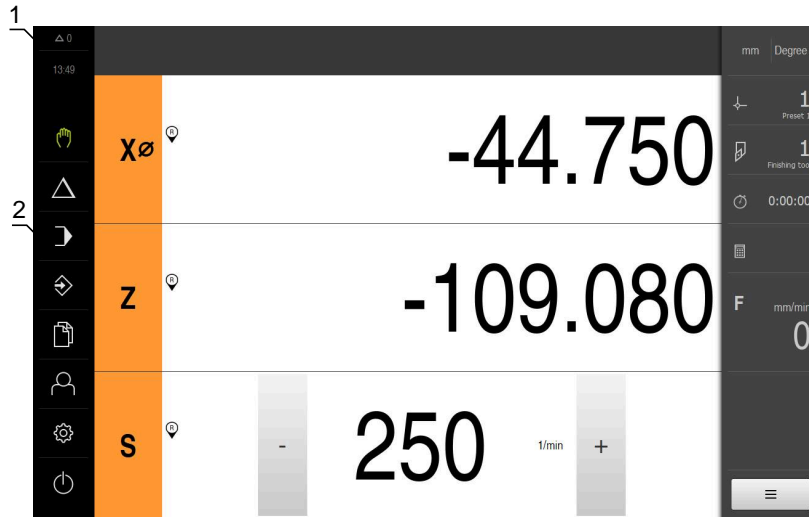

3.8.2 Main menu of the user interface



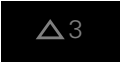

User interface (in Manual operation mode)



- 1 Message display area, displays the time and the number of unclosed messages
- 2 Main menu with operating elements

Main menu operating elements

Operating element	Function
	<p>Message Display of an overview of all messages as well as the number of messages that have not been closed Further information: "Messages", Page 51</p>
	<p>Manual operation Manual positioning of machine axes Further information: "Manual operation menu", Page 31</p>
	<p>MDI mode Direct input of the desired axis movements (Manual Data Input); the distance to go is calculated and displayed Further information: "MDI menu", Page 32</p>
	<p>Program run Execution of a previously created program with user interface Further information: "Program run menu ", Page 34</p>
	<p>Programming Creation and management of individual programs Further information: "Programming menu", Page 35</p>
	<p>File management Management of the files that are available on the product Further information: "File management menu", Page 37</p>

Operating element	Function
	<p>User login</p> <p>Login and logout of the user</p> <p>Further information: "User login menu", Page 38</p>
	<div style="border: 1px solid black; padding: 5px;"> <p> If a user with additional permissions (Setup or OEM user type) is logged in, then the gear symbol appears.</p> </div>
	<p>Settings</p> <p>Settings of the product, such as setting up users, configuring sensors, or updating the firmware</p> <p>Further information: "Settings menu", Page 39</p>
	<p>Switch-off</p> <p>Shutdown of the operating system or activation of power-saving mode</p> <p>Further information: "Switch-off menu", Page 40</p>

3.8.3 Manual operation menu

Call



- ▶ Tap **Manual operation** in the main menu
- > The user interface for Manual operation appears.

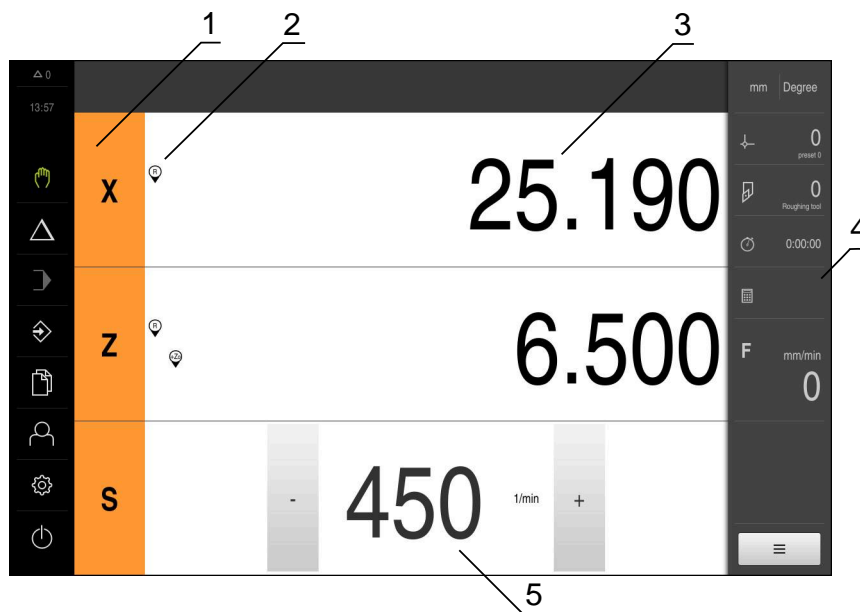

Figure 3: **Manual operation** menu

- 1 Axis key
- 2 Reference
- 3 Position display
- 4 Status bar
- 5 Spindle speed (machine tool)

In the **Manual operation** menu, the workspace shows the position values measured at the machine axes.

The status bar provides auxiliary functions.

Further information: "Manual operation", Page 225

3.8.4 MDI menu

Call



- ▶ Tap **MDI** in the main menu
- > The user interface for MDI mode is displayed.

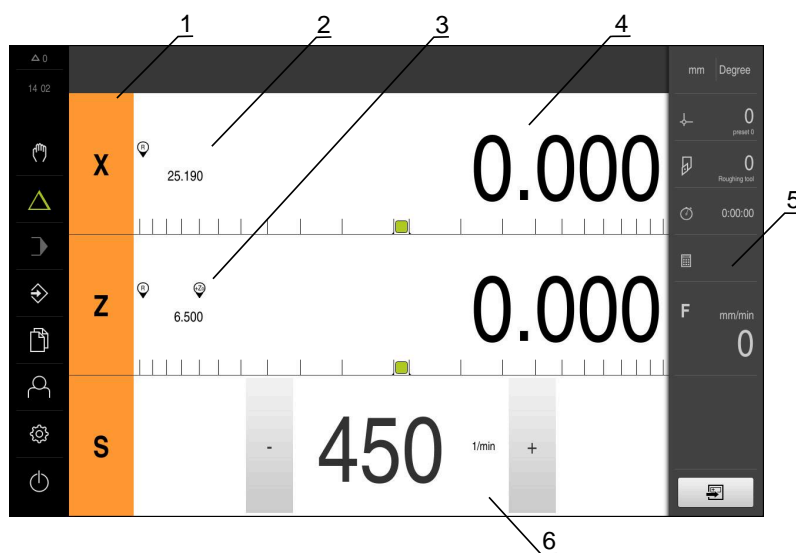

Figure 4: **MDI** menu

- 1 Axis key
- 2 Actual position
- 3 Coupled axes
- 4 Distance-to-go
- 5 Status bar
- 6 Spindle speed (machine tool)

MDI block dialog box



▶ Tap **MDI** in the main menu



▶ Tap **Create** on the status bar

➢ The user interface for MDI mode is displayed.

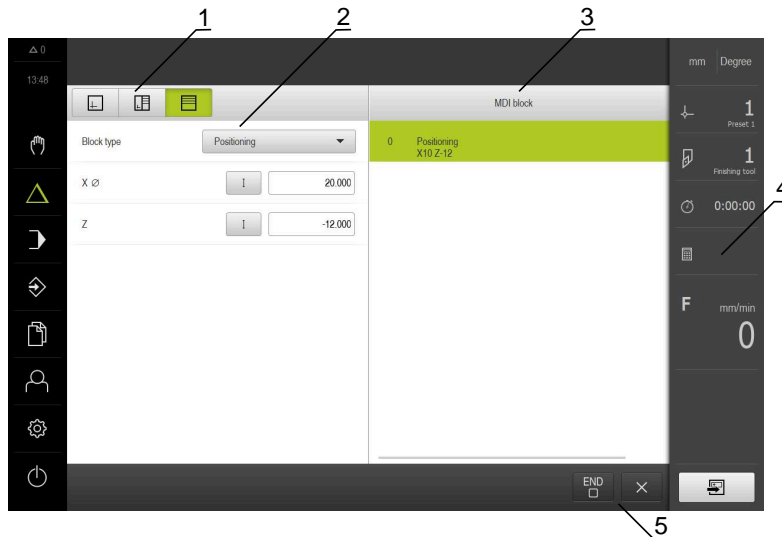

- 1 View bar
- 2 Block parameters
- 3 MDI block
- 4 Status bar
- 5 Block tools

The **MDI** (Manual Data Input) menu enables you to enter the desired axis movements directly. You specify the distance to the target point, and the distance to go is then calculated and displayed.

The status bar provides additional measured values and functions.

Further information: "MDI mode", Page 234

3.8.5 Program run menu

Call



- ▶ Tap **Program run** in the main menu
- > The user interface for Program Run is displayed.

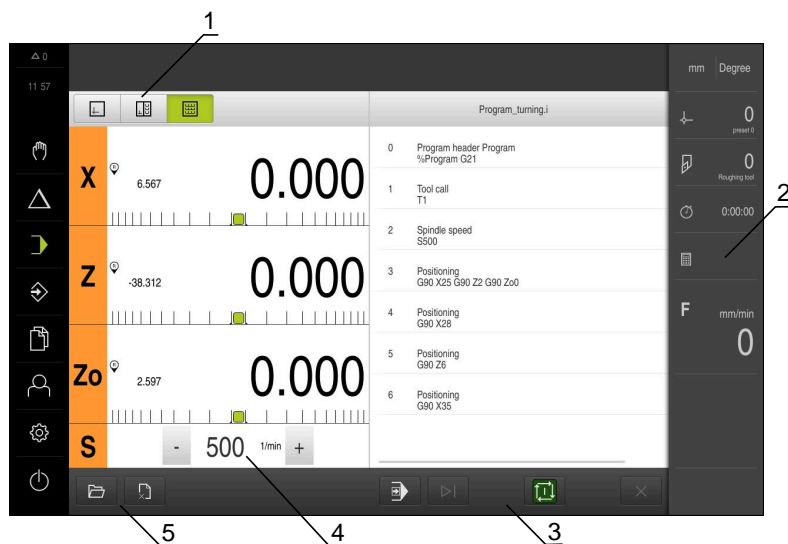

Figure 5: **Program run** menu

- 1 View bar
- 2 Status bar
- 3 Program control
- 4 Spindle speed (machine tool)
- 5 Program management

The **Program run** menu makes it possible to execute a program that has previously been created in the Programming operating mode. During execution, a wizard will guide you through the individual program steps.

In the **Program run** menu, you can display a simulation window that visualizes the selected block.

The status bar provides additional measured values and functions.

Further information: "Program run", Page 246

3.8.6 Programming menu

Activation



- ▶ Tap **Programming** in the main menu
- > The user interface for programming is displayed.

i The status bar and the optional OEM bar are not available in the **Programming** menu.



Figure 6: **Programming** menu

- 1 View bar
- 2 Toolbar
- 3 Program management

You can see a visualization of the selected block in the optional simulation window.

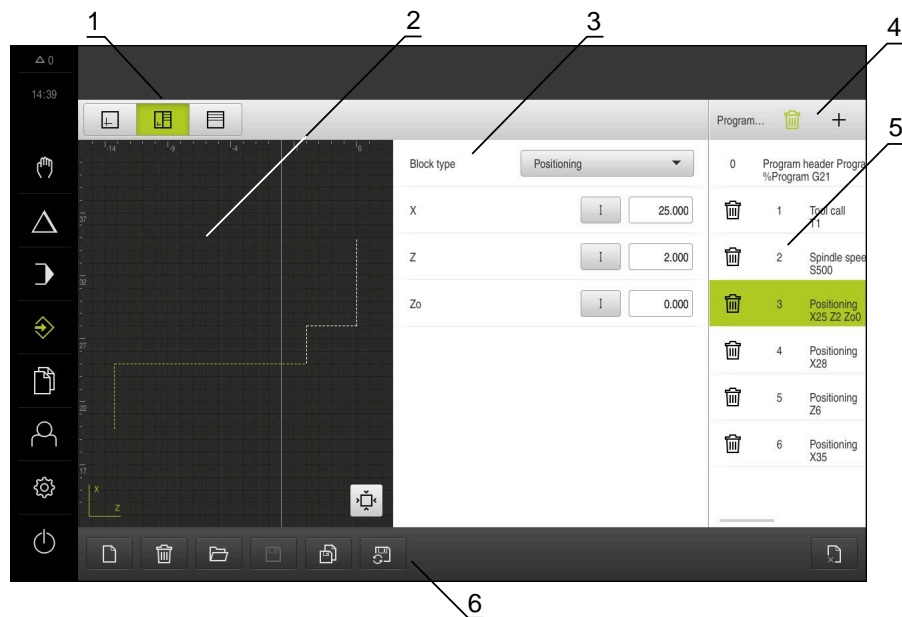

Figure 7: **Programming** menu with opened simulation window

- 1 View bar
- 2 Simulation window (optional)
- 3 Block parameters
- 4 Toolbar
- 5 Program blocks
- 6 Program management

In the **Programming** menu, you can create and manage programs. You define individual machining steps or machining patterns as blocks. A sequence of blocks then forms a program.

Further information: "Programming", Page 255

3.8.7 File management menu

Call



- ▶ Tap **File management** in the main menu
- > The file management user interface is displayed.

Short description

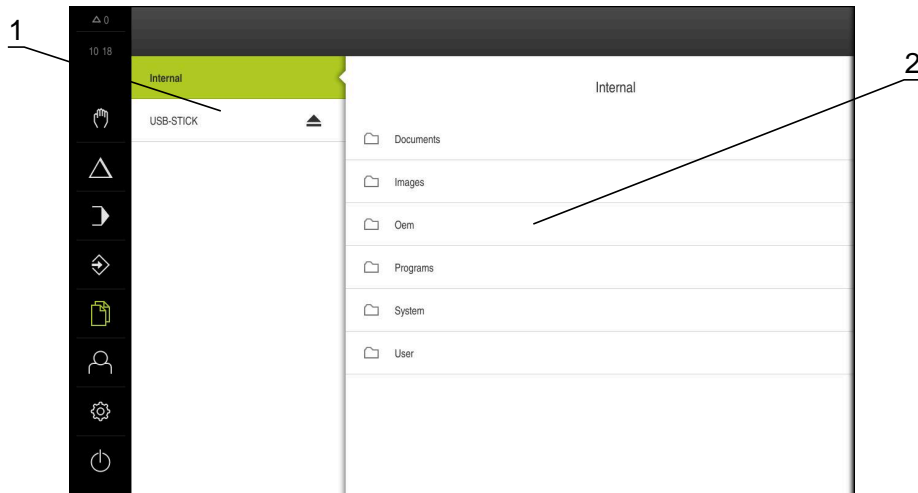

Figure 8: **File management** menu

- 1 List of available storage locations
- 2 List of folders in the selected storage location

The **File management** menu shows an overview of the files stored in the product's memory.

Any connected USB mass storage devices (FAT32 format) or available network drives are shown in the list of storage locations. The USB mass storage devices and the network drives are displayed with their name or drive designation.

Further information: "File Management", Page 173

3.8.8 User login menu

Call



- ▶ Tap **User login** in the main menu
- > The user interface for user login and logout is displayed.

Short description

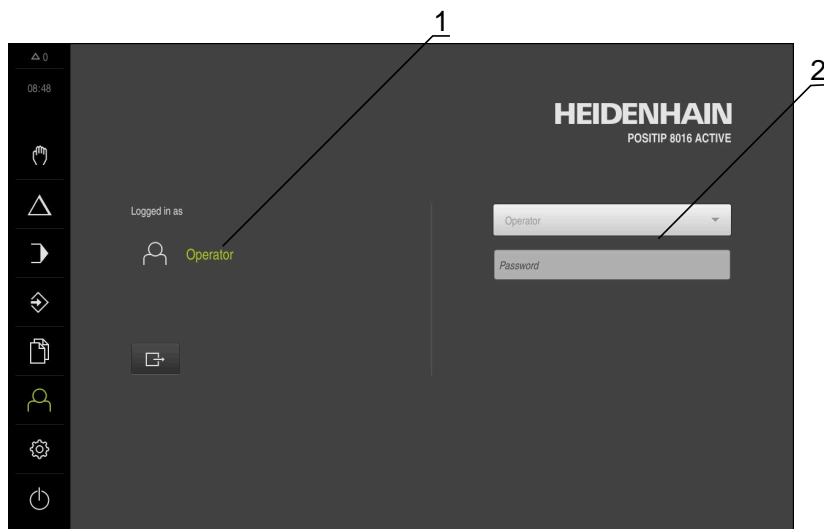

Figure 9: **User login** menu

- 1 Display of the logged-in user
- 2 User login

The **User login** menu shows the logged-in user in the column on the left. The login of a new user is displayed in the right-hand column.

To log in another user, the logged-in user must first log out.

Further information: "User login and logout", Page 25

3.8.9 Settings menu

Call



- ▶ Tap **Settings** in the main menu
- > The user interface for the product settings is displayed.

Short description

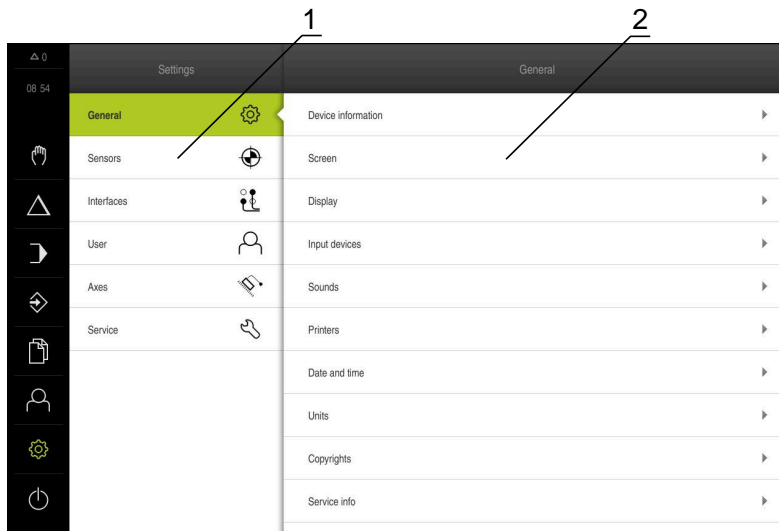

Figure 10: **Settings** menu

- 1 List of setting options
- 2 List of setting parameters

The **Settings** menu shows all of the options for configuring the product. The settings parameters allow you to adapt the product to on-site requirements.

Further information: "Settings", Page 180



The product provides various authorization levels that grant the user full or restricted access to management and operation functionality.

3.8.10 Switch-off menu



Call



- ▶ Tap **Switch off** in the main menu
- The operating elements for shutting down the operating system, for activating the energy-saving mode and for activating the cleaning mode are displayed.

Short description

The **Switch off** menu provides the following options:

Operating element	Function
	Shut down Shuts down the operating system
	Energy saving mode Switches the screen off and puts the operating system into energy-saving mode
	Cleaning mode Switches the screen off; the operating system continues unchanged

Further information: "POSITIP 8000 – switch-on and switch-off", Page 24





Further information: "Cleaning the screen", Page 200

3.9 Position display

The unit's position display shows the axis positions and additional information about the configured axes (if applicable).

You can also couple the display of axes and have access to the spindle functions.

3.9.1 Operating elements of the position display

Symbol	Meaning
	Axis key Axis key functions: <ul style="list-style-type: none"> ■ Tapping the axis key: opens the input field for position value (Manual operation) or dialog box MDI block (MDI mode) ■ Holding down the axis key: sets the current position as zero point ■ Dragging the axis key to the right: opens menu if functions are available for the axis
	Position display shows the diameter of the radial machining axis X Further information: "Display", Page 184
	Reference mark search performed successfully
	Reference mark search not performed or no reference mark detected



Symbol	Meaning
	Zo axis is coupled with the Z axis. Position display shows the sum of both position values Further information: "Coupling axes", Page 41 <div style="border: 1px solid black; padding: 5px; margin-top: 5px;"> Only the Zo axis can be coupled to the Z axis.</div>
	Selected gear stage of the gear spindle Further information: "Setting the gear stage for gear spindles", Page 43
	Spindle speed cannot be achieved with selected gear stage ▶ Select a higher gear stage
	Spindle speed cannot be achieved with selected gear stage ▶ Select a lower gear stage
	The CSS (constant surface speed) spindle mode is activated Further information: "Setting the spindle mode", Page 44 If the icon is flashing, then the calculated spindle speed lies outside of the defined speed range. The desired surface speed cannot be attained. The spindle will continue to turn at the maximum or minimum speed
	In MDI mode and Program Run , a scaling factor is applied to the axis Further information: "Adjusting settings in the quick access menu", Page 46
	Axis is feedback-controlled
1250 <small>100%</small>	Actual spindle speed
	Input field for controlling the spindle speed Further information: "Setting the spindle speed", Page 42
	Virtual axis keys for operating NC axes

3.9.2 Position display functions

Coupling axes

You can couple the display of the axes **Zo** and **Z**. For coupled axes, the position display in the **Z** axis shows the sum of the position values of both axes.

If the **Z** axis and the **Zo** axis have been coupled, the Program run operating mode is disabled.

All of the other axes can be coupled in the menu.
Further information: "Coupling axes", Page 136

Coupling axes



- ▶ In the working space, drag the **Z axis key** to the right



- ▶ Tap **Couple**
- > The **Zo** axis is coupled with the **Z** axis.



- > The icon for the coupled axes appears next to the **axis key Z**.
- > The position value for the coupled axes is shown as a sum.

Decoupling axes



- ▶ In the working space, drag the **Z axis key** to the right



- ▶ Tap **Decouple**
- > The shown sum value is applied to the **Z** axis.
- > Axis **Zo** is set to 0.

Example: Coupling axes

The figure below shows the position values before, during and after coupling the axes **Z** and **Zo**.

Xø	19.250	Zo 	Xø	19.250	Zo 	Xø	19.250
Zo	-5.000		Z	-15.000		Zo	0.000
Z	-10.000		Z	-15.000		Z	-15.000

Axes **Zo** and **Z** not coupled.

Zo is coupled to axis **Z**.
The sum of both axes is shown in **Z**.

Zo is decoupled from axis **Z**.
The sum continues to be shown in axis **Z**.
Axis **Zo** is set to 0.

Setting the spindle speed

You can control the spindle speed depending on the configuration of the connected machine tool.

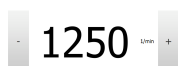

- ▶ To switch from the display of the spindle speed to the input field (if required), drag the display to the right.
- > The **Spindle speed** input field is displayed.
- ▶ Tap or long-press **+** or **-** to set the spindle speed to the desired value
- or
- ▶ Tap the **Spindle speed** input field
- ▶ Enter the desired value
- ▶ Confirm entry with **RET**
- > The product applies the entered spindle speed as the nominal value and controls the spindle of the machine tool accordingly.
- ▶ To return to the display of the actual spindle speed, drag the input field to the left



Setting the gear stage for gear spindles

If your machine tool uses a gear spindle, then you can select the gear stage used.



The selection of the gear stages can also be controlled via an external signal.

Further information: "Spindle axis S", Page 127



▶ In the working space, drag the **S axis key** to the right



▶ Tap **Gear stage**

> The **Set gear stage** dialog box appears.

▶ Tap the desired gear stage



▶ Tap **Confirm**

> The selected gear stage is now adopted as the new value.

▶ Drag the **S axis key** to the left



> The icon for the selected gear stage appears next to the **S axis key**.







If the desired spindle speed cannot be attained with the selected gear stage, then the gear stage icon will flash with an upward pointing arrow (higher gear stage) or with a downward pointing arrow (lower gear stage).

Setting the spindle mode



For spindle mode, you can decide whether the product uses the standard speed mode or **CSS** (constant surface speed).

In the **CSS** spindle mode, the unit calculates the spindle speed such that the surface speed of the turning tool remains constant regardless of the workpiece geometry.

Activating the CSS spindle mode

-  ▶ In the working space, drag the **S axis key** to the right
-  ▶ Tap **CSS mode**
 - The **Activate CSS** dialog box appears.
 - ▶ Enter the value for **Maximum spindle speed**
-  ▶ Tap **Confirm**
 - The **CSS** spindle mode is activated.
 - The spindle speed is shown in the unit of measure **m/min**.
-  ▶ Drag the **S axis key** to the left
 - The icon for the **CSS** spindle mode appears next to the **S axis key**.



Activating the speed mode

-  ▶ In the working space, drag the **S axis key** to the right
-  ▶ Tap **Speed mode**
 - The **Activate speed mode** dialog box appears.
 - ▶ Enter the value for **Maximum spindle speed**
-  ▶ Tap **Confirm**
 - The speed mode is activated.
 - The spindle speed is shown in the unit of measure **rpm**.
- ▶ Drag the **S axis key** to the left

Traversing with virtual axis keys

If virtual axis keys have been configured on the device, you can move the NC axes with them.

Example: Negative traverse with Y axis

-  ▶ In the working space, drag the **Y axis key** to the right
 - The operating elements **minus** and **plus** are displayed.
-  ▶ If necessary, press the key for enabling the axis keys (only if configured)
 - ▶ Long-press **minus**



Depending on the configuration, the virtual axis keys are either buttons (long-press) or switches (tap).

- The Y axis moves in negative direction.





3.10 Status bar

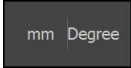

 The status bar and the optional OEM bar are not available in the **Programming** menu.

In the status bar, the product shows the feed rate and traversing speed. The operating elements of the status bar also give you direct access to the preset table and tool table, as well as to the stopwatch and calculator features.

3.10.1 Operating elements of the status bar

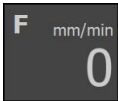
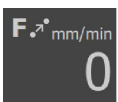
The status bar provides the following operating elements:

Operating element	Function
	<p>Quick access menu</p> <p>Setting of the units for linear values and angular values, configuration of a scaling factor, configuration of the position display for radial machining axes; tapping opens the quick access menu</p> <p>Further information: "Adjusting settings in the quick access menu", Page 46</p>
	<p>Preset table</p> <p>Display of the current preset; tapping opens the preset table</p> <p>Further information: "Creating a preset table", Page 169</p>
	<p>Tool table</p> <p>Display of the current tool; tapping opens the tool table</p> <p>Further information: "Creating a tool table", Page 167</p>
	<p>Stopwatch</p> <p>Time display with Start / Stop function in h:mm:ss format</p> <p>Further information: "Stopwatch", Page 48</p>
	<p>Calculator</p> <p>Calculator with the most important mathematical functions, speed calculator and taper calculator</p> <p>Further information: "Calculator", Page 48</p>
	<p>Feed rate</p> <p>Display of the current feed rate of the fastest linear axis</p> <p>If all linear axes are at a standstill, the feed rate of the fastest rotational axis is shown</p> <p>In Manual operation and MDI mode, you can set the feed-rate value; tap to open the dialog</p>
	<p>Jog increment</p> <p>Entering the jog increment and activating the jog increment function in Manual operation mode; tap to open the dialog</p> <p>If this function is active, a corresponding icon is shown</p>

Operating element	Function
	<p>Override</p> <p>Display of the changed traversing speed of the fastest linear axis.</p> <p>If all linear axes are at a standstill, the changed traversing speed of the fastest rotational axis is displayed</p> <p>The change is made using an external controller on an NC-controlled machine tool</p>
	<p>Auxiliary functions</p> <p>Auxiliary functions in Manual operation mode</p> <p>Further information: "Additional functions in Manual operation mode", Page 49</p>
	<p>MDI block</p> <p>For creating machining blocks in MDI mode</p>



3.10.2 Adjusting settings in the quick access menu

With the quick access menu, you can adjust the following settings:

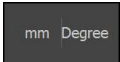

 The availability of settings in the quick access menu depends on which user is logged in.

- Unit for linear values (**Millimeters** or **Inch**)
- Unit for angular values (**Radian**, **Decimal degrees** or **Deg-Min-Sec**)
- Display of **Radial machining axes** (**Radius** or **Diameter**)
- The **Scaling factor** by which the stored position is multiplied during execution of an **MDI block** or **program block**

Setting units

- 
- ▶ Tap the **quick access menu** on the status bar
 - ▶ Select the desired **Unit for linear values**
 - ▶ Select the desired **Unit for angular values**
- 
- ▶ Tap **Close** to close the quick access menu
 - ▶ The selected units are displayed in the **quick access menu**.

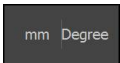
Activating the display of Radial machining axes

- 
- ▶ Tap the **quick access menu** on the status bar
 - ▶ Select the desired option
 - ▶ Tap **Close** to close the quick access menu
- 
- ▶ If the **Diameter** option is selected, then the corresponding icon appears in the position display.
- 

Activating Scaling factor

While an **MDI block** or a **program block** is executing, the position stored in the block is multiplied by the **Scaling factor**. This allows you to mirror or scale an **MDI block** or **program block** on one or more axes, without changing the block.

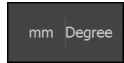

- ▶ Tap the **quick access menu** on the status bar
- ▶ To navigate to the desired setting, drag the view to the left
- ▶ Activate **Scaling factor** with the **ON/OFF** slide switch
- ▶ Enter the desired **Scaling factor** for each axis
- ▶ Confirm each entry with **RET**
- ▶ To close the quick access menu, tap **Close**



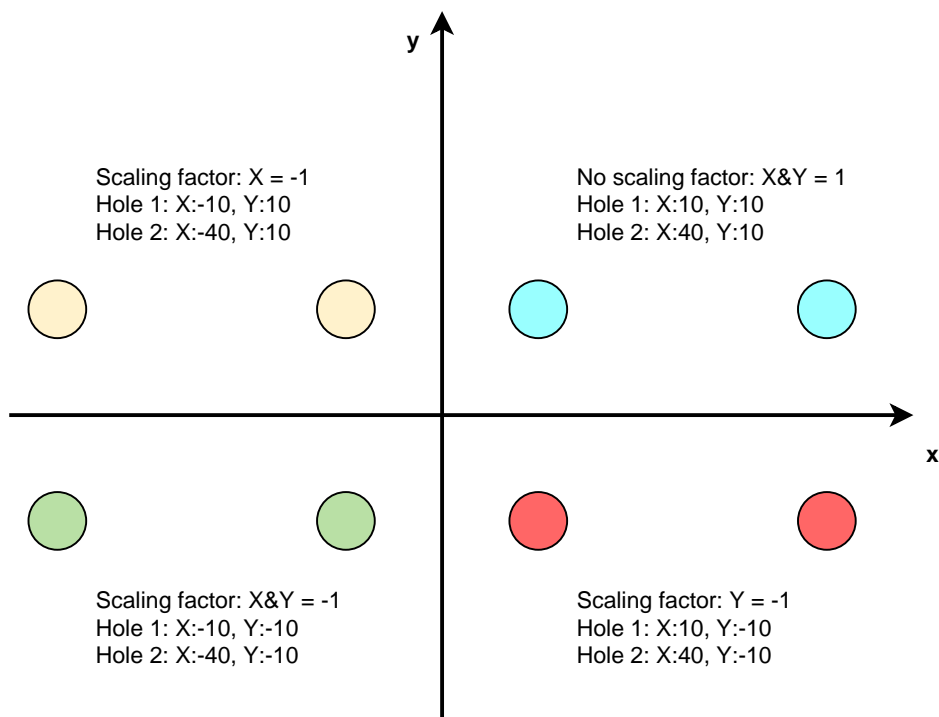

- > For an active scaling factor $\neq 1$, the corresponding symbol appears in the position display.

Example: Using a scaling factor for mirroring



3.10.3 Stopwatch

The status bar provides a stopwatch for measuring the machining times, etc. The stopwatch uses the time display format h:mm:ss and operates on the same principle as a standard stopwatch, i.e. it measures elapsed time.

Operating element	Function
	Start Starts time measurement or resumes time measurement after Pause
	Pause Interrupts time measurement
	Stop Stops time measurement and resets it to 0:00:00

3.10.4 Calculator

For calculations, the product provides various calculators in the status bar. To enter the numerical values, use the numeric keys as on a normal computer.

Calculator	Function
Standard	Contains the most important mathematical functions
Speed calculator	<ul style="list-style-type: none"> ▶ Enter the Diameter (mm) and Cutting speed (m/min) in the provided fields > The speed is calculated automatically.
Taper calculator	<ul style="list-style-type: none"> ▶ Enter D1, D2, and L in the provided fields > The angle is calculated automatically. > The taper is displayed graphically.

3.10.5 Setting the feed-rate value

Setting the feed-rate value

For **Manual operation** and **MDI mode**, you can set the feed-rate value in the **Feed rate** dialog.

Dialog	Function
	<ul style="list-style-type: none"> ▶ Tap Feed rate on the status bar <ul style="list-style-type: none"> ■ For linear axes, use the input fields for mm/rev and mm/min ■ For rotational axes, use the °/min input field
<p>i When the spindle is rotating, the linear axes are moved depending on the spindle speed. The device uses the value given in the mm/rev input field. If the spindle is at standstill, the device uses the value from the mm/min input field.</p>	



3.10.6 Entering and activating the jog increment

Entering and activating the jog increment



In **Manual operation** mode, you can enter and activate a jog increment via the **Feed rate/Jog increment** dialog.

Dialog	Function
	<ul style="list-style-type: none"> ▶ Tap Feed rate /Jog increment on the status bar ▶ Activate the jog increment with the ON/OFF slide switch <ul style="list-style-type: none"> ■ For linear axes, use the input fields for mm/rev and mm/min ■ For rotational axes, use the jog increment ° input field

3.10.7 Additional functions in Manual operation mode

- 
 - ▶ To call the additional functions, tap **Additional functions** in the status bar

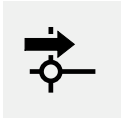
The following operating elements are available:

Operating element	Function
	<p>Reference marks For starting the reference mark search Further information: "Activating the reference mark search", Page 140</p>
	<p>Presets Setting presets Further information: "Touching off presets", Page 170</p>
	<p>Tool data For tool setting (touch-off) Further information: "Calibrating a tool", Page 168</p>

3.11 OEM bar



 The status bar and the optional OEM bar are not available in the **Programming** menu.

Depending on the configuration, the optional OEM bar enables you to control the functions of the connected machine tool.

3.11.1 Operating elements of the OEM bar

i The operating elements that are available on the OEM bar depend on the configuration of the device and of the connected machine tool.
Further information: "Configuring the OEM bar", Page 142

The following operating elements are typically available in the **OEM bar**:

Operating element	Function
	Logo Displays the configured OEM logo
	Spindle speed Shows one or more default values for the spindle speed Further information: "Configuring nominal values for the spindle speed", Page 144

3.11.2 Calling functions of the OEM bar

i The operating elements that are available on the OEM bar depend on the configuration of the device and of the connected machine tool.
Further information: "Configuring the OEM bar", Page 142

The operating elements in the OEM bar allow you to control special functions (e.g., spindle functions).

Further information: "Configuring special functions", Page 146

Setting spindle speed



- ▶ Tap the **Spindle speed** field on the OEM bar
- The product applies the predefined voltage value at which the spindle of the connected machine tool is brought to the selected rotational speed (with no load on the spindle).

Programming spindle speed



- ▶ Tap or long-press + or - to bring the spindle to the desired rotational speed



- ▶ Press and hold the desired **Spindle speed** field on the OEM bar
- The background color of the field is highlighted in green.
- The product applies the current spindle speed as the nominal value and displays it in the **Spindle speed** field.

3.12 Messages and audio feedback

3.12.1 Messages

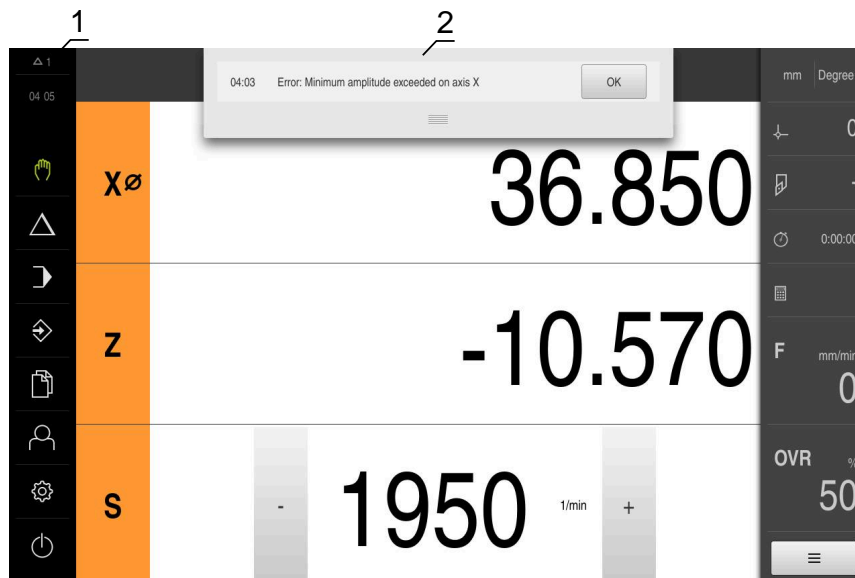

- 1 Message display area
- 2 Message list

The messages that appear at the top of the workspace are triggered by, for example, operator errors or uncompleted processes.

The messages are displayed upon occurrence of the message cause or via tapping on the **Messages** display area at the top left of the screen.

Viewing messages

- ▶ Tap **Messages**
- > The message list opens.

Resizing the display area

- ▶ To enlarge the message display area, drag the **handle** down
- ▶ To make the message display area smaller, drag the **handle** up
- ▶ To close the display area, drag the **handle** up out of the screen
- > The number of messages that have not been closed is indicated in **Messages**.

Closing messages

Depending on the content of the messages, you can close messages by means of the following operating elements:



- ▶ To close an informational message, tap **Close**
- > The message disappears.

or

- ▶ To close a message that potentially has an effect on the application, tap **OK**
- > If applicable, the message will now be taken into account by the application.
- > The message disappears.



3.12.2 Wizard

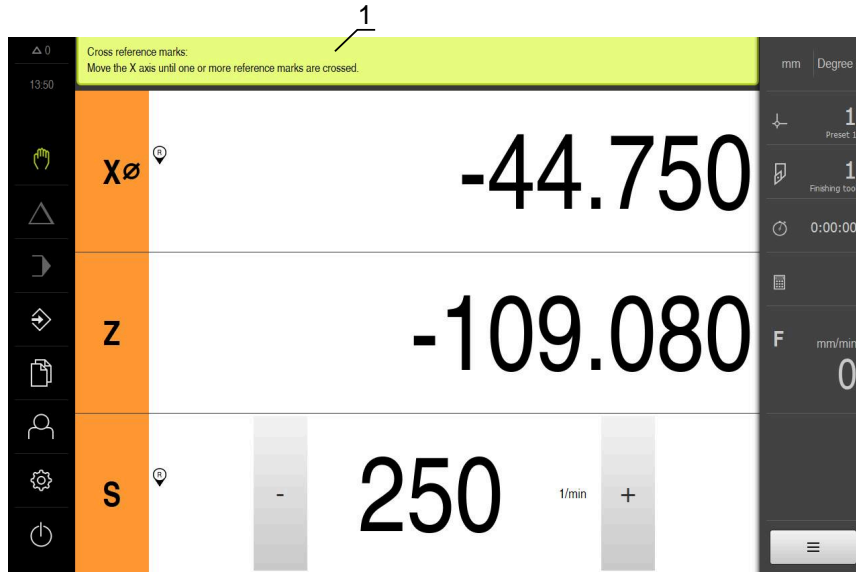







Figure 11: Support from the wizard for action steps

1 Wizard (example)

The wizard supports you when you are performing actions and teach sequences or when you are running programs.

The following operating elements of the wizard are shown based on the action step or process.

- 
 - ▶ To return to the last action step or to repeat the process, tap **Undo**
- 
 - ▶ To confirm the displayed action step, tap **Confirm**
 - ▶ The wizard proceeds to the next step or completes the process.
- 
 - ▶ Tap **Next** to proceed to the next step
- 
 - ▶ Tap **Back** to return to the previous step
- 
 - ▶ Tap **Close** to close the wizard

3.12.3 Audio feedback

The product can provide audio feedback to indicate user actions, completed processes or malfunctions.

The available sounds are grouped into categories. The sounds differ within a category.

You can define the audio feedback settings in the **Settings** menu.

Further information: "Sounds", Page 187

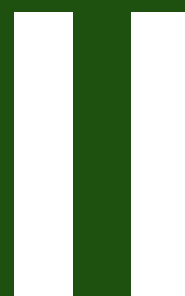

**Information for OEM
and Setup Users**

Overview

This part of the documentation contains important information for the OEM and Setup users to enable them to put the product into service and set it up properly.

Contents of chapters in the "Information for OEM and Setup Users" part

The table below shows:

- The chapters included in this "Information for OEM and Setup Users" part
- The information contained in these chapters
- The target groups that these chapters are mainly intended for

Chapter	Contents	Target group		
		OEM	Setup	Operator
	This chapter contains information about...			
1 "Transport and Storage"	... transporting the product ... storing the product ... items supplied with the product ... accessories for the product	✓	✓	
2 "Mounting"	... correct mounting of the product	✓	✓	
3 "Installation"	... correct installation of the product	✓	✓	
4 "Commissioning"	... commissioning the product	✓		
5 "Setup"	... correct setup of the product		✓	
6 "File Management"	... the functions of the "File management" menu	✓	✓	✓
7 "Settings"	... setting options and associated setting parameters for the product	✓	✓	✓
8 "Servicing and Maintenance"	... general maintenance work on the product	✓	✓	✓
9 "Removal and Disposal"	... removal and disposal of the product ... environmental protection specifications	✓	✓	✓
10 "Specifications"	... the technical data of the product ... product dimensions and mating dimensions (drawings)	✓	✓	✓

Contents

1	Transport and Storage.....	60
1.1	Overview.....	61
1.2	Unpacking.....	61
1.3	Items supplied and accessories.....	61
1.3.1	Items supplied.....	61
1.3.2	Accessories.....	62
1.4	In case of damage in transit.....	63
1.5	Repackaging and storage.....	63
1.5.1	Repackaging the product.....	64
1.5.2	Storage of the product.....	64
2	Mounting.....	65
2.1	Overview.....	66
2.2	Assembly of the product.....	66
2.2.1	Mounting on Single-Pos stand.....	67
2.2.2	Mounting on Duo-Pos stand.....	68
2.2.3	Mounting on Multi-Pos stand.....	69
2.2.4	Mounting on Multi-Pos holder.....	70
3	Installation.....	71
3.1	Overview.....	72
3.2	General information.....	72
3.3	Device overview.....	73
3.4	Connecting encoders.....	75
3.5	Wiring switching inputs and outputs.....	76
3.6	Connecting input devices.....	79
3.7	Connecting a network peripheral.....	79
3.8	Connecting the line voltage.....	80
4	Commissioning.....	81
4.1	Overview.....	82
4.2	Logging in for commissioning.....	82
4.2.1	User login.....	82
4.2.2	Performing the reference mark search after startup.....	83
4.2.3	Setting the language.....	83
4.2.4	Changing the password.....	84
4.3	Steps for commissioning.....	84
4.4	Selecting the Application.....	86
4.5	Basic settings.....	86
4.5.1	Activating Software options.....	86
4.5.2	Setting the date and time.....	89
4.5.3	Setting the units of measure.....	89
4.6	Configuring the axes.....	90
4.6.1	Fundamentals of axis configuration.....	91
4.6.2	Overview of typical encoders.....	92
4.6.3	Configuring axes for encoders with EnDat interface.....	93
4.6.4	Configuring the axes for encoders with a 1 V _{PP} or 11 μA _{PP} interface.....	94
4.6.5	Performing error compensation.....	99

4.6.6	Configuring the central drive.....	104
4.6.7	Configuring specific settings for Axis + NC.....	110
4.6.8	Configuring general settings for Axis + NC.....	121
4.6.9	Configuring the spindle axis.....	126
4.6.10	Configuring an Electronic handwheel.....	134
4.6.11	Coupling axes.....	136
4.6.12	Diameter axis.....	137
4.6.13	Configuring thread cutting (NC software option).....	138
4.6.14	Reference marks.....	139
4.7	Configuring M functions.....	140
4.7.1	Standard M functions.....	141
4.7.2	Manufacturer-specific M functions.....	141
4.8	OEM area.....	141
4.8.1	Adding documentation.....	142
4.8.2	Adding a startup screen.....	142
4.8.3	Configuring the OEM bar.....	142
4.8.4	Adjusting the display.....	148
4.8.5	Adjusting the program execution.....	148
4.8.6	Defining error messages.....	150
4.8.7	Backing up and restoring OEM settings.....	151
4.8.8	Configuring the unit for screenshots.....	152
4.9	Backing up data.....	153
4.9.1	Back up settings.....	153
4.9.2	Back up user files.....	154
5	Setup.....	155
5.1	Overview.....	156
5.2	Logging in for setup.....	156
5.2.1	User login.....	156
5.2.2	Performing the reference mark search after startup.....	157
5.2.3	Setting the language.....	157
5.2.4	Changing the password.....	158
5.3	Single steps for setup.....	159
5.3.1	Basic settings.....	159
5.3.2	Preparing machining processes.....	167
5.4	Back up settings.....	171
5.5	Back up user files.....	172
6	File Management.....	173
6.1	Overview.....	174
6.2	File types.....	175
6.3	Managing folders and files.....	175
6.4	Viewing files.....	178
6.5	Exporting files.....	178
6.6	Importing files.....	179
7	Settings.....	180
7.1	Overview.....	181
7.2	General.....	182
7.2.1	Device information.....	182
7.2.2	Screen.....	183
7.2.3	Display.....	184
7.2.4	Simulation window.....	185

- 7.2.5 User interface..... 186
- 7.2.6 Sounds..... 187
- 7.2.7 Printers..... 187
- 7.2.8 Copyrights..... 187
- 7.2.9 Service info..... 187
- 7.2.10 Documentation..... 188
- 7.3 Interfaces..... 189
 - 7.3.1 USB..... 189
 - 7.3.2 Axes (switching functions)..... 189
 - 7.3.3 Position-dependent switching functions..... 189
- 7.4 User..... 191
 - 7.4.1 OEM..... 191
 - 7.4.2 Setup..... 191
 - 7.4.3 Operator..... 192
- 7.5 Axes..... 193
 - 7.5.1 Information..... 195
- 7.6 Service..... 196
 - 7.6.1 Firmware information..... 197

8 Servicing and Maintenance..... 199

- 8.1 Overview..... 200
- 8.2 Cleaning..... 200
- 8.3 Maintenance plan..... 201
- 8.4 Resuming operation..... 201
- 8.5 Updating the firmware..... 201
- 8.6 Encoder diagnostics..... 203
 - 8.6.1 Diagnostics for encoders with 1 V_{PP}/11 μA_{PP} interface..... 203
 - 8.6.2 Diagnostics for encoders with EnDat interface..... 204
- 8.7 Restoring files and settings..... 206
 - 8.7.1 Restore OEM-specific folders and files..... 207
 - 8.7.2 Restore user files..... 208
 - 8.7.3 Restoring settings..... 209
- 8.8 Reset all settings..... 210
- 8.9 Reset to shipping conditions..... 210

9 Removal and Disposal..... 211

- 9.1 Overview..... 212
- 9.2 Removal..... 212
- 9.3 Disposal..... 212

10 Specifications..... 213

- 10.1 Overview..... 214
- 10.2 Product data..... 214
- 10.3 Product dimensions and mating dimensions..... 216
 - 10.3.1 Product dimensions with Single-Pos stand..... 218
 - 10.3.2 Product dimensions with Duo-Pos stand..... 218
 - 10.3.3 Product dimensions with Multi-Pos stand..... 219
 - 10.3.4 Product dimensions with Multi-Pos holder..... 219

1

**Transport and
Storage**

1.1 Overview

This chapter contains information on the transportation and storage of the product and provides an overview of the items supplied and the available accessories for the product.



The following steps must be performed only by qualified personnel.

Further information: "Personnel qualification", Page 16

1.2 Unpacking

- ▶ Open the top lid of the box
- ▶ Remove the packaging materials
- ▶ Unpack the contents
- ▶ Check the delivery for completeness
- ▶ Check the delivery for damage

1.3 Items supplied and accessories

1.3.1 Items supplied

The following items are included in delivery:

Name	Description
Addendum (optional)	Supplements or supersedes the contents of the Operating Instructions and, if applicable, of the Installation Instructions.
Operating Instructions	PDF issue of the Operating Instructions on a memory medium in the currently available languages
Product	Digital Readout POSITIP 8000
Installation Instructions	Printed issue of the Installation Instructions in the currently available languages
Single-Pos stand	Stand for rigid mounting, inclination angle 20°, fixing hole pattern 100 mm x 100 mm

1.3.2 Accessories



Software options need to be enabled on the product via a license key. Before you can use the associated hardware components, you need to enable the respective software option.

Further information: "Activating Software options", Page 86

The following accessories are optionally available and can be ordered from HEIDENHAIN:

Accessories	Name	Description	ID
For installation			
	Adapter connector for 1 Vpp	Conversion of the 1 V _{PP} interface from installation in D-sub connector, 2-row, male, 15-pin to D-sub connector, 2-row, with locking screws, male, 15-pin	1089214-01
	Cables	For information on connecting cables, see "Cables and Connectors for HEIDENHAIN Products" brochure.	---
	Power cable	Power cable with European plug (type F), length: 3 m	223775-01
	TS 248 touch probe	Touch probe for probing a workpiece (for setting presets), axial cable outlet	683110-xx
	TS 248 touch probe (radial)	Touch probe for probing a workpiece (for setting presets), radial cable outlet	683112-xx
	USB connecting cable	USB connecting cable for connector type A to type B	354770-xx
For mounting			
	Duo-Pos stand	Stand for rigid mounting, inclination angle 20° or 45°, fixing hole pattern 100 mm x 100 mm	1089230-02
	Mounting frame	Mounting frame for mounting of the QUADRA-CHEK 3000 and POSITIP 8000 subsequent electronics in a panel	1089208-02
	Multi-Pos holder	Holder for fastening the device on an arm, continuously tiltable within an angle of 90°, fixing hole pattern 100 mm x 100 mm	1089230-04
	Multi-Pos stand	Stand for continuously variable tilting within an angle of 90°, fixing hole pattern 100 mm x 100 mm	1089230-03

Accessories	Name	Description	ID
	Single-Pos stand	Stand for rigid mounting, inclination angle 20°, fixing hole pattern 100 mm x 100 mm	1089230-01
For operation			
	POSITIP 8000 AEI1 software option	Enabling of an additional encoder input	1089228-02
	POSITIP 8000 AEI1 Trial software option	Enabling of an additional encoder input; trial version for a limited time (60 days)	1089228-52
	POSITIP 8000 NC1 software option	Feedback control of one axis (servo motor or stepper motor) of the machine tool	1089228-03
	POSITIP 8000 NC1 Trial software option	Feedback control of one axis (servo motor or stepper motor) of the machine tool; trial version for a limited time (60 days)	1089228-53

1.4 In case of damage in transit

- ▶ Have the shipping agent confirm the damage
- ▶ Keep the packaging materials for inspection
- ▶ Notify the sender of the damage
- ▶ Contact the distributor or machine manufacturer for replacement parts



If damage occurred during transit:

- ▶ Keep the packaging materials for inspection
- ▶ Contact HEIDENHAIN or the machine manufacturer

This applies also if damage occurred to requested replacement parts during transit.

1.5 Repackaging and storage

Repackage and store the product carefully in accordance with the conditions stated below.

1.5.1 Repackaging the product

Repackaging should correspond to the original packaging as closely as possible.

- ▶ Re-attach all mounting parts and dust protection caps to the product as received from the factory, or repackage them in the original packaging as received from the factory
- ▶ Repackage the product in such a way that
 - it is protected from impact and vibration during transit
 - it is protected from the ingress of dust or humidity
- ▶ Place all accessories that were included in the shipment in the original packaging
Further information: "Items supplied and accessories", Page 61
- ▶ Enclose all the documentation that was included in the original packaging
Further information: "Storage and distribution of the documentation", Page 12



If the product is returned for repair to the Service department:

- ▶ Ship the product without accessories, without encoders and without peripherals

1.5.2 Storage of the product

- ▶ Package the product as described above
- ▶ Observe the specified ambient conditions
Further information: "Specifications", Page 213
- ▶ Inspect the product for damage after any transport or longer storage times

2

Mounting

2.1 Overview

This chapter describes the mounting of the product. It contains instructions about how to correctly mount the product on stands or holders.

i The following steps must be performed only by qualified personnel.
Further information: "Personnel qualification", Page 16

2.2 Assembly of the product

General mounting information

The mount for the mounting variants is provided on the rear panel. The connection is compatible with the VESA standard 100 mm x 100 mm.

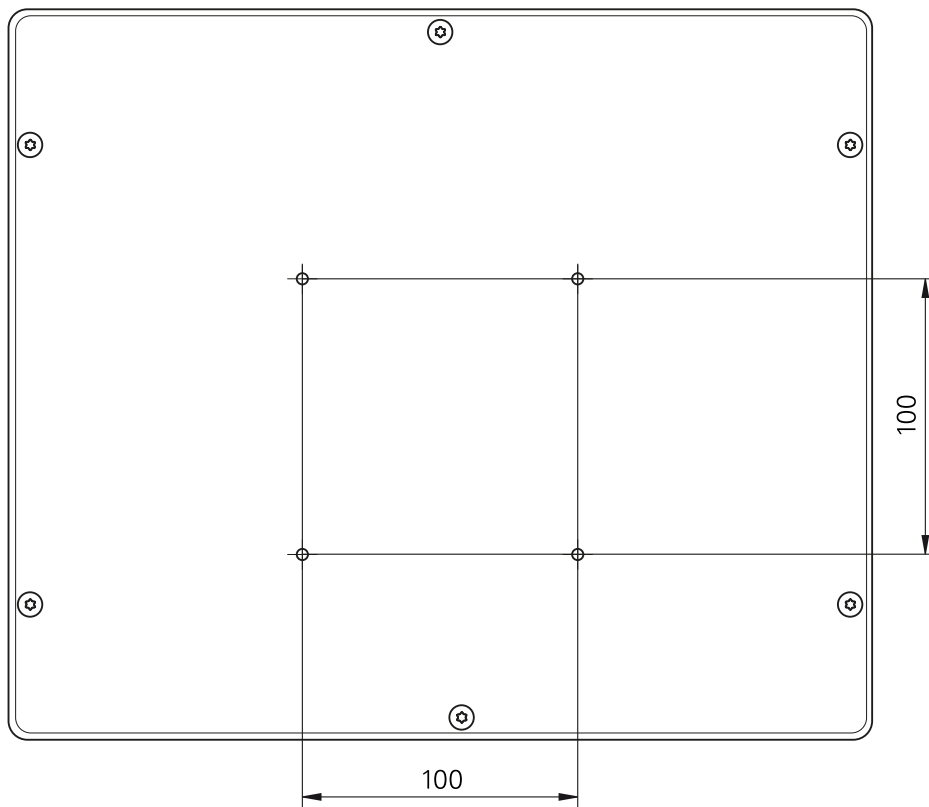

Figure 12: Dimensions of the rear panel

The materials for attachment of the mounting variants on the device are included in delivery.

You will also need the following:

- Torx T20 screwdriver
- Torx T25 screwdriver
- Allen key, size 2.5 (Duo-Pos stand)
- Materials for mounting on a supporting surface

i The unit must be mounted to a stand or a holder to ensure the correct and intended use of the product.

2.2.1 Mounting on Single-Pos stand

You can fasten the Single-Pos stand to the product at a 20° angle.

- ▶ Use the provided M4 x 8 ISO 14581 countersunk head screws to fasten the stand to the upper VESA 100 threaded holes on the rear panel



Comply with the permissible tightening torque of 2.6 Nm

- ▶ Fasten the stand with two suitable screws from above to a supporting surface or
- ▶ Attach self-adhesive rubber pads to the underside of the stand
- ▶ Route the cables from behind through the opening in the stand and then to the connections

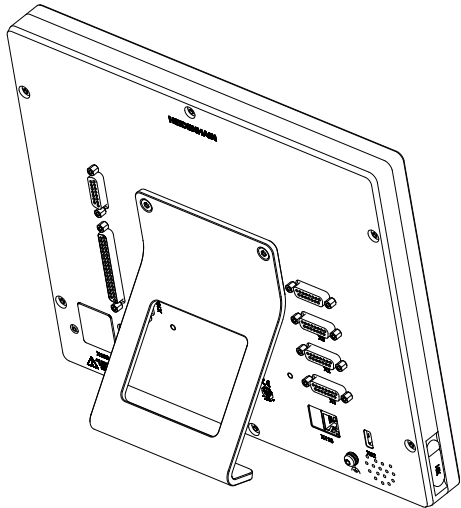

Figure 13: Product mounted on Single-Pos stand

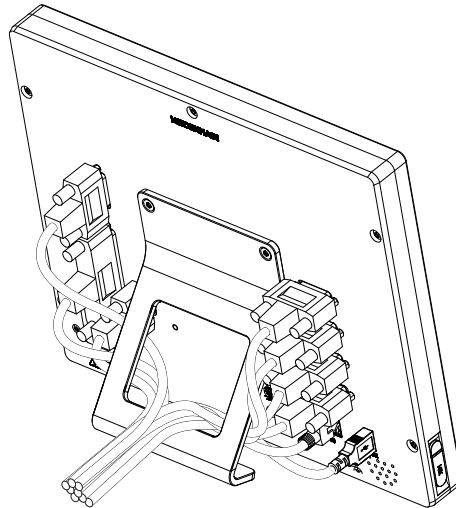

Figure 14: Cable routing on Single-Pos stand

Further information: "Product dimensions with Single-Pos stand", Page 218

2.2.2 Mounting on Duo-Pos stand

You can fasten the Duo-Pos stand to the product at a 20° or 45° angle.

- ▶ Use the provided M4 x 8 ISO 7380 hexagon socket screws to fasten the stand to the lower VESA 100 threaded holes on the rear panel



Comply with the permissible tightening torque of 2.6 Nm

- ▶ Using the mounting slots (width = 4.5 mm), screw the stand to a supporting surface
or
- ▶ Set up the device freely at the desired location
- ▶ Route the cable from behind through the two supports of the stand and then through the lateral openings to the connections

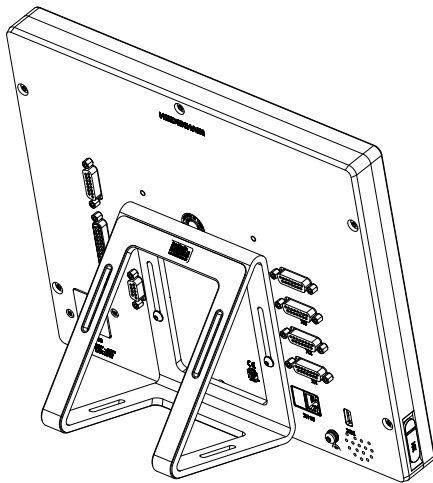

Figure 15: Product mounted on Duo-Pos stand

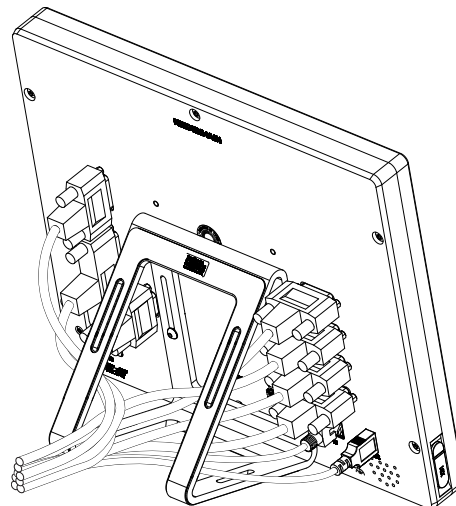

Figure 16: Cable routing on Duo-Pos stand

Further information: "Product dimensions with Duo-Pos stand", Page 218

2.2.3 Mounting on Multi-Pos stand

- ▶ Use the provided M4 x 8 ISO 14581 countersunk head screws (black) to fasten the stand to the VESA 100 threaded holes on the rear panel

i Comply with the permissible tightening torque of 2.6 Nm

- ▶ Using two M5 screws, you can also optionally screw the stand to a supporting surface from the bottom
- ▶ Adjust the desired angle of inclination within the tilting range of 90°
- ▶ To fix the stand: Tighten the T25 screw

i Comply with the tightening torque for screw T25

- Recommended tightening torque: 5.0 Nm
- Maximum permissible tightening torque: 15.0 Nm

- ▶ Route the cable from behind through the two supports of the stand and then through the lateral openings to the connections

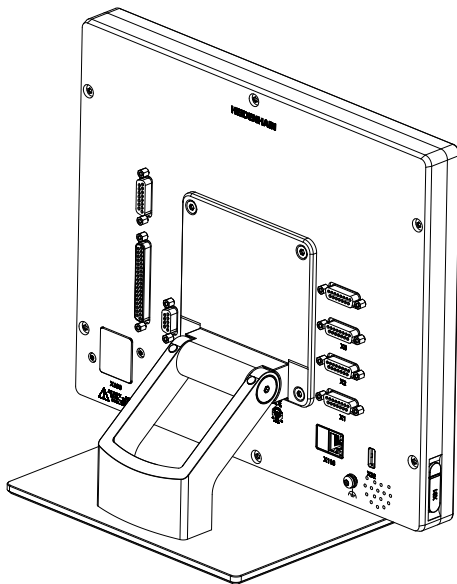

Figure 17: Product mounted on Multi-Pos stand

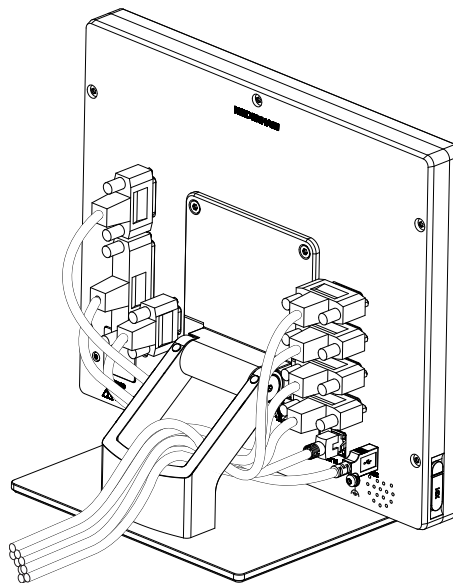

Figure 18: Cable routing on Multi-Pos stand

Further information: "Product dimensions with Multi-Pos stand", Page 219

2.2.4 Mounting on Multi-Pos holder

- ▶ Use the provided M4 x 8 ISO 14581 countersunk head screws (black) to fasten the holder to the VESA 100 threaded holes on the rear panel



Comply with the permissible tightening torque of 2.6 Nm

- ▶ Mount the holder with the supplied M8 screw, the washers, the handle and the M8 hexagon nut to an arm
- or
- ▶ Mount the holder with two screws <7 mm through the two holes to the intended surface
- ▶ Adjust the desired angle of inclination within the tilting range of 90°
- ▶ To fix the holder in place: tighten the T25 screw



Comply with the tightening torque for screw T25

- Recommended tightening torque: 5.0 Nm
- Maximum permissible tightening torque: 15.0 Nm

- ▶ Route the cable from behind through the two supports of the holder and then through the lateral openings to the connections

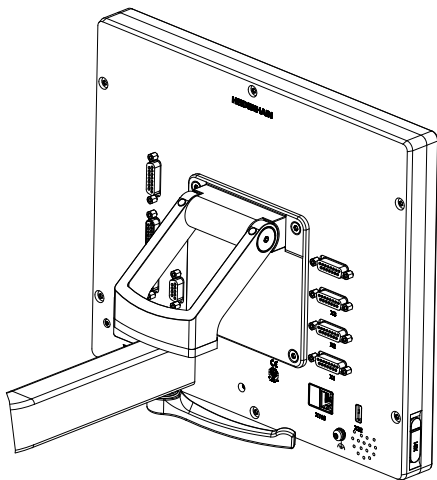

Figure 19: Product mounted on Multi-Pos holder

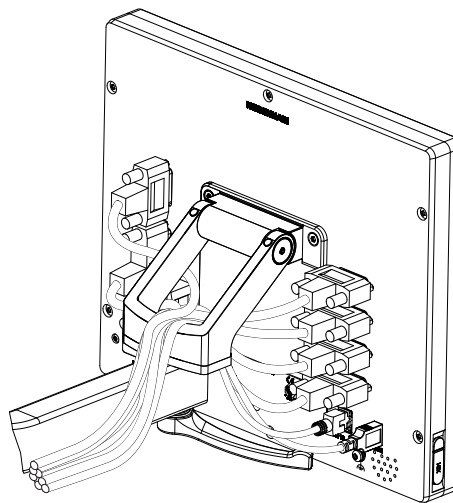

Figure 20: Cable routing on Multi-Pos holder

Further information: "Product dimensions with Multi-Pos holder", Page 219

3

Installation

3.1 Overview

This chapter describes the Installation of the product. It contains information about the product's connections and instructions about how to correctly connect the peripheral devices.



The following steps must be performed only by qualified personnel.

Further information: "Personnel qualification", Page 16

3.2 General information

NOTICE

Interference from sources of high electromagnetic emission!

Peripheral devices, such as frequency inverters or servo drives, may cause interference.

To increase the noise immunity to electromagnetic influences:

- ▶ Use the optional functional ground connection as per IEC/EN 60204-1
- ▶ Use only USB peripherals with continuous shielding, e.g. by metalized film and metal braiding or a metal housing. The degree of coverage provided by the braiding must be 85 % or higher. The shield must be connected around the entire circumference of the connectors (360° connection).

NOTICE

Damage to the device from the engaging and disengaging of connecting elements during operation!

Damage to internal components may result.

- ▶ Do not engage or disengage any connecting elements while the unit is under power

NOTICE

Electrostatic discharge (ESD)!

This device contains electrostatic-sensitive components that can be destroyed by electrostatic discharge (ESD).

- ▶ It is essential to observe the safety precautions for handling ESD-sensitive components
- ▶ Never touch connector pins without ensuring proper grounding
- ▶ Wear a grounded ESD wristband when handling device connections

NOTICE**Damage to the product due to incorrect wiring!**

The incorrect wiring of inputs or outputs can cause damage to the product or to peripheral devices.

- ▶ Comply with the pin layouts and specifications of the product
- ▶ Assign only pins or wires that will be used

Further information: "Specifications", Page 213

3.3 Device overview

The connections on the rear panel of the device are protected by dust protection caps from contamination and damage.

NOTICE**Contamination or damage may result if the dust protection caps are missing!**

If no dust protection caps are fitted to unused connections, this may impair the proper functioning of the contacts or destroy them.

- ▶ Remove dust protection caps only when connecting measuring devices or peripherals
- ▶ If you remove a measuring device or peripheral, re-attach the dust protection cap to the connection



The type of connections for encoders may vary depending on the product version.

Rear panel without dust protection caps

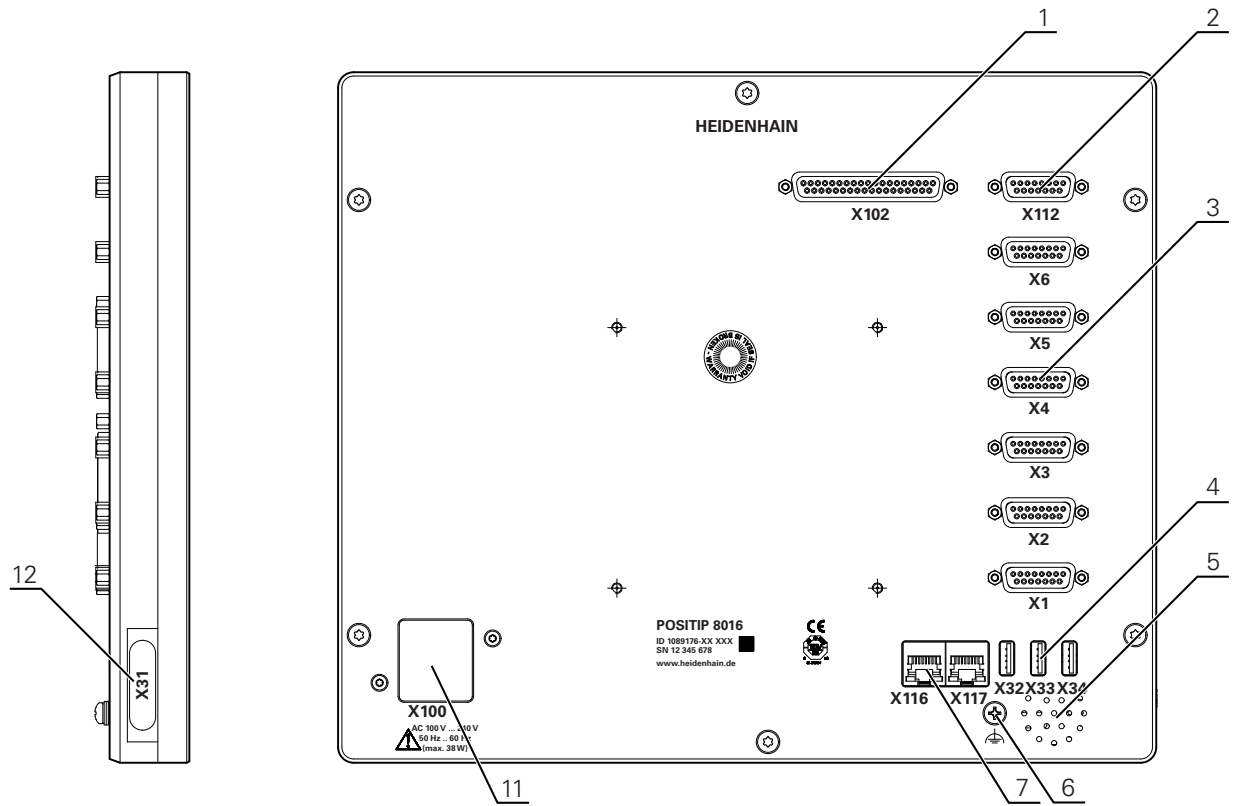

Figure 21: Rear panel of devices with ID 1089176-xx

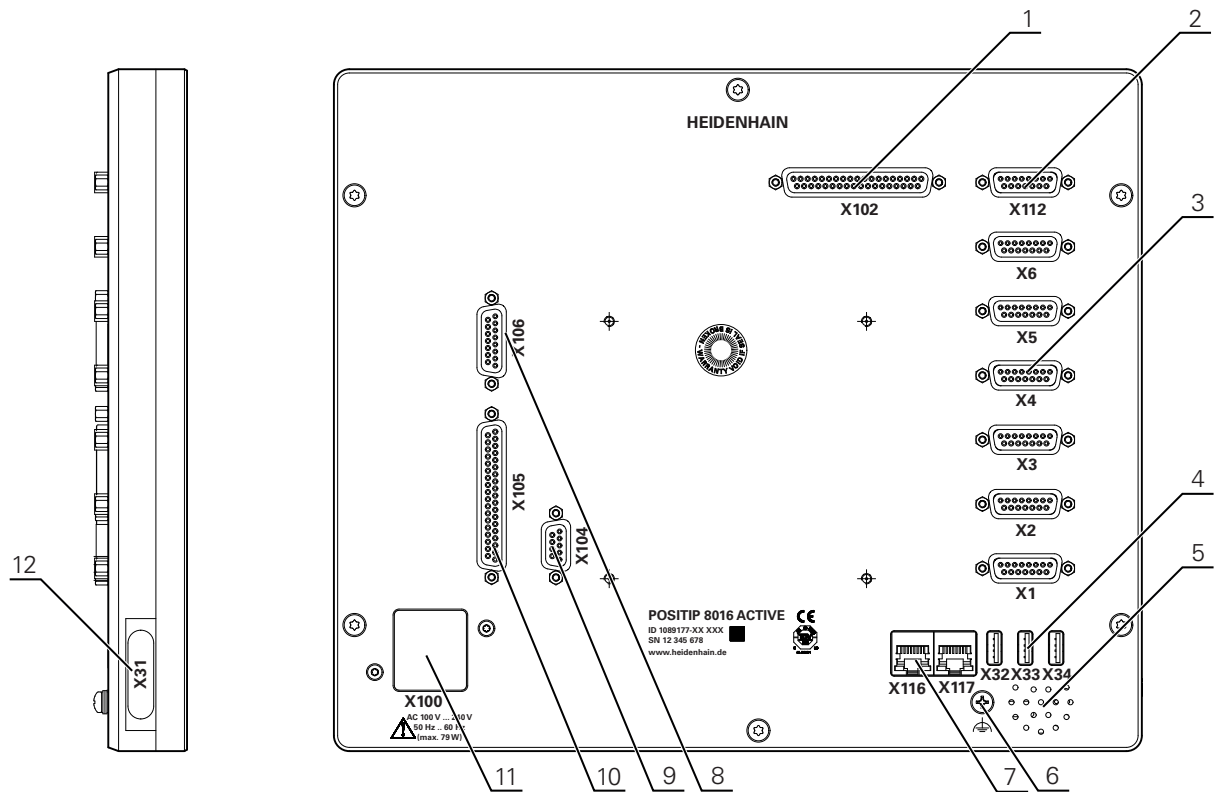

Figure 22: Rear panel of devices with ID 1089177-xx

Connections

- 1 **X102**: 37-pin D-sub connection for digital TTL interface (8 inputs, 16 outputs)
- 2 **X112**: 15-pin D-sub connection for touch probes (e.g. HEIDENHAIN touch probe)
- 3 **X1-X6**: 15-pin D-sub connections for encoder with interfaces of the type 1 V_{PP}, 11 μA_{PP} or EnDat 2.2
Four inputs enabled by default, with option of enabling another two inputs
- 4 **X32-X34**: USB 2.0 Hi-Speed connection (Type-A) for USB mass storage device
- 5 Speaker
- 6 Functional ground connection as per IEC/EN 60204-1
- 7 **X116**: RJ45 Ethernet connection for communication and data exchange with downstream systems or PC
X117: Not currently supported
- 11 **X100**: Power switch and power connection

Additional connections on devices with ID 1089177-xx:

- 8 **X106**: 15-pin D-sub connection for analog interface (4 inputs, 4 outputs)
- 9 **X104**: 9-pin D-sub connection for universal relay interface (2x relay changeover contacts)
- 10 **X105**: 37-pin D-sub connection for digital interface (DC 24 V; 24 switching inputs, 8 switching outputs)

Left side panel

- 12 **X31** (under protective cover): USB 2.0 Hi-Speed connection (Type-A) for USB mass storage device

3.4 Connecting encoders

i For encoders with an EnDat 2.2 interface: If the corresponding encoder input has already been assigned to an axis in the device settings, then the encoder is automatically detected upon restart, and the settings are adapted. Alternatively, you can assign the encoder input after you have connected the encoder.

- ▶ Comply with the pin layout
- ▶ Remove and save the dust protection cap
- ▶ Route the cables depending on the mounting variant
Further information: "Assembly of the product", Page 66
- ▶ Connect the encoder cables tightly to the respective connections
Further information: "Device overview", Page 73
- ▶ If the cable connectors include mounting screws, do not overtighten them

Pin layout of X1, X2, X3, X4, X5, X6

1 V _{PP} , 11 μA _{PP} , EnDat 2.2								
	1	2	3	4	5	6	7	8
1 V _{PP}	A+	0 V	B+	U _P	/	/	R-	/
11 μA _{PP}	I ₁₊		I ₂₊		/	Internal shield	I ₀₊	/
EnDat	/		/		DATA		/	CLOCK
	9	10	11	12	13	14	15	
1 V _{PP}	A-	Sense 0 V	B-	Sense U _P	/	R+	/	
11 μA _{PP}	I ₁₋		I ₂₋		/	I ₀₊	/	
EnDat	/		/		DATA	/	CLOCK	

3.5 Wiring switching inputs and outputs

⚠ WARNING

Hazard when using switching inputs for safety functions!

If switching inputs for mechanical limit switches are used for safety functions, severe injury or death can result.

- ▶ Do not use the switching inputs for mechanical limit switches for safety functions

i Depending on the peripherals to be connected, the connection work may need to be carried out by an electrical specialist.
 Example: Safety Extra Low Voltage (SELV) exceeded
Further information: "Personnel qualification", Page 16

i The device fulfills the requirements of standard IEC 61010-1 if power is supplied from a secondary circuit with current limitation as per IEC 61010-13rd Ed., Section 9.4, or from a Class 2 secondary circuit as specified in UL1310.
 In place of IEC 61010-13rd Ed. Section 9.4, the corresponding sections of the standards DIN EN 61010-1, EN 61010-1, UL 61010-1 and CAN/CSA-C22.2 No. 61010-1 can be used as well.

- ▶ Wire switching inputs and outputs in accordance with the following pin layout
 - ▶ Remove and save the dust protection cap
 - ▶ Route the cables depending on the mounting variant
- Further information:** "Assembly of the product", Page 66

- ▶ Connect the connecting cables of the peripherals tightly to their connectors
- ▶ **Further information:** "Device overview", Page 73
- ▶ If the cable connectors include mounting screws, do not overtighten them

i The digital or analog inputs and outputs must be assigned in the device settings of the respective switching function.

Pin layout of X102

1	2	3	4	5	6	7	8
GND	Din 1	Din 3	Din 4	Din 6	GND	Dout 0	Dout 2
9	10	11	12	13	14	15	16
Dout 4	GND	Dout 6	Dout 8	Dout 10	GND	Dout 12	Dout 14
17	18	19	20	21	22	23	24
/	/	GND	Din 0	Din 2	DC 5 V	Din 5	Din 7
25	26	27	28	29	30	31	32
GND	Dout 1	Dout 3	Dout 5	GND	Dout 7	Dout 9	Dout 11
33	34	35	36	37			
GND	Dout 13	Dout 15	/	/			

Digital inputs:

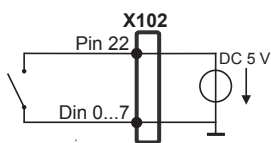

Digital outputs:

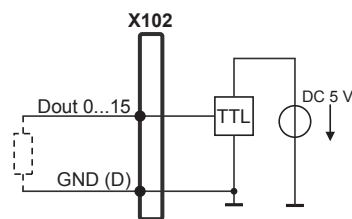

Pin layout of X104

1	2	3	4	5	6	7	8	9
R-0 NO	R-0 NC	/	R-1 NO	R-1 NC	R-0 CO	/	/	R-1 CO

CO – Change Over
 NO – Normally Open
 NC – Normally Closed

Relay outputs:

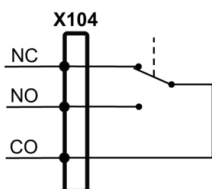

Pin layout of X105

1	2	3	4	5	6	7	8
Din 0	Din 2	Din 4	Din 6	Din 8	Din 10	Din 12	Din 14
9	10	11	12	13	14	15	16
Din 16	Din 18	Din 20	Din 22	Dout 0	Dout 2	Dout 4	Dout 6
17	18	19	20	21	22	23	24
DC 24 V	DC 24 V	GND	Din 1	Din 3	Din 5	Din 7	Din 9
25	26	27	28	29	30	31	32
Din 11	Din 13	Din 15	Din 17	Din 19	Din 21	Din 23	Dout 1
33	34	35	36	37			
Dout 3	Dout 5	Dout 7	DC 24 V	GND			

Digital inputs:

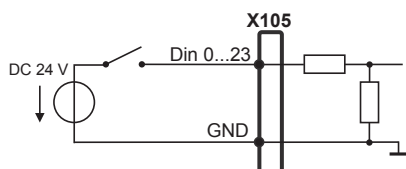

Digital outputs:

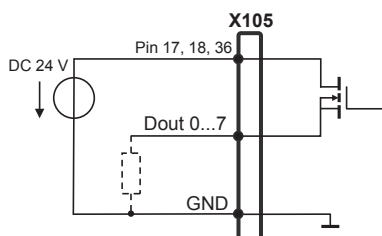

Pin layout of X106

1	2	3	4	5	6	7	8
Aout 0+	Aout 1+	Aout 2+	Aout 3+	GND	GND	Ain 1	Ain 3
9	10	11	12	13	14	15	
Aout 0-	Aout 1-	Aout 2-	Aout 3-	DC 5 V	Ain 0	Ain 2	

Analog inputs:

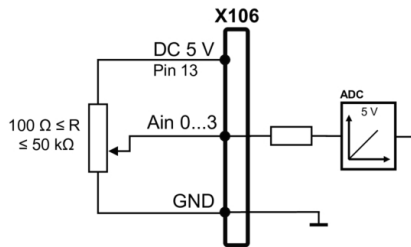

Analog outputs:

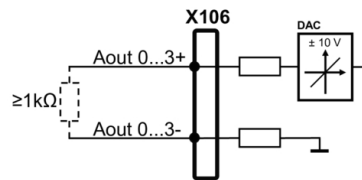

3.6 Connecting input devices

- ▶ Comply with the pin layout
- ▶ Remove and save the dust protection cap
- ▶ Route the cables based on the mounting variant
- Further information:** "Assembly of the product", Page 66
- ▶ Connect USB mouse or USB keyboard to USB Type-A port (X31, X32, X33, X34). Make sure the USB cable connector is fully inserted
- Further information:** "Device overview", Page 73

Pin layout of X31, X32, X33, X34

1	2	3	4
DC 5 V	Data (-)	Data (+)	GND

3.7 Connecting a network peripheral

- ▶ Comply with the pin layout
- ▶ Remove and save the dust protection cap
- ▶ Route the cables depending on the mounting variant
- Further information:** "Assembly of the product", Page 66
- ▶ Connect the network peripheral to Ethernet port X116 using a standard CAT.5 cable. The cable connector must firmly engage in the port
- Further information:** "Device overview", Page 73

Pin layout of X116

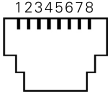
							
1	2	3	4	5	6	7	8
D1+ (TX+)	D1- (TX-)	D2+ (RX+)	D3+	D3-	D2- (RX-)	D4+	D4-

3.8 Connecting the line voltage

⚠ WARNING

Risk of electric shock!

Improper grounding of electrical devices may result in serious personal injury or death by electric shock.

- ▶ Always use 3-wire power cables
- ▶ Make sure the ground wire is correctly connected to the ground of the building's electrical installations

⚠ WARNING

Fire hazard due to wrong power cable!

Use of a power cable that does not meet the requirements of the mounting location may cause a fire hazard.

- ▶ Use only a power cable that meets at least the national requirements of the respective country in which the product is mounted

- ▶ Comply with the pin layout
- ▶ Connect the power connection to a 3-wire grounded power outlet using a power cable that meets requirements

Further information: "Device overview", Page 73

Pin layout X100

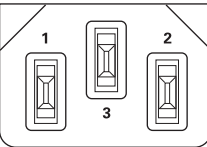
		
1	2	3
L/N	N/L	⊕

4

Commissioning

4.1 Overview

This chapter contains all the information necessary for commissioning the product.

During commissioning, the machine manufacturer's commissioning engineer (**OEM**) configures the product for use on the specific machine tool.

The settings can be reset to the factory defaults.

Further information: "Reset all settings", Page 210

 Make sure that you have read and understood the "Basic Operation" chapter before carrying out the actions described below.

Further information: "Basic Operation", Page 19

 The following steps must be performed only by qualified personnel.

Further information: "Personnel qualification", Page 16

4.2 Logging in for commissioning

4.2.1 User login

To commission the product, the **OEM** user must log in.



- ▶ Tap **User login** in the main menu
- ▶ If required, log out the user who is currently logged in
- ▶ Select the **OEM** user
- ▶ Tap the **Password** input field
- ▶ Enter the password "**oem**"

 If a password other than the default password has been assigned to the user, ask a **Setup** or **OEM** user for the assigned password.

If the password is no longer known, contact a HEIDENHAIN service agency.



- ▶ Confirm the entry with **RET**
- ▶ Tap **Log in**
- > The user is logged in.
- > The product opens the the **Manual operation** mode.

4.2.2 Performing the reference mark search after startup

 If the product is configured with a **spindle axis S**, then you must define an upper limit for the spindle speed prior to a possible machining operation.
Further information: "Defining the upper limit for the spindle speed", Page 227

 If the reference mark search after unit start is active, then all of the unit's functions will be disabled until the reference mark search has been successfully completed.
Further information: "Reference marks (Encoder)", Page 97

 For encoders with EnDat interface, the reference mark search is omitted because the axes are referenced automatically.

If the reference mark search is active on the unit, then a wizard will ask you to traverse the reference marks of the axes.

- ▶ After logging in, follow the instructions of the wizard
- > The Reference symbol stops blinking upon successful completion of the reference mark search.

Further information: "Operating elements of the position display", Page 40

Further information: "Activating the reference mark search", Page 140

4.2.3 Setting the language

The user interface language is English. You can change to another language, if desired.



- ▶ Tap **Settings** in the main menu



- ▶ Tap **User**
- > The logged-in user is indicated by a check mark.
- ▶ Select the logged-in user
- > The language selected for the user is indicated by a national flag in the **Language** drop-down list.
- ▶ Select the flag for the desired language from the **Language** drop-down list
- > The user interface is displayed in the selected language.

4.2.4 Changing the password

You must change the password to prevent unauthorized configuration.

The password is confidential and must not be disclosed to any other person.



- ▶ Tap **Settings** in the main menu



- ▶ Tap **User**
 - > The logged-in user is indicated by a check mark.
 - ▶ Select the logged-in user
 - ▶ Tap **Password**
 - ▶ Enter the current password
 - ▶ Confirm entry with **RET**
 - ▶ Enter the new password and repeat it
 - ▶ Confirm entry with **RET**
 - ▶ Tap **OK**
 - ▶ Close the message with **OK**
 - > The new password is available the next time the user logs in.

4.3 Steps for commissioning



The following commissioning steps build on each other.

- ▶ To correctly commission the product, make sure to perform the steps in the order described here

Prerequisite: You are logged on as a user of the **OEM** type (see "Logging in for commissioning", Page 82).

Selecting the application

- Selecting the Application

Basic settings

- Activating Software options
- Setting the date and time
- Setting the units of measure

Configuring the axes

For EnDat interfaces:

- Configuring axes for encoders with EnDat interface
- Performing error compensation
- Ascertaining the line count per revolution

For 1 V_{PP} or 11 μA_{PP} interfaces:

- Activating the reference mark search
 - Configuring the axes for encoders with a 1 V_{PP} or 11 μA_{PP} interface
 - Performing error compensation
 - Ascertaining the line count per revolution
-

- Configuring the central drive
 - Configuring specific settings for Axis + NC
 - Configuring the spindle axis
 - Configuring an Electronic handwheel
 - Coupling axes
 - Diameter axis
-

Configuring thread cutting

- Configuring thread cutting (NC software option)
-

Configuring M functions

- Standard M functions
 - Manufacturer-specific M functions
-

OEM area

- Adding documentation
 - Adding a startup screen
 - Configuring the OEM bar
 - Adjusting the display
 - Defining error messages
 - Backing up and restoring OEM settings
 - Configuring the unit for screenshots
-

Backing up data

- Back up settings
 - Back up user files
-

NOTICE

Loss of or damage to configuration data!

If the product is disconnected from the power source while it is on, the configuration data can be lost or corrupted.

- ▶ Back up the configuration data and keep the backup for recovery purposes

4.4 Selecting the Application

When putting the product into service, you can choose between the standard application modes of **Milling** and **Turning**.

In its factory default setting, the product is already set to the **Milling** application mode.

 When you change the unit's application mode, then all of the axis settings will be reset.

Settings ▶ Service ▶ OEM area ▶ Settings

Parameter	Explanation
Application	<p>The type of application mode; a change becomes active after a restart</p> <p>Settings:</p> <ul style="list-style-type: none"> ■ Milling ■ Turning <p>Default value: Milling</p>

4.5 Basic settings

4.5.1 Activating Software options

You can activate additional **Software options** via a **License key**.

 You can view the enabled **Software options** on the overview page.
Further information: "Checking the Software options", Page 88

Requesting license key

You can request a license key by using the following procedure:

- Reading out device information for the license key request
- Creating a license key request

Reading out device information for the license key request



- ▶ Tap **Settings** in the main menu



- ▶ Tap **General**
- ▶ Tap **Device information**
- > An overview of the device information is opened.
- > The product designation, ID number, serial number, and firmware version are displayed.
- ▶ Contact a HEIDENHAIN service agency and submit the displayed device information in order to request a license key for the product
- > The license key and the license file are generated and submitted by e-mail

Creating a license key request



- ▶ Tap **Settings** in the main menu



- ▶ Tap **Service**
- ▶ Tap **Software options**
- ▶ To request a software option that is available for a fee, tap **Request options**
- ▶ To request a free trial option, tap **Request trial options**
- ▶ To select the desired software option, tap its check mark or use **+** and **-** to select the number of options



- ▶ To deselect an entry, tap the check mark for the respective software option

- ▶ Tap **Creating a request**
- ▶ In the dialog box, select the storage location in which you want to save the license key request
- ▶ Enter a suitable file name
- ▶ Confirm your input with **RET**
- ▶ Tap **Save as**
- The license key request is created and saved in the selected folder.
- ▶ If the license key request is stored on the product, move the file to a connected USB mass storage device (FAT32 format) or the network drive
 - Further information:** "Managing folders and files", Page 175
- ▶ Safely remove USB stick
- ▶ Contact a HEIDENHAIN service agency and submit the file you created in order to request a license key
- The license key and the license file are generated and submitted by e-mail

Activating a license key

You can activate a license key by

- Reading the license key from the provided license file into the product
- Entering the license key manually into the product

Uploading license key from license file



- ▶ Tap **Settings** in the main menu



- ▶ Tap **Service**
- ▶ Open in succession:
 - **Software options**
 - **Activate options**
- ▶ Tap **Read license file**
- ▶ Select the license file in the file system, on the USB mass storage device or on the network drive
- ▶ Confirm your selection with **Select**
- ▶ Tap **OK**
- > The license key is activated.
- ▶ Tap **OK**
- > You may need to restart the product, depending on the software option.
- ▶ Confirm the restart with **OK**
- > The activated software option is available.

Entering license key manually



- ▶ Tap **Settings** in the main menu



- ▶ Tap **Service**
- ▶ Open in succession:
 - **Software options**
 - **Activate options**
- ▶ Enter the license key into the **License key** input field
- ▶ Confirm the entry with **RET**
- ▶ Tap **OK**
- > The license key is activated.
- ▶ Tap **OK**
- > You may need to restart the product, depending on the software option.
- ▶ Confirm the restart with **OK**
- > The activated software option is available.

Checking the Software options

On the overview page, you can check which **Software options** are enabled for the product.



- ▶ Tap **Settings** in the main menu



- ▶ Tap **Service**
- ▶ Open in succession:
 - **Software options**
 - **Overview**
- > A list of enabled **Software options** is displayed.

4.5.2 Setting the date and time

Settings ► General ► Date and time

Parameter	Explanation
Date and time	Current date and time of the product <ul style="list-style-type: none"> Settings: Year, Month, Day, Hour, Minute Default setting: Current system time
Date format	Format in which the date is displayed Settings: <ul style="list-style-type: none"> MM-DD-YYYY: Month, day, year DD-MM-YYYY: Day, month, year YYYY-MM-DD: Year, month, day Default setting: YYYY-MM-DD (e.g. "2016-01-31")

4.5.3 Setting the units of measure

You can set various parameters to define the units of measure, rounding methods and decimal places.

Settings ► General ► Units

Parameter	Explanation
Unit for linear values	Unit of measure for linear values <ul style="list-style-type: none"> Settings: Millimeters or Inch Default setting: Millimeters
Rounding method for linear values	Rounding method for linear values Settings: <ul style="list-style-type: none"> Commercial: Decimal places from 1 to 4 are rounded down, decimal places from 5 to 9 are rounded up Round off: Decimal places from 1 to 9 are rounded down Round up: Decimal places from 1 to 9 are rounded up Truncate: Decimal places are truncated without rounding up or down Round to 0 and 5: Decimal places ≤ 24 or ≥ 75 are rounded to 0, decimal places ≥ 25 or ≤ 74 are rounded to 5 Default setting: Commercial
Decimal places for linear values	Number of decimal places for linear values Setting range: <ul style="list-style-type: none"> Millimeters: 0 ... 5 Inch: 0 ... 7 Default value: <ul style="list-style-type: none"> Millimeters: 4 Inch: 6
Unit for angular values	Unit for angular values Settings: <ul style="list-style-type: none"> Radian: Angles in radian (rad) Decimal degrees: Angles in degrees ($^{\circ}$) with decimal places Deg-Min-Sec: Angles in degrees ($^{\circ}$), minutes [$'$] and seconds [$''$] Default setting: Decimal degrees

Parameter	Explanation
Rounding method for angular values	<p>Rounding method for decimal angular values</p> <p>Settings:</p> <ul style="list-style-type: none"> ■ Commercial: Decimal places from 1 to 4 are rounded down, decimal places from 5 to 9 are rounded up ■ Round off: Decimal places from 1 to 9 are rounded down ■ Round up: Decimal places from 1 to 9 are rounded up ■ Truncate: Decimal places are truncated without rounding up or down ■ Round to 0 and 5: Decimal places ≤ 24 or ≥ 75 are rounded to 0, decimal places ≥ 25 or ≤ 74 are rounded to 5 ■ Default setting: Commercial
Decimal places for angular values	<p>Number of decimal places for angular values</p> <p>Setting range:</p> <ul style="list-style-type: none"> ■ Radian: 0 ... 7 ■ Decimal degrees: 0 ... 5 ■ Deg-Min-Sec: 0 ... 2 <p>Default value:</p> <ul style="list-style-type: none"> ■ Radian: 5 ■ Decimal degrees: 3 ■ Deg-Min-Sec: 0
Decimal separator	<p>Separator for the display of values</p> <ul style="list-style-type: none"> ■ Settings: Point or Comma ■ Default setting: Point

4.6 Configuring the axes

The procedure varies depending on the interface type of the connected encoder and on the type of axis:

- Encoders with EnDat interface:
The encoder applies the parameters automatically
Further information: "Configuring axes for encoders with EnDat interface", Page 93
- Encoders with 1 V_{pp} or 11 μA_{pp} interface:
The parameters must be configured manually
- Axis type **Spindle**, **Gear spindle** and **Spindle with orientation**
The inputs, outputs, and additional parameters must be configured manually
Further information: "Spindle axis S", Page 127
- Axis type **Axis + NC**, **Electronic handwheel** (software option): The inputs, outputs, and additional parameters must be configured manually
Further information: "Configuring specific settings for Axis + NC", Page 110
Further information: "Configuring an Electronic handwheel", Page 134

For the parameters of HEIDENHAIN encoders that are typically connected to the product, refer to the overview of typical encoders.

Further information: "Overview of typical encoders", Page 92

4.6.1 Fundamentals of axis configuration

i In order to use functions such as the execution of blocks, the configuration of the axes must comply with the requirements of the respective application.

Reference system on lathes

When machining a workpiece on a lathe, the coordinates entered for the principal axes X, Y and Z are referenced to the workpiece zero point. During turning the reference axis is the rotational axis of the spindle. This axis is the Z axis. The X axis moves in the direction of the radius or diameter. The Y axis is perpendicular to the X axis and Z axis and is used for machining operations outside the center of the workpiece. The position of the tool tip is clearly defined by its X and Z coordinates. The angles entered for the rotary axis (C axis) are referenced to the zero point of the C axis.

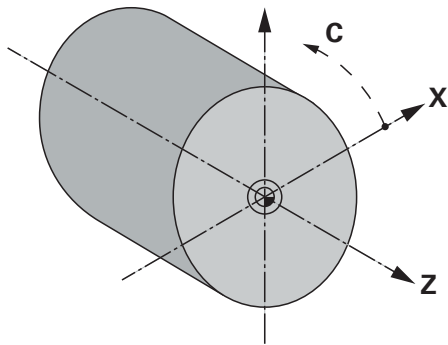

Figure 23: Assignment of the rectangular coordinate system to the workpiece

4.6.2 Overview of typical encoders

The following overview lists the parameters of the HEIDENHAIN encoders that are typically connected to the product.



When connecting other encoders, refer to the encoder's documentation for the required parameters.

Linear encoders

Examples of incremental encoders that are typically used

Encoder series	Interface	Signal period	Reference mark	Maximum traverse path
LS 383C	1 V _{PP}	20 μm	Coded	20 mm
LS 683C	1 V _{PP}	20 μm	Coded	20 mm
LS 187/487C	1 V _{PP}	20 μm	Coded	20 mm
LB 383C	1 V _{PP}	40 μm	Coded	80 mm

Examples of absolute encoders that are typically used

Encoder series	Interface	Measuring step
LC 415	EnDat 2.2	5 nm

Angle encoders and rotary encoders

Examples of incremental encoders that are typically used

Encoder series	Interface	Line count/ outputs signals per revolution	Reference mark	Nominal increment
RON 285C	1 V _{PP}	18000	Coded	20°
RON 886C	1 V _{PP}	18000	Coded	20°
ROD 280C	1 V _{PP}	18000	Coded	20°
ROD 480	1 V _{PP}	1000 ... 5000	One	-
ERN 180	1 V _{PP}	1000 ... 5000	One	-
ERN 480	1 V _{PP}	1000 ... 5000	One	-



The formulae below enable you to calculate the nominal increment of the distance-coded reference marks with angle encoders:

Nominal increment = $360^\circ \div \text{number of reference marks} \times 2$

Nominal increment = $(360^\circ \times \text{nominal increment in signal periods}) \div \text{line count}$

Examples of absolute encoders that are typically used

Encoder series	Interface	Measuring step
ROC 425	EnDat 2.2	25 bits
RCN 5310	EnDat 2.2	26 bits

4.6.3 Configuring axes for encoders with EnDat interface

If the corresponding encoder input has already been assigned to an axis, a connected encoder with EnDat interface is automatically detected upon restart, and the settings are adapted. Alternatively, you can assign the encoder input after you have connected the encoder.

Prerequisite: An encoder with EnDat interface is connected to the product.

Settings ► **Axes** ► **<Axis name>** ► **Encoder**

Parameter	Explanation
Encoder input	Assignment of the encoder input to the axis of the product Settings: <ul style="list-style-type: none"> ■ Not connected ■ X1 ■ X2 ■ X3 ■ X4 ■ X5 ■ X6 Further information: "Device overview", Page 73
Interface	Automatically detected EnDat interface type
ID label	Information on the encoder that was read from the electronic ID label
Diagnosis	Results of encoder diagnostics, evaluation of encoder function (e.g., based on functional reserves) Further information: "Diagnostics for encoders with EnDat interface", Page 204
Encoder model	Connected encoder model Settings: <ul style="list-style-type: none"> ■ Linear encoder: Linear axis ■ Angle encoder: Rotary axis ■ Angle encoder as linear encoder: Rotary axis is displayed as linear axis ■ Default value: Depending on the connected encoder
Mechanical ratio	For display of a rotary axis as a linear axis: traverse path in mm per revolution <ul style="list-style-type: none"> ■ Setting range: 0.1 mm ... 1000 mm ■ Default value: 1.0
Reference point displacement	Configuration of the offset between the reference mark and the zero point Further information: "Reference point displacement", Page 94

Using an Angle encoder as linear encoder

Certain parameters must be taken into account when configuring an angle encoder or rotary encoder as a linear encoder, in order to prevent an overrun of the system.

- The mechanical ratio must be chosen such that the maximum traverse range of 21474.483 mm is not exceeded
- The reference mark shift should only be used when considering the maximum traverse range of ± 21474.483 mm, since this limit applies both with and without a reference mark shift
- **Only for multiturn rotary encoders with EnDat 2.2:** the rotary encoder must be mounted such that an overrun of the rotary encoder does not affect the machine coordinates negatively

Reference point displacement

Settings ► Axes ► <Axis name> ► Encoder ► Reference marks ► Reference point displacement

Parameter	Explanation
Reference point displacement	Activation of offset calculation between reference mark and zero point of the machine <ul style="list-style-type: none"> ■ Setting range: ON or OFF ■ Default value: OFF
Reference point displacement	Manual input of the offset (in mm or degrees according to the selected encoder type) between reference mark and zero point Default value: 0.00000
Current position for reference point shift	Apply applies the current position as an offset (in mm or degrees, depending on the selected encoder model) between the reference mark and the zero point

4.6.4 Configuring the axes for encoders with a 1 V_{PP} or 11 μ A_{PP} interface

Settings ► Axes ► <Axis name> ► Encoder

Parameter	Explanation
Encoder input	Assignment of the encoder input to the axis of the product Settings: <ul style="list-style-type: none"> ■ Not connected ■ X1 ■ X2 ■ X3 ■ X4 ■ X5 ■ X6 Further information: "Device overview", Page 73
Incremental signal	Signal of the connected encoder Settings: <ul style="list-style-type: none"> ■ 1 V_{pp}: Sinusoidal voltage signal ■ 11 μA_{pp}: Sinusoidal current signal ■ Default value: 1 V_{pp}

Parameter	Explanation
Encoder model	<p>Connected encoder model</p> <p>Settings:</p> <ul style="list-style-type: none"> ■ Linear encoder: Linear axis ■ Angle encoder: Rotary axis ■ Angle encoder as linear encoder: Rotary axis is displayed as linear axis ■ Default value: Depending on the connected encoder
Signal period	<p>For linear encoders</p> <p>Length of a signal period</p> <ul style="list-style-type: none"> ■ Setting range: 0.001 μm ... 1000000.000 μm ■ Default value: 20.000
Line count	<p>For angle encoders and for display of a rotary axis as a linear axis.</p> <p>Number of lines</p> <ul style="list-style-type: none"> ■ Setting range: 1 ... 1000000 ■ Default value: 1000
Teach sequence	<p>Starts the teach sequence for determining the Line count for an angle encoder based on a specified angle of rotation.</p>
Display mode	<p>For angle encoders and for the display of a rotary axis as a linear axis.</p> <p>Settings:</p> <ul style="list-style-type: none"> ■ -∞ ... ∞ ■ 0° ... 360° ■ -180° ... 180° ■ Default value: -∞ ... ∞
Mechanical ratio	<p>For display of a rotary axis as a linear axis:</p> <p>traverse path in mm per revolution</p> <ul style="list-style-type: none"> ■ Setting range: 0.1 mm ... 1000 mm ■ Default value: 1.0
Reference marks	<p>Configuration of the Reference marks</p> <p>Further information: "Reference marks (Encoder)", Page 97</p>
Analog filter frequency	<p>Frequency value of the analog low-pass filter</p> <p>Settings:</p> <ul style="list-style-type: none"> ■ 33 kHz: Suppression of interference frequencies above 33 kHz ■ 400 kHz: Suppression of interference frequencies above 400 kHz ■ Default value: 400 kHz
Terminating resistor	<p>Dummy load to avoid reflections</p> <ul style="list-style-type: none"> ■ Settings: ON or OFF ■ Default value: ON
<div style="border: 1px solid black; padding: 5px; display: inline-block;">  The terminating resistor is automatically deactivated for incremental signals of the current signal type (11 μA_{PP}) </div>	

Parameter	Explanation
Error monitor	<p>Monitoring of signal errors</p> <p>Settings:</p> <ul style="list-style-type: none"> ■ Off: Error monitoring not active ■ Amplitude: Error monitoring of the signal amplitude ■ Frequency: Error monitoring of the signal frequency ■ Frequency & amplitude: Error monitoring of the signal amplitude and signal frequency ■ Default value: Frequency & amplitude <div style="border: 1px solid black; padding: 5px; margin-top: 10px;"> <p> A warning or error message is displayed if one of the limit values for error monitoring is exceeded.</p> </div> <p>The limit values depend on the signal of the connected encoder:</p> <ul style="list-style-type: none"> ■ Signal 1 Vpp, setting Amplitude <ul style="list-style-type: none"> ■ Warning with voltage ≤ 0.45 V ■ Error message with voltage ≤ 0.18 V or ≥ 1.34 V ■ Signal 1 Vpp, setting Frequency <ul style="list-style-type: none"> ■ Error message with frequency ≥ 400 kHz ■ Signal 11 μApp, setting Amplitude <ul style="list-style-type: none"> ■ Warning with current ≤ 5.76 μA ■ Error message with current ≤ 2.32 μA or ≥ 17.27 μA ■ Signal 11 μApp, setting Frequency <ul style="list-style-type: none"> ■ Error message with frequency ≥ 150 kHz
Counting direction	<p>Signal detection during axis movement</p> <p>Settings:</p> <ul style="list-style-type: none"> ■ Positive: The direction of traverse corresponds to the counting direction of the encoder ■ Negative: The direction of traverse does not correspond to the counting direction of the encoder ■ Default value: Positive
Diagnosis	<p>Results of encoder diagnostics, evaluation of encoder function (e.g., based on Lissajous figure)</p> <p>Further information: "Diagnostics for encoders with 1 V_{pp}/11 μA_{pp} interface", Page 203</p>

Ascertaining the line count per revolution

For angle encoders with interfaces of the type 1 V_{PP} or 11 μA_{PP} you can use a teach sequence to ascertain the exact line count per revolution.

Settings ▶ Axes ▶ <Axis name> ▶ Encoder

- ▶ From the **Encoder model** drop-down list, select **Angle encoder**
- ▶ For **Display mode**, select the option **-∞ ... ∞**
- ▶ Tap **Reference marks**
- ▶ Select one of the following options from the **Reference mark** drop-down list:
 - **None**: There is no reference mark
 - **One**: The encoder has one reference mark
- ▶ In order to switch to the previous axis, tap **Back**
- ▶ To start the teach sequence, tap **Start**
- ▶ The teach sequence is started and the Wizard opens.
- ▶ Follow the instructions of the wizard
- ▶ The line count determined during the teach sequence is transferred to the **Line count** field.



i The ascertained line count remains stored if you select a different display mode after the teach sequence.

Reference marks (Encoder)

Settings ▶ Axes ▶ <Axis name> ▶ Encoder ▶ Reference marks

i For encoders with EnDat interface, the reference mark search is omitted because the axes are referenced automatically.

Parameters	Explanation
Reference mark	Definition of the type of reference mark Settings: <ul style="list-style-type: none"> ■ None: There is no reference mark ■ One: The encoder has one reference mark ■ Coded: The encoder has distance-coded reference marks ■ Default value: One
Maximum traverse path	For linear encoders with coded reference marks: maximum traverse path for determining the absolute position <ul style="list-style-type: none"> ■ Setting range: 0.1 mm ... 10000.0 mm ■ Default value: 20.0
Nominal increment	For angle encoders with coded reference marks: maximum nominal increment for determining the absolute position <ul style="list-style-type: none"> ■ Setting range: > 0° ... 360° ■ Default value: 10.0

Parameters	Explanation
Inversion of reference mark pulses	Specifies whether the reference mark pulses are evaluated in inverted form Settings <ul style="list-style-type: none"> ■ ON: Reference pulses are evaluated in inverted form ■ OFF: Reference pulses are not evaluated in inverted form ■ Default value: OFF
Reference point displacement	Configuration of the offset between the reference mark and the zero point Further information: "Reference point displacement", Page 94

Reference point displacement

Settings ► Axes ► <Axis name> ► Encoder ► Reference marks ► Reference point displacement

Parameter	Explanation
Reference point displacement	Activation of offset calculation between reference mark and zero point of the machine <ul style="list-style-type: none"> ■ Setting range: ON or OFF ■ Default value: OFF
Reference point displacement	Manual input of the offset (in mm or degrees according to the selected encoder type) between reference mark and zero point Default value: 0.00000
Current position for reference point shift	Apply applies the current position as an offset (in mm or degrees, depending on the selected encoder model) between the reference mark and the zero point

4.6.5 Performing error compensation

Mechanical influences such as guideway errors, tilting in the end positions, tolerances of the mounting surface or poor mounting (Abbe error) may lead to measuring errors. Error compensation enables the device to automatically compensate for systematic measuring errors during machining of the workpieces. One or more compensation factors can be defined by comparing nominal and actual values.

A distinction is made between the following methods:

- Linear error compensation (LEC): The compensation factor is calculated based on the specified length of a calibration standard (nominal length) and the actual distance traversed (actual length). The compensation factor is applied linearly to the entire measuring range.
- Segmented linear error compensation (SLEC): The axis is divided into multiple segments with the help of a maximum of 200 supporting points. A distinct compensation factor is defined and applied for every segment.

NOTICE

Subsequent modifications to the encoder settings can result in measuring errors

If encoder settings such as the encoder input, encoder model, signal period, or reference marks are changed, previously determined compensation factors may no longer apply.

- ▶ If you change encoder settings, then you need to reconfigure the error compensation



For all methods, the actual error curve must be exactly measured (e.g., with the help of a comparator measuring device or calibration standard).



Linear error compensation and segmented linear error compensation cannot be combined with each other.



If you enable a reference point shift, then you need to reconfigure the error compensation. This helps you avoid measuring errors.

Configuring linear error compensation (LEC)

With linear error compensation (LEC), the product applies a compensation factor that is calculated from the specified length or angle of a reference standard (nominal length or nominal angle) and the actual traverse path (actual length and actual angle). The compensation factor is applied to the entire measuring range.

Settings ▶ Axes ▶ <Axis name> ▶ Error compensation ▶ Linear error compensation (LEC)

Parameter	Explanation
Compensation	<p>Mechanical influences on the axes of the machine are compensated</p> <p>Settings:</p> <ul style="list-style-type: none"> ■ ON: Compensation is active ■ OFF: Compensation is not active ■ Default value: OFF <div style="border: 1px solid black; padding: 5px; margin-top: 10px;"> <p>i If Compensation is active, the Nominal length and Actual length cannot be edited or generated.</p> </div>
Nominal length	<p>Input field for the length of the calibration standard according to the manufacturer's specifications</p> <p>Input: Millimeters or degrees (depending on the encoder)</p>
Actual length	<p>Input field for entering the measured length (actual distance traversed)</p> <p>Input: millimeters or degrees (depending on the encoder)</p>

i You can also use **Linear error compensation (LEC)** for angle encoders if the rotation angle is less than 360°.

Configuring segmented linear error compensation (SLEC)

For a segmented linear error compensation (SLEC), you divide the axis into short segments by defining up to 200 supporting points. The deviations between the actual distance traversed and the segment length in the individual segments determine the compensation values that compensate the mechanical influences acting on the axis.

i If the $-\infty \dots \infty$ display mode is selected for the angle encoder, the error compensation of angle encoders does not affect negative values of the supporting points.

**Settings ▶ Axes ▶ <Axis name> ▶ Error compensation ▶
Segmented linear error compensation (SLEC)**

Parameter	Explanation
Compensation	<p>Mechanical influences on the axes of the machine are compensated</p> <p>Settings:</p> <ul style="list-style-type: none"> ■ ON: Compensation is active ■ OFF: Compensation is not active ■ Default value: OFF
	<p>i When Compensation is active, then the Table of supporting points cannot be edited or created.</p>
Table of supporting points	<p>Opens the table of supporting points for manual editing</p> <p>The table shows the following for the respective segments:</p> <ul style="list-style-type: none"> ■ Supporting point positions (P) ■ Compensation values (D)
Create table of supporting points	<p>Opens the menu for creating a new Table of supporting points</p> <p>Further information: "Create table of supporting points", Page 102</p>

Create table of supporting points

**Settings ▶ Axes ▶ <Axis name> ▶ Error compensation ▶
Segmented linear error compensation (SLEC) ▶ Create table of supporting points**

Parameters	Explanation
Number of supporting points	Number of supporting points on the mechanical axis of the machine <ul style="list-style-type: none"> ■ Setting range: 2 ... 200 ■ Default value: 2
Spacing of the supporting points	Spacing of the supporting points on the mechanical axis of the machine <ul style="list-style-type: none"> ■ Default value: 100.00000
Start point	The start point defines the position starting from which the compensation is applied to the axis <ul style="list-style-type: none"> ■ Default value: 0.00000
Create	Creates a new table of supporting points based on the entries

- ▶ Enter the compensation value (D) "**0.0**" for supporting point **0**
- ▶ Enter the measured compensation values into the **compensation value (D)** input field for each supporting point created
- ▶ Confirm the entries with **RET**

Create table of supporting points

**Settings ▶ Axes ▶ <Axis name> ▶ Error compensation ▶
Segmented linear error compensation (SLEC) ▶ Create table of supporting points**

Parameters	Explanation
Number of supporting points	Number of supporting points on the mechanical axis of the machine <ul style="list-style-type: none"> ■ Setting range: 2 ... 200 ■ Default value: 2
Spacing of the supporting points	Spacing of the supporting points on the mechanical axis of the machine <ul style="list-style-type: none"> ■ Default value: 100.00000
Start point	The start point defines the position starting from which the compensation is applied to the axis <ul style="list-style-type: none"> ■ Default value: 0.00000
Create	Creates a new table of supporting points based on the entries

Adjusting an existing table of supporting points

After a table of supporting points for segmented linear error compensation has been created, this table can then be modified as needed.

**Settings ▶ Axes ▶ <Axis name> ▶ Error compensation ▶
Segmented linear error compensation (SLEC)**

- ▶ Use the **ON/OFF** slide switch to deactivate the **Compensation** function
- ▶ Tap **Table of supporting points**
- > The table lists the **supporting point positions (P)** and the **compensation values (D)** of the individual segments.
- ▶ Adjust the **compensation value (D)** for the supporting points
- ▶ Confirm the entries with **RET**
- ▶ To switch to the previous display, tap **Back**
- ▶ Activate **Compensation** with the **ON/OFF** slide switch
- > The adjusted error compensation for the axis is applied.



Further information: "Configuring segmented linear error compensation (SLEC)",
Page 101

4.6.6 Configuring the central drive

If your machine has a central drive, you first have to make some general motor settings. After this, you can assign the central drive to every axis that is to be moved by it and also make further settings for each individual axis.

The following flowchart shows the configuration procedure:

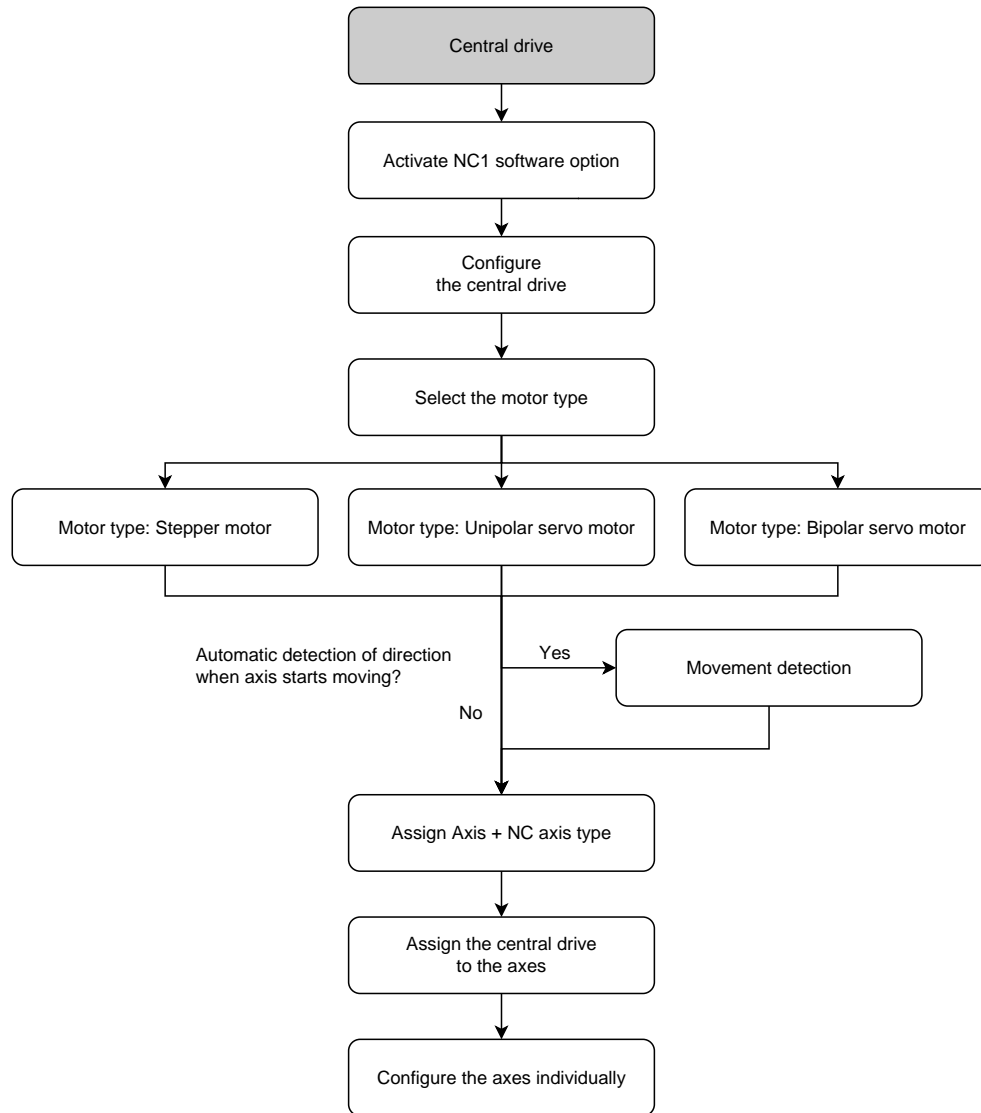

Central drive: Making general settings

In the general settings you can configure your central drive.

Settings ► Axes ► General settings ► Central drive

Parameter	Explanation
Central drive	If your machine uses a central drive, you can activate it here Settings: <ul style="list-style-type: none"> ■ ON: The central drive is activated and the configuration can be made ■ OFF: The central drive cannot be assigned to any axes ■ Default value: OFF

Type of motor	Selection of the motor type Settings: <ul style="list-style-type: none"> ■ Bipolar servo motor: -10 V ... 10 V ■ Unipolar servo motor: 0 V ... 10 V ■ Stepper motor
----------------------	--

Motor type: Bipolar servo motor

Parameter	Explanation
Analog output	Assignment of the analog output of the servo motor according to pin layout <ul style="list-style-type: none"> ■ Default value: Not connected
Umax	Maximum voltage that is output at the analog output in order to attain Fmax You can specify Fmax separately for each axis <ul style="list-style-type: none"> ■ Setting range: 1000 mV ... 10000 mV ■ Default value: 9000
Drive enable	Assignment of the digital output for the drive enable according to pin layout <ul style="list-style-type: none"> ■ Default value: Not connected
Input for error signal	Assignment of the digital input for fault signal detection The available signal leads to the drive being stopped with a corresponding error message <ul style="list-style-type: none"> ■ Default value: Not active
Signal is low-active	Select how the fault signal is to be identified
Electronic axis clamping for active axis	Select whether the axis is to be clamped when it is on the target position Settings: <ul style="list-style-type: none"> ■ ON: The axis is retained in closed-loop control ■ OFF: The axis is removed from closed-loop control ■ Default value: OFF
Target position reached	Assignment of the digital output when the axis is on the Target position in MDI mode or in program run <ul style="list-style-type: none"> ■ Default value: Not connected

Parameter	Explanation
Standstill monitoring for non-controlled axes	<p>Selection of whether standstill monitoring is to be used</p> <p>Settings:</p> <ul style="list-style-type: none"> ■ ON: Monitoring is activated; during active access of an axis to the central drive, all other axes that are configured as central-drive axis are monitored for standstill. If the position tolerance is exceeded, the central drive is switched off with a corresponding error message ■ OFF: Monitoring is deactivated; during access of an axis to the central drive, all other axes can be moved freely ■ Default value: OFF
Linear position tolerance for active standstill monitoring	<p>Starting from this threshold value, movement of a noncontrolled linear axis is assumed and the central drive is stopped with a corresponding error message</p> <ul style="list-style-type: none"> ■ Setting range: 0.005 mm ... 2.000 mm ■ Default value: 0.05 mm
Radial position tolerance for active standstill monitoring	<p>Starting from this threshold value, movement of a noncontrolled rotary axis is assumed and the central drive is stopped with a corresponding error message</p> <ul style="list-style-type: none"> ■ Setting range: 0.005 ° ... 45.000 ° ■ Default value: 0.5 °

Motor type: Unipolar servo motor

Parameter	Explanation
Analog output	Assignment of the analog output of the servo motor according to pin layout <ul style="list-style-type: none"> ■ Default value: Not connected
Umax	Maximum voltage that is output at the analog output in order to attain Fmax You can specify Fmax separately for each axis <ul style="list-style-type: none"> ■ Setting range: 1000 mV ... 10000 mV ■ Default value: 9000
Enable clockwise rotation	Assignment of the digital output for the clockwise spindle enable <ul style="list-style-type: none"> ■ Default value: Not connected
Enable counterclockwise rotation	Assignment of the digital output for the counterclockwise spindle enable <ul style="list-style-type: none"> ■ Default value: Not connected
Drive enable	Assignment of the digital output for the drive enable according to pin layout <ul style="list-style-type: none"> ■ Default value: Not connected
Input for error signal	Assignment of the digital input for fault signal detection <ul style="list-style-type: none"> ■ Default value: Not active
Signal is low-active	Select how the fault signal is to be identified
Electronic axis clamping for active axis	Select whether the axis is to be clamped when it is on the target position Settings: <ul style="list-style-type: none"> ■ ON: The axis is clamped ■ OFF: The axis is not clamped ■ Default value: OFF
Target position reached	Assignment of the digital output when the axis is on the Target position in MDI mode or in program run <ul style="list-style-type: none"> ■ Default value: Not connected
Standstill monitoring for non-controlled axes	Selection of whether standstill monitoring is to be used Settings: <ul style="list-style-type: none"> ■ ON: Monitoring is activated ■ OFF: Monitoring is deactivated ■ Default value: OFF
Linear position tolerance for active standstill monitoring	Starting from this threshold value, movement of a noncontrolled linear axis is assumed and the central drive is stopped with a corresponding error message <ul style="list-style-type: none"> ■ Setting range: 0.005 mm ... 2.000 mm ■ Default value: 0.05 mm
Radial position tolerance for active standstill monitoring	Starting from this threshold value, movement of a noncontrolled rotary axis is assumed and the central drive is stopped with a corresponding error message <ul style="list-style-type: none"> ■ Setting range: 0.005 ° ... 45.000 ° ■ Default value: 0.5 °

Motor type: Stepper motor

Parameter	Explanation
Output for stepper motor	Assignment of the stepper motor output according to pin layout <ul style="list-style-type: none"> ■ Default value: Not connected
Minimum step frequency	Definition of the minimum step frequency of the connected stepper motor <ul style="list-style-type: none"> ■ Setting range: 0 kHz ... 1000 kHz ■ Default value: 0.000
Maximum step frequency	Definition of the maximum step frequency of the connected stepper motor <ul style="list-style-type: none"> ■ Setting range: 0 kHz ... 1000 kHz ■ Default value: 20.000
Drive enable	Assignment of the digital output for the drive enable according to pin layout <ul style="list-style-type: none"> ■ Default value: Not connected
Input for error signal	Assignment of the digital input for fault signal detection <ul style="list-style-type: none"> ■ Default value: Not active
Signal is low-active	Select how the fault signal is to be identified
Electronic axis clamping for active axis	Select whether the axis is to be clamped when it is on the target position Settings: <ul style="list-style-type: none"> ■ ON: The axis is clamped ■ OFF: The axis is not clamped ■ Default value: OFF
Target position reached	Assignment of the digital output when the axis is on the Target position in MDI mode or in program run <ul style="list-style-type: none"> ■ Default value: Not connected
Standstill monitoring for non-controlled axes	Selection of whether standstill monitoring is to be used Settings: <ul style="list-style-type: none"> ■ ON: Monitoring is activated ■ OFF: Monitoring is deactivated ■ Default value: OFF
Linear position tolerance for active standstill monitoring	Starting from this threshold value, movement of a noncontrolled linear axis is assumed and the central drive is stopped with a corresponding error message <ul style="list-style-type: none"> ■ Setting range: 0.005 mm ... 2.000 mm ■ Default value: 0.05 mm
Radial position tolerance for active standstill monitoring	Starting from this threshold value, movement of a noncontrolled rotary axis is assumed and the central drive is stopped with a corresponding error message <ul style="list-style-type: none"> ■ Setting range: 0.005 ° ... 45.000 ° ■ Default value: 0.5 °

Movement detection

Settings ► Axes ► General settings ► Central drive ► Movement detection

Parameter	Explanation
Movement detection	<p>Selection of whether movement detection is to be performed when the axis starts moving</p> <p>Settings:</p> <ul style="list-style-type: none"> ■ ON: Movement detection is activated ■ OFF: Access to the central drive can only be implemented via digital enabling signals of the individual axes ■ Default value: OFF
Umax	<p>Voltage that is output at the analog output in order to detect the direction of movement</p> <ul style="list-style-type: none"> ■ Setting range: 10 mV ... 1000 mV ■ Default value: 900
Start-up time	<p>Configuration of the acceleration behavior of the axes during starting for movement detection; the value of the of the start-up time must be matched with Umax</p> <ul style="list-style-type: none"> ■ Setting range: 5 ms ... 2880 ms ■ Default value: 50
Minimum traverse for movement detection	<p>Starting from this threshold value, the movement detection assumes a linear movement</p> <ul style="list-style-type: none"> ■ Setting range: 0.005 mm ... 2.000 mm ■ Default value: 0.05
Minimum rotation angle for movement detection	<p>Starting from this threshold value, the movement detection assumes a rotational movement</p> <ul style="list-style-type: none"> ■ Setting range: 0.005 ° ... 45.000 ° ■ Default value: 0.5
Timeout for abort of active movement detection	<p>If no movement is detected after this time limit has expired, the movement detection is aborted with a corresponding error message</p> <ul style="list-style-type: none"> ■ Setting range: 0.1 s ... 50 s ■ Default value: 5
Stop on movement of non-controlled axes	<p>Settings:</p> <ul style="list-style-type: none"> ■ ON: If the movement detection ascertains a movement of an axis that should not be traversed, the process is stopped with a corresponding error message; only axes to which a central drive has been assigned are monitored ■ OFF: The movement detection monitors only the axis that is to be moved. All of the other axes can move freely during movement detection ■ Default value: OFF

"Start central drive" special function

A special function can be added to the OEM bar. With this function, the motor of the central drive can be started in **Manual operation** mode. The voltage that is output results from the current feed rate and the feed-rate override.

The special function can only be activated in **Manual operation** mode.

Settings ▶ Service ▶ OEM area ▶ OEM bar ▶ Bar item ▶ Special functions

Parameter	Explanation
Start central drive	Direction: <ul style="list-style-type: none"> ■ Positive: The motor is started for positive traverse ■ Negative: The motor is started for negative traverse ■ Default value: Positive

i If a unipolar motor without direction enabling was assigned to the drive, the direction cannot be set here.

4.6.7 Configuring specific settings for Axis + NC

Depending on the setup of the connected machine tool, you can configure various parameters for your NC-controlled axes. First of all, the specific settings for the individual axes need to be made. Then you can make the general settings

Further information: "Configuring specific settings for Axis + NC", Page 110

Further information: "Configuring general settings for Axis + NC", Page 121

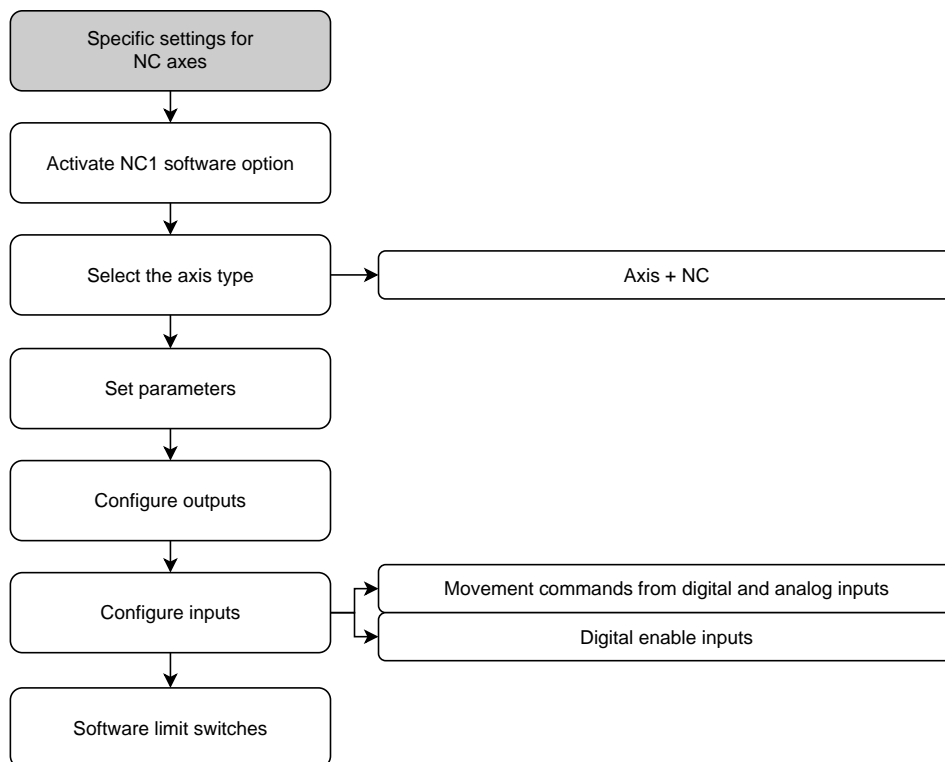

The flowchart below shows the configuration of the specific axis settings:



Axis + NC

Depending on the configuration of the connected machine tool, you must configure the inputs and outputs and further parameters of the NC axis prior to operation.

Settings ► Axes ► Axis name

Parameter	Explanation
Axis name	<p>Selecting the axis name displayed in the position preview Default setting: Not defined</p> <div style="border: 1px solid black; padding: 5px; margin-bottom: 5px;"> <p> You can configure the following axes: X, Z, Zo, C, S.</p> </div> <div style="border: 1px solid black; padding: 5px;"> <p> The axis name S is displayed in the selection list once you have selected Spindle, Gear spindle or Spindle with orientation under Axis type.</p> </div>
Axis type	<p>Definition of the axis type Settings:</p> <ul style="list-style-type: none"> ■ Axis + NC (possible for up to three axes): NC-controlled linear axis or rotary axis
Outputs	<p>Configuration of the Outputs for the NC function Further information: "Outputs", Page 113</p>
Inputs	<p>Configuration of the Inputs for the NC function Further information: "Inputs", Page 117</p>
Software limit switches	<p>Configuration of the Software limit switches Further information: "Software limit switches", Page 120</p>
Start-up time	<p>Configuration of the acceleration behavior and the braking behavior of the axis; time during which the drive accelerates from standstill to maximum feed rate Fmax or decelerates from maximum feed rate to standstill</p> <ul style="list-style-type: none"> ■ Setting range: 50 ms ... 10000 ms ■ Default value: 500
Kv factor P	<p>Proportional component of the position controller during positioning; effective during axis traverse when the position is not being approached or if the positioning window has not yet been reached (moving over following error)</p> <ul style="list-style-type: none"> ■ Setting range: 0.3 m/(min x mm) ... 6 m/(min x mm) ■ Default value: 2.5
Kv factor L	<p>Proportional component of the position controller during standstill; effective during positioning to target position as soon as the Positioning window in NC mode has been reached and with axis clamping (hold the axis at its position)</p> <ul style="list-style-type: none"> ■ Setting range: 0.3 m/(min x mm) ... 6 m/(min x mm) ■ Default value: 2.5
Maximum positioning error	<p>Definition of the maximum following error during positioning</p> <ul style="list-style-type: none"> ■ Setting range: 5 µm ... 1000 µm ■ Default value: 500

Parameter	Explanation
Maximum standstill error	Definition of the maximum position deviation at standstill <ul style="list-style-type: none"> ■ Setting range: 5 µm ... 1000 µm ■ Default value: 100
Positioning window	Input of the scaling factor for the positioning aid in MDI mode (only for manually operated linear axes) <ul style="list-style-type: none"> ■ Setting range: 0.020 mm ... 2.000 mm ■ Default value: 0.100
Positioning window in NC mode	The entered range around the target point. This area is the switching point to the Kv factor L
Minimum dwell time in manual positioning window	The entered required amount of time for the axes to be in the positioning window until the block is completed (only for manually operated linear axes) <ul style="list-style-type: none"> ■ Setting range: 0 ms ... 10000 ms ■ Default value: 0 ms
Minimum dwell time in positioning window	The entered required amount of time for the axes to be in the positioning window until the block is completed <ul style="list-style-type: none"> ■ Setting range: 0 ms ... 10000 ms ■ Default value: 0 ms

Start-up time

The start-up time allows you to control the acceleration behavior and the braking behavior of the axes. The start-up time always refers to **f_{max}**.

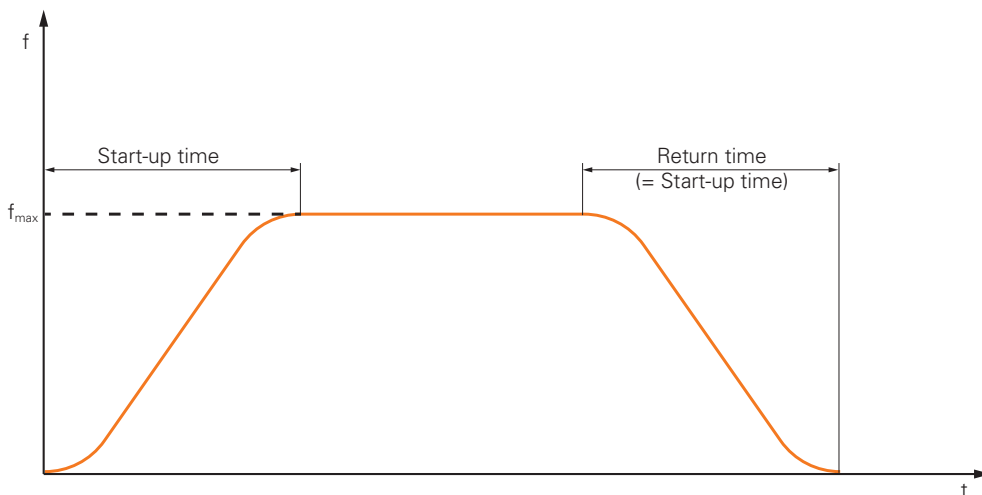

Kv factor P, Kv factor L and Positioning window in NC mode

The diagram below shows the relationship between the two parameters **Kv factor P**, **Kv factor L** and the **Positioning window in NC mode**.

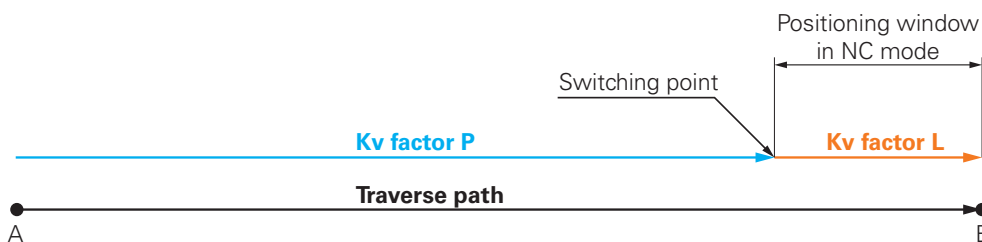

The **Kv factor P** is effective for the traverse path. As soon as the nominal values of the position controller that are calculated from the acceleration ramps reach the **Positioning window in NC mode**, this triggers a switchover to the **Kv factor L**. The target position is transferred to the position controller as the new nominal value.

HEIDENHAIN recommends that the two Kv factors not be set too far apart.

Outputs

In the settings for the outputs, you can configure your motor. Depending on the type of motor, you have to make different settings.

Settings ► Axes ► X, Y ... ► Outputs

Parameters	Explanation
Type of motor	Selection of the motor type Settings: <ul style="list-style-type: none"> ■ Bipolar servo motor: -10 V ... 10 V ■ Unipolar servo motor: 0 V ... 10 V ■ Stepper motor



Motor type: Bipolar servo motor

Parameter	Explanation
Analog output	Assignment of the analog output of the servo motor according to pin layout <ul style="list-style-type: none"> ■ Default value: Not connected
Analog output is inverted	If this function is active, the analog signal is inverted at the output <ul style="list-style-type: none"> ■ Default value: Not active
Open position control loop	If this function is active, the axis is operated with an open position control loop <div style="border: 1px solid black; padding: 5px; margin-top: 10px;"> <p>i When you are setting up the product, you can move the axes in an open position control loop. This way you determine appropriate parameters for Fmax and Umax.</p> </div> <ul style="list-style-type: none"> ■ Default value: Not active
Fmax	Definition of the feed rate attained at Umax <ul style="list-style-type: none"> ■ Setting range: 100 mm/min ... 10000 mm/min ■ Default value: 2000 <div style="border: 1px solid black; padding: 5px; margin-top: 10px;"> <p>i The Maximum machine speed cannot be exceeded, even if you have defined a higher feed rate for individual axes.</p> </div> <p>Further information: "Special settings", Page 124</p>
Umax	Maximum voltage that is output at the analog output in order to attain Fmax <ul style="list-style-type: none"> ■ Setting range: 1000 mV ... 10000 mV ■ Default value: 9000
Drive enable	Assignment of the digital output for the drive enable according to pin layout <ul style="list-style-type: none"> ■ Default value: Not connected
Target position reached	Assignment of the digital output when the axis is on the Target position in MDI mode or in program run <ul style="list-style-type: none"> ■ Default value: Not connected

Motor type: Unipolar servo motor

Parameter	Explanation
Analog output	Assignment of the analog output of the servo motor according to pin layout <ul style="list-style-type: none"> ■ Default value: Not connected
Analog output is inverted	If this function is active, the analog signal is inverted at the output <ul style="list-style-type: none"> ■ Default value: Not active
Open position control loop	If this function is active, the axis is operated with an open position control loop <div style="border: 1px solid black; padding: 5px; margin-top: 10px;"> <p>i When you are setting up the product, you can move the axes in an open position control loop. This way you determine appropriate parameters for Fmax and Umax.</p> </div> <ul style="list-style-type: none"> ■ Default value: Not active
Fmax	Definition of the feed rate attained at Umax <ul style="list-style-type: none"> ■ Setting range: 100 mm/min ... 10000 mm/min ■ Default value: 2000 <div style="border: 1px solid black; padding: 5px; margin-top: 10px;"> <p>i The Maximum machine speed cannot be exceeded, even if you have defined a higher feed rate for individual axes.</p> </div> <p>Further information: "Special settings", Page 124</p>
Umax	Maximum voltage that is output at the analog output in order to attain Fmax <ul style="list-style-type: none"> ■ Setting range: 1000 mV ... 10000 mV ■ Default value: 9000
Enable clockwise rotation	Assignment of the digital output for the clockwise spindle enable The input must be configured if the Unipolar servo motor motor type is selected <ul style="list-style-type: none"> ■ Default value: Not connected
Enable counterclockwise rotation	Assignment of the digital output for the counterclockwise spindle enable The input must be configured if the Unipolar servo motor motor type is selected <ul style="list-style-type: none"> ■ Default value: Not connected
Drive enable	Assignment of the digital output for the drive enable according to pin layout <ul style="list-style-type: none"> ■ Default value: Not connected
Target position reached	Assignment of the digital output when the axis is on the Target position in MDI mode or in program run <ul style="list-style-type: none"> ■ Default value: Not connected

Motor type: Stepper motor

Parameter	Explanation
Output for stepper motor	Assignment of the stepper motor output according to pin layout <ul style="list-style-type: none"> ■ Default value: Not connected
Minimum step frequency	Definition of the minimum step frequency of the connected stepper motor <ul style="list-style-type: none"> ■ Setting range: 0 kHz ... 1000 kHz ■ Default value: 0.000
Maximum step frequency	Definition of the maximum step frequency of the connected stepper motor <ul style="list-style-type: none"> ■ Setting range: 0 kHz ... 1000 kHz ■ Default value: 20.000
Direction signal is inverted	Activate this function if you want to change the direction of rotation of the connected stepper motor <ul style="list-style-type: none"> ■ Default value: Not active
Open position control loop	If this function is active, the axis is operated with an open position control loop <div data-bbox="686 1025 1461 1160" style="border: 1px solid black; padding: 5px; margin-top: 10px;"> <p> When you are setting up the product, you can move the axes in an open position control loop. This way you determine appropriate parameters for Fmax and Umax.</p> </div> <ul style="list-style-type: none"> ■ Default value: Not active
Fmax	Definition of the feed rate attained at Umax <ul style="list-style-type: none"> ■ Setting range: 100 mm/min ... 10000 mm/min ■ Default value: 2000 <div data-bbox="686 1357 1461 1491" style="border: 1px solid black; padding: 5px; margin-top: 10px;"> <p> The Maximum machine speed cannot be exceeded, even if you have defined a higher feed rate for individual axes.</p> </div> <p>Further information: "Special settings", Page 124</p>
Drive enable	Assignment of the digital output for the drive enable according to pin layout <ul style="list-style-type: none"> ■ Default value: Not connected
Target position reached	Assignment of the digital output when the axis is on the Target position in MDI mode or in program run <ul style="list-style-type: none"> ■ Default value: Not connected

Inputs

Settings ► Axes ► X, Y ... ► Inputs

Parameters	Explanation
Movement commands from digital input	Configuration of movement commands from external input devices via the digital input
Movement commands from analog input	Configuration of movement commands from external input devices via the analog input
Movement commands from electronic handwheel	Configuration of the movement commands from an electronic handwheel Further information: "Configuring an Electronic handwheel", Page 134
Digital enable inputs	Configuration of the digital inputs for the enable

Movement commands from digital input

Settings ► Axes ► X, Y ... ► Inputs ► Movement commands from digital input

Parameter	Explanation
Enable digital movement commands	<p>Enabling external movement commands (such as jog buttons on the operating panel of the machine) via the digital input</p> <ul style="list-style-type: none"> ■ Settings: ON or OFF ■ Default value: OFF <div style="border: 1px solid black; padding: 5px; margin-top: 10px;"> <p>i Digital movement commands are only available if the analog movement commands are deactivated. Further information: "Movement commands from analog input", Page 118</p> </div> <div style="border: 1px solid black; padding: 5px; margin-top: 10px;"> <p>i To be able to work with external movement commands you have to configure the following inputs:</p> <ul style="list-style-type: none"> ■ Input for digital movement command in positive direction ■ Input for digital movement command in negative direction </div>
Input for digital movement command in positive direction	<p>Assignment of the digital input for the movement command in the positive direction according to pin layout Default value: Not connected</p>
Input for digital movement command in negative direction	<p>Assignment of the digital input for the movement command in the negative direction according to pin layout Default value: Not connected</p>

Movement commands from analog input

Settings ► Axes ► X, Y ... ► Inputs ► Movement commands from analog input

Parameter	Explanation
Enable analog movement commands	<p>Enabling movement commands from external input devices (such as a joystick) via the analog input</p> <ul style="list-style-type: none"> ■ Settings: ON or OFF ■ Default value: OFF <div style="border: 1px solid black; padding: 5px; margin-top: 10px;"> <p>i Analog movement commands are only available if the digital movement commands are deactivated. Further information: "Movement commands from digital input", Page 117</p> </div> <div style="border: 1px solid black; padding: 5px; margin-top: 10px;"> <p>i To be able to work with external movement commands you have to configure the Input for analog movement commands</p> </div>
Input for analog movement commands	<p>Assignment of the analog input for the movement commands according to pin layout. The analog voltage at these inputs must be within a range of 0 V...5 V</p> <p>Default value: Not connected</p>
Dead band	<p>Enter the entire voltage range in percent. The Dead band defines the input voltage range around the zero position at which the supplied voltage is not yet interpreted as a movement command. The value refers to the entire voltage range.</p> <ul style="list-style-type: none"> ■ Setting range: 0 % ... 100 % ■ Default value: 10 %
Invert the analog input	<p>If this function is active, the analog input is inverted. With an inverted input, a higher input voltage leads to a feed rate in negative direction. A lower input voltage results in a feed rate in positive direction</p> <p>Default value: Not active</p>
Fmax	<p>Fmax defines the maximum feed rate of the axis that can be reached via movement commands from the analog input</p> <ul style="list-style-type: none"> ■ Setting range: 100 mm/min ... 2000 mm/min ■ Default value: 2000
Fmax for smooth feed	<p>Definition of the feed rate for a slower feed rate with a fully deflected joystick</p> <ul style="list-style-type: none"> ■ Setting range: 100 mm/min ... 2000 mm/min ■ Default value: 200 <div style="border: 1px solid black; padding: 5px; margin-top: 10px;"> <p>i To be able to use the function, an input must be assigned in Smooth feed selection for analog movement commands Further information: "Inputs (Switching functions)", Page 121</p> </div>
Set input voltage	<p>Starts a teach sequence to determine the input voltage</p>

Digital enable inputs

Settings ► Axes ► X, Y ... ► Inputs ► Digital enable inputs

Parameter	Explanation
Input for error signal	<p>Assignment of the digital input according to pin layout</p> <p>The connected servo amplifier outputs the signal. The product interprets the signal as an error signal. If an error is present at the input, the axis is disconnected from power and abruptly brought to a standstill without a ramp. An error message is displayed on the product</p> <p>Default value: Not connected</p> <p>Signal is low-active</p> <ul style="list-style-type: none"> ■ If the function is active, a "low" signal at the input is interpreted as an error. Release is given with a "high" signal
Input for activated mechanical handwheel	<p>Assignment of the digital input for activation of the mechanical handwheel</p> <p>If the input is present, no NC movements can be executed with the axis. If the axis is in closed-loop control and the Input for activated mechanical handwheel switches, the axis is slowed down in a controlled manner and taken out of closed-loop control. When the input is no longer present, the axis can be moved in closed-loop control again</p> <p>Default value: Not connected</p> <p>Signal is low-active</p> <ul style="list-style-type: none"> ■ If the function is active, a "low" signal at the input is interpreted as a mechanical handwheel
Input for active access to the central drive	<p>Assignment of the digital input for activating access to the central drive</p> <p>If a signal is present at this input, the axis gets access to the central drive</p> <p>Default value: Not connected</p> <p>Signal is low-active</p> <ul style="list-style-type: none"> ■ If the function is active, access to the central drive is granted when a "low" signal is present at the input
Input for negative traverse direction of axis	<p>Assignment of the digital input for enabling the negative traverse direction of an axis</p> <p>If a signal is present at this input, the negative traverse direction of an axis is enabled via the central drive. Otherwise, the positive traverse direction applies</p> <p>Default value: Not connected</p> <p>Signal is low-active</p> <ul style="list-style-type: none"> ■ If the function is active, a "low" signal at the input is interpreted as approval

Software limit switches

Function of the software limit switches

Software limit switches limit the permissible range of traverse of an NC-controlled axis in the positive or negative direction. If the software limit switches are active, the axis is slowed down early enough to come to a standstill at the latest when reaching the software limit switch.

If a program step contains a nominal position that is outside the permissible range of traverse, the program step is acknowledged with an error message and the axis is not traversed. If the actual position of the axis is outside the permissible range of traverse, the axis can only be moved in the direction of the machine datum. A corresponding message is displayed on the product.



The software limit switches must be specified before setting a preset.

Settings ► Axes ► X, Y ... ► Software limit switches

Parameters	Explanation
Software limit switches	Use of the software limit switch <ul style="list-style-type: none"> ■ Settings: ON or OFF ■ Default value: OFF
Limit switch in positive direction	Distance in the positive direction from the machine datum to the software limit switch (including Reference point displacement , if activated) Unit: millimeters <ul style="list-style-type: none"> ■ Default value: 0
Limit switch in negative direction	Distance in the negative direction from the machine datum to the software limit switch (including Reference point displacement , if activated) Unit: millimeters <ul style="list-style-type: none"> ■ Default value: 0

4.6.8 Configuring general settings for Axis + NC

When you have configured the specific settings on every axis + NC, you can make the general settings for the closed-loop axes. Depending on the setup of your machine, you do not have to make all of the settings.

The flowchart below shows the configuration of the general settings:



Switching functions

Settings ► Axes ► General settings ► Switching functions

i The switching functions must not be used as a part of a safety function.

Parameters	Explanation
Inputs	Assignment of the digital input for the respective switching function according to the pin layout Further information: "Inputs (Switching functions)", Page 121
Outputs	Assignment of the digital output for the respective switching function according to the pin layout Further information: "Outputs (Switching functions)", Page 123

Inputs (Switching functions)

i The switching functions must not be used as a part of a safety function.

Settings ► Axes ► General settings ► Switching functions ► Inputs

Parameter	Explanation
Control voltage on	Assignment of the digital input for querying the external control voltage (e.g. for the machine to be controlled) <ul style="list-style-type: none"> Default value: Not connected
Emergency stop active	Assignment of the digital input for querying whether an externally connected emergency stop switch was activated <ul style="list-style-type: none"> Default value: Not connected

Parameter	Explanation
Rapid traverse	<p>Assignment of the digital input for a push button that activates rapid traverse. The rapid traverse is active as long as the push button is pressed and held.</p> <p>If rapid traverse is activated, feed rate limitation is ignored by the feed rate override and the axes traverse at rapid traverse.</p> <ul style="list-style-type: none"> ■ Default value: Not connected
Automatic feed	<p>Assignment of the digital input for a push button with the following effect:</p> <ul style="list-style-type: none"> ■ Manual operation: Pressing the button activates the automatic feed rate during axis movements that are controlled via the jog buttons. The axis continues to move until it reaches its next limit switch or until the push button is pressed again. The automatic feed rate only functions for axes for which limit switches have been configured ■ MDI mode and Program Run: the push button functions as an NC-START key. Pressing the push button starts and interrupts the cycles of a program block ■ Default value: Not connected <div data-bbox="686 1003 1465 1131" style="border: 1px solid black; padding: 5px;"> <p>i Pressing the button again will only then cause a pause or stop if no specific Stop of the automatic feed input was configured.</p> </div> <div data-bbox="686 1153 1465 1281" style="border: 1px solid black; padding: 5px;"> <p>i If no digital input is assigned to the Automatic feed parameter, the NC-START key will be displayed during the execution of an MDI block or a program.</p> </div>
Stop of the automatic feed	<p>Assignment of the digital input for a push button with the following effect:</p> <ul style="list-style-type: none"> ■ Manual operation: Pressing the button stops the automatic feed rate during axis movements that are controlled via the jog buttons ■ MDI mode and Program Run: The push button functions as an NC STOP key. Pressing the push button stops and interrupts the cycles of a program block ■ Default value: Not connected
Smooth feed selection for analog movement commands	<p>Assignment of the digital input to select a smoother feed if the entire input voltage range is used</p> <ul style="list-style-type: none"> ■ Default value: Not connected <p>Further information: "Movement commands from analog input", Page 118</p>
Enable spindle-independent manual movement commands	<p>Assignment of the digital input to execute manual NC movements that are independent of the spindle. The spindle is standing still and the axes are moved in feed mode mm/min</p> <ul style="list-style-type: none"> ■ Default value: Not connected <div data-bbox="686 1966 1465 2072" style="border: 1px solid black; padding: 5px;"> <p>i Spindle-independent manual movements are only possible if there is a high level at the input.</p> </div>

Outputs (Switching functions)

 The switching functions must not be used as a part of a safety function.

Settings ► Axes ► General settings ► Switching functions ► Outputs

Parameter	Explanation
Coolant	Assignment of the digital output for activating or deactivating the coolant supply of the machine tool <ul style="list-style-type: none"> Default value: Not connected
Operational readiness	Assignment of the relay output that is set if a severe error during position feedback control (e.g., positioning error or standstill error) occurs on an axis. The error results in an interruption of the axis feedback control and power disconnection of the configured analog outputs of the axis <ul style="list-style-type: none"> Default value: Not connected
User-defined switching function	Assignment of the relay output that activates some seconds after shutdown of the product. Example: The circuit can couple the switch-on/off of the product to the switch-on/off of the machine tool to be controlled. <ul style="list-style-type: none"> Default value: Not connected
Autostart light	Assignment of the digital output for visual status display of the program run. Lighting is active if a cycle is executed in MDI mode or program run or if automatic feed rate is activated in Manual mode. Lighting flashes if an active cycle is interrupted and can be continued by pressing the NC START key. <ul style="list-style-type: none"> Default value: Not connected

Overrides

Settings ► Axes ► General settings ► Overrides

Parameters	Explanation
Input for feed override	Assignment of the analog input (e.g. of the feed-rate potentiometer) for the feed rate override according to pin layout Default value: Not connected
Umax	Definition of the maximum output voltage. The maximum voltage corresponds to 100 % of the feed-rate potentiometer <ul style="list-style-type: none"> Setting range: 0 mV ... 5000 mV Default value: 5000
Lower dead band	Definition of the lower dead band. The lower dead band starts at 0 % and defines the area within which no movement takes places yet. <ul style="list-style-type: none"> Setting range: 0 % ... 100 % Default value: 0.000

Special settings

Settings ► Axes ► General settings ► Special settings

Parameters	Explanation
Electronic axis clamping on axis halt	<p>Setting for electronic axis clamping when the axis is at a standstill</p> <p>Settings:</p> <ul style="list-style-type: none"> ■ ON: The axis is clamped on standstill of the axis ■ OFF: The axis is not clamped on standstill of the axis ■ Default value: OFF
Only single axis movement via jog buttons	<p>Definition of the axis movements that are possible with the traverse keys</p> <p>Settings:</p> <ul style="list-style-type: none"> ■ ON: Only a single axis can be moved ■ OFF: Several axes can be moved simultaneously ■ Default value: OFF
Maximum machine speed for linear movements	<p>Definition of the maximum speed at which NC-controlled linear axes can be moved</p> <ul style="list-style-type: none"> ■ Setting range: 100 mm/min ... 10000 mm/min ■ Default value: 2000 <div style="border: 1px solid black; padding: 5px; margin-top: 10px;"> <p> The Maximum machine speed cannot be exceeded, even if you have defined a higher feed rate for individual axes.</p> </div>
Maximum machine speed for radial movements	<p>Definition of the maximum speed at which NC-controlled rotational axes can be moved.</p> <ul style="list-style-type: none"> ■ Setting range: 72000 °/min ... 3600000 °/min ■ Default value: 720000
Rapid traverse speed for linear movements	<p>Definition of the speed at which NC-controlled linear axes are moved at rapid traverse</p> <ul style="list-style-type: none"> ■ Setting range: 100 mm/min ... 10000 mm/min ■ Default value: 2000
Rapid traverse speed for radial movements	<p>Definition of the speed at which NC-controlled rotational axes are moved at rapid traverse</p> <ul style="list-style-type: none"> ■ Setting range: 72000 °/min ... 3600000 °/min ■ Default value: 720000
Velocity feedforward control for position feedback control	<p>Setting the Velocity feedforward control for position feedback control of interpolated NC movements. Reducing the following error directly affects the speed control loop</p> <p>Settings:</p> <ul style="list-style-type: none"> ■ None ■ t - 2 ms ■ t - 4 ms ■ t - 6 ms ■ Default value: None

Function of the velocity feedforward control

The velocity feedforward control influences the command action of the position-controlled drive. It directly affects the speed control loop as a control factor and can reduce the following error without compromising the stability of the control loop.

If you configure the **Velocity feedforward control for position feedback control** parameter, the feedforward control calculates the following error that, based on the current velocity, would result in the position controller and uses the calculated value to determine the nominal velocity value to be added to the position controller output.

Configuring virtual axis keys

Depending on the setup of the connected machine tool, you can configure virtual axis keys that allow you to traverse the NC axes.

Settings ► Axes ► General settings ► Virtual axis keys

Parameter	Explanation
Enable movement commands for virtual axis keys	Assignment of the digital input for the confirmation key, for example at the operating panel of the machine to enable the virtual traverse keys. Assignment of an input is optional; if you assign an input, the virtual axis keys work only if a signal is present at the configured input Default value: Not connected
	Adding virtual axis keys (jog buttons) to an axis; tapping the Add button opens a dialog box in which you can select the desired axis
Axis	Selecting the axis to be moved with the virtual axis keys
Start-Stop traverse mode	Defines whether the keys are to be configured as switches or push buttons Settings: <ul style="list-style-type: none"> ■ ON: The axis key is configured as a switch. Traverse can be started by tapping once and stopped by tapping again ■ OFF: The axis key is configured as a button. Traverse continues only as long as the button is pressed and held ■ Default value: OFF
Remove the entry	The axis keys for the axis are removed.

4.6.9 Configuring the spindle axis

Depending on the configuration of the connected machine tool, you must configure the inputs and outputs and further parameters of the spindle axis prior to operation. If your machine tool uses a **Gear spindle**, then you can also configure the corresponding gear stages.

You can activate a **Spindle with orientation**. You can use the **Spindle with orientation** for **Thread cutting**.

A spindle axis can be started and stopped either via the M3/M4 **M functions** or manually.

If no M3/M4 **M functions** are available, then the spindle can be operated only manually. To do so, configure the parameters of the **Spindle start** and **Spindle stop** digital inputs.

Control of the spindle axis	Analog output	Inputs	
		Spindle start	Spindle stop
Manually	Assigned	Assigned	Assigned
M functions M3/M4	Assigned	Not connected	Not connected

The following flowchart shows the configuration procedure:

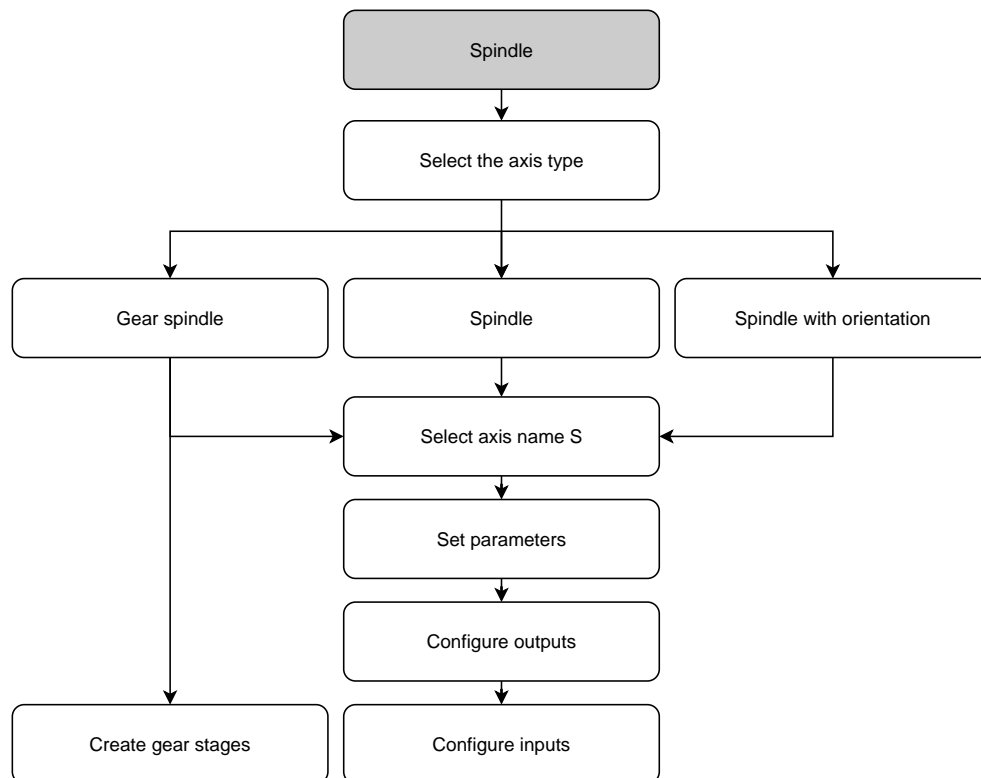

Spindle axis S

Settings ► Axes ► Spindle axis S

Parameters	Explanation
Axis name	Definition of the axis name displayed in the position preview Settings: <ul style="list-style-type: none"> ■ S ■ Default setting: S
Axis type	Definition of the axis type Settings: <ul style="list-style-type: none"> ■ Not defined ■ Spindle ■ Gear spindle ■ Spindle with orientation
Encoder	Configuration of the connected encoder Further information: "Overview of typical encoders", Page 92
Error compensation	Configuration of the linear error compensation LEC or segmented linear error compensation SLEC Further information: "Performing error compensation", Page 99
Outputs	Configuration of the Outputs for the spindle Further information: "Outputs (S)", Page 129
Inputs	Configuration of the Inputs for the spindle Further information: "Inputs (S)", Page 131
Gear stages	Configuration of the Gear stages for the Gear spindle Further information: "Gear stages", Page 134
Gear stage selection through an external signal	Selection of the Gear stages of the Gear spindle through external signals. To be able to switch the Gear stages , DC 24 V must be present at X105.17/18/36 Settings <ul style="list-style-type: none"> ■ ON: The Gear stages are selected via external signals ■ OFF: The Gear stages are selected manually in the operating modes ■ Default value: OFF
Start-up time for upper spindle speed range	Setting the Start-up time from standstill to the maximum spindle speed Smax for the upper spindle speed range <ul style="list-style-type: none"> ■ Setting range: 50 ms ... 10000 ms ■ Default value: 500
Start-up time for lower spindle speed range	Setting the Start-up time from standstill to the maximum spindle speed Smax for the lower spindle speed range <ul style="list-style-type: none"> ■ Setting range: 50 ms ... 10000 ms ■ Default value: 500
Break point of characteristic curve for start-up times	Definition of the limit between the upper and the lower spindle speed range. The value of the start-up time must be matched to Smax <ul style="list-style-type: none"> ■ Setting range: 0 rpm ... 2000 rpm ■ Default value: 1500

Parameters	Explanation
Minimum spindle speed	Definition of the minimum spindle speed <ul style="list-style-type: none"> ■ Setting range: 0 rpm ... 500 rpm ■ Default value: 50
Maximum spindle speed for oriented spindle stop	Definition of the maximum spindle speed for oriented spindle stop <ul style="list-style-type: none"> ■ Setting range: 0 rpm ... 500 rpm ■ Default value: 30
<div style="border: 1px solid black; padding: 5px; display: inline-block;"> <p>i To use the function, you have to assign an input to the Spindle position parameter. Further information: "Inputs (S)", Page 131</p> </div>	
Maximum spindle speed for thread cutting	Setting the maximum spindle speed for thread cutting during tapping <ul style="list-style-type: none"> ■ Setting range: 100 rpm ... 2000 rpm ■ Default value: 1000
Maximum spindle speed in positioning mode	Setting the maximum spindle speed in controlled operation for the Thread Cutting machining cycles in the Turning application <ul style="list-style-type: none"> ■ Setting range: 100 rpm ... 200 rpm ■ Default value: 1500

Gear stage selection through an external signal

To be able to switch the **Gear stages**, external DC 24 V must be present at pin X105.17, X105.18 or X105.36.

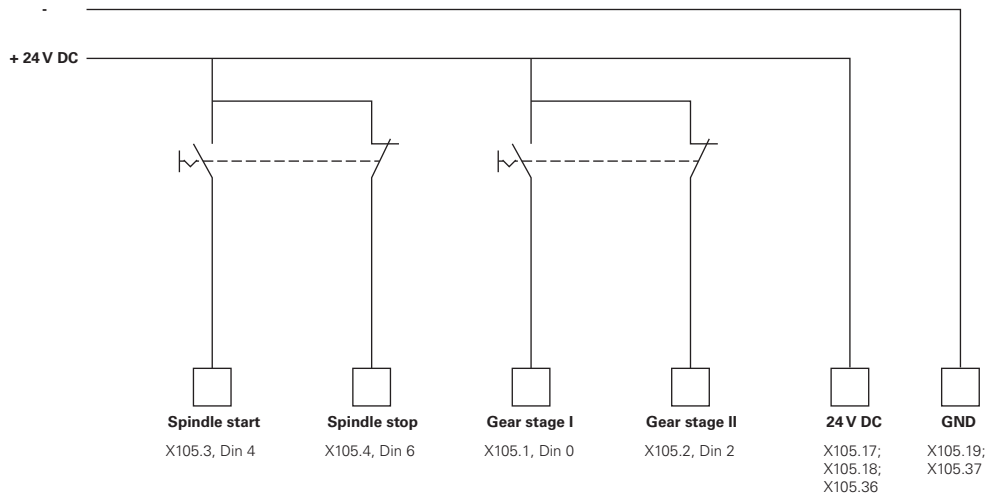

Start-up times of a spindle

The **Break point of characteristic curve for start-up times** value divides the spindle speeds into two ranges. For each range you can define an individual start-up time:

- **Start-up time for upper spindle speed range:** Time within which the motor accelerates from standstill to the maximum speed **S_{max}**
- **Start-up time for lower spindle speed range:** Time within which the motor accelerates from standstill to the maximum speed **S_{max}**

Outputs (S)

In the settings for the outputs, you can configure your motor. Depending on the type of motor, you have to make different settings.

Settings ► Axes ► S ► Outputs

Parameters	Explanation
Type of motor	<ul style="list-style-type: none"> ■ Bipolar servo motor: -10 V ... 10 V ■ Unipolar servo motor: 0 V ... 10 V ■ Stepper motor

Motor type: Bipolar servo motor

Settings ► Axes ► S ► Outputs

Parameter	Explanation
Analog output	Assignment of the analog output according to pin layout <ul style="list-style-type: none"> ■ Default value: Not connected
Analog output is inverted	If this function is active, the analog signal is inverted at the output <ul style="list-style-type: none"> ■ Default value: Not active
Smax	Definition of the Spindle speed attained at Umax <ul style="list-style-type: none"> ■ Setting range: 1 rpm ... 10000 rpm ■ Default value: 2000 Further information: "Special settings", Page 124
Umax	Maximum voltage that is output at the analog output in order to attain Smax <ul style="list-style-type: none"> ■ Setting range: 1000 mV ... 10000 mV ■ Default value: 9000
Drive enable	Assignment of the digital output for the drive enable according to pin layout <ul style="list-style-type: none"> ■ Default value: Not connected

Motor type: Unipolar servo motor

Settings ► Axes ► S ► Outputs

Parameter	Explanation
Analog output	Assignment of the analog output according to pin layout <ul style="list-style-type: none"> Default value: Not connected
Analog output is inverted	If this function is active, the analog signal is inverted at the output <ul style="list-style-type: none"> Default value: Not active
Smax	Definition of the Spindle speed attained at Umax <ul style="list-style-type: none"> Setting range: 1 rpm ... 10000 rpm Default value: 2000 Further information: "Special settings", Page 124
Umax	Maximum voltage that is output at the analog output in order to attain Smax <ul style="list-style-type: none"> Setting range: 1000 mV ... 10000 mV Default value: 9000
Enable clockwise rotation	Assignment of the digital output for the clockwise spindle enable The input must be configured if the Unipolar servo motor motor type is selected <ul style="list-style-type: none"> Default value: Not connected
Enable counterclockwise rotation	Assignment of the digital output for the clockwise spindle enable The input must be configured if the Unipolar servo motor motor type is selected <ul style="list-style-type: none"> Default value: Not connected
Drive enable	Assignment of the digital output for the drive enable according to pin layout <ul style="list-style-type: none"> Default value: Not connected

Motor type: Stepper motor

Parameter	Explanation
Output for stepper motor	Assignment of the stepper motor output according to pin layout <ul style="list-style-type: none"> ■ Default value: Not connected
Minimum step frequency	Definition of the minimum step frequency of the connected stepper motor <ul style="list-style-type: none"> ■ Setting range: 0 kHz ... 1000 kHz ■ Default value: 0.000
Maximum step frequency	Definition of the maximum step frequency of the connected stepper motor <ul style="list-style-type: none"> ■ Setting range: 0 kHz ... 1000 kHz ■ Default value: 20.000
Direction signal is inverted	Activate this function if you want to change the direction of rotation of the connected stepper motor <ul style="list-style-type: none"> ■ Default value: Not active
Smax	Definition of the Spindle speed attained at Umax <ul style="list-style-type: none"> ■ Setting range: 1 rpm ... 10000 rpm ■ Default value: 2000 Further information: "Special settings", Page 124
Drive enable	Assignment of the digital output for the drive enable according to pin layout <ul style="list-style-type: none"> ■ Default value: Not connected

Inputs (S)

Settings ► Axes ► S ► Inputs

Parameters	Explanation
Movement commands from digital input	Configuration of the movement commands for the digital spindle input; e.g., jog buttons for spindle start and spindle stop
Digital enable inputs	Configuration of the digital inputs for the spindle enable
Spindle speed display via analog input	Configuration of the display of the actual speed; assign the input if the actual speed is to be displayed; indication of the spindle speed at an input voltage of 5 V



Movement commands from digital input (S)

Settings ► Axes ► S ► Inputs ► Movement commands from digital input

Parameter	Explanation
Enable digital movement commands	Use of the digital movement commands <ul style="list-style-type: none"> Settings: ON or OFF Default value: OFF
Spindle start	Assignment of the digital input for the spindle start according to pin layout <ul style="list-style-type: none"> Default value: Not connected
Spindle stop	Assignment of the digital input for the spindle stop according to pin layout <ul style="list-style-type: none"> Default value: Not connected

Digital enable inputs (S)

Settings ► Axes ► S ► Inputs ► Digital enable inputs

Parameter	Explanation
Spindle ready	Assignment of a digital input; indicates that the spindle is in reliable condition <ul style="list-style-type: none"> Default value: Not connected
Spindle interrupt	Assignment of a digital input; in active state it immediately disconnects from power the configured analog output of the spindle. A spindle movement is stopped without a ramp, axes with automatic traverse are stopped if applicable and spindle activation is prevented. <div data-bbox="686 1317 1461 1413" style="border: 1px solid black; padding: 5px; margin-top: 10px;"> <p> The machine tool builder is responsible for the immediate stopping of the spindles.</p> </div> <ul style="list-style-type: none"> Default value: Not connected
Spindle protection device	Assignment of a digital input; indicates whether an existing spindle protection device is open or closed. This signal influences error messages and program run. <div data-bbox="686 1599 1461 1729" style="border: 1px solid black; padding: 5px; margin-top: 10px;"> <p> The machine tool builder is responsible for the immediate shutdown of the spindles with opened spindle protection.</p> </div> <ul style="list-style-type: none"> Default value: Not connected
Spindle sleeve final position +	Assignment of a digital input for the upper limit switch of the sleeves. The input is used for reversing the spindle with thread cutting <ul style="list-style-type: none"> Default value: Not connected
Spindle sleeve final position -	Assignment of a digital input for the lower limit switch of the sleeves. The input is used for reversing the spindle with thread cutting <ul style="list-style-type: none"> Default value: Not connected

Parameter	Explanation
Spindle position	Assignment of a digital input; if a spindle speed was set under Maximum spindle speed for oriented spindle stop , the signal switches the spindle to de-energized state upon stopping at a defined position <ul style="list-style-type: none"> Default value: Not connected
Enable spindle CCW	Assignment of a digital input for counterclockwise direction of spindle rotation according to pin layout <ul style="list-style-type: none"> Default value: Not connected <div style="border: 1px solid black; padding: 5px; margin-top: 10px;"> <p>i The external input signal takes precedence over the direction of rotation set in the OEM bar or in the Programming menu.</p> </div> <div style="border: 1px solid black; padding: 5px; margin-top: 10px;"> <p>i The external signal is only evaluated if a high level is constantly present at the digital input for Spindle start.</p> </div>

Spindle speed display via analog input (S)

Settings ► Axes ► S ► Inputs ► Spindle speed display via analog input

Parameter	Explanation
Spindle speed display via analog input	Activation of spindle-speed display in the position display <ul style="list-style-type: none"> Settings: ON or OFF Default value: OFF
Input for spindle speed display	Assignment of the analog input according to pin layout <ul style="list-style-type: none"> Default value: Not connected
Spindle speed at input voltage 5 V	Entering the spindle speed at an input voltage of 5 V <ul style="list-style-type: none"> Default value: 2000 <div style="border: 1px solid black; padding: 5px; margin-top: 10px;"> <p>i The measured input voltage is offset against the factor Spindle speed at input voltage 5 V. The result is shown as actual speed in the position display.</p> </div>

Adding Gear stages

Settings ► Axes ► S ► Gear stages ► +

Parameter	Explanation
	Adding a new gear stage with default name

Gear stages

Settings ► Axes ► S ► Gear stages

Parameter	Explanation
Name	Entry of the name for the gear stage <ul style="list-style-type: none"> ■ Default value: Stage [n]
Smax	Definition of the Spindle speed attained with Umax <ul style="list-style-type: none"> ■ Setting range: 1 rpm ... 10000 rpm ■ Default value: 2000
Start-up time for upper spindle speed range	Definition of the required Start-up time until Smax is reached <ul style="list-style-type: none"> ■ Setting range: 50 ms ... 10000 ms ■ Default value: 500
Start-up time for lower spindle speed range	Definition of the required Start-up time until Smax is reached <ul style="list-style-type: none"> ■ Setting range: 50 ms ... 10000 ms ■ Default value: 500
Break point of characteristic curve for start-up times	Setting of the spindle speed that marks the transition from the upper to the lower spindle speed range <ul style="list-style-type: none"> ■ Setting range: 0 rpm ... 2000 rpm ■ Default value: 1500
Minimum spindle speed	Definition of the minimum spindle speed <ul style="list-style-type: none"> ■ Setting range: 0 rpm ... 10000 rpm ■ Default value: 50
Remove	Removal of the selected gear stage

4.6.10 Configuring an Electronic handwheel

If you want to use an electronic handwheel to move an axis, you need to configure various parameters. The following provides an overview of the configuration of the electronic handwheel.

Proceed as follows:

- Select the **Electronic handwheel** axis type
- Enter the encoders settings for the handwheel being used
- Assign the handwheel to the desired axis

Select the Electronic handwheel axis type

Settings ► Axes ► <Axis name>

Parameter	Explanation
Axis type	Definition of the axis type <ul style="list-style-type: none"> ■ Electronic handwheel

Configuring the encoder of the electronic handwheel

You first enter the parameters of the encoder used for the electronic handwheel.

Settings ► Axes ► H1, H2, ... ► Encoder

Further information: "Configuring the axes for encoders with a 1 V_{PP} or 11 μA_{PP} interface", Page 94

Further information: "Configuring axes for encoders with EnDat interface", Page 93

Assigning and adjusting the handwheel

Now you assign the handwheel to the axis you want to move and define the settings for the handwheel. Adapt these values based on the requirements of your machine.

Settings ▶ Axes ▶ X, Y ... ▶ Inputs ▶ Movement commands from electronic handwheel

Parameter	Explanation
Enable movement commands from electronic handwheel	Enabling of movement commands from an electronic handwheel <ul style="list-style-type: none"> ■ Settings: ON or OFF ■ Default value: OFF
Selection of the electronic handwheel	In the drop-down list, select the electronic handwheel you want to use
Invert the counting direction	Activate this function if you want to invert the counting direction
Calculation of the feed override in handwheel mode	When the function is active, the current feed-rate override is taken into account in a handwheel movement
Calculation of nominal feed rate in handwheel mode	When the function is active, the currently entered feed rate is taken into account in a handwheel movement
Position difference per revolution	Entry of the position difference per revolution. This parameter defines the linear movement per handwheel revolution <ul style="list-style-type: none"> ■ Setting range: 0.001 mm ... 8000 mm ■ Default value: 2.5
Maximum position difference	Entry of maximum position difference. This parameter allows you to limit the buffer that the handwheel has built up for traversing the linear axis <ul style="list-style-type: none"> ■ Setting range: 0.005 mm ... 20000 mm ■ Default value: 20
Resolution	Entry of the electronic handwheel resolution for defining how the electronic handwheel should move the axis. This parameter defines how fine or coarse the axis movement will be <ul style="list-style-type: none"> ■ Setting range: 1 µm ... 65000 µm ■ Default value: 1
Permissive button for movement commands from electronic handwheel	Assignment of the digital input for activating the electronic handwheel

4.6.11 Coupling axes

If you couple axes with each other, the product offsets the position values of the two axes according to the selected calculation type. The position display shows only the principal axis with the calculated position value.



Settings ► Axes ► <Axis name>

Parameter	Explanation
Axis type	<p>Definition of the axis type</p> <p>Settings:</p> <ul style="list-style-type: none"> ■ Coupled axis: Axis whose position value is offset against a principal axis <div style="border: 1px solid black; padding: 5px; margin: 5px 0;"> <p>i Coupled axes do not appear in the position display. The position axis shows only the principal axis with the calculated position value of both axes.</p> </div> <div style="border: 1px solid black; padding: 5px; margin: 5px 0;"> <p>i For coupled axes, the product adapts the axis name automatically. The axis name consists of the name of the principal axis and the selected calculation type, e.g. +X.</p> </div>
Coupled main axis	<p>Selecting the principal axis to be coupled with the axis</p> <p>Default value: None</p>
Calculation with main axis	<p>Calculation type for the position values of the principal (main) axis and coupled axis</p> <p>Settings:</p> <ul style="list-style-type: none"> ■ +: The position values are added (principal axis + coupled axis) ■ -: The position values are subtracted (principal axis – coupled axis) ■ Default value: +

4.6.12 Diameter axis

If you do not wish to work with a preset table or tool table, you can activate direct input via the axis label X.

Settings ▶ Axes ▶ General settings ▶ Diameter axis

Parameter	Explanation
Preset setting via axis label	<p>Defines whether the direct setting of a preset via the axis label is activated</p> <div style="border: 1px solid black; padding: 5px; margin-top: 10px;"> <p> Preset setting via the axis label can lead to unintentional shifting of the preset away from the center of the workpiece.</p> </div> <p>Settings:</p> <ul style="list-style-type: none"> ■ ON: Preset setting via axis label is active ■ OFF: Preset setting via axis label is inactive ■ Default value: OFF
Consider presets with CSS	<p>Defines whether the presets are considered in CSS mode</p> <div style="border: 1px solid black; padding: 5px; margin-top: 10px;"> <p> A consideration of the presets in CSS mode can lead to CSS no longer acting on the physical center of the workpiece.</p> </div> <p>Settings:</p> <ul style="list-style-type: none"> ■ ON: Consideration of the presets in CSS mode is active ■ OFF: Consideration of the presets in CSS mode is inactive ■ Default value: OFF

4.6.13 Configuring thread cutting (NC software option)

You have the option of turning threads NC-controlled on your lathe. The spindle with orientation S or the C axis configured as NC axis can be used as rotational axis for thread cutting.

Prerequisites:

- Z axis configured as NC axis
- X axis configured as NC axis
- C axis configured as NC axis or spindle with orientation



Please note that with the **Encoder configuration for axis C**, the **Display mode** is configured either from **0° ... 360°** or from **-180° ... 180°**. The **Display mode -∞ ... ∞** is not supported.

Settings ► Axes ► General settings ► Thread cutting

Parameter	Explanation
Rotation axis	Selecting the rotational axis for thread cutting Depending on the machine setup and the axis configuration, the following rotational axes are available: <ul style="list-style-type: none"> ■ None ■ S axis (spindle) ■ C axis
Speed for pre-positioning the rotational axis	Setting the speed for pre-positioning the rotational axis S : <ul style="list-style-type: none"> ■ Setting range: 0 rpm ... 2000 rpm ■ Default value: 0
Feed rate for pre-positioning the rotational axis	Setting the feed rate for pre-positioning the rotational axis C : <ul style="list-style-type: none"> ■ Setting range: 0 °/min ... 2000 °/min ■ Default value: 0

4.6.14 Reference marks

Settings ► Axes ► General settings ► Reference marks

Parameters	Explanation
Reference mark search after unit start	Setting for the reference mark search after unit start Settings: <ul style="list-style-type: none"> ■ ON: The reference mark search must be performed after startup ■ OFF: No prompt for a mandatory reference mark search is displayed after startup of the product ■ Default value: ON
All users can cancel reference mark search	Specifies whether the reference mark search can be canceled by all user types Settings <ul style="list-style-type: none"> ■ ON: The reference mark search can be canceled by users of any type ■ OFF: The reference mark search can only be canceled by users of the OEM or Setup type ■ Default value: OFF
Reference mark search	Start starts the reference mark search and opens the workspace
Reference mark search status	Indicates whether the reference mark search was successful Display: <ul style="list-style-type: none"> ■ Successful ■ Unsuccessful
Stop of reference mark search	Indicates whether the reference mark search was canceled Display: <ul style="list-style-type: none"> ■ Yes ■ No

Activating the reference mark search

The product uses the reference marks to reference the machine table to the machine. If the reference mark search has been activated, a wizard appears on startup of the product and asks the user to move the axes for the reference mark search.

Prerequisite: The installed encoders have reference marks that have been configured in the axis parameters.



For encoders with EnDat interface, the reference mark search is omitted because the axes are referenced automatically.



The automatic reference mark search on startup of the product can be canceled depending on the configuration.

Further information: "Reference marks (Encoder)", Page 97



- ▶ Tap **Settings** in the main menu



- ▶ Tap **Axes**
 - ▶ Open in succession:
 - **General settings**
 - **Reference marks**
 - ▶ Activate **Reference mark search after unit start** with the **ON/OFF** slide switch
 - > The reference marks must be traversed every time the product is started.
 - > The functions of the product will only be available after the reference mark search has been completed.
 - > The Reference symbol stops blinking upon successful completion of the reference mark search.
- Further information:** "Operating elements of the position display", Page 40

4.7 Configuring M functions

Depending on the configuration of the machine tool, you can also use M functions (machine functions) for machining operations. You can use M functions to influence the following factors:

- Functions on the machine tool, such as switching the spindle rotation and coolant on and off
- The program execution

You can use all M functions as block type in programming and program run.

Further information: "Machine functions", Page 258

A graphic can also be optionally displayed for calling the M functions in the program run.

Further information: "Configuring M functions", Page 149

The product differentiates between standard M functions and the manufacturer-specific M functions.

4.7.1 Standard M functions

The product supports the following standard M functions (oriented to DIN 66025/ISO 6983):

Code	Description
M2	Program STOP, spindle STOP, coolant OFF
M3	Spindle rotation in clockwise direction
M4	Spindle rotation in counterclockwise direction
M5	Spindle STOP
M8	Coolant ON
M9	Coolant OFF
M30	Program STOP, spindle STOP, coolant OFF

These M functions are independent of the machine; some M functions however depend on the machine tool configuration (e.g. spindle functions).

4.7.2 Manufacturer-specific M functions



The manufacturer-specific M functions M100 to M120 are only available if the connected output has been previously configured.

The product also supports manufacturer-specific M functions with the following characteristics:

- Number range definable from M100 to M120
- Function depends on the machine manufacturer
- Use in the button of the OEM bar

Further information: "Configuring the OEM bar", Page 142

4.8 OEM area

In the **OEM area**, commissioning engineers can customize the product in various ways:

- **Documentation:** Adding the OEM documentation (e.g., service information)
- **Startup screen:** Defining a startup screen with the OEM's company logo
- **OEM bar:** Configuring an OEM bar with specific functions
- **Settings:** Selecting the application, customizing the display elements and messages
- **Screenshots:** Configuring the unit for screenshots with the program ScreenshotClient

4.8.1 Adding documentation

You can store and display the product's documentation right on the product.

i Only documents in the *.pdf file format can be added as a documentation. The product does not display documents provided in other file formats.

Settings ► Service ► OEM area ► Documentation

Parameter	Explanation
Add OEM service info	Selection of the file (file type PDF). The file is copied automatically to the corresponding folder of the product

4.8.2 Adding a startup screen

You can define an OEM-specific startup screen, e.g. the company name or logo, which will be displayed when the product is switched on. An image file with the following properties needs to be stored on the product for this purpose:

- File type: PNG or JPG
- Resolution: 96 ppi
- Image format: 16:10 (other formats will be scaled proportionally)
- Image size: Max. 1280 x 800 px

Settings ► Service ► OEM area ► Startup screen

Parameter	Explanation
Add startup screen	Selecting the image file that is to be displayed as opening screen (file type: PNG or JPG) Further information: "Adding a startup screen", Page 142
Delete startup screen	Delete clears the user-defined opening screen and restores the default view

i When you save the user files, the OEM-specific opening screen is also saved and can be restored.
Further information: "Back up user files", Page 154

4.8.3 Configuring the OEM bar

You can configure the appearance and the menu items of the OEM bar.

i If you configure more menu entries than can be shown in the **OEM bar**, then you can scroll the **OEM bar** vertically.

Settings ► Service ► OEM area ► OEM bar

Parameter	Explanation
Show bar	Display of the OEM bar Settings: <ul style="list-style-type: none"> ■ ON: OEM bar is displayed on the user interface of the respective operating modes ■ OFF: OEM bar is not displayed Default value: OFF
Bar items	Configuration of the Bar items in the OEM bar

Adding bar items

Settings ► Service ► OEM area ► OEM bar ► Bar items ► +

Parameter	Explanation
Description	Description of the bar item on the OEM bar
Type	Selecting the new bar item on the OEM bar Settings: <ul style="list-style-type: none"> ■ Empty ■ Logo ■ Spindle speed ■ M function ■ Special functions ■ Document Default value: Empty
Parameter	The available parameters depend on the type of bar item selected: <ul style="list-style-type: none"> ■ Logo ■ Spindle speed ■ M functions ■ Special functions ■ Document
Remove bar entry	Removing the bar item from the OEM bar

Configuring the OEM logo

You can display an OEM-specific company logo on the OEM bar. By tapping the OEM logo, you can optionally open a PDF file of the OEM documentation.

Settings ► Service ► OEM area ► OEM bar ► Bar items ► Logo

Parameter	Explanation
Description	Description of the bar item on the OEM bar
Type	Logo
Select logo	Selecting the desired image for the depiction
Link to documentation	Using a logo for calling linked documentation Settings: <ul style="list-style-type: none"> ■ None ■ Operating Instructions ■ OEM service info Default value: None
Upload image file	Copies a selected image file to the storage location /Oem/Images <ul style="list-style-type: none"> ■ File format: PNG, JPG, PPM, BMP, or SVG ■ Image size: max. 140 x 70 px
Remove bar entry	Removing the bar item from the OEM bar

Configuring nominal values for the spindle speed

On the OEM bar, you can define menu items that control the spindle speeds depending on the configuration of the machine tool.



You can overwrite configured spindle speeds with the value of the currently set speed of the spindle axis by pressing and holding the desired **Spindle speed** field.

Further information: "Calling functions of the OEM bar", Page 50

Settings ► Service ► OEM area ► OEM bar ► Bar items ► Spindle speed

Parameter	Explanation
Description	Description of the bar item on the OEM bar
Type	Spindle speed
Spindle	S
Spindle speed	Setting the spindle speed <ul style="list-style-type: none"> ■ Setting range: depends on the configuration of the spindle axis S ■ Default value: 0
Remove bar entry	Removing the bar item from the OEM bar

Configuring M functions

On the OEM bar, you can define menu items that control the use of M functions depending on the configuration of the machine tool.

 The manufacturer-specific M functions M100 to M120 are only available if the connected output has been previously configured.

Settings ▶ Service ▶ OEM area ▶ OEM bar ▶ Bar items ▶ M function

Parameter	Explanation
Description	Description of the bar item on the OEM bar
Type	M function
Number of the M function	<p>Selecting the desired M function</p> <p>Setting ranges</p> <ul style="list-style-type: none"> ■ 100.T ... 120.T (TOGGLE: Switches between the states when tapped on the OEM bar) ■ 100.P ... 120.P (PULSE: The length can be set in Pulse time) ■ Default value: Empty
Pulse time	<p>Selecting the length of the high-active pulse</p> <p>Setting range</p> <ul style="list-style-type: none"> ■ 8 ms ... 1500 ms ■ Default value: 500 ms
Restart	<p>Restarting the pulse duration</p> <ul style="list-style-type: none"> ■ Settings: ON or OFF ■ Default value: OFF
Select image for active function	Selecting the desired image for depicting the active function
Select image for inactive function	Selecting the desired image for depicting the inactive function
Upload image file	<p>Copies a selected image file to the storage location /Oem/Images</p> <ul style="list-style-type: none"> ■ File format: PNG, JPG, PPM, BMP, or SVG ■ Image size: Max. 100 x 70 px
Remove bar entry	Removing the bar item from the OEM bar

Configuring special functions

On the OEM bar, you can define menu items that control special functions of the connected machine tool.

 The available functions depend on the configuration of the device and of the connected machine tool.

Settings ► Service ► OEM area ► OEM bar ► Bar items ► Special functions

Parameter	Explanation
Description	Description of the bar item on the OEM bar
Type	Special functions
Function	<p>Selecting the desired special function</p> <p>Settings:</p> <ul style="list-style-type: none"> ■ Thread cutting ■ Spindle direction ■ Coolant ■ Coolant during spindle operation ■ Clamp axes ■ Remove axes from control ■ Zero the tool axis ■ Start central drive <p>Default value: Thread cutting</p>
Direction	<p>Only with Start central drive function:</p> <p>Selecting the traverse direction (positive or negative)</p> <p>If a unipolar motor without direction enabling was assigned to the drive, the direction cannot be set here</p>
Open position control loop	<p>Only with Start central drive function:</p> <p>This parameter ensures that the central drive axes are not put under control, but only a voltage is sent to the output</p> <ul style="list-style-type: none"> ■ Setting range: ON or OFF ■ Default value: OFF
Rotary axis	<p>Only with Start central drive function:</p> <p>This setting defines whether it is a rotary axis</p> <ul style="list-style-type: none"> ■ Setting range: ON or OFF ■ Default value: OFF
Fmax	<p>Only with Start central drive function:</p> <p>This setting defines the maximum speed, which is set in relation to the maximum voltage of the central drive configuration</p> <ul style="list-style-type: none"> ■ Setting range: 100 mm/min ... 10000 mm/min ■ Default value: 100
Start-up time	<p>Only with Start central drive function:</p> <p>Configuration of the acceleration behavior and the braking behavior; time during which the drive accelerates from standstill to maximum feed rate Fmax or decelerates from maximum feed rate to standstill</p> <ul style="list-style-type: none"> ■ Setting range: 100 ms ... 10000 ms ■ Default value: 0

Parameter	Explanation
Select axes	Only with Clamp axes and Remove axes from control function: Select the axes that are to be clamped or removed from closed-loop control Multiple selection is possible
Spindle	Only with Spindle direction function: S
Select image for clockwise spindle direction	Only with Spindle direction function: Selecting the desired image for clockwise spindle rotation
Select image for counterclockwise spindle direction	Only with Spindle direction function: Selecting the desired image for counterclockwise spindle rotation
Select image for active function	Selecting the desired image for depicting the active function
Select image for inactive function	Selecting the desired image for depicting the inactive function
Upload image file	Copies a selected image file to the storage location /Oem/Images <ul style="list-style-type: none"> ■ File format: PNG, JPG, PPM, BMP, or SVG ■ Image size: Max. 100 x 70 px
Remove bar entry	Removing the bar item from the OEM bar

Configuring documents

On the OEM bar, you can define menu items that display additional documents. The file to be displayed needs to be stored in PDF format on the product for this purpose.

Settings ► Service ► OEM area ► OEM bar ► Bar items ► Document

Parameter	Explanation
Description	Description of the bar item on the OEM bar
Type	Document
Select a document	Selecting the desired document
Select image for display	Selecting the desired image for depicting the function
Upload image file	Copies a selected image file to the storage location /Oem/Images
Remove bar entry	Removing the bar item from the OEM bar

4.8.4 Adjusting the display

You can adjust the override display in the **Manual operation** and **MDI** menus. You can also define the layout of the screen keyboard.

Adjusting the Override display

Settings ► Service ► OEM area ► Settings

Parameter	Explanation
Override display	Type of override display in Manual operation and MDI mode Settings: <ul style="list-style-type: none"> ■ Percent: The override is displayed as a percentage of the set maximum feed rate ■ Value: Override is displayed in mm/min Default value: Percent

Defining the keyboard design

Settings ► Service ► OEM area ► Settings

Parameter	Explanation
Keyboard theme	Selection of the keyboard layout Settings: <ul style="list-style-type: none"> ■ Standard: Entry confirmed with (Return) ■ TNC: Entry confirmed with (Enter) Default value: Standard

4.8.5 Adjusting the program execution

As an OEM you can configure the mode of program execution. For example, you can configure M functions. If you are using a central drive, you can change the default image for the central drive.

Program execution

Settings ► Service ► OEM area ► Settings ► Program run

Parameter	Explanation
Use rapid traverse key to ignore programmed feed rate	The set or programmed feed rate is ignored in the MDI or Program Run operating modes when the rapid traverse key is pressed <ul style="list-style-type: none"> ■ Settings: ON or OFF ■ Default value: OFF
Automatic advance on reaching upper spindle sleeve final position	Automatic advance when executing hole patterns always occurs when the upper spindle sleeve limit switch is reached <ul style="list-style-type: none"> ■ Settings: ON or OFF ■ Default value: OFF
M functions	For the configuration, see "Configuring M functions", Page 149
Central drive	Assigning an image that is displayed during the execution of a program run block for setting the axis direction; see "Configuring the central drive", Page 149

Configuring M functions

Settings ► Service ► OEM area ► Settings ► Program run ► M functions

Parameter	Explanation
Number of the M function	<p>Enter the number of the new M function</p> <ul style="list-style-type: none"> ■ Setting range: M2.0 ... M120.0 (0: The output assigned to the M function is switched to inactive) ■ Setting range: M2.1 ... M120.1 (1: The output assigned to the M function is switched to active) ■ Setting range: M2.2 ... M120.2 (2: The output assigned to the M function generates a high active pulse of 8 ms)
Automatic run	<p>Setting for whether an M function is executed automatically during program run or if a message must be acknowledged.</p> <ul style="list-style-type: none"> ■ Settings: ON or OFF ■ Default setting: OFF Execution requires acknowledgment ■ ON Execution does not require acknowledgment
Select image for dialog during program run	Select the desired image for display during program run
Upload image file	<p>Copies a selected image file to the storage location /Oem/Images</p> <ul style="list-style-type: none"> ■ File format: PNG, JPG, PPM, BMP, or SVG ■ Image size: Max. 160 x 160 px
Help text ID or help text for programming	<p>Selection of the text to be shown. You can enter a Text-ID and thus select a text that is available in your text database. As an alternative, you can directly enter a new text</p> <div style="border: 1px solid black; padding: 5px; margin-top: 10px;"> <p> If you change the user language of the product, the translations of the texts from the text database are used. For directly entered texts, no translation is shown.</p> </div> <p>Further information: "Creating a Text database", Page 150</p>
Remove the entry	Remove the entry

Configuring the central drive

Settings ► Service ► OEM area ► Settings ► Program run ► Central drive

Parameter	Explanation
Axis	<p>Axis name</p> <ul style="list-style-type: none"> ■ Setting range: e.g. X, X+, X- <p>Only axes that have already been configured can be selected.</p>
Select image for dialog during program run	Select the desired image for display during program run
Upload image file	<p>Copies a selected image file to the storage location /Oem/Images</p> <ul style="list-style-type: none"> ■ File format: PNG, JPG, PPM, BMP, or SVG ■ Image size: Max. 160 x 160 px
Remove the entry	Removing the entry

4.8.6 Defining error messages

As an OEM, you can define specific error messages that either overwrite default error messages or are triggered as additional messages through defined input signals. For this purpose you can create a text database containing your specific error messages.

Creating a Text database

The device features the option of importing your own text database. The **Messages** parameter allows you to show various messages.

To create a text database containing the OEM-specific error messages, you create a file of the *.xml type and add your entries for the individual message texts to this file.

The XML file must be in UTF-8 format. The following figure shows the correct structure of the XML file:

```

1  <?xml version="1.0" encoding="UTF-8"?>
2  <source version="1">
3    <entry id="ID_OEM_EMERGENCY_STOP">
4      <text lang="de">Der Not-Aus ist aktiv.</text>
5      <text lang="cs">Nouzové zastavení je aktivní.</text>
6      <text lang="en">The emergency stop is active.</text>
7      <text lang="fr">L'arrêt d'urgence est actif.</text>
8      <text lang="it">L'arresto d'emergenza è attivo.</text>
9      <text lang="es">La parada de emergencia está activa.</text>
10     <text lang="ja">緊急停止がアクティブです.</text>
11     <text lang="pl">Wyłączenie awaryjne jest aktywne.</text>
12     <text lang="pt">O desligamento de emergência está ativo.</text>
13     <text lang="ru">Активен аварийный останов.</text>
14     <text lang="zh">急停激活.</text>
15     <text lang="zh-tw">緊急停止啟動.</text>
16     <text lang="ko">비상 정지가 작동 중입니다.</text>
17     <text lang="tr">Acil kapatma etkin.</text>
18     <text lang="nl">De noodstop is actief.</text>
19   </entry>
20   <entry id="ID_OEM_CONTROL_VOLTAGE">
21     <text lang="de">Es liegt keine Steuerspannung an.</text>
22     <text lang="cs">Není použito žádné řídicí napětí.</text>
23     <text lang="en">No machine control voltage is being applied.</text>
24     <text lang="fr">Aucune tension de commande n'est appliquée.</text>
25     <text lang="it">Non è applicata alcuna tensione di comando.</text>
26     <text lang="es">No está aplicada la tensión de control.</text>
27     <text lang="ja">御電圧は適用されていません.</text>
28     <text lang="pl">Brak zasilania sterowania.</text>
29     <text lang="pt">Não existe tensão de comando.</text>
30     <text lang="ru">Управляющее напряжение отсутствует.</text>
31     <text lang="zh">无控制电压.</text>
32     <text lang="zh-tw">並無供應控制電壓.</text>
33     <text lang="ko">공급된 제어 전압이 없습니다.</text>
34     <text lang="tr">Kumanda gerilimi mevcut değil.</text>
35     <text lang="nl">Er is geen sprake van stuurspanning.</text>
36   </entry>
37 </source>

```

Figure 24: Example – XML file for text database

Then you import the XML file by means of a USB mass storage device (FAT32 format) and save it, for example, to **Internal/Oem**.

Settings ► Service ► OEM area ► Settings ► Text database

Parameter	Explanation
Select text database	Selecting an XML type text database stored in the device Further information: "Creating a Text database", Page 150
Deselect text database	Deselecting the currently selected text database

Configuring error messages

The OEM-specific error messages can be gated to inputs as additional messages. The error messages will then be displayed when the input is activated. For this to work, you need to assign the error messages to the desired input signals.

Settings ► Service ► OEM area ► Settings ► Messages

Parameter	Explanation
Name	Description of the message
Text ID or text	<p>Selecting the message to be displayed. You can enter a Text ID and thus select a message text that is available in your text database. As an alternative, you can directly enter a new message text</p> <div style="border: 1px solid black; padding: 5px; margin-top: 10px;"> <p>i If you change the user language of the device, the translations of the message texts from the text database are used. For directly entered texts, no translation is shown.</p> </div> <p>Further information: "Creating a Text database ", Page 150</p>
Message type	<p>Selecting the desired type of message</p> <p>Settings:</p> <ul style="list-style-type: none"> ■ Standard: The message is displayed as long as the input is active ■ Acknowledgment by user: The message is displayed until the user acknowledges it ■ Default value: Standard
Input	<p>Assignment of the digital input according to pin layout to show the message</p> <ul style="list-style-type: none"> ■ Default value: Not connected
Remove the entry	Removing the message entry

4.8.7 Backing up and restoring OEM settings

All settings of the OEM area can be backed up as a file so that they are available after a reset to the factory default settings has been performed or for installation on multiple units.

The settings for the OEM area can be backed up as a ZIP file on a USB mass storage device or connected network drive.

Settings ► Service ► OEM area ► Back up and restore

Parameter	Explanation
Back-up OEM-specific folders and files	Backing up the settings of the OEM area as a ZIP file
Restore OEM specific folders and files	Restoring the settings of the OEM area as a ZIP file

4.8.8 Configuring the unit for screenshots

ScreenshotClient

With the ScreenshotClient PC software, you can use a computer to take screenshots of the active screen of the product.

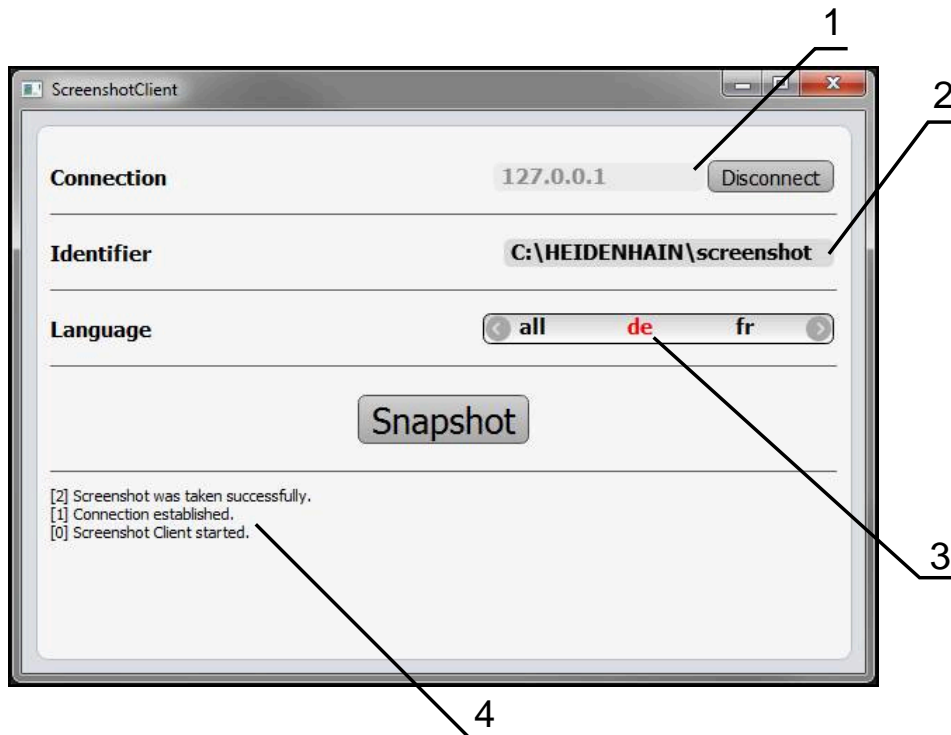

Figure 25: The ScreenshotClient user interface

- 1 Connection status
- 2 File path and file name
- 3 Language selection
- 4 Status messages

i ScreenshotClient is included in the standard installation of **POSITIP 8000 Demo**.

M For a detailed description, please refer to the **POSITIP 8000 Demo User's Manual**.

- ▶ <https://www.heidenhain.com/service/downloads/software>
- ▶ Select a category
- ▶ Select the product family
- ▶ Select the desired language

Further information: "Demo software for the product", Page 9

Activating remote access for screenshots

To connect ScreenshotClient with the product via the computer you need to activate **Remote access for screenshots** on the product.

Settings ▶ Service ▶ OEM area

Parameter	Explanation
Remote access for screenshots	<p>Permitting a network connection with the ScreenshotClient program so that ScreenshotClient can take screenshots of the unit from a computer</p> <p>Settings:</p> <ul style="list-style-type: none"> ■ ON: Remote access is possible ■ OFF: Remote access is not possible ■ Default value: OFF



When the unit is shut down, **Remote access for screenshots** is automatically deactivated.

4.9 Backing up data

4.9.1 Back up settings

The product's settings can be backed up as a file so that they are available after a reset to the factory default settings has been performed or for installation on multiple units.

Settings ▶ Service ▶ Back up and restore

Parameter	Explanation
Back up settings	Backing up of settings of the product

Performing a Complete backup

During a complete backup of the configuration, all settings of the product are backed up.

- ▶ Tap **Complete backup**
- ▶ If required, connect a USB mass storage device (FAT32 format) to a USB port of the product
- ▶ Select the folder to which you want to copy the configuration data
- ▶ Specify a name for the configuration data, e.g. "<yyyy-mm-dd>_config"
- ▶ Confirm the entry with **RET**
- ▶ Tap **Save as**
- ▶ Tap **OK** to confirm the successful backup of the configuration
- > The configuration file has been backed up.

Safely removing a USB mass storage device



- ▶ Tap **File management** in the main menu
- ▶ Navigate to the list of storage locations



- ▶ Tap **Safely remove**
- > The message **The storage medium can be removed now.** appears.
- ▶ Disconnect the USB mass storage device

4.9.2 Back up user files

The user files of the product can be backed up as a file so that they are available after a reset to the factory default settings. In conjunction with the backup of the settings, the complete configuration of a product can be backed up.



All files from all user groups that are stored in the respective folders are backed up and can be restored as user files.
The files in the **System** folder are not restored.

Settings ▶ Service ▶ Back up and restore

Parameter	Explanation
Back up user files	Backing up of user files of the product

Performing back up

The user files can be backed up as a ZIP file on a USB mass storage device or connected network drive.

- ▶ Open in succession:
 - **Back up and restore**
 - **Back up user files**
- ▶ Tap **Save as ZIP**
- ▶ If required, connect a USB mass storage device (FAT32 format) to a USB port of the product
- ▶ Select the folder to which you want to copy the ZIP file
- ▶ Enter a name for the ZIP file (e.g., "<yyyy-mm-dd>_config")
- ▶ Confirm the entry with **RET**
- ▶ Tap **Save as**
- ▶ Tap **OK** to confirm successful backup of the user files
- > The user files were backed-up.

Safely removing a USB mass storage device



- ▶ Tap **File management** in the main menu
- ▶ Navigate to the list of storage locations



- ▶ Tap **Safely remove**
- > The message **The storage medium can be removed now.** appears.
- ▶ Disconnect the USB mass storage device

5

Setup

5.1 Overview

This chapter contains all the information necessary for setting up the product.

During setup, the setup engineer (**Setup**) configures the product for use on the machine tool in the respective applications. This includes, for example, setting up operators and creating preset tables and tool tables.



Make sure that you have read and understood the "Basic Operation" chapter before carrying out the actions described below.

Further information: "Basic Operation", Page 19



The following steps must be performed only by qualified personnel.

Further information: "Personnel qualification", Page 16

5.2 Logging in for setup

5.2.1 User login

To set up the product, the **Setup** user must log in.



- ▶ Tap **User login** in the main menu
- ▶ If required, log out the user who is currently logged in
- ▶ Select the **Setup** user
- ▶ Tap the **Password** input field
- ▶ Enter the password "**setup**"



If a password other than the default password has been assigned to the user, ask a **Setup** or **OEM** user for the assigned password.

If the password is no longer known, contact a HEIDENHAIN service agency.

- ▶ Confirm the entry with **RET**
- ▶ Tap **Log in**



5.2.2 Performing the reference mark search after startup

 If the product is configured with a **spindle axis S**, then you must define an upper limit for the spindle speed prior to a possible machining operation.
Further information: "Defining the upper limit for the spindle speed", Page 227

 If the reference mark search after unit start is active, then all of the unit's functions will be disabled until the reference mark search has been successfully completed.
Further information: "Reference marks (Encoder)", Page 97

 For encoders with EnDat interface, the reference mark search is omitted because the axes are referenced automatically.

If the reference mark search is active on the unit, then a wizard will ask you to traverse the reference marks of the axes.

- ▶ After logging in, follow the instructions of the wizard
- > The Reference symbol stops blinking upon successful completion of the reference mark search.

Further information: "Operating elements of the position display", Page 40

Further information: "Activating the reference mark search", Page 140

5.2.3 Setting the language

The user interface language is English. You can change to another language, if desired.



- ▶ Tap **Settings** in the main menu



- ▶ Tap **User**
- > The logged-in user is indicated by a check mark.
- ▶ Select the logged-in user
- > The language selected for the user is indicated by a national flag in the **Language** drop-down list.
- ▶ Select the flag for the desired language from the **Language** drop-down list
- > The user interface is displayed in the selected language.

5.2.4 Changing the password

You must change the password to prevent unauthorized configuration.

The password is confidential and must not be disclosed to any other person.



- ▶ Tap **Settings** in the main menu



- ▶ Tap **User**
 - > The logged-in user is indicated by a check mark.
 - ▶ Select the logged-in user
 - ▶ Tap **Password**
 - ▶ Enter the current password
 - ▶ Confirm entry with **RET**
 - ▶ Enter the new password and repeat it
 - ▶ Confirm entry with **RET**
 - ▶ Tap **OK**
 - ▶ Close the message with **OK**
 - > The new password is available the next time the user logs in.

5.3 Single steps for setup

i The following setup steps build on each other.

- ▶ To correctly set up the product, make sure to perform the steps in the order described here

Prerequisite: You are logged on as a user of the **Setup** type (see "Logging in for setup", Page 156).

Basic settings

- Setting the date and time
- Setting the units of measure
- Entering and configuring users
- Adding the Operating Instructions
- Configuring the network
- Configuring the network drive
- Configuring operation with a mouse or touchscreen

Preparing machining processes

- Creating a tool table
- Creating a preset table

Backing up data

- Back up settings
- Back up user files

NOTICE

Loss of or damage to configuration data!

If the product is disconnected from the power source while it is on, the configuration data can be lost or corrupted.

- ▶ Back up the configuration data and keep the backup for recovery purposes

5.3.1 Basic settings

i The commissioning engineer (**OEM**) may have already carried out several basic settings.

Setting the date and time

Settings ► General ► Date and time

Parameter	Explanation
Date and time	Current date and time of the product <ul style="list-style-type: none"> Settings: Year, Month, Day, Hour, Minute Default setting: Current system time
Date format	Format in which the date is displayed Settings: <ul style="list-style-type: none"> MM-DD-YYYY: Month, day, year DD-MM-YYYY: Day, month, year YYYY-MM-DD: Year, month, day Default setting: YYYY-MM-DD (e.g. "2016-01-31")

Setting the units of measure

You can set various parameters to define the units of measure, rounding methods and decimal places.

Settings ► General ► Units

Parameter	Explanation
Unit for linear values	Unit of measure for linear values <ul style="list-style-type: none"> Settings: Millimeters or Inch Default setting: Millimeters
Rounding method for linear values	Rounding method for linear values Settings: <ul style="list-style-type: none"> Commercial: Decimal places from 1 to 4 are rounded down, decimal places from 5 to 9 are rounded up Round off: Decimal places from 1 to 9 are rounded down Round up: Decimal places from 1 to 9 are rounded up Truncate: Decimal places are truncated without rounding up or down Round to 0 and 5: Decimal places ≤ 24 or ≥ 75 are rounded to 0, decimal places ≥ 25 or ≤ 74 are rounded to 5 Default setting: Commercial
Decimal places for linear values	Number of decimal places for linear values Setting range: <ul style="list-style-type: none"> Millimeters: 0 ... 5 Inch: 0 ... 7 Default value: <ul style="list-style-type: none"> Millimeters: 4 Inch: 6
Unit for angular values	Unit for angular values Settings: <ul style="list-style-type: none"> Radian: Angles in radian (rad) Decimal degrees: Angles in degrees (°) with decimal places Deg-Min-Sec: Angles in degrees (°), minutes ['] and seconds ["] Default setting: Decimal degrees

Parameter	Explanation
Rounding method for angular values	<p>Rounding method for decimal angular values</p> <p>Settings:</p> <ul style="list-style-type: none"> ■ Commercial: Decimal places from 1 to 4 are rounded down, decimal places from 5 to 9 are rounded up ■ Round off: Decimal places from 1 to 9 are rounded down ■ Round up: Decimal places from 1 to 9 are rounded up ■ Truncate: Decimal places are truncated without rounding up or down ■ Round to 0 and 5: Decimal places ≤ 24 or ≥ 75 are rounded to 0, decimal places ≥ 25 or ≤ 74 are rounded to 5 ■ Default setting: Commercial
Decimal places for angular values	<p>Number of decimal places for angular values</p> <p>Setting range:</p> <ul style="list-style-type: none"> ■ Radian: 0 ... 7 ■ Decimal degrees: 0 ... 5 ■ Deg-Min-Sec: 0 ... 2 <p>Default value:</p> <ul style="list-style-type: none"> ■ Radian: 5 ■ Decimal degrees: 3 ■ Deg-Min-Sec: 0
Decimal separator	<p>Separator for the display of values</p> <ul style="list-style-type: none"> ■ Settings: Point or Comma ■ Default setting: Point

Entering and configuring users

The following user types, which have different rights, are defined in the product's factory default settings:

- **OEM**
- **Setup**
- **Operator**

Creating a user and password

You can create new **Operator** users. You can use any characters for the user ID and the password. These entries are case-sensitive.

Prerequisite: An **OEM** or **Setup** user is logged in.

 It is not possible to create new **OEM** or **Setup**-type users.

Settings ► User ► +

Parameter	Explanation
	Adds a new user of the Operator type It is not possible to add further OEM and Setup users.
User ID	The User ID is displayed for user selection, e.g., at the login prompt. The User ID cannot be changed once it has been defined.
Name	Name of the user
Password	Entering a password for login
Repeat password	Repeating the password
Show password	You can show the contents of the password fields in plain text and hide them again.

Configuring and deleting a user

Settings ► User ► User name

Parameter	Explanation
Name	Name of the user
First name	First name of the user
Department	Department of the user
Group	Stating the group to which the user belongs
Password	The password can be changed.
Language	Selecting the language to be displayed for the user
Auto login	Selecting whether the user is to be logged on automatically without entering a password. The user must have been logged on before the device is switched off.

 If automatic user login is active for one or more users, the last user who logged in is automatically logged in when the product is switched on. Neither the user ID nor the password needs to be entered.

Remove user account The user can be removed by an OEM user or Setup user.

 **OEM** and **Setup**-type users cannot be deleted.

Adding the Operating Instructions

The product provides the possibility to upload the corresponding Operating Instructions in the desired language. The Operating Instructions can be copied from the supplied USB mass storage device to the product.

The latest version can be downloaded from the download area at www.heidenhain.com.

Settings ► Service ► Documentation

Parameter	Explanation
Add Operating Instructions	Adding the Operating Instructions in the desired language

Configuring the network

Network settings



Contact your network administrator for the correct network settings for configuring the product.

Settings ► Interfaces ► Network ► X116

Parameter	Explanation
MAC address	Unique hardware address of the network adapter
DHCP	Dynamically assigned network address of the product <ul style="list-style-type: none"> ■ Settings: ON or OFF ■ Default value: ON
IPv4 address	Network address consisting of four octets The network address is automatically assigned if DHCP is active, or it can be entered manually <ul style="list-style-type: none"> ■ Setting range: 0.0.0.1 ... 255.255.255.255
IPv4 subnet mask	Identifier within the network, consisting of four octets The subnet mask is automatically assigned if DHCP is active, or it can be entered manually. <ul style="list-style-type: none"> ■ Setting range: 0.0.0.0 ... 255.255.255.255
IPv4 standard gateway	Network address of the router connecting a network <div style="border: 1px solid black; padding: 5px; margin-top: 10px;"> <p> The network address is automatically assigned if DHCP is active, or it can be entered manually.</p> </div> <ul style="list-style-type: none"> ■ Setting range: 0.0.0.1 ... 255.255.255.255
IPv6 SLAAC	Network address with extended namespace Only required if supported in the network <ul style="list-style-type: none"> ■ Settings: ON or OFF ■ Default value: OFF
IPv6 address	Automatically assigned if IPv6 SLAAC is active
IPv6 subnet prefix length	Subnet prefix in IPv6 networks
IPv6 standard gateway	Network address of the router connecting a network
Preferred DNS server	Primary server for mapping the IP address
Alternative DNS server	Optional server for mapping the IP address

Configuring the network drive

You will need the following data for configuring the network drive:

- **Name**
- **Server IP address or host name**
- **Shared folder**
- **User name**
- **Password**
- **Network drive options**

Further information: "Connecting a network peripheral", Page 79

 Contact your network administrator for the correct network settings for configuring the product.

Settings ► Interfaces ► Network drive

Parameter	Explanation
Name	Folder name displayed in the file management Default value: Share (cannot be changed)
Server IP address or host name	Name or network address of the server
Shared folder	Name of the shared folder
User name	Name of the authorized user
Password	Password of the authorized user
Show password	Display of the password in plain text <ul style="list-style-type: none"> ■ Settings: ON or OFF ■ Default value: OFF
Network drive options	Configuration of the Authentication for encrypting the password in the network Settings: <ul style="list-style-type: none"> ■ None ■ Kerberos V5 authentication ■ Kerberos V5 authentication and packet signing ■ NTLM password hashing ■ NTLM password hashing with signing ■ NTLMv2 password hashing ■ NTLMv2 password hashing with signing ■ Default value: None Configuration of the Mount options Settings: <ul style="list-style-type: none"> ■ Default value: nounix,noserverino

Configuring operation with a mouse or touchscreen

The product can be operated either via the touchscreen or a connected (USB) mouse. If the product is in its factory default setting, touching the touchscreen deactivates the mouse. Alternatively, you can set that the product is operated either only via the mouse or only via the touchscreen.

Prerequisite: A USB mouse is connected to the product.

Further information: "Connecting input devices", Page 79

You can modify the touch sensitivity of the touchscreen to allow operation under special conditions (e.g. for operation with gloves).

Settings ► General ► Input devices

Parameter	Explanation
Touchscreen sensitivity	<p>The sensitivity of the touchscreen can be adjusted in three levels</p> <ul style="list-style-type: none"> ■ Low (contamination): Allows operating the touchscreen if it is dirty ■ Normal (standard): Allows operating the touchscreen under normal conditions ■ High (gloves): Allows operating the touchscreen while wearing gloves ■ Default setting: Normal (standard)
Mouse substitute for multitouch gestures	<p>Specifies whether mouse operation should replace operation using the touchscreen (multitouch)</p> <p>Settings:</p> <ul style="list-style-type: none"> ■ Auto (until first multitouch): Touching the touchscreen causes mouse deactivation ■ On (no multitouch): Operation only possible with the mouse, the touchscreen is deactivated ■ Off (only multitouch): Operation only possible with the touchscreen, the mouse is deactivated ■ Default setting: Auto (until first multitouch)
USB keyboard layout	<p>If a USB keyboard is connected:</p> <ul style="list-style-type: none"> ■ Language selection of the keyboard assignment

5.3.2 Preparing machining processes

Depending on the intended use, the machine setter (**Setup**) can prepare the unit for a special machining process through configuration of the tool tables and preset tables.

i The following activities can also be performed by **Operator**-type users.

Creating a tool table

You usually enter the coordinates in accordance with how the workpiece is dimensioned in the drawing.

You must specify the **X** tool coordinate and the **Z** tool coordinate of the turning tool to be used. The **Set tool data** function allows you to calibrate your tools directly on the lathe.

From the status bar, you can access the tool table, which contains these specific parameters for each tool that is used. You can save a maximum of 99 tools in the tool table.

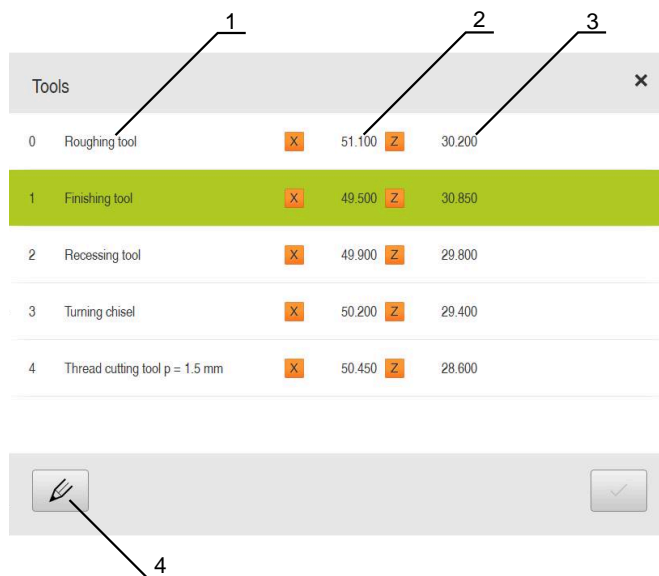

- 1 Tool type
- 2 Tool diameter
- 3 Tool length
- 4 Edit tool table

Tool parameters

You can define the following parameters:

Description	Parameter	
Tool type	X tool coordinate	Z tool coordinate
Designation that uniquely identifies the tool	Tip of the tool cutting edge in the Z axis	Tip of the tool cutting edge in the X axis

Creating a tool



- ▶ Tap **Tools** on the status bar
- > The **Tools** dialog box appears.



- ▶ Tap **Open table**
- > The **Tool table** dialog box appears.



- ▶ Tap **Add**
- ▶ Enter a name in the **Tool type** input field
- ▶ Confirm the entry with **RET**
- ▶ Tap the input fields one after the other, and enter the corresponding values
- ▶ Change the unit of measure in the selection menu, if required
- > The entered values are converted.
- ▶ Confirm the entry with **RET**
- > The defined tool is added to the tool table.



- ▶ To protect the entry for a tool from accidental changes or deletion, tap the **Lock** symbol next to the tool's entry



- > The icon changes and the entry is locked.



- ▶ Tap **Close**
- > The **Tool table** dialog is closed.

Calibrating a tool



- ▶ Tap **Manual operation** in the main menu
- > The user interface for Manual operation appears.



- ▶ Tap **Auxiliary functions** in the status bar



- ▶ Tap **Tool data** in the dialog box
- > The **Set tool data** dialog box opens.
- ▶ Move the tool to the desired position



- ▶ Tap **Save position**
- > The current position of the tool is saved.
- ▶ Retract the tool to a safe position



- ▶ Enter the desired position data in the input fields
- ▶ Tap **Confirm** in the wizard
- > The **Select the tool** dialog box appears.
- ▶ Select the desired tool in the **Selected tool** input field:
 - ▶ To overwrite an existing tool, select an entry from the tool table
 - ▶ To add a new tool, enter a number that has not yet been assigned in the tool table and confirm by pressing **RET**



- ▶ Tap **Confirm** in the wizard
- > The probed coordinates are adopted for the tool.

Deleting a tool



- ▶ Tap **Tools** on the status bar
- > The **Tools** dialog box appears.



- ▶ Tap **Open table**
- > The **Tool table** dialog box appears.
- ▶ To select one or more tools, tap the checkbox in the relevant row
- > The active checkbox is highlighted in green.



The entry for a tool can be locked to prevent accidental changes or deletion.

- ▶ Tap the **Unlock** symbol next to the entry
- > The symbol changes and the entry is unlocked.



- ▶ Tap **Delete**
- > A message appears.
- ▶ Close the message with **OK**
- > The selected tool is deleted from the tool table.



- ▶ Tap **Close**
- > The **Tool table** dialog is closed.

Creating a preset table

You can access the preset table on the status bar. The preset table contains the absolute positions of the presets with respect to the reference mark. You can save a maximum of 99 presets in the preset table.



- 1 Designation
- 2 Coordinates
- 3 Edit the preset table

Defining presets

You can define the preset table in the following ways:

Designation	Description
Touch-off	Probing a workpiece using a tool. You must define the respective tool position manually as a preset
Numerical input	You must manually enter the numeric value of the preset into the preset table

 Depending on the application, users of the type **Operator** define the presets.

Touching off presets



- ▶ Tap **Manual operation** in the main menu
- > The user interface for Manual operation appears.



- ▶ Tap **Auxiliary functions** in the status bar



- ▶ Tap **Presets** in the dialog box
- > The **Set preset data** dialog box opens.
- ▶ Move the tool to the desired position



- ▶ Tap **Save position**
- > The current position of the tool is saved.
- ▶ Retract the tool to a safe position



- ▶ Enter the desired position data in the input fields
- ▶ Tap **Confirm** in the wizard
- > The dialog Select preset opens.
- ▶ Select the desired preset in the **Selected preset** input field:
 - ▶ To overwrite an existing preset, select an entry from the preset table
 - ▶ To create a new preset, enter a number that has not yet been assigned in the preset table and confirm with **RET**



- ▶ Tap **Confirm** in the wizard
- > The probed coordinates are adopted as the preset.

5.4 Back up settings

The product's settings can be backed up as a file so that they are available after a reset to the factory default settings has been performed or for installation on multiple units.

Settings ▶ Service ▶ Back up and restore

Parameter	Explanation
Back up settings	Backing up of settings of the product

Performing a Complete backup

During a complete backup of the configuration, all settings of the product are backed up.

- ▶ Tap **Complete backup**
- ▶ If required, connect a USB mass storage device (FAT32 format) to a USB port of the product
- ▶ Select the folder to which you want to copy the configuration data
- ▶ Specify a name for the configuration data, e.g. "<yyyy-mm-dd>_config"
- ▶ Confirm the entry with **RET**
- ▶ Tap **Save as**
- ▶ Tap **OK** to confirm the successful backup of the configuration
- > The configuration file has been backed up.

Safely removing a USB mass storage device



- ▶ Tap **File management** in the main menu
- ▶ Navigate to the list of storage locations
- ▶ Tap **Safely remove**
- > The message **The storage medium can be removed now.** appears.
- ▶ Disconnect the USB mass storage device

5.5 Back up user files

The user files of the product can be backed up as a file so that they are available after a reset to the factory default settings. In conjunction with the backup of the settings, the complete configuration of a product can be backed up.



All files from all user groups that are stored in the respective folders are backed up and can be restored as user files.
The files in the **System** folder are not restored.

Settings ► Service ► Back up and restore

Parameter	Explanation
Back up user files	Backing up of user files of the product

Performing back up

The user files can be backed up as a ZIP file on a USB mass storage device or connected network drive.

- ▶ Open in succession:
 - **Back up and restore**
 - **Back up user files**
- ▶ Tap **Save as ZIP**
- ▶ If required, connect a USB mass storage device (FAT32 format) to a USB port of the product
- ▶ Select the folder to which you want to copy the ZIP file
- ▶ Enter a name for the ZIP file (e.g., "<yyy-mm-dd>_config")
- ▶ Confirm the entry with **RET**
- ▶ Tap **Save as**
- ▶ Tap **OK** to confirm successful backup of the user files
- > The user files were backed-up.

Safely removing a USB mass storage device



- ▶ Tap **File management** in the main menu
- ▶ Navigate to the list of storage locations
- ▶ Tap **Safely remove**
- > The message **The storage medium can be removed now.** appears.
- ▶ Disconnect the USB mass storage device

6

File Management

6.1 Overview

This chapter describes the **File management** menu and its functions.

i Make sure that you have read and understood the "Basic Operation" chapter before carrying out the actions described below.
Further information: "Basic Operation", Page 19

Short description

The **File management** menu shows an overview of the files stored in the product's memory.

Any connected USB mass storage devices (FAT32 format) or available network drives are shown in the list of storage locations. The USB mass storage devices and the network drives are displayed with their name or drive designation.

Call



- ▶ Tap **File management** in the main menu
- > The file management user interface is displayed.

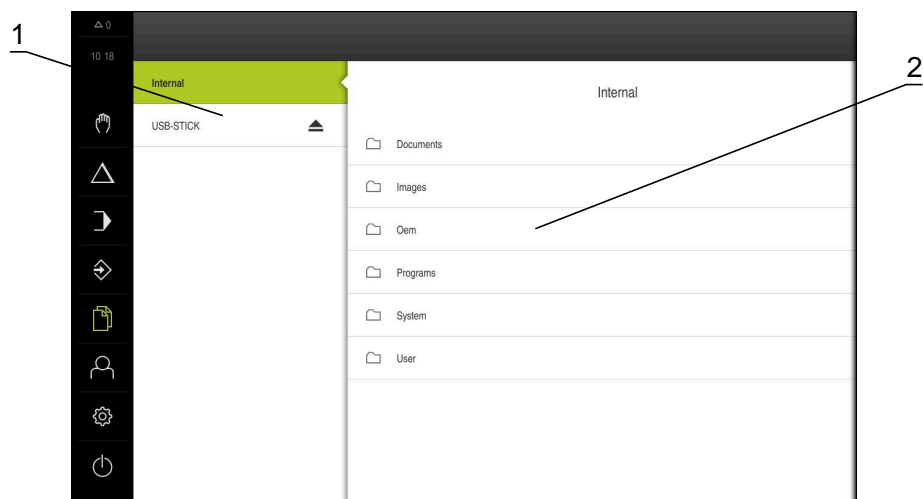

Figure 26: **File management** menu

- 1 List of available storage locations
- 2 List of folders in the selected storage location

6.2 File types

In the **File management** menu you can edit the following file types:

Type	Use	Manage	View	Open	Print
*.i	Programs	✓	–	–	–
*.mcc	Configuration files	✓	–	–	–
*.dro	Firmware files	✓	–	–	–
*.svg, *.ppm	Image files	✓	–	–	–
*.jpg, *.png, *.bmp	Image files	✓	✓	–	–
*.csv	Text files	✓	–	–	–
*.txt, *.log, *.xml	Text files	✓	✓	–	–
*.pdf	PDF files	✓	✓	–	✓





6.3 Managing folders and files



Folder structure

In the **File management** menu, the files in the **Internal** storage location are saved in the following folders:

Folders	Application
Documents	Document files
Images	Image files
Oem	Files for configuring the OEM bar (visible only to OEM users)
System	Audio files and system files
User	User data

Operating element	Function
	<p>Creating a new folder</p> <ul style="list-style-type: none"> ▶ Touch the icon of the folder in which you want to create a new folder, and drag it to the right > The operating elements are displayed. ▶ Tap Create a new folder ▶ Tap the input field in the dialog box and enter a name for the new folder ▶ Confirm your input with RET ▶ Tap OK > A new folder is created.

Operating element	Function
	<p>Moving a folder</p> <ul style="list-style-type: none"> ▶ Touch the icon of the folder you want to move, and drag it to the right > The operating elements are displayed. ▶ Tap Move to ▶ In the dialog box, select the folder to which you want to move the folder ▶ Tap Select > The folder is moved.
	<p>Copying a folder</p> <ul style="list-style-type: none"> ▶ Touch the icon of the folder you want to copy, and drag it to the right > The operating elements are displayed. ▶ Tap Copy to ▶ In the dialog box, select the folder to which you want to copy the folder ▶ Tap Select > The folder is copied.
	<p>Renaming a folder</p> <ul style="list-style-type: none"> ▶ Touch the icon of the folder you want to rename, and drag it to the right > The operating elements are displayed. ▶ Tap Rename folder ▶ Tap the input field in the dialog box and enter a name for the new folder ▶ Confirm your input with RET ▶ Tap OK > The folder is renamed.
	<p>Moving a file</p> <ul style="list-style-type: none"> ▶ Touch the icon of the file you want to move, and drag it to the right > The operating elements are displayed. ▶ Tap Move to ▶ In the dialog box, select the folder to which you want to move the file ▶ Tap Select > The file is moved.
<p> If you move a file into a folder containing a file with the same name, that file is overwritten.</p>	

Operating element	Function
	<p>Copying a file</p> <ul style="list-style-type: none"> ▶ Touch the icon of the file you want to copy, and drag it to the right > The operating elements are displayed. ▶ Tap Copy to ▶ In the dialog box, select the folder to which you want to copy the file ▶ Tap Select > The file is copied.
	<p>Renaming a file</p> <ul style="list-style-type: none"> ▶ Touch the icon of the file you want to rename, and drag it to the right > The operating elements are displayed. ▶ Tap Rename file ▶ Tap the input field in the dialog box and enter a name for the new file ▶ Confirm your input with RET ▶ Tap OK > The file is renamed.
	<p>Deleting a folder or file</p> <p>The folders and files you delete will be permanently deleted and cannot be recovered. If you delete a folder, all subfolders and files contained in that folder will also be deleted.</p> <ul style="list-style-type: none"> ▶ Touch the icon of the folder or file you want to delete, and drag it to the right > The operating elements are displayed. ▶ Tap Delete selection ▶ Tap Delete > The folder or file is deleted.

6.4 Viewing files

Viewing files



- ▶ Tap **File management** in the main menu
- ▶ Navigate to the storage location of the desired file
- ▶ Tap the file
- A preview image (only with PDF and image files) as well as information about the file are displayed.

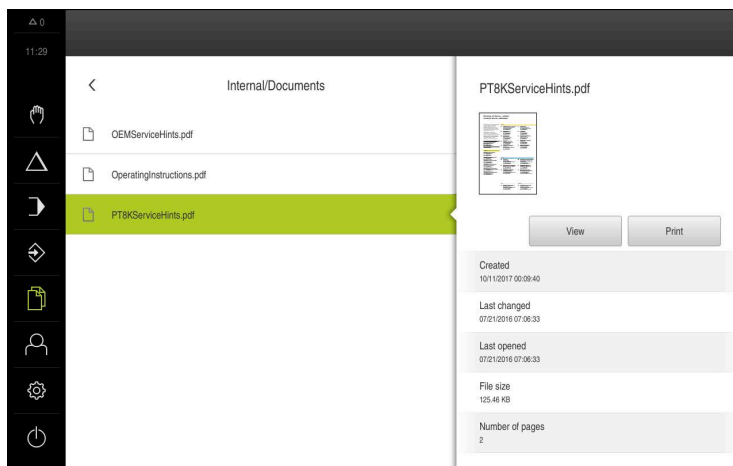

Figure 27: **File management** menu with preview image and file information

- ▶ Tap **View**
- The file contents are displayed.
- ▶ Tap **Close** to close the view



6.5 Exporting files

You can export files to an external USB mass storage device (FAT32 format) or to the network drive. You can either copy or move the files:

- If you copy files, duplicates of the files will remain stored in the product
- If you move files, the files will be deleted in the product



- ▶ Tap **File management** in the main menu
- ▶ In the **Internal** storage location, navigate to the file you want to export
- ▶ Drag the icon of the file to the right
- The operating elements are displayed.



- ▶ To copy the file, tap **Copy file**



- ▶ To move the file, tap **Move file**
- ▶ In the dialog, select the storage location to which you want to export the file
- ▶ Tap **Select**
- The file is exported to the USB mass storage device or the network drive.

Safely removing a USB mass storage device



- ▶ Tap **File management** in the main menu
- ▶ Navigate to the list of storage locations



- ▶ Tap **Safely remove**
- > The message **The storage medium can be removed now.** appears.
- ▶ Disconnect the USB mass storage device

6.6 Importing files

You can import files from a USB mass storage device (FAT32 format) or a network drive into the product. You can either copy or move the files:

- If you copy files, duplicates of the files will remain on the USB mass storage device or the network drive
- If you move files, the files will be deleted from the USB mass storage device or the network drive



- ▶ Tap **File management** in the main menu
- ▶ On the USB mass storage device or network drive, navigate to the file you want to import
- ▶ Drag the icon of the file to the right
- > The operating elements are displayed.



- ▶ To copy the file, tap **Copy file**



- ▶ To move the file, tap **Move file**
- ▶ In the dialog, select the storage location to which you want to save the file
- ▶ Tap **Select**
- > The file is stored on the product.

Safely removing a USB mass storage device



- ▶ Tap **File management** in the main menu
- ▶ Navigate to the list of storage locations



- ▶ Tap **Safely remove**
- > The message **The storage medium can be removed now.** appears.
- ▶ Disconnect the USB mass storage device

7

Settings

7.1 Overview

This chapter describes the setting options and the associated settings parameters for the product.

The basic setting options and settings parameters for commissioning and product setup are outlined in the respective chapters:

Further information: "Commissioning", Page 81

Further information: "Setup", Page 155

Short description

 Depending on the type of user that is logged in to the product, settings and settings parameters can be edited and changed (edit permission).
If a user logged in to the product has no edit permission for a setting or a settings parameter, the setting or settings parameter is grayed out and cannot be opened or edited.

 Depending on the software options that have been activated on the product, various settings and settings parameters are available in the Settings menu.
If, for example, the POSITIP 8000 NC1 software option is not activated on the unit, then the settings parameters that are necessary for this software option are not displayed on the unit.

Function	Description
General	General settings and information
Interfaces	Configuration of interfaces and network drives
User	Configuration of users
Axes	Configuration of connected encoders and error compensation
Service	Configuration of software options, service functions and information

Calling up



- ▶ Tap **Settings** in the main menu

7.2 General

This chapter describes settings for configuring the operation and display .

Parameter	Further information
Device information	"Device information", Page 182
Screen	"Screen", Page 183
Display	"Display", Page 184
User interface	"User interface", Page 186
Simulation window	"Simulation window", Page 185
Input devices	"Configuring operation with a mouse or touchscreen", Page 166
Sounds	"Sounds", Page 187
Printers	"Printers", Page 187
Date and time	"Setting the date and time", Page 89
Units	"Setting the units of measure", Page 89
Copyrights	"Copyrights", Page 187
Service info	"Service info", Page 187
Documentation	"Documentation", Page 188

7.2.1 Device information

Settings ► General ► Device information

The overview displays basic information about the software.



Parameter	Displays the information
Product designation	Product designation of the product
Part number	ID number of the unit
Serial number	Serial number of the product
Firmware version	Version number of the firmware
Firmware built on	Firmware creation date
Last firmware update on	Date of most recent firmware update
Free memory space	Free memory space in the internal storage location Internal
Free working memory (RAM)	Free RAM on the system
Number of unit starts	Number of times the product was started up with the current firmware
Operating time	Operating time of the product with the current firmware

7.2.2 Screen

Settings ► General ► Screen

Parameter	Explanation
Brightness	Brightness of the screen <ul style="list-style-type: none"> ■ Setting range: 1 % ... 100 % ■ Default setting: 85 %
Energy-save-mode timeout	Time until energy-save mode is activated <ul style="list-style-type: none"> ■ Setting range: 0 min ... 120 min If the value is set to 0, the power-saving mode is deactivated ■ Default setting: 30 minutes
Quit the energy saving mode	Required actions to reactivate the screen <ul style="list-style-type: none"> ■ Tap and drag: Touch the touchscreen and drag the arrow upwards from the lower edge ■ Tap: Touch the touchscreen ■ Tap or axis movement: Touch the touchscreen or move the axis ■ Default setting: Tap and drag

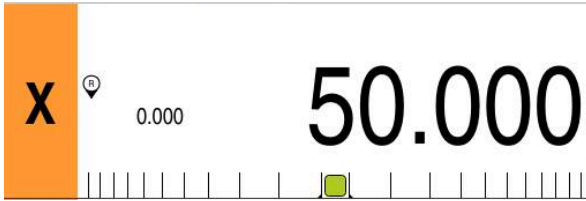
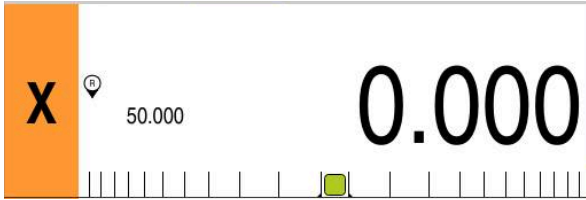
7.2.3 Display
Settings ► General ► Display

Parameter	Explanation
Position display	<p>Configuration of the position display in the MDI mode and Program Run operating mode. The configuration also determines the actions requested by the wizard in the MDI and Program Run operating modes:</p> <ul style="list-style-type: none"> ■ Position with distance to go: The wizard prompts you to move the axis to the displayed position. ■ Distance to go with position: The wizard prompts you to move the axis to 0; a positioning aid is shown. <p>Settings:</p> <ul style="list-style-type: none"> ■ Position: The position is displayed in large digits  <ul style="list-style-type: none"> ■ Position with distance to go: The position is displayed in large digits and the distance to go in small digits  <ul style="list-style-type: none"> ■ Distance to go with position: The distance to go is displayed in large digits, and the position in small digits  <ul style="list-style-type: none"> ■ Default setting: Distance to go with position
Position values	<p>The position values can describe the actual values or nominal values of the axes.</p> <p>Settings:</p> <ul style="list-style-type: none"> ■ Actual value ■ Nominal value ■ Default setting: Actual value
Distance-to-go indicator	<p>Display of the distance-to-go indicator in MDI mode</p>  <ul style="list-style-type: none"> ■ Settings: ON or OFF ■ Default value: ON

Parameter	Explanation
Digits before the decimal point for size-adjusted axis display	The number of digits in front of the decimal point indicates the size at which the position values are displayed. If the number of digits in front of the decimal point is exceeded, then the display is reduced in size so that all of the digits can be shown. <ul style="list-style-type: none"> ■ Setting range: 1 ... 6 ■ Default value: 3
Simulation window	Configuration of the simulation window for MDI mode and program run. <p>Further information: "Simulation window", Page 185</p>
Radial machining axes	Display of the radial machining axis Settings: <ul style="list-style-type: none"> ■ Radius ■ Diameter ■ Default value: Radius

7.2.4 Simulation window

Settings ► General ► Display ► Simulation window

Parameter	Explanation
Line thickness of tool position	Line thickness for displaying the tool position <ul style="list-style-type: none"> ■ Settings: Standard or Bold ■ Default value: Standard
Color of tool position	Definition of the color for displaying the tool position <ul style="list-style-type: none"> ■ Setting range: Color scale ■ Default setting: Orange
Line thickness of current contour element	Line thickness for displaying the current contour element <ul style="list-style-type: none"> ■ Settings: Standard or Bold ■ Default value: Standard
Color of current contour element	Definition of the color for displaying the current contour element <ul style="list-style-type: none"> ■ Setting range: Color scale ■ Default setting: Green
Tool path	Use of the tool path <ul style="list-style-type: none"> ■ Settings: ON or OFF ■ Default value: ON
Tool always visible	The tool is always visible in the simulation window. The contour and the current position of the tool are shown. The area is scaled during the procedure <ul style="list-style-type: none"> ■ Settings: ON or OFF ■ Default value: OFF
Horizontal alignment	Horizontal orientation of the coordinate system in the simulation window Settings: <ul style="list-style-type: none"> ■ Rightward: Values increase to the right ■ Leftward: Values increase to the left ■ Default value: Rightward

Parameter	Explanation
Vertical alignment	Vertical orientation of the coordinate system in the simulation window Settings: <ul style="list-style-type: none"> ■ Upward: Values increase in the upward direction ■ Downward: Values increase in the downward direction ■ Default value: Upward
Minimum display range	Area in the simulation window that will not be zoomed into further. The area always remains visible <ul style="list-style-type: none"> ■ Setting range: 0 mm ... 1000 mm ■ Default value: 0



The **Undo** buttons enable the color definitions of the simulation window to be reset to factory settings.

7.2.5 User interface

Settings ► General ► User interface

Parameter	Explanation
Response time for zeroing via axis label	Time for how long the axis label must be held for zeroing <ul style="list-style-type: none"> ■ Setting range: 500 ms ... 5000 ms ■ Default value: 500
Response time for applying values in OEM bar	Time for how long the bar entry of the OEM bar must be held to load the value; the parameter appears if the OEM bar is activated in the OEM area <ul style="list-style-type: none"> ■ Setting range: 500 ms ... 5000 ms ■ Default value: 2000

7.2.6 Sounds

Settings ► General ► Sounds

The available sounds are grouped into categories. The sounds differ within a category.

Parameter	Explanation
Speaker	Use of the built-in speaker rear panel of the product <ul style="list-style-type: none"> ■ Settings: ON or OFF ■ Default setting: ON
Speaker volume	Volume of the product's speaker <ul style="list-style-type: none"> ■ Setting range: 0 % ... 100 % ■ Default setting: 50 %
Message and Error	Sound to be played when a message is displayed When you select a setting, the associated sound is played <ul style="list-style-type: none"> ■ Settings: Standard, Guitar, Robot, Outer space, No sound ■ Default setting: Standard
Touch tone	Sound to be played when using a touch element When you select a setting, the associated sound is played <ul style="list-style-type: none"> ■ Settings: Standard, Guitar, Robot, Outer space, No sound ■ Default setting: Standard

7.2.7 Printers

Settings ► General ► Printers

 The current firmware of the units in this series does not support this function.

7.2.8 Copyrights

Settings ► General ► Copyrights

Parameter	Meaning and function
Open source software	Display of the licenses of the software used

7.2.9 Service info

Settings ► General ► Service info

Parameter	Meaning and function
HEIDENHAIN - Customer service	Display of a document containing HEIDENHAIN service addresses
OEM service info	Display of a document containing service information from the machine manufacturer <ul style="list-style-type: none"> ■ Default: document containing HEIDENHAIN service addresses Further information: "Adding documentation", Page 142

7.2.10 Documentation

Settings ► General ► Documentation

Parameter	Meaning and function
Operating Instructions	<p>Display of the operating instructions stored on the product</p> <ul style="list-style-type: none">■ Default: no document; the document in the desired language can be added <p>Further information: "Adding the Operating Instructions", Page 163</p>

7.3 Interfaces

This chapter describes settings for configuring networks, network drives, and USB mass storage devices.

Parameter	Further information
Network	"Configuring the network", Page 164
Network drive	"Configuring the network drive", Page 165
USB	"USB", Page 189
Axes (switching functions)	"Axes (switching functions)", Page 189
Position-dependent switching functions	"Position-dependent switching functions", Page 189

7.3.1 USB

Settings ► Interfaces ► USB

Parameter	Explanation
Automatically detect attached USB mass storage devices	Automatic recognition of a USB mass storage device <ul style="list-style-type: none"> ■ Settings: ON or OFF ■ Default setting: ON

7.3.2 Axes (switching functions)

Settings ► Interfaces ► Switching functions ► Axes

In the Manual operation and MDI modes of operation, all axes or individual axes can be reset to zero by setting the assigned digital input.



Not all of the described parameters and options may be available, depending on the product version, configuration and the connected encoders.

Parameter	Explanation
General settings	Assignment of the digital input in accordance with the pin layout in order to zero all axes Default setting: Not connected
<Axis name>	Assignment of the digital input in accordance with pin layout in order to set all axes to zero Default setting: Not connected

7.3.3 Position-dependent switching functions

Settings ► Interfaces ► Position-dependent switching functions ► +

The position-dependent switching functions enable you to set logical outputs depending on the position of an axis in a defined reference system. Switching positions and position intervals are available for this.



Not all of the described parameters and options may be available, depending on the product version, configuration and the connected encoders.

Parameter	Explanation
Name	Name of the switching function
Switching function	Selecting whether the switching function should be activated or deactivated <ul style="list-style-type: none"> ■ Settings: ON or OFF ■ Default setting: ON
Reference system	Selecting the desired reference system <ul style="list-style-type: none"> ■ Machine coordinate system ■ Preset ■ Target position ■ Tool tip
Axis	Selecting the desired axis
Switching point	Selecting the axis position of the trigger point Default setting: 0.0000
Type of switching	Selecting the desired type of switching <ul style="list-style-type: none"> ■ Edge from LOW to HIGH ■ Edge from HIGH to LOW ■ Interval from LOW to HIGH ■ Interval from HIGH to LOW ■ Default setting: Edge from LOW to HIGH
Output	Selecting the desired output <ul style="list-style-type: none"> ■ X105.13 ... X105.16 (Dout 0, Dout 2, Dout 4, Dout 6) ■ X105.32 ... X105.35 (Dout 1, Dout 3, Dout 5, Dout 7) ■ X113.04 (Dout 0)
Output is inverted	If the function is enabled, the output is set if the switching condition is not fulfilled or if the switching function is inactive <ul style="list-style-type: none"> ■ Default value: Not active
Pulse	Selecting whether the pulse should be activated or deactivated <ul style="list-style-type: none"> ■ Settings: ON or OFF ■ Default setting: ON
Pulse time	Selecting the desired pulse length <ul style="list-style-type: none"> ■ 0.1 s ... 999 s ■ Default setting: 0.0 s
Lower limit	Selecting the lower limit of the axis position at which switching is to occur (only with Interval type of switching)
Upper limit	Selecting the upper limit of the axis position at which switching is to occur (only Interval type of switching)
Remove the entry	Removing the position-dependent switching function

7.4 User

This chapter describes settings for configuring users and user groups.

Parameter	Further information
OEM	"OEM", Page 191
Setup	"Setup", Page 191
Operator	"Operator", Page 192
Adding a User	"Creating a user and password", Page 162

7.4.1 OEM

Settings ► User ► OEM

The **OEM** (Original Equipment Manufacturer) user has the highest level of permissions. This user is allowed to configure the product's hardware (e.g. connection of encoders and sensors). He can create **Setup** and **Operator**-type users, and configure the **Setup** and **Operator** users. The **OEM** user cannot be duplicated or deleted. This user cannot be logged in automatically.

Parameters	Explanation	Edit permission
Name	Name of the user ■ Default value: OEM	–
First name	First name of the user ■ Default value: –	–
Department	Department of the user ■ Default value: –	–
Group	Group of the user ■ Default value: oem	–
Password	Password of the user ■ Default value: oem	OEM
Language	Language of the user	OEM
Auto login	On restart of the product: Automatic login of the last logged-in user ■ Default value: OFF	–
Remove user account	Removal of the user account	–

7.4.2 Setup

Settings ► User ► Setup

The **Setup** user configures the product for use at the place of operation. This user can create **Operator**-type users. The **Setup** user cannot be duplicated or deleted. This user cannot be logged in automatically.

Parameters	Explanation	Edit permission
Name	Name of the user ■ Default value: Setup	–
First name	First name of the user ■ Default value: –	–

Parameters	Explanation	Edit permission
Department	Department of the user ■ Default value: –	–
Group	Group of the user ■ Default value: setup	–
Password	Password of the user ■ Default value: setup	Setup, OEM
Language	Language of the user	Setup, OEM
Auto login	On restart of the product: Automatic login of the last logged-in user ■ Default value: OFF	–
Remove user account	Removal of the user account	–

7.4.3 Operator

Settings ► User ► Operator

The **Operator** user is permitted to use the basic functions of the product. An **Operator**-type user cannot create additional users, but is allowed to edit various operator-specific settings, such as his name or the language. A user of the **Operator** group can be logged in automatically as soon as the product is switched on.

Parameters	Explanation	Edit permission
Name	Name of the user ■ Default value: Operator	Operator, Setup, OEM
First name	First name of the user	Operator, Setup, OEM
Department	Department of the user ■ Default value: –	Operator, Setup, OEM
Group	Group of the user ■ Default value: operator	–
Password	Password of the user ■ Default value: operator	Operator, Setup, OEM
Language	Language of the user	Operator, Setup, OEM
Auto login	On restart of the product: Automatic login of the last logged-in user ■ Settings: ON or OFF ■ Default value: OFF	Operator, Setup, OEM
Remove user account	Removal of the user account	Setup, OEM

7.5 Axes

This chapter describes settings for configuring the axes and assigned devices.



Not all of the described parameters and options may be available, depending on the product version, configuration and the connected encoders.

General settings

Settings ► Axes ► General settings

Parameter	Further information
Reference marks	"Reference marks", Page 139
Information	"Information", Page 195
Switching functions	"Switching functions", Page 121
Inputs (Switching functions)	"Inputs (Switching functions)", Page 121
Outputs (Switching functions)	"Outputs (Switching functions)", Page 123
Overrides	"Overrides", Page 123
M functions Adding	"Configuring M functions", Page 140
M functions Configuring	"Configuring M functions", Page 140
Diameter axis	"Diameter axis", Page 137
Special settings	"Special settings", Page 124
Central drive	"Configuring the central drive", Page 104
Virtual axis keys	"Configuring virtual axis keys", Page 125
Thread cutting	"Configuring thread cutting (NC software option)", Page 138

Axis-specific settings

Settings ► Axes ► <Axis name> (settings of the axis)

Parameter	Further information
<Axis name> (settings of the axis)	"Configuring the axes", Page 90
Encoder	"Configuring axes for encoders with EnDat interface", Page 93 "Configuring the axes for encoders with a 1 V _{PP} or 11 μA _{PP} interface", Page 94
Reference marks (Encoder)	1 V _{PP} : "Reference marks (Encoder)", Page 97
Reference point displacement	EnDat: "Reference point displacement", Page 94 1 V _{PP} : "Reference point displacement", Page 94
Diagnostics for encoders with EnDat	"Diagnostics for encoders with EnDat interface", Page 204
Diagnostics for encoders with 1 V _{PP} /11 μA _{PP}	"Diagnostics for encoders with 1 V _{PP} /11 μA _{PP} interface", Page 203
Linear error compensation (LEC)	"Configuring linear error compensation (LEC)", Page 100
Segmented linear error compensation (SLEC)	"Configuring segmented linear error compensation (SLEC)", Page 101
Create table of supporting points	"Create table of supporting points", Page 102
Outputs	"Outputs", Page 113
Inputs	"Inputs", Page 117
Movement commands from digital input	"Movement commands from digital input", Page 117
Movement commands from analog input	"Movement commands from analog input", Page 118
Movement commands from electronic handwheel	"Configuring an Electronic handwheel", Page 134
Digital enable inputs	"Digital enable inputs", Page 119
Software limit switches	"Software limit switches", Page 120
Spindle axis S	"Spindle axis S", Page 127
Outputs (S)	"Outputs (S)", Page 129
Inputs (S)	"Inputs (S)", Page 131
Movement commands from digital input (S)	"Movement commands from digital input (S)", Page 132
Digital enable inputs (S)	"Digital enable inputs (S)", Page 132
Spindle speed display via analog input (S)	"Spindle speed display via analog input (S)", Page 133
Gear stages add	"Adding Gear stages", Page 133
Gear stages	"Gear stages", Page 134

7.5.1 Information

Settings ► Axes ► General settings ► Information

Parameters	Explanation
Assignment of the encoder inputs to the axes	Shows the assignment of the encoder inputs to the axes
Assignment of the analog outputs to the axes	Shows the assignment of the analog outputs to the axes
Assignment of the analog inputs to the axes	Shows the assignment of the analog inputs to the axes
Assignment of the digital outputs to the axes	Shows the assignment of the digital outputs to the axes
Assignment of the digital inputs to the axes	Shows the assignment of the digital inputs to the axes



With the **Reset** buttons, the assignments for the inputs and outputs can be reset.

7.6 Service

This chapter describes settings for product configuration, for maintaining the firmware and for enabling software options.

Parameter	Further information
Firmware information	"Firmware information", Page 197
Back up and restore	"Back up settings", Page 153 "Back up user files", Page 154 "Restore user files", Page 208 "Restoring settings", Page 209
Firmware update	"Updating the firmware", Page 201
Reset	"Reset all settings", Page 210 "Reset to shipping conditions", Page 210
OEM area	"OEM area", Page 141
Documentation (OEM service info)	"Adding documentation", Page 142
Startup screen	"Adding a startup screen", Page 142
OEM bar	"Configuring the OEM bar", Page 142
Adding OEM bar entries	"Configuring the OEM bar", Page 142
OEM bar entries Logo	"Configuring the OEM logo", Page 143
OEM bar entries Spindle speed	"Configuring nominal values for the spindle speed", Page 144
OEM bar entries M function	"Configuring M functions", Page 145
OEM bar entries Special functions	"Configuring special functions", Page 146
OEM bar entries Document	"Configuring documents", Page 147
Settings (OEM area)	"OEM area", Page 141
Program run	"Adjusting the program execution", Page 148
M function add	"Configuring M functions", Page 149
Text database	"Creating a Text database ", Page 150
Messages	"Configuring error messages", Page 151
Back up and restore (OEM area)	"Backing up and restoring OEM settings", Page 151
Documentation	"Adding the Operating Instructions", Page 163
Software options	"Activating Software options", Page 86

7.6.1 Firmware information

Settings ► Service ► Firmware information

The following information on the individual software modules is displayed for service and maintenance.

Parameter	Explanation
Core version	Version number of the microkernel
Microblaze bootloader version	Version number of the Microblaze bootloader
Microblaze firmware version	Version number of the Microblaze firmware
Extension PCB bootloader version	Version number of the bootloader (expansion board)
Extension PCB firmware version	Version number of the firmware (expansion board)
Boot ID	ID number of the boot process
HW Revision	Revision number of the hardware
C Library Version	Version number of the C library
Compiler Version	Version number of the compiler
Touchscreen Controller version	Version number of the touchscreen controller
Number of unit starts	Number of times the product was switched on
Qt build system	Version number of the Qt compilation software
Qt runtime libraries	Version number of the Qt runtime libraries
Kernel	Version number of the Linux kernel
Login status	Information on the logged-in user
SystemInterface	Version number of the system interface module
BackendInterface	Version number of the backend interface module
GuiInterface	Version number of the user interface module
TextDataBank	Version number of the text database module
Optical edge detection	Version number of the optical edge detection module
NetworkInterface	Version number of the network interface module
OSInterface	Version number of the operating system interface module
PrinterInterface	Version number of the printer interface module
system.xml	Version number of the system parameters
axes.xml	Version number of the axis parameters
encoders.xml	Version number of the encoder parameters
ncParam.xml	Version number of the NC parameters
spindle.xml	Version number of the spindle axis parameters
io.xml	Version number of the parameters for inputs and outputs
mFunctions.xml	Version number of the M function parameters
peripherals.xml	Version number of the parameters for peripherals
slec.xml	Version number of the parameters for segmented linear error compensation (SLEC)
lec.xml	Version number of the parameters for linear error compensation (LEC)

Parameter	Explanation
microBlazePVRegister.xml	Version number of the "Processor Version Register" of MicroBlaze
info.xml	Version number of the information parameters
audio.xml	Version number of the audio parameters
network.xml	Version number of the network parameters
os.xml	Version number of the operating system parameters
runtime.xml	Version number of the runtime parameters
users.xml	Version number of the user parameters
GI Patch Level	Patch level of the golden image (GI)

8

**Servicing and
Maintenance**

8.1 Overview

This chapter describes the general maintenance work on the product.

 The following steps must be performed only by qualified personnel.
Further information: "Personnel qualification", Page 16

 This chapter contains a description of maintenance work for the product only. Any maintenance work on peripheral devices is not described in this chapter.
Further information: Manufacturer's documentation for the respective peripheral devices

8.2 Cleaning

NOTICE

Cleaning with sharp-edged objects or aggressive cleaning agents

Improper cleaning will cause damage to the product.

- ▶ Never use abrasive or aggressive cleaners, and never use strong detergents or solvents
- ▶ Do not use sharp-edged objects to remove persistent contamination

Cleaning the housing

- ▶ Use only a cloth dampened with water and a mild detergent for cleaning the exterior surfaces

Cleaning the screen

Activate cleaning mode to clean the display. This switches the unit to an inactive state without interrupting the power supply. The screen is switched off in this state.



- ▶ Tap **Switch-off** in the main menu to activate the cleaning mode



- ▶ Tap **Cleaning mode**
- > The screen switches off.
- ▶ Use a lint-free cloth and a commercially available glass cleaner to clean the screen



- ▶ To deactivate the cleaning mode, tap anywhere on the touchscreen
- > An arrow appears at the bottom of the screen.
- ▶ Drag the arrow up
- > The screen is switched on and shows the user interface last displayed.

8.3 Maintenance plan

The product is largely maintenance-free.

NOTICE
<p>Operating defective devices</p> <p>Operating defective devices may result in serious consequential damage.</p> <ul style="list-style-type: none"> ▶ Do not repair or operate the device if it is damaged ▶ Replace defective devices immediately or contact a HEIDENHAIN service agency

	<p>The following steps are only to be performed by electrical specialists.</p> <p>Further information: "Personnel qualification", Page 16</p>
---	--

Maintenance step	Interval	Corrective action
▶ All labels and symbols provided on the product must be checked for readability	Annually	▶ Contact HEIDENHAIN service agency
▶ Inspect electrical connections for damage and check their function	Annually	▶ Replace defective cables. Contact HEIDENHAIN service agency if required
▶ Check power cables for faulty insulation and weak points	Annually	▶ Replace power cables according to the specification

8.4 Resuming operation

When operation is resumed, for example when the product is reinstalled after repair or when it is remounted, the same measures and personnel requirements apply as for mounting and installing the product.

Further information: "Mounting", Page 65

Further information: "Installation", Page 71

When connecting the peripheral devices (e.g., encoders), the operating company must ensure safe resumption of operation and assign authorized and appropriately qualified personnel to the task.

Further information: "Obligations of the operating company", Page 17

8.5 Updating the firmware

The firmware is the operating system of the product. You can import new versions of the firmware via the product's USB port or the network connection.

	<p>Prior to the firmware update, you must comply with the release notes for the respective software version and the information they contain regarding reverse compatibility.</p>
---	---

	<p>In order to be on the safe side, the current settings must be backed up if the unit's firmware is going to be updated.</p>
---	---

Prerequisite

- The new firmware is available as a *.dro file
- To update the firmware over the USB port, the current firmware must be stored on a USB mass storage device (FAT32 format)
- To update the firmware via the network interface, the current firmware must be available in a folder on the network drive

Starting a firmware update



- ▶ Tap **Settings** in the main menu
- ▶ Tap **Service**
- ▶ Open in succession:
 - **Firmware update**
 - **Continue**
- > The service application is launched.

Updating the firmware

The firmware can be updated from a USB mass storage device (FAT32 format) or via a network drive.



- ▶ Tap **Firmware update**
- ▶ Tap **Select**
- ▶ If required, connect a USB mass storage device to a USB port of the product
- ▶ Navigate to the folder containing the new firmware



If you have accidentally tapped the wrong folder, you can return to the previous folder.

- ▶ Tap the file name that is displayed above the list

- ▶ Select the firmware
- ▶ Tap **Select** to confirm the selection
- > The firmware version information is displayed.
- ▶ Tap **OK** to close the dialog



The firmware update cannot be canceled once the data transfer has started.

- ▶ Tap **Start** to start the update
- > The screen shows the progress of the update.
- ▶ Tap **OK** to confirm successful update
- ▶ Tap **Finish** to terminate the service application
- > The service application is terminated.
- > The main application is launched.
- > If automatic user login is active, the user interface is displayed in the **Manual operation** menu.
- > If automatic user login is not active, the **User login** menu is displayed.

Safely removing a USB mass storage device



- ▶ Tap **File management** in the main menu
- ▶ Navigate to the list of storage locations



- ▶ Tap **Safely remove**
- ▶ The message **The storage medium can be removed now.** appears.
- ▶ Disconnect the USB mass storage device

8.6 Encoder diagnostics

The diagnostic function allows you to perform a basic functional check of the encoders. For absolute encoders with EnDat interface, the messages from the encoder and its functional reserves are displayed. For incremental encoders with 1 V_{PP} or 11 μA_{PP} interface, the displayed values allow you to evaluate the fundamental functioning of the encoders. Based on this initial diagnostic option for encoders, you can initiate further actions for more detailed testing or repair.

i The PWT 101 or PWM 21 from HEIDENHAIN provides further inspection and testing capabilities.
For more information, please refer to www.heidenhain.com.

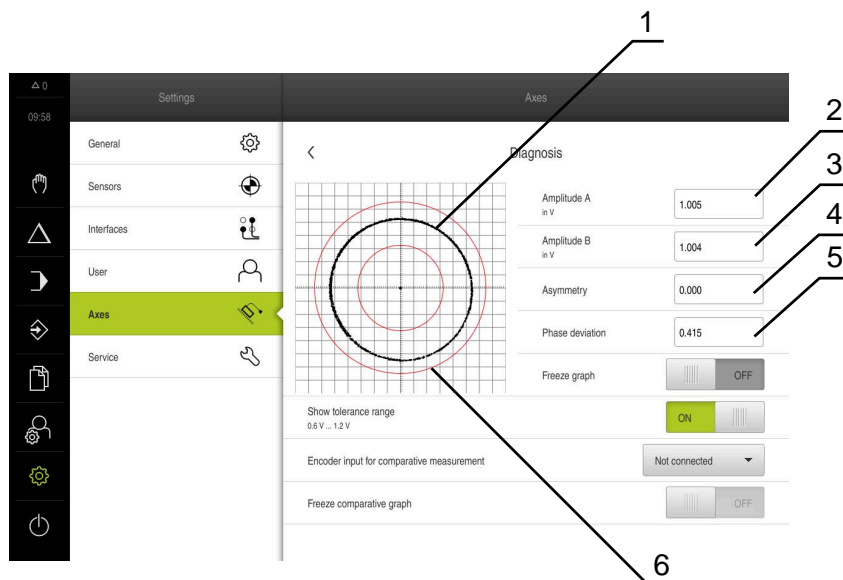

8.6.1 Diagnostics for encoders with 1 V_{PP}/11 μA_{PP} interface

For encoders with 1 V_{PP}/11 μA_{PP} interface, you can evaluate the functioning of the encoder based on the signal amplitudes, asymmetry, and phase deviation. These values are also displayed graphically as a Lissajous figure.



- 1 Lissajous figure
- 2 Amplitude A
- 3 Amplitude B
- 4 Asymmetry
- 5 Phase error
- 6 Amplitude tolerances

Settings ▶ Axes ▶ <Axis name> ▶ Encoder ▶ Diagnosis

Parameter	Explanation
Amplitude A	Display of amplitude A in volts (V)
Amplitude B	Display of amplitude B in volts (V)
Asymmetry	Asymmetry value
Phase deviation	Phase deviation from 90°
Freeze graph	Freezing of Lissajous figure Settings: <ul style="list-style-type: none"> ■ ON: The graph is frozen and is not updated when the encoder is moved ■ OFF: The graph is not frozen and is updated when the encoder is moved ■ Default value: OFF
Show tolerance range	Display of tolerance circles in a range from 0.6 V to 1.2 V Settings: <ul style="list-style-type: none"> ■ ON: Two red circles are shown ■ OFF: Tolerance circles are hidden ■ Default value: OFF
Encoder input for comparative measurement	Display of another encoder at another encoder input for comparative measurement; the "Freeze graph" parameter allows you to superimpose the circles Settings: <ul style="list-style-type: none"> ■ Selection of desired encoder input ■ Default value: Not connected <div style="border: 1px solid black; padding: 5px; margin-top: 10px;"> <p> The parameter is available only if another encoder with 1 V_{PP} or 11 μA_{PP} interface is connected.</p> </div>
Freeze comparative graph	The Lissajous figure of the encoder at the encoder input is frozen for comparative measurement Settings: <ul style="list-style-type: none"> ■ ON: The graph is frozen and is not updated when the encoder is moved ■ OFF: The graph is not frozen and is updated when the encoder is moved ■ Default value: OFF <div style="border: 1px solid black; padding: 5px; margin-top: 10px;"> <p> The parameter is available only if another encoder with 1 V_{PP} or 11 μA_{PP} interface is connected.</p> </div>

8.6.2 Diagnostics for encoders with EnDat interface

You can check the encoders with EnDat interface for proper functioning by reading out the errors or warnings and by evaluating their functional reserves.

Depending on the encoder, not all of the functional reserves and messages are supported.

Functional reserves

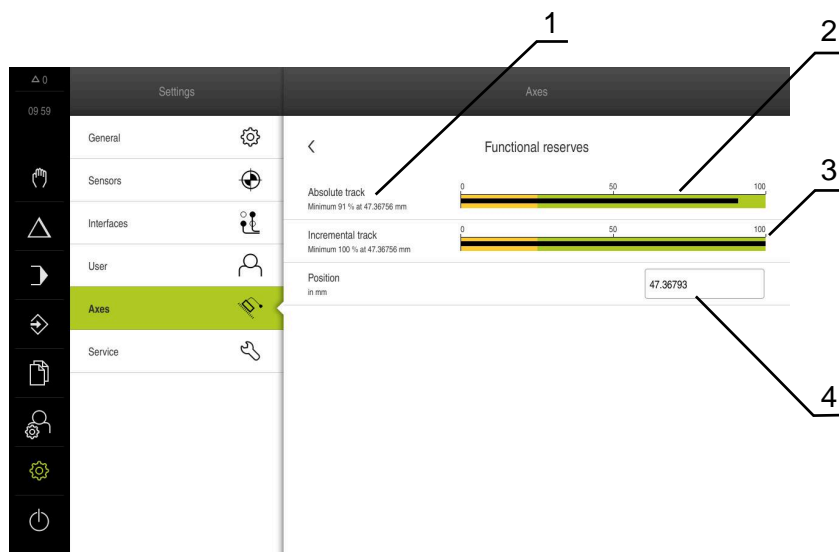

Figure 28: Example of functional reserves of a length gauge

- 1 Minimum percentage value of functional reserves at this specific position
- 2 Absolute track
- 3 Incremental track
- 4 Current position of encoder

Path: **Settings ► Axes ► <Axis name> ► Encoder ► Diagnosis Functional reserves**

Parameter	Explanation
Absolute track	Displays the functional reserves of the absolute track
Incremental track	Displays the functional reserves of the incremental track
Position value calculation	Displays the functional reserves of position value calculation
Position	Displays the actual current position of the encoder

The product displays the functional reserves in a bar graph:

Color	Range	Evaluation
Yellow	0 % ... 25 %	Servicing/maintenance recommended; testing recommended (e.g., with PWT 101)
Green	25 % ... 100%	The encoder is within the specification

Errors and warnings

Settings ► Axes ► <Axis name> ► Encoder ► Diagnosis

Message	Description
Encoder error	Encoder errors indicate a malfunction of the encoder Examples of encoder errors that may be displayed: <ul style="list-style-type: none"> ■ Failure of the light unit ■ Incorrect signal amplitude ■ Incorrect position ■ Overvoltage ■ Undervoltage supply ■ Overcurrent ■ Battery failure
Encoder warning	Encoder warnings indicate that certain tolerance limits of the encoder have been reached or exceeded Examples of encoder warnings that may be displayed: <ul style="list-style-type: none"> ■ Frequency collision ■ Temperature exceedance ■ Light-source control reserve ■ Battery charge ■ Reference point

The messages can have the following status:

Status	Evaluation
OK!	The encoder is within the specification
Not supported	Message not supported by the encoder
Error!	Servicing/maintenance recommended; detailed analyses recommended (e.g., with PWT 101)

8.7 Restoring files and settings

You can restore saved files and settings to a device.

The following sequence should be followed when restoring files and settings:

- Restore OEM-specific folders and files
- Restore user files
- Restoring settings

An automatic restart of the product is performed only after the settings have been restored.

8.7.1 Restore OEM-specific folders and files

Backed-up OEM-specific folders and files of the product can be loaded onto a device. This allows you to restore the configuration of a device while restoring the settings.

Further information: "Restoring settings", Page 209

If servicing becomes necessary, an exchange unit can thus be operated with the configuration of the failed unit once the settings have been restored, provided that both units use the same or compatible firmware versions.

Settings ▶ Service ▶ OEM area ▶ Back up and restore

Parameter	Explanation
Restore OEM specific folders and files	Restoring the settings of the OEM area as a ZIP file

- ▶ **Restore OEM specific folders and files**
- ▶ Tap **Load as ZIP**
- ▶ If required, connect a USB mass storage device (FAT32 format) to a USB port of the product
- ▶ Navigate to the folder containing the backup file
- ▶ Select the backup file
- ▶ Tap **Select**
- ▶ Confirm the successful transfer with **OK**



There is no automatic restart when the OEM-specific folders and files are restored. A restart is performed when the settings are restored.

Further information: "Restoring settings", Page 209

- ▶ To restart the product with the transferred OEM-specific folders and files, switch the product off and then back on

Safely removing a USB mass storage device



- ▶ Tap **File management** in the main menu
- ▶ Navigate to the list of storage locations
- ▶ Tap **Safely remove**
- ▶ The message **The storage medium can be removed now.** appears.
- ▶ Disconnect the USB mass storage device



8.7.2 Restore user files

Backed-up user files of the product can be loaded into the product again. Existing user files will be overwritten. This, together with the restoring of the settings, enables you to restore the complete configuration of a unit.

If servicing becomes necessary, a replacement unit can be operated with the configuration of the failed unit after restoring. This requires that the version of the old firmware matches that of the new firmware or that the versions are compatible.

 All files from all user groups that are stored in the respective folders are backed up and can be restored as user files.
The files in the **System** folder are not restored.

Settings ▶ Service ▶ Back up and restore

Parameter	Explanation
Restore user files	Restoring of user files of the product

- ▶ **Restore user files**
- ▶ Tap **Load as ZIP**
- ▶ If required, connect a USB mass storage device (FAT32 format) to a USB port of the product
- ▶ Navigate to the folder containing the backup file
- ▶ Select the backup file
- ▶ Tap **Select**
- ▶ Confirm the successful transfer with **OK**

 There is no automatic restart when the user files are restored. A restart is performed when the settings are restored.
"Restoring settings"

- ▶ To restart the product with the transferred user files, switch the product off and then back on

Safely removing a USB mass storage device



- ▶ Tap **File management** in the main menu
- ▶ Navigate to the list of storage locations
- ▶ Tap **Safely remove**
- ▶ The message **The storage medium can be removed now.** appears.
- ▶ Disconnect the USB mass storage device



8.7.3 Restoring settings

Backed-up settings can be restored to the product. The current configuration of the product is replaced in the process.



Software options that were active when the settings were backed up must be activated before restoring the settings on the product.

A restore can be necessary in the following cases:

- During initial operation, the settings are set on a product and transferred to all identical products
Further information: "Steps for commissioning", Page 84
- After a reset, the settings are copied back to the product
Further information: "Reset all settings", Page 210

Settings ▶ Service ▶ Back up and restore

Parameter	Explanation
Restoring settings	Restoring of the backed up settings

- ▶ **Restoring settings**
- ▶ Tap **Complete restoration**
- ▶ If required, connect a USB mass storage device (FAT32 format) to a USB port on the product
- ▶ Navigate to the folder containing the backup file
- ▶ Select the backup file
- ▶ Tap **Select**
- ▶ Confirm the successful transfer with **OK**
- > The system is shut down
- ▶ To restart the product with the transferred configuration data, switch the product off and then back on

Safely removing a USB mass storage device



- ▶ Tap **File management** in the main menu
- ▶ Navigate to the list of storage locations
- ▶ Tap **Safely remove**
- > The message **The storage medium can be removed now.** appears.
- ▶ Disconnect the USB mass storage device



8.8 Reset all settings

You can reset the settings of the product to the factory defaults if required. The software options are deactivated and must be subsequently reactivated with the available license key.

Settings ► Service ► Reset

Parameter	Explanation
Reset all settings	The settings are reset to factory default settings

- ▶ **Reset all settings**
- ▶ Enter password
- ▶ Confirm entry with **RET**
- ▶ To show the password in plain text, activate **Show password**
- ▶ Tap **OK** to confirm the action
- ▶ Tap **OK** to confirm the reset
- ▶ Tap **OK** to confirm shutdown of the product
- > The device is being shut down.
- > All settings are reset.
- > To restart the product, switch it off and then back on.

8.9 Reset to shipping conditions

You can reset the settings of the product to the factory defaults and delete the user files from product's memory area. The software options are deactivated and must be subsequently reactivated with the available license key.

Settings ► Service ► Reset

Parameter	Explanation
Reset to shipping conditions	Resetting of the settings to the factory default setting and deletion of the user files from the unit's memory area

- ▶ **Reset to shipping conditions**
- ▶ Enter password
- ▶ Confirm entry with **RET**
- ▶ To show the password in plain text, activate **Show password**
- ▶ Tap **OK** to confirm the action
- ▶ Tap **OK** to confirm the reset
- ▶ Tap **OK** to confirm shutdown of the device
- > The device is being shut down.
- > All settings are reset and the user files are deleted.
- > To restart the product, switch it off and then back on.

9

Removal and Disposal

9.1 Overview

This chapter contains information and environmental protection specifications that must be observed for correct disassembly and disposal of the device.

9.2 Removal



Removal of the product must be performed only by qualified personnel.

Further information: "Personnel qualification", Page 16

Depending on the connected peripherals, the removal may need to be performed by an electrical specialist.

In addition, the same safety precautions that apply to the mounting and installation of the respective components must be taken.

Removing the product

To remove the product, follow the installation and mounting steps in the reverse order.

Further information: "Installation", Page 71

Further information: "Mounting", Page 65

9.3 Disposal



NOTICE

Incorrect disposal of the product!

Incorrect disposal of the product can cause environmental damage.

- ▶ Do not dispose of electrical waste and electronic components in domestic waste
- ▶ The integrated backup battery must be disposed of separately from the product
- ▶ Forward the product and the backup battery to recycling in accordance with the applicable local disposal regulations

- ▶ If you have any questions about the disposal of the product, please contact a HEIDENHAIN service agency

10

Specifications

10.1 Overview

This chapter contains an overview of the product data and drawings with the product dimensions and mating dimensions.

10.2 Product data

Device			
Housing	Aluminum milled housing		
Housing dimensions	314 mm x 265 mm x 36 mm		
Fastener system, mating dimensions	VESA MIS-D, 100 100 mm x 100 mm		
Display			
Visual display unit	<ul style="list-style-type: none"> ■ LCD widescreen (16:10) color screen 30.7 cm (12.1") ■ 1280 x 800 pixels 		
Display step	Selectable, min. 0.00001 mm		
User interface	User interface (GUI) with touchscreen		
Electrical data			
Supply voltage	<ul style="list-style-type: none"> ■ AC 100 V ... 240 V ($\pm 10\%$) ■ 50 Hz ... 60 Hz ($\pm 5\%$) ■ For devices with ID 1089176-xx: Max. input power 38 W ■ For devices with ID 1089177-xx: Max. input power 79 W 		
Buffer battery	Lithium battery type CR2032; 3.0 V		
Overvoltage category	II		
Number of encoder inputs	Milling application mode: 4 (2 additional inputs can be enabled via software option) Turning application mode: 4		
Encoder interfaces	<ul style="list-style-type: none"> ■ 1 V_{pp}: maximum current 300 mA, max. input frequency 400 kHz ■ 11 μA_{pp}: maximum current 300 mA, max. input frequency 150 kHz ■ EnDat 2.2: maximum current 300 mA 		
Interpolation at 1 V _{pp}	4096-fold		
Touch probe connection	<ul style="list-style-type: none"> ■ Voltage supply DC 5 V or DC 12 V ■ 5 V or floating switching output ■ Max. cable length with HEIDENHAIN cable 30 m 		
Digital inputs	TTL DC 0 V ... +5 V		
	Level	Voltage range	Current range
	High	DC 11 V ... 30 V	2.1 mA ... 6.0 mA
	Low	DC 3 V ... 2.2 V	0.43 mA

Electrical data

Digital outputs	TTL DC 0 V ... +5 V Maximum load 1 k Ω Voltage range DC 24 V (20.4 V ... 28.8 V) Output current max. 150 mA per channel
Relay outputs	For devices with ID 1089177-xx: <ul style="list-style-type: none"> ■ Max. switching voltage AC 30 V / DC 30 V ■ Max. switching current 0.5 A ■ Max. switching capacity 15 W ■ Max. continuous current 0.5 A
Analog inputs	For devices with ID 1089177-xx: Voltage range DC 0 V ... +5 V Resistance 100 Ω \leq R \leq 50 k Ω
Analog outputs	For devices with ID 1089177-xx: Voltage range DC -10 V ... +10 V Maximum load 1 k Ω
5 V voltage outputs	Voltage tolerance \pm 5 %, maximum current 100 mA
Data interface	<ul style="list-style-type: none"> ■ 4 USB 2.0 Hi-Speed (Type A), maximum current 500 mA per USB connection ■ 1 Ethernet 10/100 Mbit/1 Gbit (RJ45)

Environment

Operating temperature	0 °C to +45 °C
Storage temperature	-20 °C to +70 °C
Relative air humidity	10 % to 80 % RH, non-condensing
Altitude	\leq 2000 m

General information

Directives	<ul style="list-style-type: none"> ■ EMC Directive 2014/30/EU ■ Low Voltage Directive 2014/35/EU ■ RoHS Directive 2011/65/EU
Pollution degree	2
Protection EN 60529	<ul style="list-style-type: none"> ■ Front panel and side panels: IP 65 ■ Rear panel: IP 40
Mass	<ul style="list-style-type: none"> ■ 3.5 kg ■ With Single-Pos stand: 3.6 kg ■ With Duo-Pos stand: 3.8 kg ■ With Multi-Pos stand: 4.5 kg ■ With Multi-Pos holder: 4.1 kg

10.3 Product dimensions and mating dimensions

All dimensions in the drawings are in millimeters.

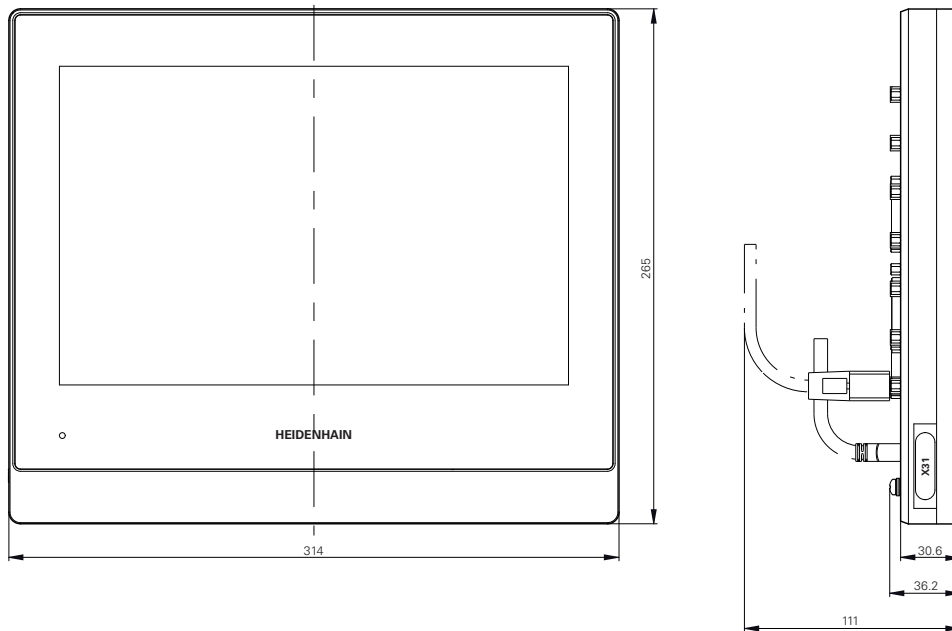

Figure 29: Dimensions of housing

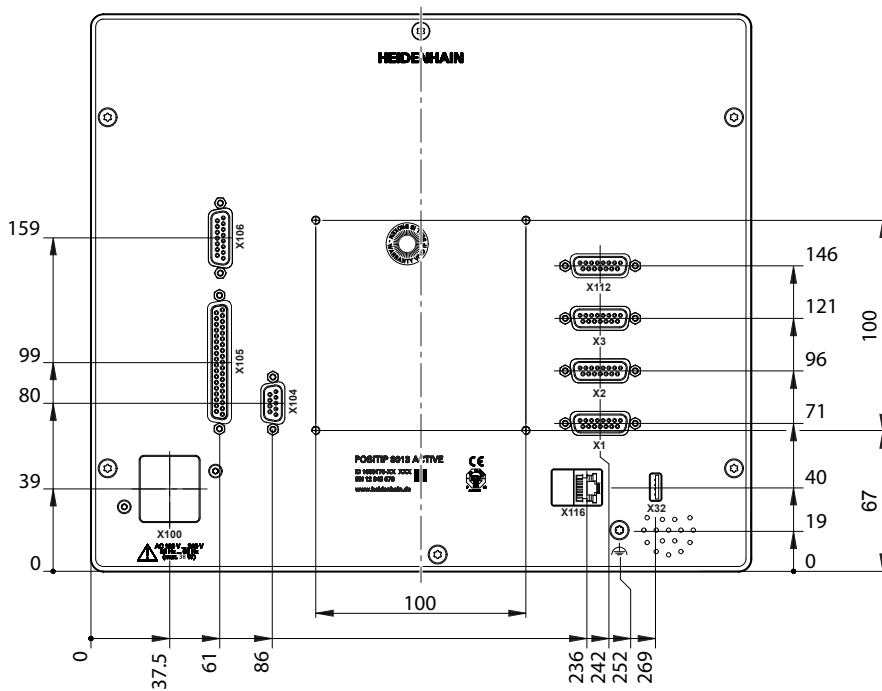

Figure 30: Dimensions of rear panel of the product

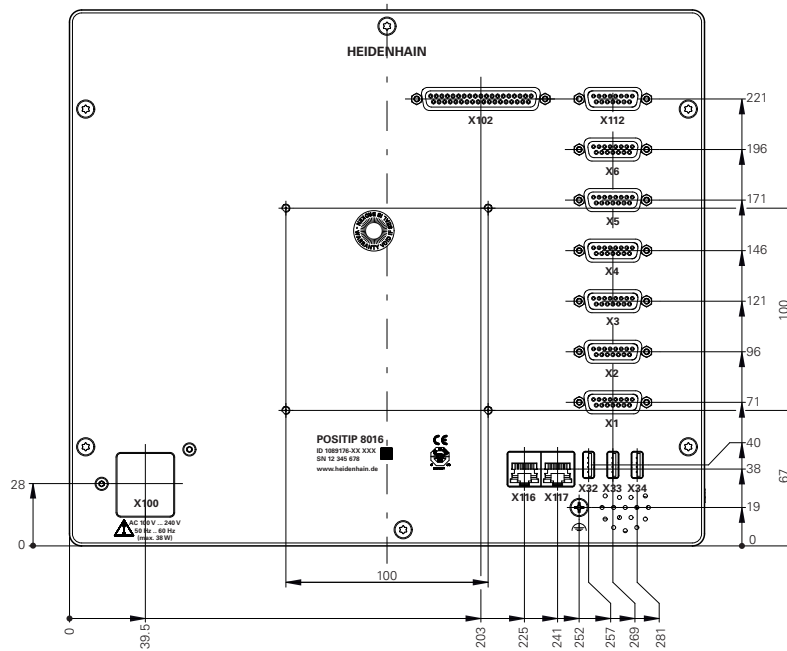

Figure 31: Dimensions of the rear panel for devices with ID 1089176-xx

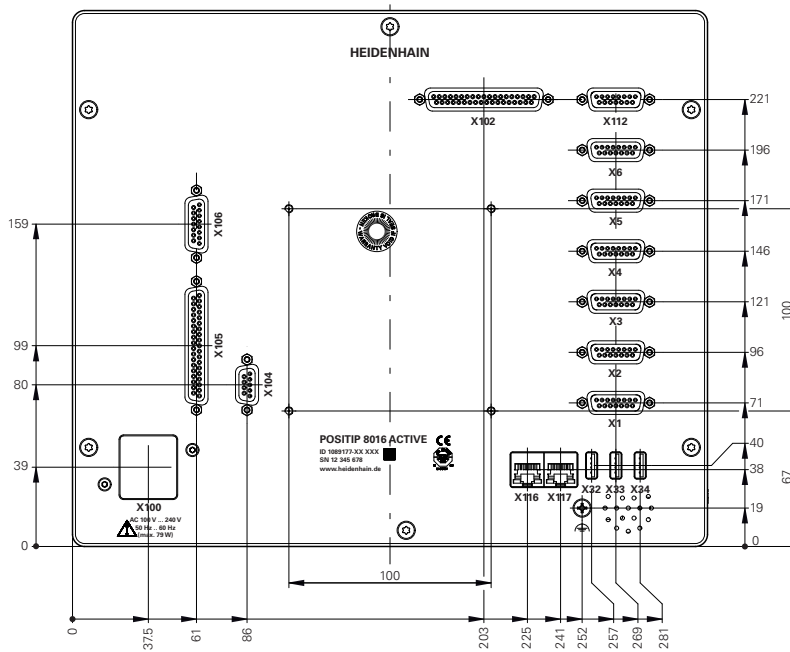

Figure 32: Dimensions of the rear panel for devices with ID 1089177-xx

10.3.1 Product dimensions with Single-Pos stand

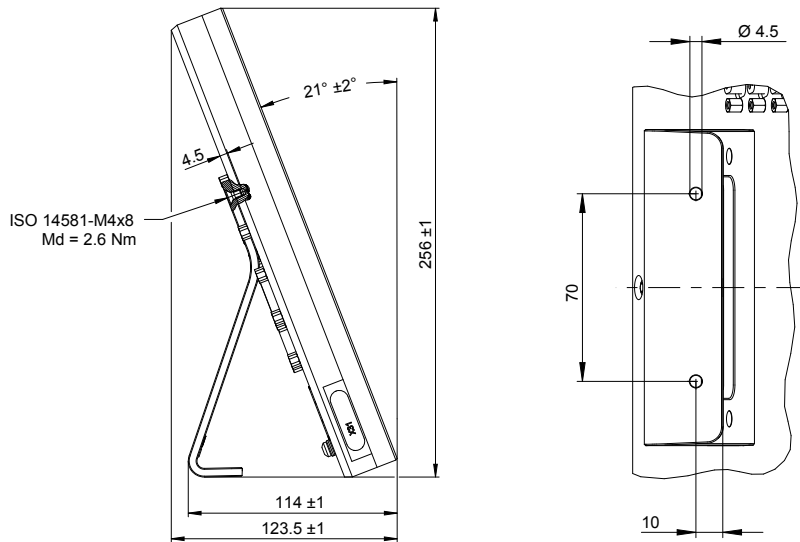

Figure 33: Product dimensions with Single-Pos stand

10.3.2 Product dimensions with Duo-Pos stand

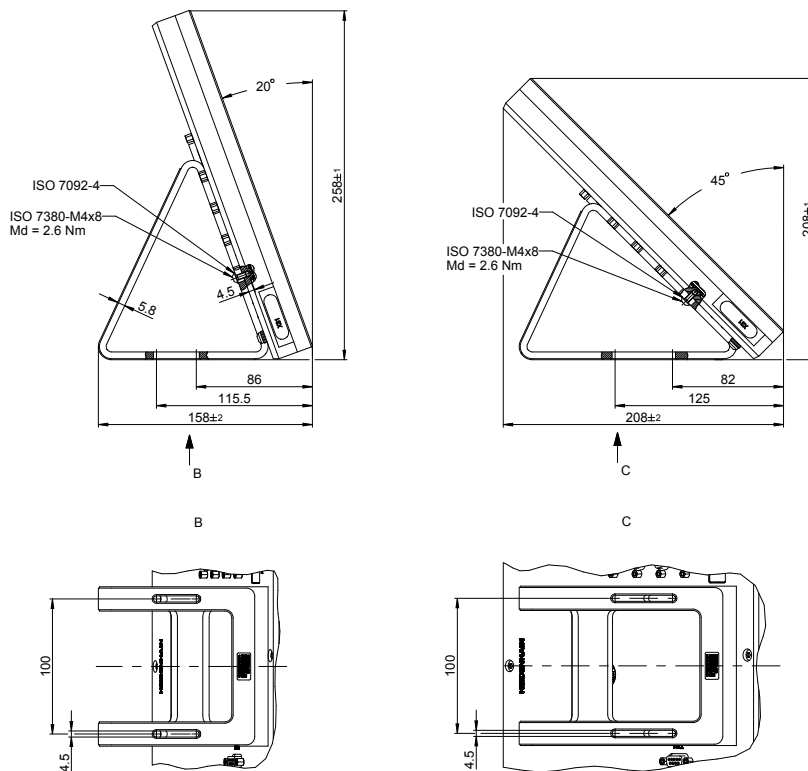

Figure 34: Product dimensions with Duo-Pos stand

10.3.3 Product dimensions with Multi-Pos stand

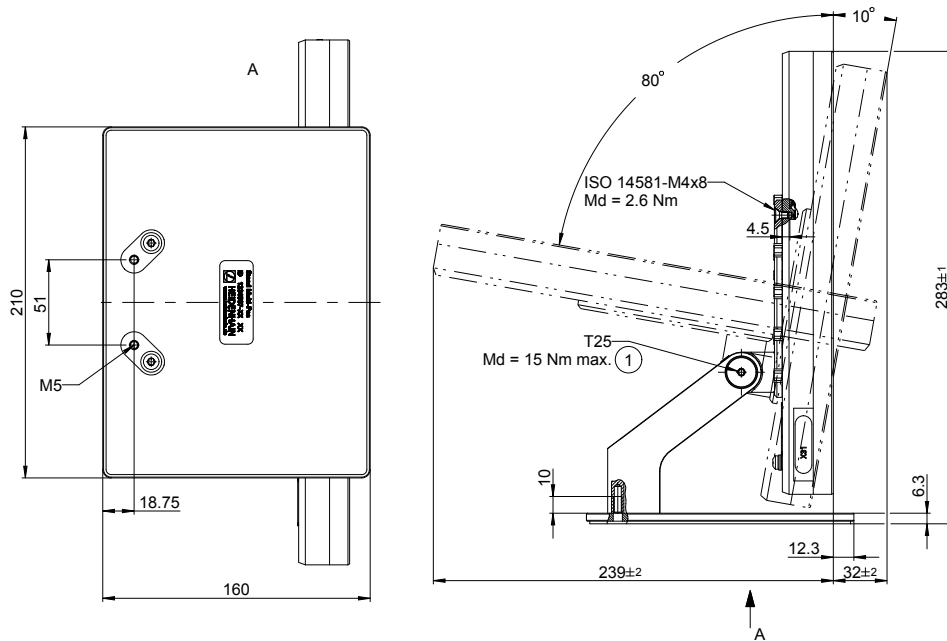

Figure 35: Product dimensions with Multi-Pos stand

10.3.4 Product dimensions with Multi-Pos holder

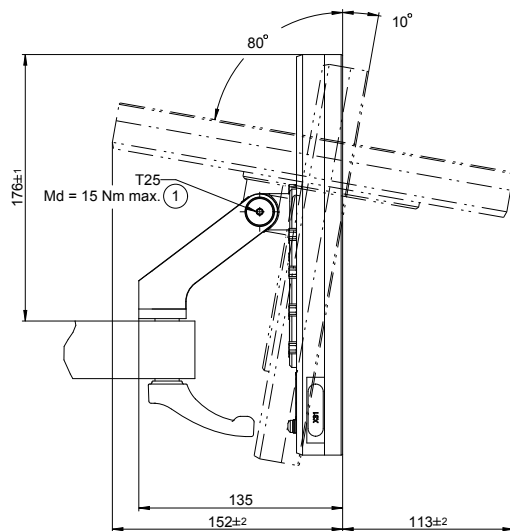

Figure 36: Product dimensions with Multi-Pos holder



**Information for the
Operator**

Overview

This part of the documentation contains important information for Operator-type users regarding the proper operation of the product.

This part of the documentation contains information on the individual operating modes:

- "Manual operation", Page 225
- "MDI mode", Page 234
- "Program run", Page 246
- "Programming", Page 255

You will also find an application example, information on servicing and maintenance as well as information on trouble-shooting:

- "Application example", Page 267
- "Servicing and Maintenance", Page 199
- "What to do if ...", Page 285

Contents of chapters in the "Information for the Operator" part

The table below shows:

- The chapters included in this "Information for the Operator" part
- The information contained in these chapters
- The target groups that these chapters are mainly intended for

Section	Contents	Target group		
		OEM	Setup	Operator
This chapter contains information about...				
1 "Manual operation"	... the "Manual" mode of operation ... using the "Manual" mode of operation		✓	✓
2 "MDI mode"	... the "MDI" mode of operation ... using the "MDI" mode of operation ... executing single blocks		✓	✓
3 "Program run"	... the "Program Run" mode of operation ... using the "Program Run" mode of operation ... executing previously created programs		✓	✓
4 "Programming"	... the "Program Run" mode of operation ... using the "Program Run" mode of operation ... executing previously created programs		✓	✓
5 "Application example"	... a typical manufacturing process based on a sample workpiece			✓
6 "What to do if ..."	... causes of faults or malfunctions of the product ... corrective actions for faults or malfunctions of the product	✓	✓	✓

Contents

1	Manual operation.....	225
1.1	Overview.....	226
1.2	Defining the upper limit for the spindle speed.....	227
1.3	Conducting the reference mark search.....	228
1.4	Defining presets.....	229
	1.4.1 Touching off presets.....	229
	1.4.2 Setting a position as a preset.....	230
1.5	Creating tools.....	231
1.6	Calibrating tools.....	232
1.7	Selecting a tool.....	232
1.8	Moving with jog increment.....	233
2	MDI mode.....	234
2.1	Overview.....	235
2.2	Defining the upper limit for the spindle speed.....	237
2.3	Block types.....	238
	2.3.1 Positioning.....	238
	2.3.2 Machining cycle.....	238
2.4	Executing blocks.....	241
2.5	Using the simulation window.....	242
	2.5.1 Depiction as contour view.....	243
2.6	Working with the positioning aid.....	244
2.7	Applying the Scaling factor.....	244
3	Program run.....	246
3.1	Overview.....	247
3.2	Using the program.....	248
	3.2.1 Running the program.....	250
	3.2.2 Proceeding to a specific program block.....	251
	3.2.3 Aborting program run.....	251
	3.2.4 Using the simulation window.....	251
	3.2.5 Applying the Scaling factor.....	253
	3.2.6 Setting the spindle speed.....	253
3.3	Managing programs.....	254
	3.3.1 Opening a program.....	254
	3.3.2 Closing a program.....	254
4	Programming.....	255
4.1	Overview.....	256
4.2	Block types.....	257
	4.2.1 Positioning.....	257
	4.2.2 Coordinate systems.....	257
	4.2.3 Machine functions.....	258
	4.2.4 Machining cycle.....	258
4.3	Creating a program.....	261
	4.3.1 Programming support.....	261
	4.3.2 Creating a program header.....	262
	4.3.3 Adding blocks.....	262

- 4.3.4 Deleting blocks..... 262
- 4.3.5 Saving a program..... 262
- 4.4 Using the simulation window..... 263
 - 4.4.1 Depiction as contour view..... 264
 - 4.4.2 Activating the simulation window..... 264
 - 4.4.3 Checking a program in the simulation window..... 265
- 4.5 Managing programs..... 265
 - 4.5.1 Opening a program..... 265
 - 4.5.2 Closing a program..... 265
 - 4.5.3 Saving a program..... 265
 - 4.5.4 Saving a program under a new name..... 265
 - 4.5.5 Saving a program automatically..... 266
 - 4.5.6 Deleting a program..... 266
- 4.6 Editing program blocks..... 266

5 Application example..... 267

- 5.1 Overview..... 268
- 5.2 Logging in for the application example..... 269
- 5.3 Requirements..... 269
- 5.4 Setting up the lathe..... 272
 - 5.4.1 Measuring the reference tool..... 273
 - 5.4.2 Tool measurement..... 274
 - 5.4.3 Finding the preset..... 275
- 5.5 Roughing the outside contour..... 275
- 5.6 Turning the recess..... 278
- 5.7 Turning the chamfer..... 279
- 5.8 Finishing the outside contour..... 279
- 5.9 Machining threads..... 282
 - 5.9.1 Defining threads..... 283
 - 5.9.2 Thread cutting..... 284

6 What to do if 285

- 6.1 Overview..... 286
- 6.2 Exporting logging files..... 286
- 6.3 System or power failure..... 286
 - 6.3.1 Restoring the firmware..... 287
 - 6.3.2 Restoring settings..... 287
- 6.4 Malfunctions..... 287
 - 6.4.1 Troubleshooting..... 288

1

Manual operation

1.1 Overview

This chapter describes the Manual operation mode and how to execute simple machining operations in this mode on a workpiece.

i Make sure that you have read and understood the "Basic Operation" chapter before carrying out the actions described below.
Further information: "Basic Operation", Page 19

Short description

By traversing the reference marks on the encoder scales, you make it possible to define an absolute position. When you have completed the reference mark search in Manual mode, you then set the presets that will be used as the basis for machining the workpiece in accordance with the drawing.

i Presetting in the Manual Operation mode is required in order to use the product in MDI mode.

i For encoders with EnDat interface, the reference mark search is omitted because the axes are referenced automatically.

Position measurement and tool selection for simple machining operations in Manual mode are described below.

Call



- ▶ Tap **Manual operation** in the main menu
- > The user interface for Manual operation appears.

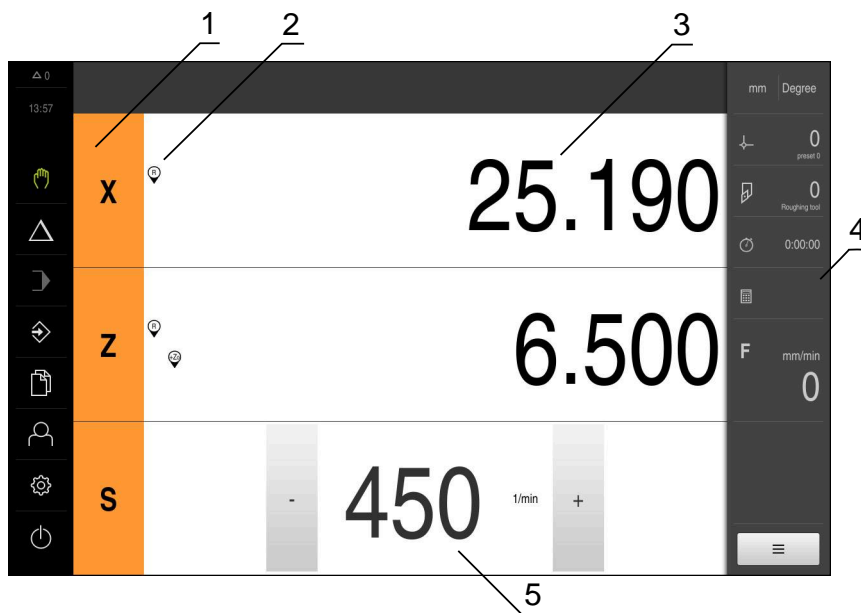

Figure 37: **Manual operation** menu

- 1 Axis key
- 2 Reference
- 3 Position display
- 4 Status bar
- 5 Spindle speed (machine tool)

1.2 Defining the upper limit for the spindle speed

If the product is configured with a **spindle axis S**, then you must define an upper limit for the spindle speed prior to a possible machining sequence.

For this purpose, the **Upper limit for spindle speed** appears every time the product is switched on.

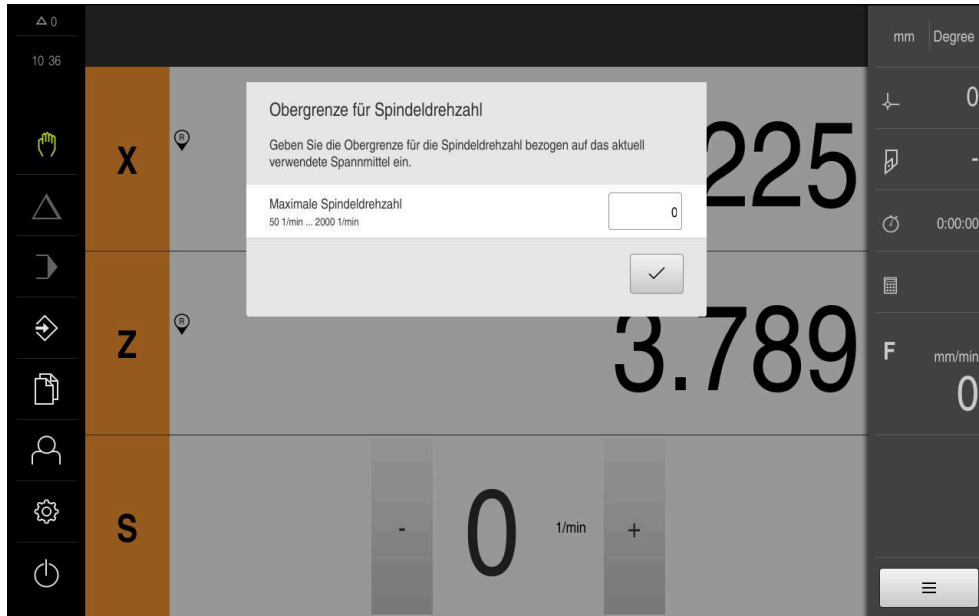

Figure 38: **Upper limit for spindle speed** dialog box

- ▶ Tap the **Maximum spindle speed** input field
- ▶ Enter the upper limit for the spindle speed with respect to the currently used clamping equipment
- ▶ Confirm your input with **RET**
- ▶ Tap **Confirm**
- ▶ The upper limit is now adopted by the product.
- ▶ The **Upper limit for spindle speed** dialog is closed.





1.3 Conducting the reference mark search

With the help of reference marks, the unit can assign axis positions of the encoder to the machine.

If no reference marks for the encoder are provided by a defined coordinate system, you need to perform a reference mark search before you start measuring.

 If the product is configured with a **spindle axis S**, then you must define an upper limit for the spindle speed prior to a possible machining operation.
Further information: "Defining the upper limit for the spindle speed", Page 227

 If the reference mark search after unit start is active, then all of the unit's functions will be disabled until the reference mark search has been successfully completed.
Further information: "Reference marks (Encoder)", Page 97

 For encoders with EnDat interface, the reference mark search is omitted because the axes are referenced automatically.

If the reference mark search is active on the unit, then a wizard will ask you to traverse the reference marks of the axes.

- ▶ After logging in, follow the instructions of the wizard
- > The Reference symbol stops blinking upon successful completion of the reference mark search.

Further information: "Operating elements of the position display", Page 40

Further information: "Activating the reference mark search", Page 140

Starting the reference mark search manually

If the reference mark search was not performed on startup, you can start it manually later.



- ▶ Tap **Manual operation** in the main menu
- > The user interface for Manual operation appears.



- ▶ Tap **Auxiliary functions** in the status bar



- ▶ Tap **Reference marks**
- > Existing reference marks are cleared.
- > The Reference icon blinks.
- ▶ Follow the instructions of the wizard
- > The Reference symbol stops blinking upon successful completion of the reference mark search.

1.4 Defining presets

You can define presets on a workpiece in the Manual Operation mode in the following ways:

- Probing a workpiece with a tool (touch-off). Use this method to define the respective tool position as a datum.
- Move to the position and set it as a preset, or overwrite position value



The setup engineer (**Setup**) may have already made settings in the datum table.

Further information: "Creating a preset table", Page 169



When touching the workpiece with a tool, the product uses the parameters stored in the tool table.

Further information: "Creating a tool table", Page 167

Requirement:

- A workpiece is clamped on the machine tool
- The axes have been homed

1.4.1 Touching off presets



- ▶ Tap **Manual operation** in the main menu
- > The user interface for Manual operation appears.



- ▶ Tap **Auxiliary functions** in the status bar



- ▶ Tap **Presets** in the dialog box
- > The **Set preset data** dialog box opens.
- ▶ Move the tool to the desired position



- ▶ Tap **Save position**
- > The current position of the tool is saved.
- ▶ Retract the tool to a safe position
- ▶ Enter the desired position data in the input fields



- ▶ Tap **Confirm** in the wizard
- > The dialog Select preset opens.
- ▶ Select the desired preset in the **Selected preset** input field:
 - ▶ To overwrite an existing preset, select an entry from the preset table
 - ▶ To create a new preset, enter a number that has not yet been assigned in the preset table and confirm with **RET**



- ▶ Tap **Confirm** in the wizard
- > The probed coordinates are adopted as the preset.

1.4.2 Setting a position as a preset

For simple machining operations, you can use the current position as a preset and perform simple position calculations.

Prerequisite:

- A workpiece is clamped on the machine tool
- The axes are referenced

i In a system with reference marks, zeroing and presetting are only possible after a reference run has been performed.

After a restart of the device, it would not be possible to determine the position of the presets without such a reference. In addition, the preset table would lose its validity without referencing, since it would not be possible to approach the stored points correctly.

Further information: "Conducting the reference mark search", Page 228

i If you use the axis label X for direct input, the current preset will be shifted. As a result, the center point will be displaced from the center of the spindle. Direct input via axis label X can be disabled or enabled.

Further information: "Diameter axis", Page 137

Setting the current position as preset



- ▶ Approach the desired position
- ▶ Long-press the **axis key**
- > The active preset in the preset table is overwritten with the current position.
- > The active preset is applied as the new value.
- ▶ Perform the desired machining operation

Defining the position values of the current position



- ▶ Approach the desired position
- ▶ In the working space, tap the **axis key** or the position value
- ▶ Enter the desired position value
- ▶ Confirm the entry with **RET**
- > The position value is applied to the current position.
- > The entered position value is linked with the current position and overwrites the active preset in the preset table.
- > The active preset is applied as the new value.
- ▶ Perform the desired machining operation

1.5 Creating tools

In the Manual Operation mode, you can enter the tools you want to use into the tool table.



The setup engineer (**Setup**) may have already made the settings in the tool table.

Further information: "Creating a tool table", Page 167

- A workpiece is clamped on the machine tool
- The axes have been homed



- ▶ Tap **Tools** on the status bar
- > The **Tools** dialog box appears.



- ▶ Tap **Open table**
- > The **Tool table** dialog box appears.



- ▶ Tap **Add**
- ▶ Enter a name in the **Tool type** input field
- ▶ Confirm the entry with **RET**
- ▶ Tap the input fields one after the other, and enter the corresponding values
- ▶ Change the unit of measure in the selection menu, if required
- > The entered values are converted.
- ▶ Confirm the entry with **RET**
- > The defined tool is added to the tool table.



- ▶ To protect the entry for a tool from accidental changes or deletion, tap the **Lock** symbol next to the tool's entry



- > The icon changes and the entry is locked.



- ▶ Tap **Close**
- > The **Tool table** dialog is closed.

1.6 Calibrating tools

In order to determine the tool coordinates **X** and **Z** and store them in the tool table, you can calibrate the tool with the **Set tool data** function on the lathe



- ▶ Tap **Manual operation** in the main menu
- > The user interface for Manual operation appears.



- ▶ Tap **Auxiliary functions** in the status bar



- ▶ Tap **Tool data** in the dialog box
- > The **Set tool data** dialog box opens.
- ▶ Move the tool to the desired position



- ▶ Tap **Save position**
- > The current position of the tool is saved.
- ▶ Retract the tool to a safe position
- ▶ Enter the desired position data in the input fields



- ▶ Tap **Confirm** in the wizard
- > The **Select the tool** dialog box appears.
- ▶ Select the desired tool in the **Selected tool** input field:
 - ▶ To overwrite an existing tool, select an entry from the tool table
 - ▶ To add a new tool, enter a number that has not yet been assigned in the tool table and confirm by pressing **RET**



- ▶ Tap **Confirm** in the wizard
- > The probed coordinates are adopted for the tool.

1.7 Selecting a tool

The currently selected tool is displayed on the status bar. Here you can also access the tool table where you can select the tool you want to use. The associated tool parameters are applied automatically.



The setup engineer (**Setup**) may have already made the settings in the tool table.

Further information: "Creating a tool table", Page 167



- ▶ Tap **Tools** on the status bar
- > The **Tools** dialog box appears.
- ▶ Tap the tool you want to use



- ▶ Tap **Confirm**
- > The associated tool parameters are applied automatically.
- > The selected tool is shown on the status bar.
- ▶ Mount the desired tool on the machine tool

1.8 Moving with jog increment

In Manual mode you can traverse incrementally with the Jog increment function.



- ▶ Tap **Feed rate/Jog increment** on the status bar
- > The **Feed rate/Jog increment** dialog box appears.
- ▶ Activate the jog increment with the **ON/OFF** slide switch
- ▶ Enter the jog increment in the corresponding input field
 - For linear axes, use the input fields for **mm/rev** and **mm/min**
 - For rotational axes, use the **jog increment °** input field



- ▶ Tap **Close** to close the dialog
- > The axes can be moved at the entered jog-increment value.



- > If jog increment is activated, this is shown by an icon

2

MDI mode

2.1 Overview

This chapter describes the Manual Data Input (MDI) operating mode and how to execute machining steps in single blocks in this mode.

 Make sure that you have read and understood the "Basic Operation" chapter before carrying out the actions described below.
Further information: "Basic Operation", Page 19

Short description

MDI mode allows you to execute one machining block at a time. The values to be entered can be applied directly in the input field from a properly dimensioned production drawing.

 Before you can use the product in the MDI mode, the presets must be set in the Manual Operation mode.
Further information: "Defining presets", Page 229

The functions provided by MDI mode enable efficient single-part production. For small-batch production, you can program the machining steps in Programming mode and then execute them in Program Run mode.

Further information: "Programming", Page 255

Further information: "Program run", Page 246

Activation



- ▶ Tap **MDI** in the main menu



- ▶ Tap **Create** on the status bar
- ▶ The user interface for MDI mode is displayed.

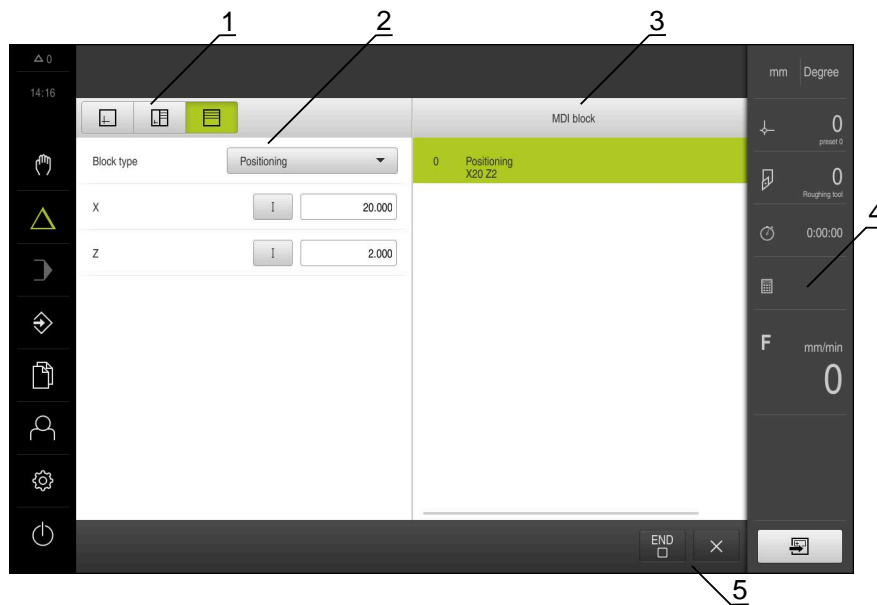

Figure 39: **MDI** menu

- 1 View bar
- 2 Block parameters
- 3 MDI block
- 4 Status bar
- 5 Block tools

2.2 Defining the upper limit for the spindle speed

If the product is configured with a **spindle axis S**, then you must define an upper limit for the spindle speed prior to a possible machining sequence.

For this purpose, the **Upper limit for spindle speed** appears every time the product is switched on.

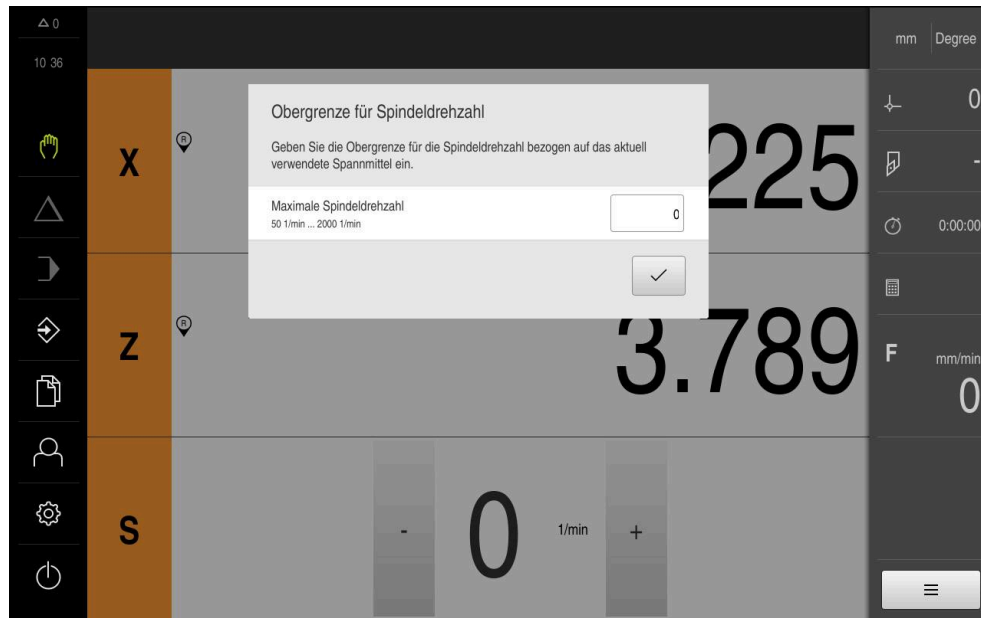

Figure 40: **Upper limit for spindle speed** dialog box

- ▶ Tap the **Maximum spindle speed** input field
- ▶ Enter the upper limit for the spindle speed with respect to the currently used clamping equipment
- ▶ Confirm your input with **RET**
- ▶ Tap **Confirm**
- ▶ The upper limit is now adopted by the product.
- ▶ The **Upper limit for spindle speed** dialog is closed.



2.3 Block types

You can use the following block types for machining in the MDI mode:

- Positioning functions
- Machining cycle

2.3.1 Positioning

You can manually define position values for positioning. Depending on the configuration of the connected machine tool, you can then move the tool to these positions either automatically or manually.

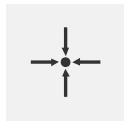

Actual position

Applies the current axis position or current spindle speed to the input fields of the various block types

The following parameters are available:

Positioning block type

Parameter	Description
	Incremental position value, i.e. the position value is referenced to the actual position

2.3.2 Machining cycle

If the lathe is configured for thread cutting, two machining cycles are available. Thread cutting (basic) allows you to execute a simple thread cut without downfeed. Thread cutting (extended) allows you to define an extended thread cycle with downfeed.



Before defining a machining pattern, you must

- Define a suitable tool in the tool table
- Select the tool on the status bar

Further information: "Creating a tool table", Page 167

Thread cutting (basic) block

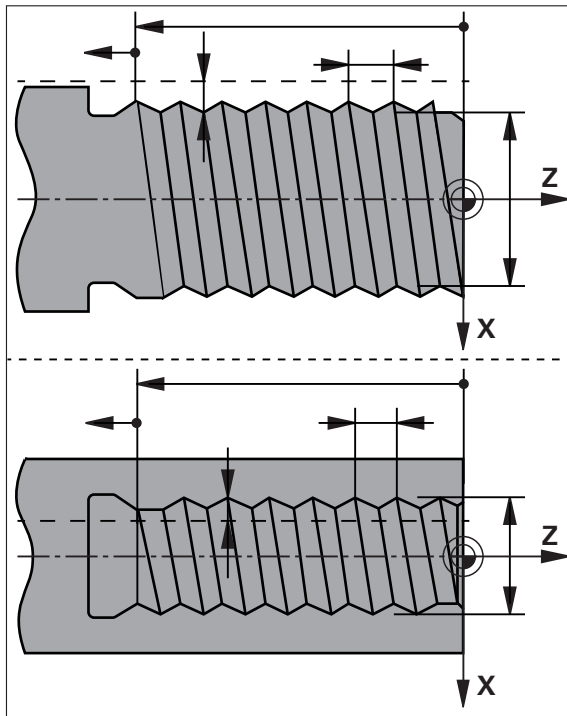





Figure 41: Schematic depiction of the **Thread cutting (basic)** block

Parameter	Description
Thread position 	Position of the thread <ul style="list-style-type: none"> ■ External thread ■ Internal thread
Direction of rotation 	Direction of rotation of the rotational axis <ul style="list-style-type: none"> ■ Right ■ Left
Safety clearance	Incremental to the thread depth, radial dimension
Thread depth (diameter)	Thread depth, diameter dimension
Thread pitch 	Pitch of the thread <ul style="list-style-type: none"> ■ In mm ■ In threads per inch
Contour start in Z	Start of the thread in Z
Contour end in Z	End of the thread in Z
Overrun	Path at the end of thread for stopping the axes
Starting angle	Entrance angle in the rotational axis
Rotational speed	Rotational speed in rpm
Feed rate in X	Feed rate for downfeed to thread depth

Thread cutting block (extended)

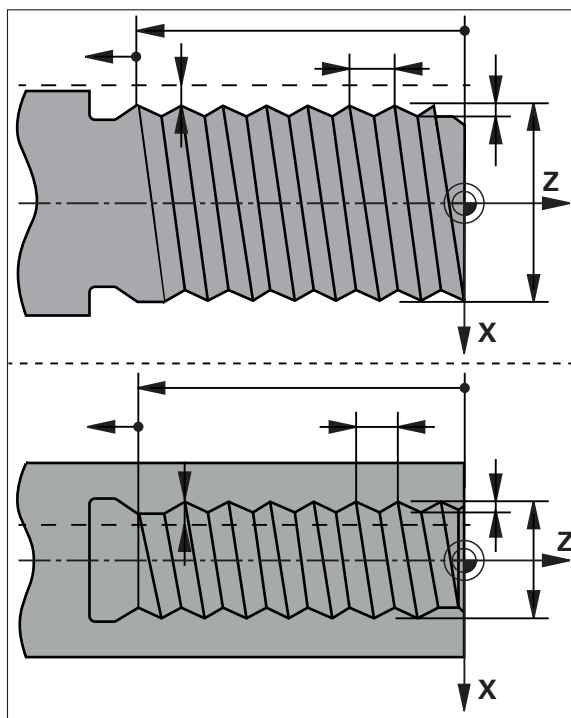

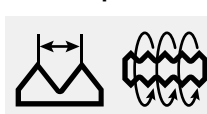

Figure 42: Schematic depiction of the **Thread cutting (extended)** block

Parameter	Description
Thread position 	Position of the thread <ul style="list-style-type: none"> ■ External thread ■ Internal thread
Direction of rotation 	Direction of rotation of the rotational axis <ul style="list-style-type: none"> ■ Right ■ Left
Safety clearance X	Incremental to the thread diameter, radial dimension
Thread diameter	Rated diameter of thread (diameter dimension)
Thread depth	Incremental to the thread diameter, radial dimension
Finishing allowance	Finishing allowance for downfeed, radial dimension
Thread pitch 	Pitch of the thread <ul style="list-style-type: none"> ■ In mm ■ In threads per inch
Contour start in Z	Start of the thread in Z
Contour end in Z	End of the thread in Z
Overrun	Path at the end of thread for stopping the axes
Starting angle	Entrance angle in the rotational axis
Rotational speed	Rotational speed in rpm

Parameter	Description
Feed rate in X	Feed rate for downfeed to thread depth
Air cuts	Number of air cuts at the end (0 – 10)

2.4 Executing blocks

You can execute a positioning function and execute this block.



If enabling signals are missing, the running program is halted and the drives of the machine are stopped.

Further information: Manufacturer's documentation for the machine

Executing blocks



- ▶ Tap **Create** on the status bar
- > A new block is displayed
or
- > The last programmed MDI block is loaded along with all of its parameters.
- ▶ Select the desired block type from the **Block type** drop-down list



- ▶ Based on the block type, define the relevant parameters
- ▶ To load the current axis position, tap **Actual position capture** in the appropriate input fields
- ▶ Confirm each input with **RET**



- ▶ To execute the block, tap **END**
- > The positioning aid is displayed.
- > If the simulation window is activated, the current block is visualized.
- > Depending on the block, user intervention may be required; the wizard will display the relevant instructions.



- ▶ Follow the instructions in the wizard
- ▶ If you are using NC-controlled axes, then tap or press **NC START** on the product or machine tool



- ▶ In multi-step blocks, such as machining patterns, tap **Next** to jump to the next instruction

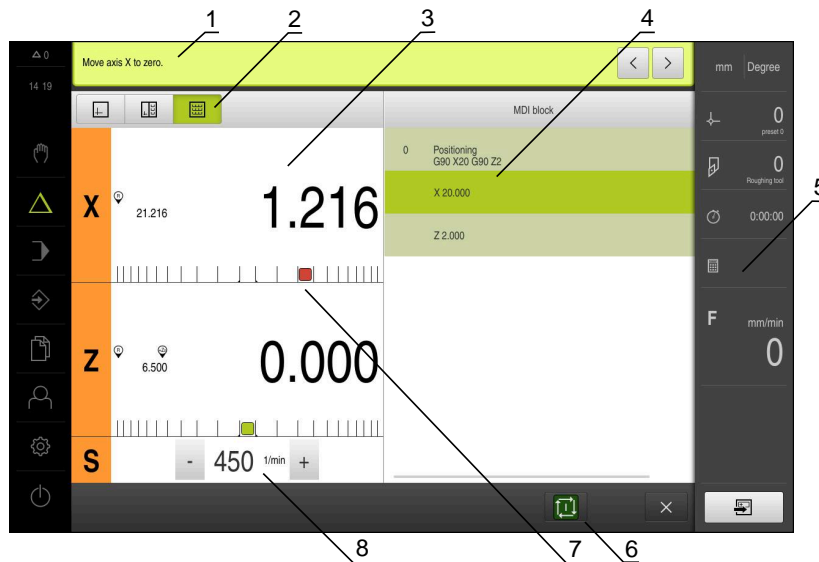

Figure 43: Example of a block in **MDI** mode

- 1 Wizard
- 2 View bar
- 3 Distance-to-go display
- 4 MDI block
- 5 Status bar
- 6 NC START key
- 7 Positioning aid
- 8 Spindle speed (machine tool)

2.5 Using the simulation window

You can display a visualization of the selected block in the optional simulation window.

The following options are available on the view bar:

Operating element	Function
	Graphic Display of simulation and blocks
	Graphic-Position Display of simulation, parameters (position values for program run, if required) and blocks
	Position Display of parameters (position values for program run, if required) and blocks

2.5.1 Depiction as contour view

The simulation window displays a contour view. The contour view aids in the precise positioning of the tool or with contour tracking in the machining plane.

The contour view uses the following colors (defaults):

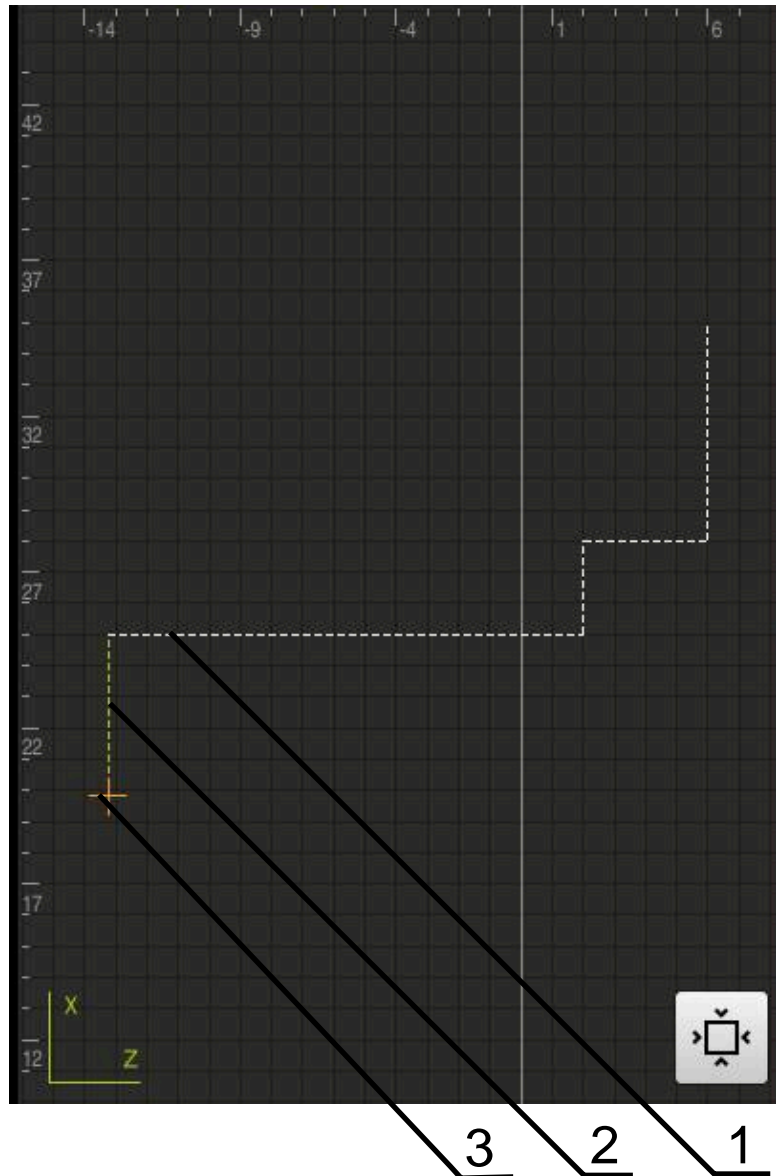

Figure 44: Simulation window with contour view

- 1 Machining pattern (white)
- 2 Current block or machining position (green)
- 3 Tool contour, tool position and tool track (orange)

Activating the simulation window



- ▶ Tap **Graphic-Position**
- > The simulation window for the currently selected block appears.



- ▶ Tap **Graphic** on the view bar to enlarge the simulation window
- > The parameter view is hidden and the simulation window is enlarged.

2.6 Working with the positioning aid

During positioning to the next nominal position, the product assists you by displaying a graphic positioning aid ("traversing to zero"). A scale is shown underneath each axis you traverse to zero. The graphic positioning aid is a small square that symbolizes the target position of the tool.

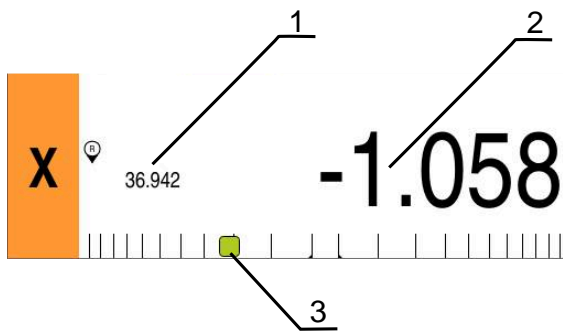

Figure 45: **Distance to go with position** view with graphical positioning aid

- 1 Actual value
- 2 Distance-to-go
- 3 Positioning aid

The positioning aid moves across the measuring scale when the tool center is located within a range of ± 5 mm of the nominal position. The color also changes in the following way:

Display of positioning aid	Meaning
Red	The tool center is moving away from the nominal positions
Green	The tool center is moving toward the nominal position

2.7 Applying the Scaling factor

If a scaling factor is activated for one or more axes, this scaling factor is multiplied by the stored nominal position during execution of a block. This enables you to mirror and scale a block.

You can activate a scaling factor in the quick access menu.

Further information: "Adjusting settings in the quick access menu", Page 46

Example:

The following **MDI block** is programmed:

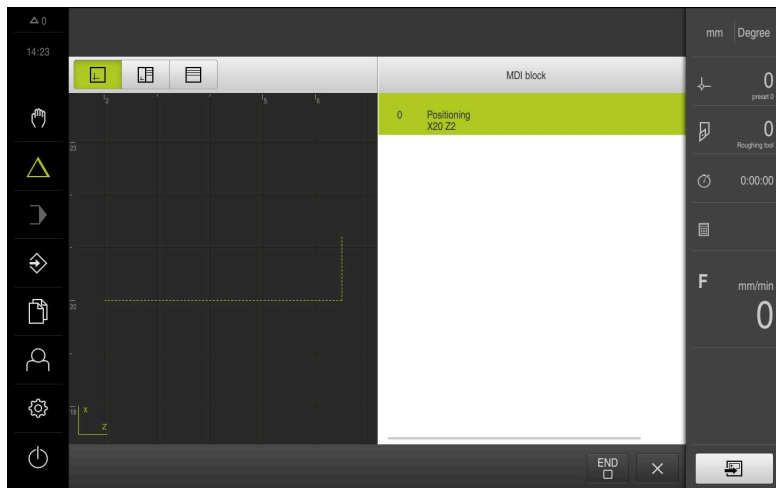

Figure 46: Example – MDI block

A **Scaling factor** of **-0.5** is activated for the **X** axis. The following **MDI block** will therefore be executed:

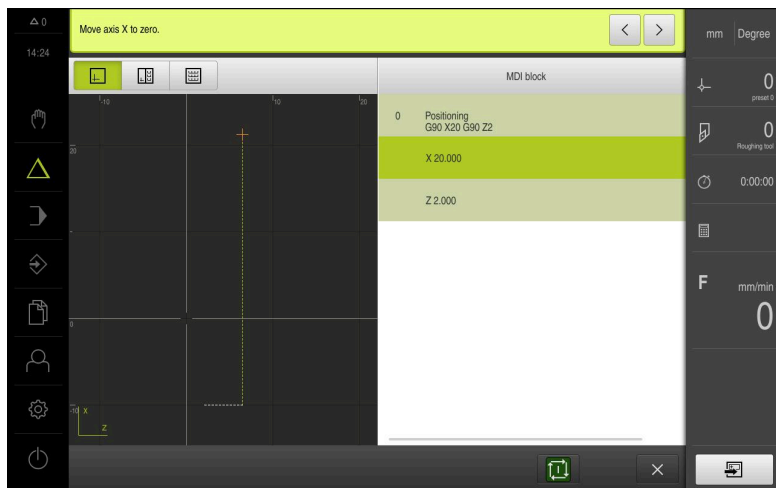

Figure 47: Example – Execution of an MDI block with scaling factor



If the calculated dimensions cannot be attained with the selected tool, the execution of the block is aborted.



The scaling factor cannot be changed during execution of a block.

3

Program run

3.1 Overview

This chapter describes the Program Run operating mode and how to execute a previously created program in this mode.



Make sure that you have read and understood the "Basic Operation" chapter before carrying out the actions described below.

Further information: "Basic Operation", Page 19

Short description

In the Program Run operating mode, you use an already created program for part production. It is not possible to change the program in this operating mode, but you can check it in Single Block mode when running the program.

Further information: "In Single block mode", Page 250

The execution of the program run may vary depending on the machine tool and the product version:

- If the machine tool has NC-controlled axes, and the product uses a POSITIP 8000 NC1 software option, then the parameters for positioning movements are transferred directly to the machine tool. The individual steps are initiated via the NC START key on the machine tool.
- If the machine tool does not have any NC-controlled axes, then you must perform the positioning movements manually using the handwheel or the manual direction key.

During execution of a program, the wizard guides you through the individual program steps. The optional simulation window can serve as a graphical positioning aid for the axes you need to move.

Call

- ▶ Tap **Program run** in the main menu
- The user interface for Program Run is displayed.



- 1 View bar
- 2 Status bar
- 3 Program control
- 4 Spindle speed (machine tool)
- 5 Program management



If the **Z** axis and the **Zo** axis have been coupled, the Program run operating mode is disabled.

3.2 Using the program

The product displays a loaded program with the blocks and, when applicable, with the individual working steps of the blocks.



If enabling signals are missing, the running program is halted and the drives of the machine are stopped.

Further information: Manufacturer's documentation for the machine

Requirement:

- The appropriate workpiece and tool have been clamped
- A program *.i file type has been loaded

Further information: "Managing programs", Page 254

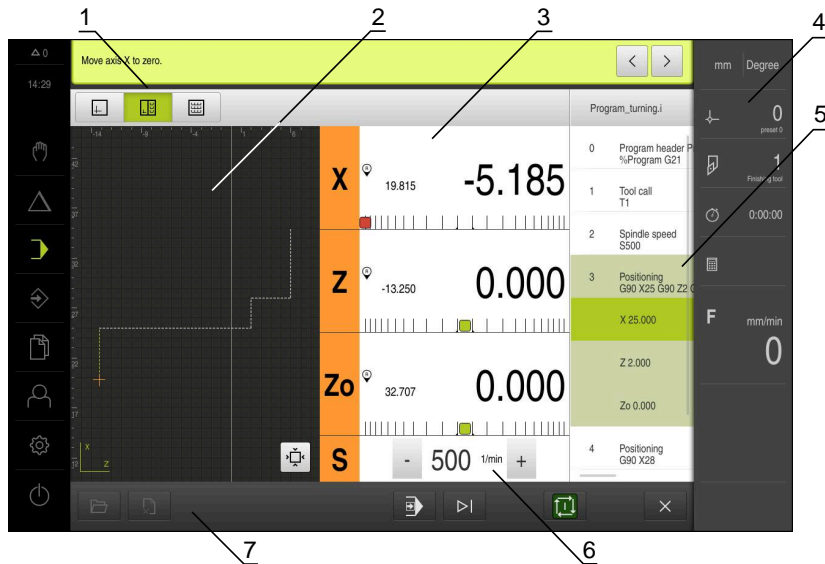



Figure 48: Example of a program in the **Program run** operating mode

- 1 View bar
- 2 Simulation window (optional)
- 3 Distance-to-go display
- 4 Toolbar
- 5 Program blocks
- 6 Spindle speed (machine tool)
- 7 Program management

3.2.1 Running the program

With NC-controlled axes and software option POSITIP 8000 NC1

 If the program does not contain a **Feed rate** block, the product uses the feed rate value "0."

- ▶ Press the NC START key on the machine tool
- The product selects the first block of the program.
- ▶ Press the NC START key on the machine tool again
- User intervention may be required, depending on the block. The wizard shows the appropriate instruction. With a tool call, for example, the spindle is automatically stopped and you are requested to change the corresponding tool.
- ▶ With multi-step blocks, such as machining patterns, tap **Next** to proceed to the next step in the wizard
- ▶ Follow the wizard's instructions for the block



 Blocks that do not require any action by the user (such as presetting) are executed automatically.

- ▶ Press the NC START key to execute the next block, and continue in this manner until the end of the program

With manual machine tools



- ▶ Tap **NC START** on the program control
- The product selects the first block of the program.
- ▶ Tap **NC START** on the program control once again
- User intervention may be required, depending on the block. The wizard shows the appropriate instruction. With a tool call, for example, the spindle is automatically stopped and you are requested to change the corresponding tool.
- ▶ With multi-step blocks, such as machining patterns, tap **Next** to proceed to the next step in the wizard
- ▶ Follow the wizard's instructions for the block



 Blocks that do not require any action by the user (such as presetting) are executed automatically.



- ▶ Tap **NC START** to execute the next block, and continue in this manner until the end of the program

In Single block mode



- ▶ Tap **Single block** on the program control to activate Single Block mode
- When the Single Block mode is active, the program stops after each block of the program control (this also includes blocks that do not require any action by the user).

3.2.2 Proceeding to a specific program block

To go to a specific block, you can skip blocks one by one within a program until you reach the desired block. It is not possible to jump back in the program.



- ▶ Tap **Next program step** on the program control
- > The next block is selected.

3.2.3 Aborting program run

If errors or problems occur, you can abort the execution of a program. The tool position and the spindle speed remain unchanged when the program run is aborted.



The program run cannot be aborted if the current block is executing a traverse motion.





- ▶ Tap **Stop program** in the program management
- > The program run is aborted.

3.2.4 Using the simulation window

You can display a visualization of the selected block in the optional simulation window.

The following options are available on the view bar:

Operating element	Function
	Graphic Display of simulation and blocks
	Graphic-Position Display of simulation, position values and blocks
	Position Display of position values and blocks

Depiction as contour view

The simulation window displays a contour view. The contour view aids in the precise positioning of the tool or with contour tracking in the machining plane.

The contour view uses the following colors (defaults):

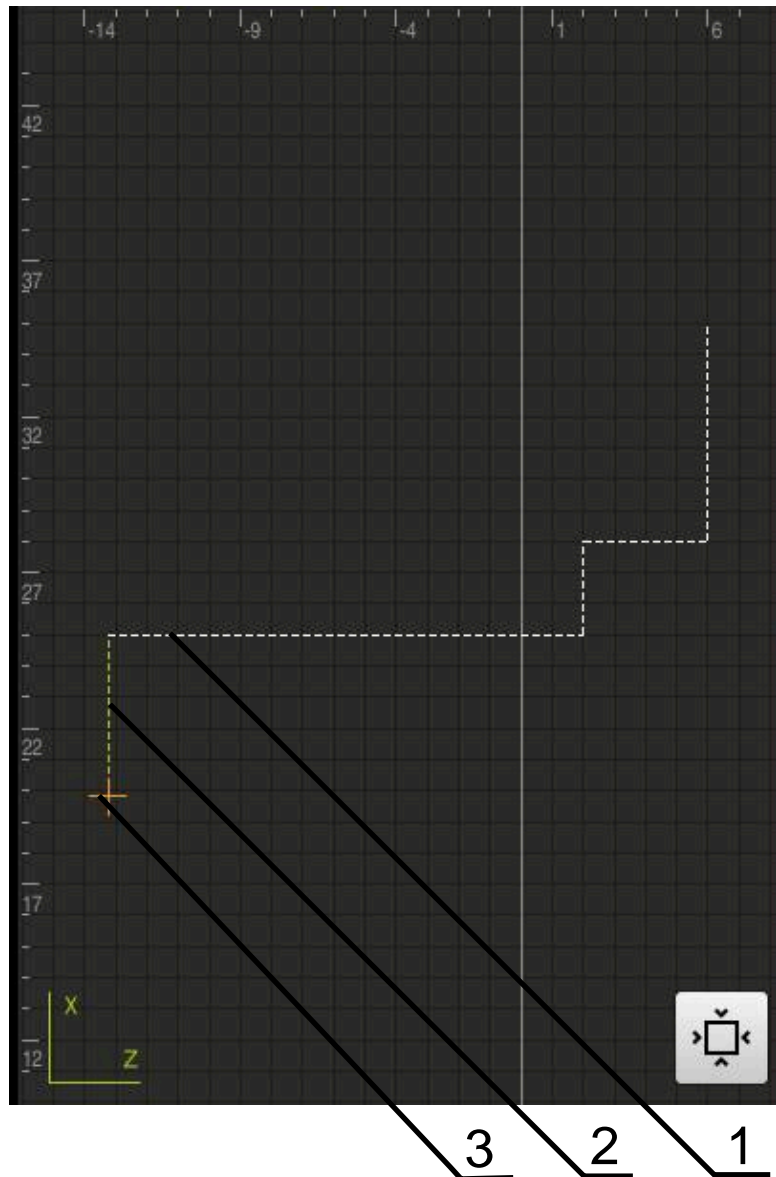

Figure 49: Simulation window with contour view

- 1 Machining pattern (white)
- 2 Current block or machining position (green)
- 3 Tool contour, tool position and tool track (orange)



You can modify the colors and line thicknesses used in the contour view.

Further information: "Simulation window", Page 185

Activating the simulation window



- ▶ Tap **Graphic-Position**
- > The simulation window for the currently selected block appears.



- ▶ Tap **Graphic** on the view bar to enlarge the simulation window
- > The parameter view is hidden and the simulation window is enlarged.

Modifying the contour view



- ▶ Tap **Detail view**
- > The detail view shows the tool path and the possible machining positions for the currently selected block.



- ▶ Tap **Overview**
- > The overview shows the entire workpiece.

3.2.5 Applying the Scaling factor

If a scaling factor is activated for one or more axes, this scaling factor is multiplied by the stored nominal position during execution of a block. This enables you to mirror and scale a block.

You can activate a scaling factor in the quick access menu.

Further information: "Adjusting settings in the quick access menu", Page 46



If the calculated dimensions cannot be attained with the selected tool, the execution of the block is aborted.



The scaling factor cannot be changed during execution of a block.

3.2.6 Setting the spindle speed

You can control the spindle speed depending on the configuration of the connected machine tool.

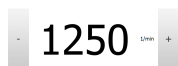

- ▶ To switch from the display of the spindle speed to the input field (if required), drag the display to the right.
- > The **Spindle speed** input field is displayed.
- ▶ Tap or long-press **+** or **-** to set the spindle speed to the desired value
- or
- ▶ Tap the **Spindle speed** input field
- ▶ Enter the desired value
- ▶ Confirm entry with **RET**
- > The product applies the entered spindle speed as the nominal value and controls the spindle of the machine tool accordingly.
- ▶ To return to the display of the actual spindle speed, drag the input field to the left



3.3 Managing programs

To run a program, open the program file, which must be of the *.i type.



The default storage location for programs is **Internal/Programs**.

3.3.1 Opening a program



- ▶ Tap **Open program** in the program management
- ▶ Select the storage location in the dialog, e. g. **Internal/Programs** or USB mass storage device
- ▶ Tap the folder containing the file
- ▶ Tap the file
- ▶ Tap **Open**
- > The selected program is loaded.

3.3.2 Closing a program



- ▶ Tap **Close program** in the program management
- > The opened program is closed.

4

Programming

4.1 Overview

This chapter describes the Programming operating mode and how to create new programs and edit existing programs in this mode.

i Make sure that you have read and understood the "Basic Operation" chapter before carrying out the actions described below.
Further information: "Basic Operation", Page 19

Short description

The product uses programs for recurring tasks. Programs are created by defining various blocks, such as positioning functions or machine functions. A sequence of multiple blocks then forms a program. You can save a maximum of 100 blocks within a program.

i Programming does not require connecting the product to a machine tool.

i To obtain a better overview during programming, you can use the POSITIP 8000 Demo software for programming. You can export the generated programs and load them onto the device.

Activation



- ▶ Tap **Programming** in the main menu
- > The user interface for programming is displayed.



Figure 50: **Programming** menu

- 1 View bar
- 2 Toolbar
- 3 Program management

i The status bar and the optional OEM bar are not available in the **Programming** menu.

4.2 Block types

You can use the following block types for programming:

- Positioning functions
- Change of coordinate system (preset)
- Machine functions
- Machining cycle

4.2.1 Positioning

You can manually define position values for positioning. Depending on the configuration of the connected machine tool, you can then move the tool to these positions either automatically or manually.

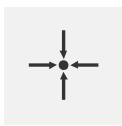

Actual position

Applies the current axis position or current spindle speed to the input fields of the various block types

The following parameters are available:

Positioning block type

Parameter	Description
	Incremental position value, i.e. the position value is referenced to the actual position

4.2.2 Coordinate systems

To change a coordinate system, you can call presets from the preset table. The coordinate system of the selected preset will then be used after the call.

Further information: "Setting a position as a preset", Page 230

Preset block type

Parameter	Description
	ID from the preset table Optional: Selection from preset table

4.2.3 Machine functions

You can call machine functions to machine the workpiece.

The available functions depend on the configuration of the connected machine tool. The following blocks and parameters are available:

Block type	Parameter / Description
Spindle speed	Rotational speed of the tool spindle
Feed rate	Speed of the tool axis (only for an NC-controlled axis)
	<div style="border: 1px solid black; padding: 5px;">  If the program does not contain a Feed rate block, the product uses the feed rate value "0." </div>
Cutting speed	Cutting speed of the turning tool
Tool call	Number of the tool Optional: Selection from tool table Further information: "Selecting a tool", Page 232 When a tool call is run, the spindle is automatically stopped and the user is requested to load the corresponding tool.
M function	Number of the M function Optional: Selection from function table
Dwell time	Time interval between machining steps

4.2.4 Machining cycle

If the lathe is configured for thread cutting, two machining cycles are available. Thread cutting (basic) allows you to execute a simple thread cut without downfeed. Thread cutting (extended) allows you to define an extended thread cycle with downfeed.

 Before defining a machining pattern, you must

- Define a suitable tool in the tool table
- Select the tool on the status bar

Further information: "Creating a tool table", Page 167

Thread cutting (basic) block

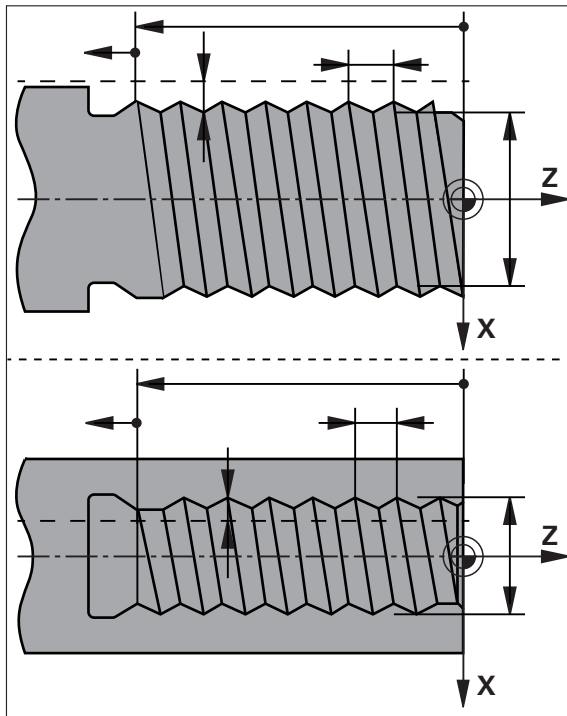





Figure 51: Schematic depiction of the **Thread cutting (basic)** block

Parameter	Description
Thread position 	Position of the thread <ul style="list-style-type: none"> ■ External thread ■ Internal thread
Direction of rotation 	Direction of rotation of the rotational axis <ul style="list-style-type: none"> ■ Right ■ Left
Safety clearance	Incremental to the thread depth, radial dimension
Thread depth (diameter)	Thread depth, diameter dimension
Thread pitch 	Pitch of the thread <ul style="list-style-type: none"> ■ In mm ■ In threads per inch
Contour start in Z	Start of the thread in Z
Contour end in Z	End of the thread in Z
Overrun	Path at the end of thread for stopping the axes
Starting angle	Entrance angle in the rotational axis
Rotational speed	Rotational speed in rpm
Feed rate in X	Feed rate for downfeed to thread depth

Thread cutting block (extended)

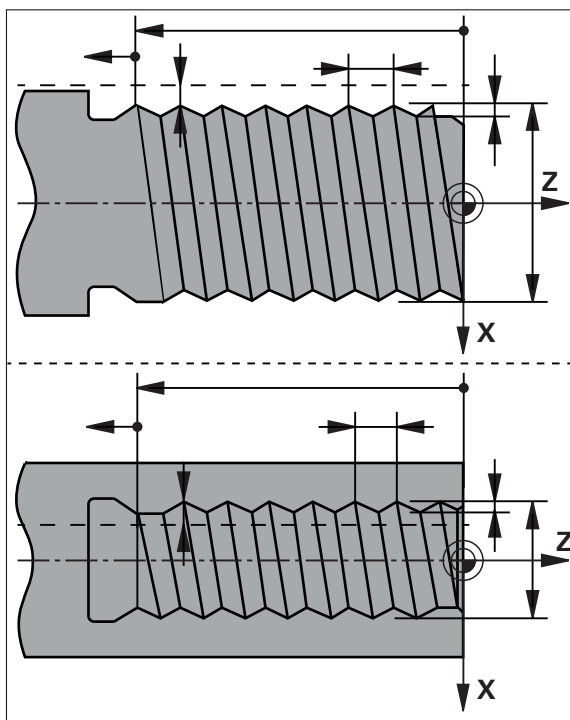





Figure 52: Schematic depiction of the **Thread cutting (extended)** block

Parameter	Description
Thread position 	Position of the thread <ul style="list-style-type: none"> ■ External thread ■ Internal thread
Direction of rotation 	Direction of rotation of the rotational axis <ul style="list-style-type: none"> ■ Right ■ Left
Safety clearance X	Incremental to the thread diameter, radial dimension
Thread diameter	Rated diameter of thread (diameter dimension)
Thread depth	Incremental to the thread diameter, radial dimension
Finishing allowance	Finishing allowance for downfeed, radial dimension
Thread pitch 	Pitch of the thread <ul style="list-style-type: none"> ■ In mm ■ In threads per inch
Contour start in Z	Start of the thread in Z
Contour end in Z	End of the thread in Z
Overrun	Path at the end of thread for stopping the axes
Starting angle	Entrance angle in the rotational axis
Rotational speed	Rotational speed in rpm

Parameter	Description
Feed rate in X	Feed rate for downfeed to thread depth
Air cuts	Number of air cuts at the end (0 – 10)

4.3 Creating a program

A program always consists of a program header and a sequence of blocks. You can define various block types, edit the associated block parameters, and delete individual blocks from the program.

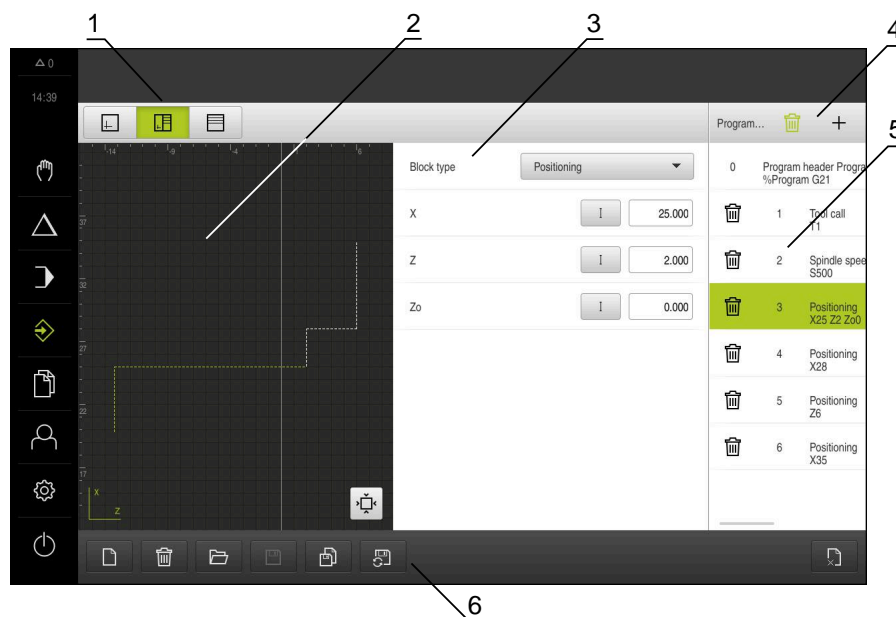

Figure 53: Example of a program in the **Programming** operating mode

- 1 View bar
- 2 Simulation window (optional)
- 3 Block parameters
- 4 Toolbar
- 5 Program blocks
- 6 Program management

4.3.1 Programming support

The product provides the following features to assist you in creating programs:

- When you add a block, the wizard displays information on the parameters that are required for the selected block type.
- If a block contains errors or undefined parameters, it is displayed in red type in the list.
- If problems occur, the wizard displays the message **The program contains incomplete program blocks**. You can switch between program blocks by tapping the arrow keys.
- The optional simulation window shows a visualization of the current block.
Further information: "Using the simulation window", Page 242



All changes to a program can be automatically saved.

- ▶ Tap **Save program automatically** in the program management
- ▶ All changes will be automatically saved immediately

4.3.2 Creating a program header



- ▶ Tap **Create new program** in the program management
- ▶ In the dialog select the storage location, e.g. **Internal/Programs**, in which you want to save the program
- ▶ Enter a name for the program
- ▶ Confirm the entry with **RET**
- ▶ Tap **Create**
- > A new program containing the **Program header** start block is created.
- > The name of the program is displayed on the toolbar.
- ▶ Enter a unique name in the **Name** field
- ▶ Confirm the entry with **RET**
- ▶ Change the unit of measure with the slide switch, if required

4.3.3 Adding blocks



- ▶ Tap **Add block** on the toolbar
- > A new block is inserted below the current position.
- ▶ Select the desired block type from the **Block type** drop-down list
- ▶ Define the relevant parameters, depending on the block type
Further information: "Block types", Page 257
- ▶ Confirm each entry with **RET**
- > If the simulation window is activated, the current block is visualized.

4.3.4 Deleting blocks



- ▶ Tap **Delete** on the toolbar
- > The blocks contained in the program are marked with a Delete symbol.
- ▶ Tap the Delete symbol for the blocks you want to delete in the program
- > The selected blocks are deleted from the program.
- ▶ Tap **Delete** on the toolbar again

4.3.5 Saving a program





- ▶ Tap **Save program** in the program management
- > The program is saved.

4.4 Using the simulation window

The simulation window visualizes the selected block. You can also use the simulation window to check a created program step by step.

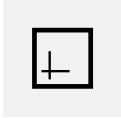
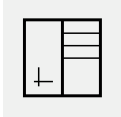
The following options are available on the view bar:

Control	Function
	Graphic Display of simulation and blocks
	Graphic position Display of simulation, position values, and blocks
	Position Display of position values and blocks

4.4.1 Depiction as contour view

The simulation window displays a contour view. The contour view aids in the precise positioning of the tool or with contour tracking in the machining plane.

The contour view uses the following colors (defaults):

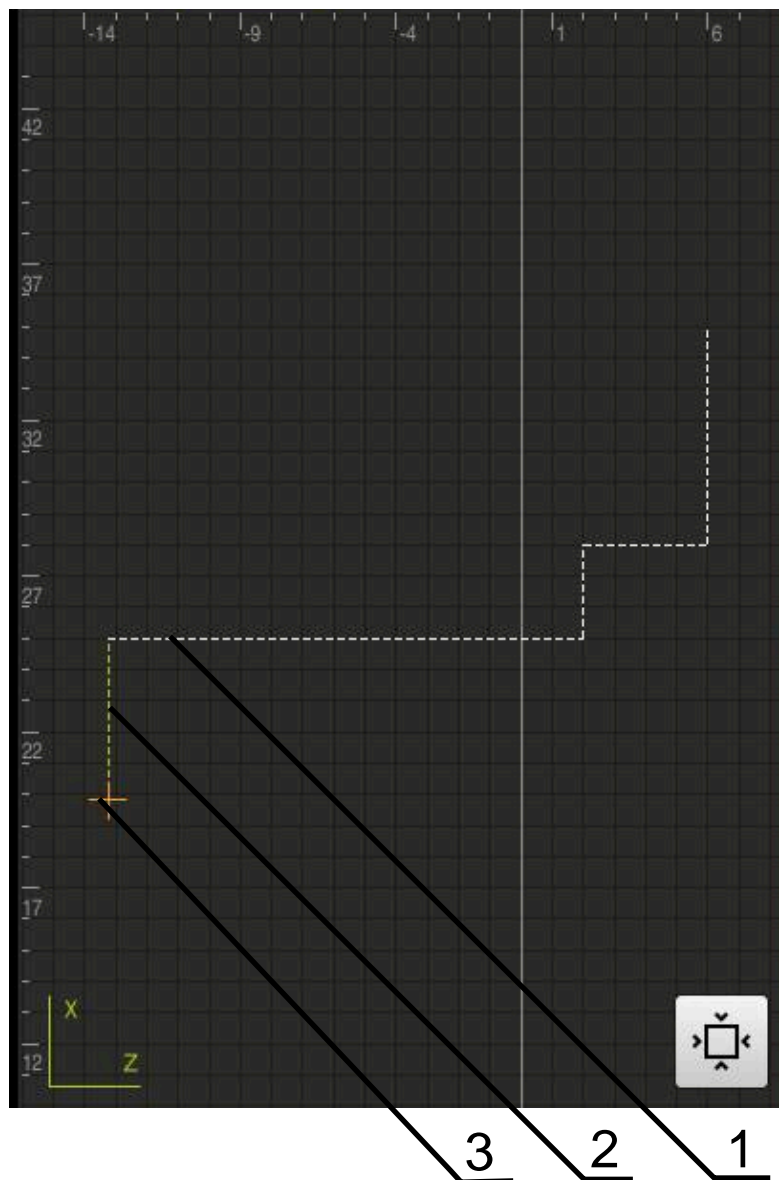

Figure 54: Simulation window with contour view

- 1 Machining pattern (white)
- 2 Current block or machining position (green)
- 3 Tool contour, tool position and tool track (orange)

4.4.2 Activating the simulation window



- ▶ Tap **Graphic-Form**
- ▶ The simulation window for the highlighted block appears.



- ▶ Tap **Graphic** on the view bar to enlarge the simulation window
- ▶ The parameter view is hidden and the simulation window is enlarged.

4.4.3 Checking a program in the simulation window



- ▶ Tap **Graphic**
- > The simulation window for the current program appears.
- ▶ Tap each program block, one after the other
- > The program steps are displayed in the simulation window; you can enlarge the detail view as needed.



- ▶ To enlarge the view, tap **Detail view**



- ▶ To return to the overview view, tap **Overview**

4.5 Managing programs

After you have created a program, you can save it for automatic program run or subsequent editing.

 The default storage location for programs is **Internal/Programs**.

4.5.1 Opening a program



- ▶ Tap **Open program** in the program management
- ▶ Select the storage location in the dialog, e. g. **Internal/Programs** or USB mass storage device
- ▶ Tap the folder containing the file
- ▶ Tap the file
- ▶ Tap **Open**
- > The selected program is loaded.

4.5.2 Closing a program



- ▶ Tap **Close program** in the program management
- > The opened program is closed.

4.5.3 Saving a program



- ▶ Tap **Save program** in the program management
- > The program is saved.

4.5.4 Saving a program under a new name



- ▶ Tap **Save program as** in the program management
- ▶ In the dialog, select the storage location, e. g. **Internal/Programs** or USB mass storage device, in which you want to save the program
- ▶ Enter a name for the program
- ▶ Confirm the entry with **RET**
- ▶ Tap **Save as**
- > The program is saved.
- > The name of the program is displayed on the toolbar.

4.5.5 Saving a program automatically



- ▶ Tap **Save program automatically** in the program management
- > All changes to the program will be automatically saved immediately.

4.5.6 Deleting a program



- ▶ Tap **Delete the program** in the program management
- ▶ Tap **Delete selection**
- ▶ Tap **OK** to confirm deletion
- > The program is deleted.

4.6 Editing program blocks

You can make later changes to any block of a program. To apply the changes to the program, you need to save the program again after you have made the changes.

Editing program blocks



- ▶ Tap **Open program** in the program management
- ▶ Select the storage location in the dialog, e.g. **Internal/Programs**
- ▶ Tap the folder containing the file
- ▶ Tap the file
- ▶ Tap **Open**
- > The selected program is loaded.
- ▶ Tap the desired block
- > The parameters of the selected block are displayed.
- ▶ Edit the relevant parameters, depending on the block type
- ▶ Confirm each entry with **RET**



- ▶ Tap **Save program** in the program management
- > The edited program is saved.

5

Application example

5.1 Overview

This chapter describes the production of an example workpiece. This chapter will guide you step by step through the unit's various machining options as you machine the example workpiece. For successful machining of the stud bolt you will need to perform the following machining steps:

Machining step	Mode of operation
Setting up the lathe	Manual operation
Roughing the outside contour	Manual operation
recess	Manual operation
Turning the chamfer	Manual operation
Finishing the outside contour	Manual operation
Thread cutting	MDI mode

Requirements:

- X axis as NC axis
- Z axis as NC axis
- Rotational axis as NC axis or spindle with orientation

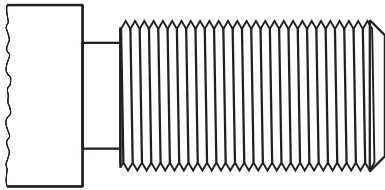

Figure 55: Example workpiece



Make sure that you have read and understood the "Basic Operation" chapter before carrying out the actions described below.

Further information: "Basic Operation", Page 19

5.2 Logging in for the application example

User login

For the application example, the **Operator** user must log in.



- ▶ Tap **User login** in the main menu
- ▶ If required, log out the user who is currently logged in
- ▶ Select the **Operator** user
- ▶ Tap the **Password** input field
- ▶ Enter the password "operator"



If a password other than the default password has been assigned to the user, ask a **Setup** or **OEM** user for the assigned password.
If the password is no longer known, contact a HEIDENHAIN service agency.

- ▶ Confirm entry with **RET**
- ▶ Tap **Log in**



5.3 Requirements

Use a manually operated lathe to machine the stud bolt. The following dimensioned technical drawing is available for the stud bolt:

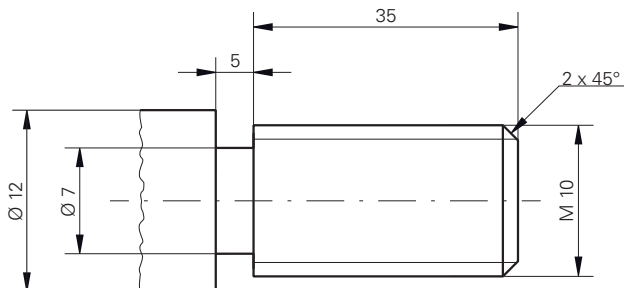

Figure 56: Example workpiece – technical drawing

Lathe

- The lathe is switched on
- A workpiece blank with \varnothing 12 mm is clamped into the lathe

Product

- The axes are referenced
Further information: "Conducting the reference mark search", Page 228

Tools

The following tools are available:

Tool	Image
Roughing tool	
Finishing tool	
Recessing tool 3 mm	
Turning chisel (45°)	
Thread turning insert P = 1.5 mm	

Tool table

For the example it is presumed that the tools for machining are not yet defined. You must add in advance all of the tools to be used to the tool table.

Further information: "Creating a tool table", Page 167



- ▶ Tap **Tools** on the status bar
- > The **Tools** dialog box appears.



- ▶ Tap **Open table**
- > The **Tool table** dialog box appears.



- ▶ Tap **Add**
- ▶ Enter the designation **Finishing tool** in the **Tool type** input field
- ▶ Confirm your input with **RET**
- ▶ Enter the value **0** in the **X** input field
- ▶ Confirm your input with **RET**
- ▶ Enter the value **0** in the **Z** input field
- ▶ Confirm your input with **RET**
- > The defined finishing tool is added to the tool table.



- ▶ Repeat this process for the other tools
- ▶ Tap **Close**
- > The **Tool table** dialog is closed.

5.4 Setting up the lathe

In the first machining step, you will set up the lathe. The unit requires the parameters of the individual tools for the calculation for the relative coordinate system. In order to manufacture a workpiece, you will need one of the presets you defined.

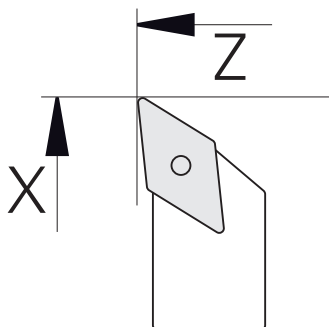

Figure 57: Finishing tool parameters

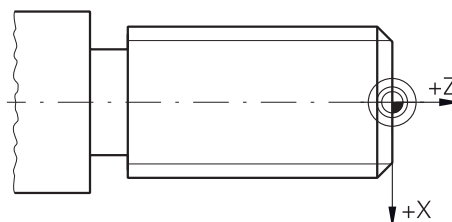

Figure 58: Preset

Call



- ▶ Tap **Manual operation** in the main menu
- > The user interface for Manual operation appears.

Coupling axes



For a lathe with a **Z** saddle and a **Zo** top slide, you have the option of coupling both the **Z** and **Zo** axes.



- ▶ In the working space, drag the **Z axis key** to the right



- ▶ Tap **Couple**
- > The **Zo** axis is coupled with the **Z** axis.



- > The icon for the coupled axes appears next to the **axis key Z**.
- > The position value for the coupled axes is shown as a sum.

5.4.1 Measuring the reference tool

For every tool used, determine the position of the cutting edges (for X and/or Z) in relation to the machine coordinate system or to the workpiece preset. To do so, first define a tool based on which all further parameters of the other tools are calculated. In this example, the finishing tool will be used as the reference tool.



- ▶ Insert the finishing tool into the tool holder
- ▶ Tap **Tools** on the status bar
- > The **Tools** dialog box appears.
- ▶ Tap **Finishing tool**



- ▶ Tap **Confirm**
- > The **finishing tool** is shown in the status bar.
- ▶ Set a spindle speed of 1500 rpm



- ▶ Tap **Auxiliary functions** in the status bar



- ▶ Tap **Tool data**
- > The **Set tool data** dialog box opens.
- ▶ Approach the workpiece blank with the finishing tool and perform a touch-off



- ▶ When the appropriate Z value is reached, tap **Save position**
- ▶ Perform face turning with the finishing tool
- ▶ Move the tool to a safe position
- ▶ In the **Z** input field, enter the value **0**



- ▶ Approach the workpiece blank with the finishing tool
- ▶ When the appropriate X value is reached, tap **Save position**
- ▶ Turn a step on the outside diameter of the workpiece blank using the finishing tool
- ▶ Move the tool to a safe position
- ▶ Spindle OFF



- ▶ Measure the turned outside diameter using an appropriate measuring tool

- ▶ Enter the measured value in the **X** input field

- ▶ Tap **Confirm** in the wizard
- > The **Select the tool** dialog box appears.

- ▶ Tap **Finishing tool**



- ▶ Tap **Confirm** in the wizard
- > The parameters are adopted in the tool table.

5.4.2 Tool measurement

You have already defined a finishing tool as the reference tool. For every additional tool, you must determine its offset from the reference tool. During measurement, the parameters of the measured tools are automatically offset from the parameters of the reference tool. The measured parameters are separate for each tool and are retained even after you have deleted the reference tool. In the example, the roughing tool is added as a tool.



- ▶ Insert the roughing tool into the tool holder
- ▶ Tap **Tools** on the status bar
- > The **Tools** dialog box appears.
- ▶ Tap **Roughing tool**



- ▶ Tap **Confirm**
- > The **roughing tool** is shown in the status bar.
- ▶ Set a spindle speed of 1500 rpm
- ▶ Tap **Auxiliary functions** in the status bar



- ▶ Tap **Tool data**
- > The **Set tool data** dialog box opens.
- ▶ Move the tool to the plane surface until tiny chips occur
- ▶ When the appropriate Z value is reached, tap **Save position**
- ▶ Move the tool to a safe position
- ▶ In the **Z** input field, enter the value **0**



- ▶ Approach the workpiece blank with the roughing tool
- ▶ When the appropriate X value is reached, tap **Save position**
- ▶ Turn a step on the outside diameter of the workpiece blank using the roughing tool
- ▶ Move the tool to a safe position
- ▶ Spindle OFF



- ▶ Measure the turned outside diameter using an appropriate means of measurement
- ▶ Enter the measured value in the **X** input field



- ▶ Tap **Confirm** in the wizard
- > The **Select the tool** dialog box appears.



- ▶ Tap **roughing tool**
- ▶ Tap **Confirm** in the wizard
- > The parameters are adopted in the tool table.
- ▶ Repeat this process for the other tools

5.4.3 Finding the preset

To machine the stud bolt, you will need to find the preset. According to the drawing, the dimensions are referenced to the start of the thread. Based on this preset the product then calculates all values for the relative coordinate system.

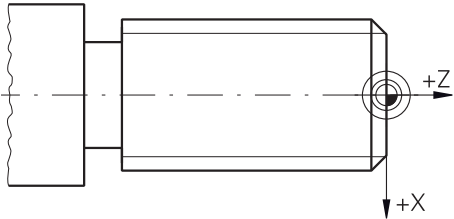

Figure 59: Example workpiece – finding the preset



- ▶ Insert the finishing tool into the tool holder
- ▶ Tap **Tools** on the status bar
- > The **Tools** dialog box appears.



- ▶ Tap **Finishing tool**
- ▶ Tap **Confirm**
- > The **finishing tool** is shown in the status bar.



- ▶ Tap **Auxiliary functions** in the status bar



- ▶ Tap **Presets** in the dialog
- > The **Set preset data** dialog box opens.
- ▶ Move the finish-turning tool in the negative direction for approx. 1 mm behind the plane surface machined before



- ▶ Tap **Save position**
- > The current position of the tool is saved.



- ▶ Move the tool to a safe position
- ▶ In the **Z** input field, enter the value **0**
- ▶ Tap **Confirm** in the wizard
- > The **Select preset** dialog box appears.
- ▶ Select preset **0** in the **Selected preset** input field



- ▶ Tap **Confirm** in the wizard
- > The probed coordinate is loaded as preset.

5.5 Roughing the outside contour

In the second machining step, you will rough the outside contour. Turn the entire contour with a finishing allowance.

Transverse roughing

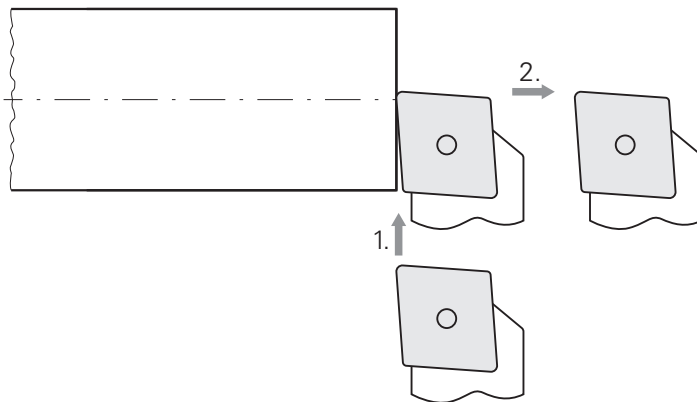

- ▶ Insert the roughing tool into the tool holder
- ▶ Tap **Tools** on the status bar
- > The **Tools** dialog box appears.
- ▶ Tap **Roughing tool**
- ▶ Tap **Confirm**
- > The associated tool parameters are applied automatically.
- > The **Tools** dialog is closed.
- ▶ Set a spindle speed of 1500 rpm
- ▶ Position the tool:
 - X: \emptyset 14.0 mm
 - Z: 0.2 mm
- ▶ Position the tool:
 - X: \emptyset -0.4 mm (1.)
- ▶ Move the tool to a safe position (2.)

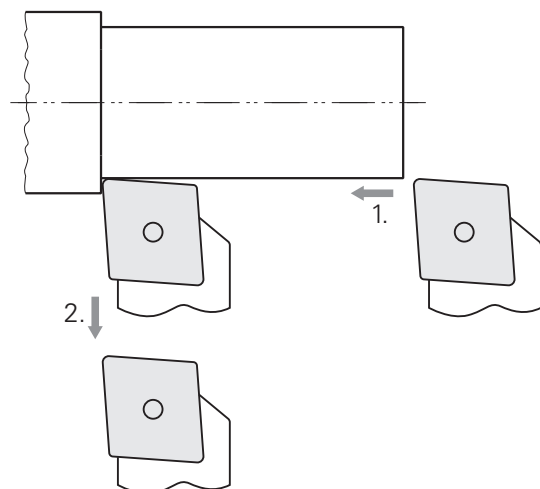
Longitudinal roughing

- ▶ Position the tool:
 - X: \varnothing 10.4 mm
 - Z: 2.0 mm
- ▶ Position the tool:
 - Z: -39.5 mm (1.)
- ▶ Position the tool:
 - X: \varnothing 14.0 mm (2.)
- ▶ Move the tool to a safe position
- ▶ Switch off the spindle
- ▶ You have successfully roughed the outside contour.

5.6 Turning the recess

In the third machining step, you will turn the recess that serves as undercut.

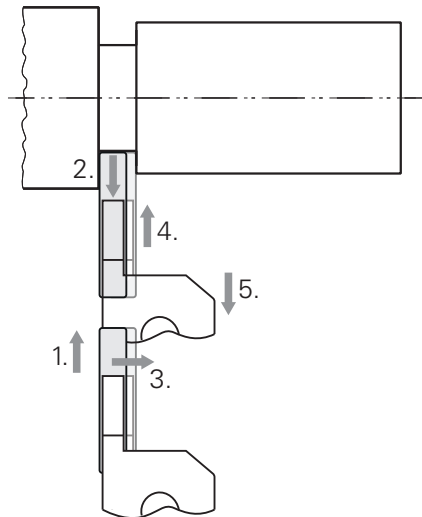

- ▶ Insert the recessing tool into the tool holder
- ▶ Tap **Tools** on the status bar
- > The **Tools** dialog box appears.
- ▶ Tap **Recessing tool 3 mm**
- ▶ Tap **Confirm**
- > The associated tool parameters are applied automatically.
- > The **Tools** dialog is closed.
- ▶ Set a spindle speed of 400 rpm
- ▶ Position the tool:
 - X: Ø 13.0 mm
 - Z: -40.0 mm
- ▶ Position the tool:
 - X: Ø 7.0 mm (1.)
- ▶ Position the tool:
 - X: Ø 13.0 mm (2.)
- ▶ Position the tool:
 - Z: -38.0 mm (3.)
- ▶ Position the tool:
 - X: Ø 7.0 mm (4.)
- ▶ Position the tool:
 - X: Ø 13.0 mm (5.)
- ▶ Move the tool to a safe position
- ▶ Switch off the spindle
- > You have successfully machined the recess.

5.7 Turning the chamfer

In the fourth machining step, you will turn the chamfer. The chamfer is necessary for the stud bolt to engage better when it is screwed in.

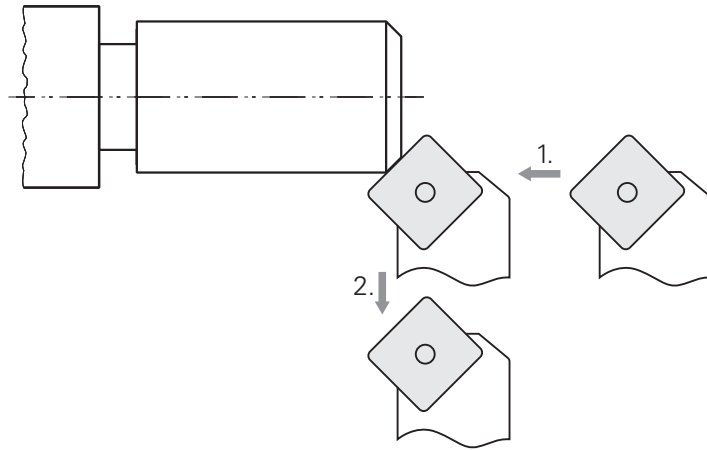

- ▶ Insert the turning chisel (45°) into the tool holder
- ▶ Tap **Tools** on the status bar
- > The **Tools** dialog box appears.
- ▶ Tap **Turning tool 45°**
- ▶ Tap **Confirm**
- > The associated tool parameters are applied automatically.
- > The **Tools** dialog is closed.
- ▶ Set a spindle speed of 1500 rpm
- ▶ Position the tool:
 - X: Ø 7.0 mm
 - Z: 2.0 mm
- ▶ Move the tool to the workpiece edge until tiny chips occur
- ▶ Note down the Z axis value
- ▶ Feed the tool by 2.2 mm in the Z axis (oversize of 0.2 mm + 2 mm from the chamfer) (1.)
- ▶ Move the tool to a safe position (2.)
- ▶ Switch off the spindle
- > You have successfully turned the chamfer.

5.8 Finishing the outside contour

In the fourth machining step, you will machine the outside contour using the finishing tool.

Transverse finishing

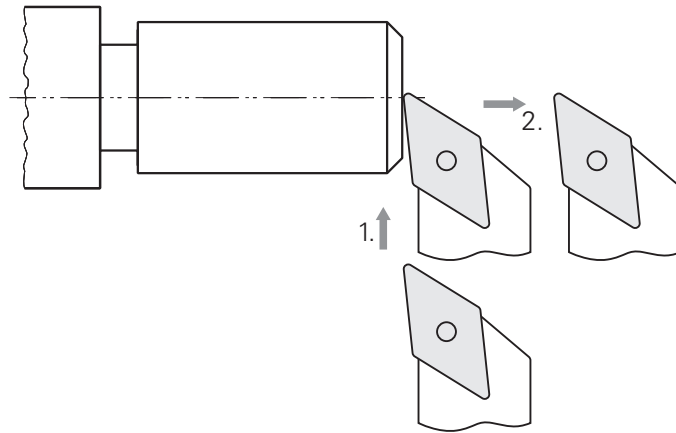

- ▶ Insert the finishing tool into the tool holder
- ▶ Tap **Tools** on the status bar
- > The **Tools** dialog box appears.
- ▶ Tap **Finishing tool**
- ▶ Tap **Confirm**
- > The associated tool parameters are applied automatically.
- > The **Tools** dialog is closed.
- ▶ Set a spindle speed of 2000 rpm
- ▶ Position the tool:
 - X: \varnothing 14.0 mm
 - Z: 0.0 mm
- ▶ Position the tool:
 - X: \varnothing -0.4 mm (1.)
- ▶ Move the tool to a safe position (2.)

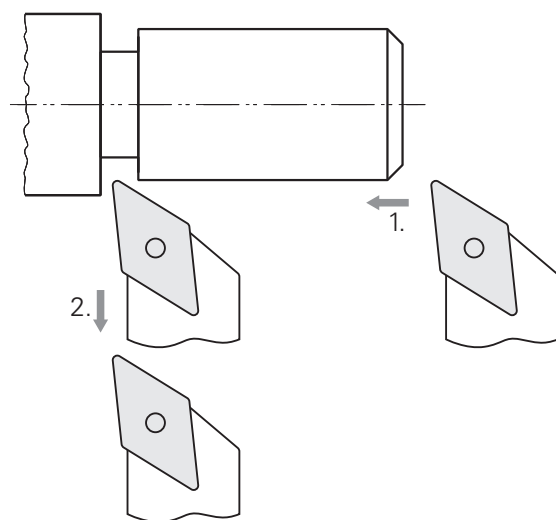
Longitudinal finishing

- ▶ Position the tool:
 - X: \varnothing 10.0 mm
 - Z: 2.0 mm
- ▶ Position the tool:
 - Z: -38.0 mm (1.)
- ▶ Move the tool to a safe position (2.)
- ▶ Switch off the spindle
- You have successfully finished the outside contour.

5.9 Machining threads

The thread is machined in MDI mode. You can find the input parameters for the thread in a book of metal tables, for example.

Requirements:

- X axis as NC axis
- Z axis as NC axis
- Rotational axis as NC axis or spindle with orientation

i If your lathe does not meet the requirements, you can machine the thread with a threading die, for example. Alternatively, you can use the wheels for the 1.5 mm pitch and turn the thread using the clasp nut.

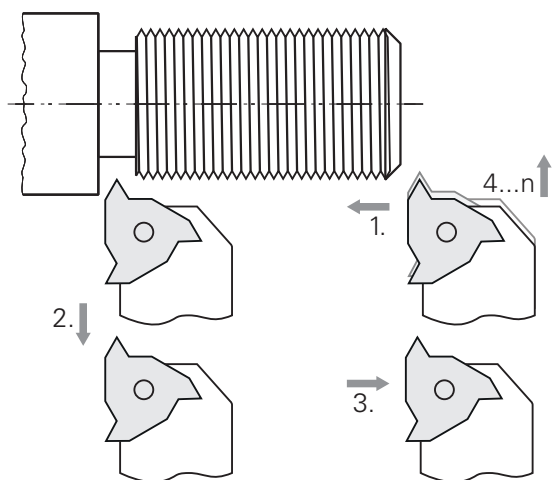

Figure 60: Example workpiece – machining the thread

Call



- ▶ Tap **MDI** in the main menu
- > The user interface for MDI mode is displayed.

5.9.1 Defining threads



- ▶ Tap **Tools** on the status bar
- > The **Tools** dialog box appears.
- ▶ Tap **Thread turning insert P = 1.5**



- ▶ Tap **Confirm**
- > The associated tool parameters are applied automatically.
- > The **Tools** dialog is closed.



- ▶ Tap **Create** on the status bar
- > A new block is displayed.
- ▶ In the **Block type** drop-down list, select the **Thread cutting (extended)** block type
- ▶ Enter the following parameters according to the book of metal tables:
 - **Thread position:** External thread
 - **Direction of rotation:** Clockwise
 - **Safety clearance:** 5
 - **Thread diameter:** 10
 - **Thread depth:** 0.92
 - **Cut depth:** 0.1
 - **Finishing allowance:** 0.0
 - **Thread pitch:** 1.5
 - **Contour start in Z:** 0
 - **Contour end in Z:** -37
 - **Overrun:** 3
 - **Starting angle:** 0
 - **Rotational speed:** 500
 - **Feed rate in X:** 50
 - **Air cuts:** 3



- ▶ Confirm each entry with **RET**
- ▶ To execute the block, tap **END**
- > The positioning aid is displayed.
- > If the simulation window is activated, the thread is visualized.

5.9.2 Thread cutting



- ▶ Insert the thread turning insert P = 1.5 mm in the tool holder
- ▶ Tap the **NC START key**



- ▶ Set a spindle speed of 500 rpm
- ▶ Follow the instructions in the wizard
- ▶ After the first cut, measure over 10 turns and check the distances (15 mm)
- ▶ Follow the instructions in the wizard
- ▶ Tap **Close**
- > Program run is ended.
- > The wizard closes.
- > Check the thread, for example with a counterpart or a thread ring gage.
- > You have successfully machined the thread.

6

What to do if ...

6.1 Overview

This chapter describes the causes of faults or malfunctions of the product and the appropriate corrective actions.



Make sure that you have read and understood the "Basic Operation" chapter before carrying out the actions described below.

Further information: "Basic Operation", Page 19

6.2 Exporting logging files

After a malfunction of the device, the logging files can be useful for HEIDENHAIN during troubleshooting. For this purpose, you have to export the logging files directly after restarting the device.

Exporting to a USB mass storage device

Prerequisite: The USB mass storage device must be connected.



- ▶ Tap **File management** in the main menu
- ▶ Tap **System** in the **Internal** memory location
- ▶ Drag the **Logging** folder to the right
- > The operating elements are displayed.



- ▶ Tap **Copy to**
- ▶ In the dialog, select the desired storage location of the connected USB mass storage device
- ▶ Tap **Select**
- > The folder is copied.



Send the folder to **service.ms-support@heidenhain.de**. Specify the model designation and the software version being used.

6.3 System or power failure

Operating system data can be corrupted in the following cases:

- System or power failure
- Switching off the product without shutting down the operating system

If the firmware is damaged, the product starts a Recovery System that displays short instructions on the screen.

With restoration, the Recovery System overwrites the damaged firmware with a new firmware previously saved to a USB mass storage device. During this procedure the settings of the product are deleted.

6.3.1 Restoring the firmware

- ▶ On a computer, create the folder "heidenhain" on a USB mass storage device (FAT32 format).
- ▶ In the "heidenhain" folder, create the folder "update"
- ▶ Copy the new firmware to the "update" folder
- ▶ Rename the firmware "recovery.dro"
- ▶ Switch off the product
- ▶ Connect a USB mass storage device to a USB port of the product
- ▶ Switch on the product for five seconds
- ▶ Switch off the product for five seconds
- ▶ Switch on the product
- > The product starts the Recovery System.
- > The USB mass storage device is detected automatically.
- > The firmware is installed automatically.
- > After a successful update, the firmware is automatically renamed "recovery.dro.[yyyy.mm.dd.hh.mm]".
- ▶ Restart the product on completion of the installation
- > The product starts up with the factory defaults.

6.3.2 Restoring settings

Reinstalling the firmware resets the product to the factory defaults. This deletes the settings, including the error compensation values and the activated software options.

To restore settings, you must either reconfigure them on the unit yourself or restore previously backed up settings on the unit.



Software options that were active when the settings were backed up must be activated before restoring the settings on the product.

- ▶ Activating software options
Further information: "Activating Software options", Page 86
- ▶ Restoring settings
Further information: "Restoring settings", Page 209

6.4 Malfunctions

If faults or malfunctions that are not listed in the "Troubleshooting" table below occur during operation, refer to the machine tool builder's documentation or contact a HEIDENHAIN service agency.

6.4.1 Troubleshooting

i The following troubleshooting steps must be performed only by the personnel indicated in the table.
Further information: "Personnel qualification", Page 16

Fault	Cause of fault	Correction of fault	Personnel
The status LED remains dark after switch-on	There is no supply voltage	▶ Check the power cable	Electrical specialist
	The product does not function properly	▶ Contact a HEIDENHAIN service agency	Qualified personnel
A blue screen appears when the unit starts up	Firmware error during startup	▶ If this fault occurs for the first time, switch the product off and then on again ▶ If the fault recurs, contact a HEIDENHAIN service agency	Qualified personnel
After startup, the product does not recognize any entries made on the touch-screen	Incorrect hardware initialization	▶ Switch the product off and then on again	Qualified personnel
Axes do not count despite movement of the encoder	Incorrect connection of the encoder	▶ Correct the connection ▶ Contact the encoder manufacturer's service agency	Qualified personnel
Axes are miscounting	Incorrect settings of the encoder	▶ Check the encoder settings Page 94	Qualified personnel
Axes cannot be moved	Incorrect axis settings	▶ Check the axis settings	Qualified personnel
	Feed-rate override is at zero	▶ Check position of the feed rate override potentiometer	Qualified personnel
Positioning error	Incorrect axis settings	▶ Check the axis settings	Qualified personnel
Standstill error	Incorrect axis settings	▶ Check the axis settings	Qualified personnel
Axes cannot be moved with the jog buttons	Incorrect axis settings	▶ Check the axis settings	Qualified personnel
	Incorrect operating mode (MDI mode, programming)	▶ Check the operating mode	Qualified personnel
	Feed rate override is at zero	▶ Check position of the feed rate override potentiometer	Qualified personnel
Feed rate override does not limit the axis speed	Incorrect feed rate override settings	▶ Check the axis settings	Qualified personnel
Rapid traverse key does not work	Incorrect rapid traverse settings	▶ Check settings Page 121	Qualified personnel
External axis error	External peripherals	▶ Conduct a systematic error search	Qualified personnel, possibly OEM

Fault	Cause of fault	Correction of fault	Personnel
Spindle error	Incorrect settings of the spindle axis	▶ Check the settings of the spindle axes Page 127	Qualified personnel, possibly OEM
	External peripherals	▶ Perform systematic error search	Qualified personnel, possibly OEM
Spindle stop	External peripherals	▶ Conduct a systematic error search	Qualified personnel, possibly OEM
Cycles cannot be started with Cycle Start	Incorrect setting of Automatic feed	▶ Check settings Page 121	Qualified personnel
Cycle start key lighting does not work	Incorrect setting of Autostart light	▶ Check settings Page 123	Qualified personnel
Reversal during thread cutting does not work	Incorrect setting of Spindle sleeve final position +/-	▶ Check settings	Qualified personnel
Automatic traversing to the limit switch does not work	Incorrect setting of Software limit switches or Automatic feed	▶ Check settings Page 120 Page 121	Qualified personnel
Outside of software limit switches	Incorrect setting of Software limit switches	▶ Check settings Page 120	Qualified personnel
Emergency stop	External peripherals	▶ Conduct a systematic error search	Qualified personnel, possibly OEM
Control voltage is missing	External peripherals	▶ Conduct a systematic error search	Qualified personnel, possibly OEM
Connection to the network is not possible	Defective connection	▶ Check the cable and the correct connection to X116	Qualified personnel
	Incorrect settings of the network	▶ Check the network settings Page 164	Qualified personnel
Network error: Host is down	Incorrect setting of the network drive options	▶ Add vers=2.1 in the connection options Page 165	Qualified personnel
The connected USB mass storage device is not detected	Defective USB connection	▶ Check the correct position of the USB mass storage device in the port ▶ Use another USB port	Qualified personnel
	The type or formatting of the USB mass storage device is not supported	▶ Use another USB mass storage device ▶ Format USB mass storage device with FAT32	Qualified personnel
The unit starts in recovery mode (text only mode)	Firmware error during startup	▶ If this fault occurs for the first time, switch the product off and then on again ▶ If the fault recurs, contact a HEIDENHAIN service agency	Qualified personnel

Fault	Cause of fault	Correction of fault	Personnel
User login is not possible	Password does not exist	<ul style="list-style-type: none">▶ As user with higher permission level, reset the password Page 161▶ To reset the OEM password, contact the HEIDENHAIN service agency	Qualified personnel

IV Index

- "
- "Start central drive" special function..... 110
- A**
- Accessories..... 62
- Activating Software options..... 86
- Adding a startup screen..... 142
- Ambient conditions..... 215
- Application
 - Selecting..... 86
- Applying the scaling factor 244, 253
- Assembly..... 66
- Audio feedback..... 53
- axes..... 94
- B**
- Block types..... 257
- C**
- Central drive..... 105
 - Movement detection..... 109
 - Program run..... 149
 - Start special function..... 110
- Cleaning..... 200
- Cleaning the screen..... 200
- Code number..... 26
- commissioning..... 84
- Computer..... 79
- Configuration
 - Axis + NC..... 111
- Configuring
 - Keyboard..... 166
 - network drive..... 165
 - Presets..... 169
 - Touchscreen..... 166
- Configuring network settings..... 164
- Configuring the central drive..... 104
- Configuring the OEM logo..... 143
- Configuring virtual axis keys..... 125
- Connecting encoders..... 75
- Connection
 - Computer..... 79
- Connection overview..... 73
- Contour view..... 243, 252, 264
 - detail view..... 253
 - overview..... 253
- Coordinate system
 - Defining presets..... 229
 - In Programs..... 257
- Coupled axis..... 136
- Coupling axes..... 272
- Cycles..... 238, 258
- D**
- Damage in transit..... 63
- Data backup..... 154, 172
- date and time..... 89, 160
- decimal places..... 89, 160
- Device
 - installing..... 72
- Diagnostics
 - 1 Vpp/11 μ App..... 203
 - EnDat..... 204
- Diameter axis..... 137
- Documentation
 - Addendum..... 11
 - Downloading..... 10
 - OEM..... 142
- Dragging..... 21
- Duo-Pos..... 68
- E**
- Electrical specialist..... 17
- Encoders
 - Axis parameter configuration (1 Vpp, 11 μ App)..... 94
 - Configuring axis parameters (EnDat)..... 93
- EnDat
 - Errors and warnings..... 206
 - Functional reserves..... 205
- energy saving mode..... 24
- Error compensation
 - linear error compensation..... 100
 - Methods..... 99
 - performing..... 99
 - segmented linear error compensation..... 101
 - Table of supporting points..... 102
- Error messages..... 51, 150
 - configuring..... 151
- Errors and warnings..... 206
- Example
 - Finishing the outside contour 279
 - preset..... 275
 - Roughing the outside contour..... 275
 - Setting up the lathe..... 272
 - Stud bolt drawing..... 269
 - Thread..... 282
 - Turning the chamfer..... 279
 - Turning the recess..... 278
 - Workpiece..... 268
- F**
- Feed-rate value
 - Setting..... 48
- File
 - copying..... 177
 - deleting..... 177
 - exporting..... 178
 - importing..... 179
 - moving..... 176
- opening..... 178
- renaming..... 177
- File management
 - file types..... 175
 - Menu..... 37
 - Short description..... 174
- Firmware update..... 201
- Folder
 - copying..... 176
 - creating..... 175
 - deleting..... 177
 - moving..... 176
 - renaming..... 176
- Folders
 - managing..... 175
- Folder structure..... 175
- Functional reserves..... 205
- G**
- Geared spindles..... 126
- Gear stages
 - configuring..... 134
- Gestures
 - Dragging..... 21
 - Holding..... 21
 - Operation..... 20
 - Tapping..... 20
- Ground connection, 3-wire cable. 80
- H**
- HEIDENHAIN encoders..... 92
- Holding..... 21
- I**
- Informational notes..... 13
- Input devices
 - connect..... 79
 - Operation..... 20
- Installation..... 72
- Installation Instructions..... 11
- Items supplied..... 61
- L**
- Language
 - setting..... 27, 83, 157
- Lathe
 - Tool measurement..... 273
- License key
 - Activating..... 87
 - Entering..... 88
 - requesting..... 86
- linear error compensation (LEC) 100
- Lissajous figure..... 203
- M**
- Machining block
 - Mirroring..... 47
 - Scaling..... 47
- Main menu..... 29

- Maintenance plan..... 201
 - Malfunctions..... 287
 - Managing programs..... 265
 - Manual operation..... 31
 - menu..... 31
 - MDI
 - menu..... 32
 - MDI mode
 - Applying the scaling factor.... 244, 253
 - Example..... 282
 - OverviewMenu
 - MDI mode..... 235
 - Menu
 - File management..... 37
 - manual operation..... 31, 226
 - MDI..... 32
 - Programming..... 35, 256
 - Program run..... 247
 - Settings..... 39
 - Switch-off..... 40
 - User login..... 38
 - Messages
 - closing..... 52
 - viewing..... 51
 - M functions
 - configuring..... 145, 149
 - manufacturer-specific..... 141
 - Overview..... 140
 - standard..... 141
 - mounting..... 66
 - Duo-Pos stand..... 68
 - Multi-Pos holder..... 70
 - Multi-Pos stand..... 69
 - Single-Pos stand..... 67
 - Mouse actions
 - Configuring..... 166
 - Dragging..... 21
 - Holding..... 21
 - Operation..... 20
 - Tapping..... 20
 - Movement detection..... 109
 - Moving with jog increment..... 233
 - Multi-Pos..... 69, 70
- O**
- Obligations of the operating company..... 17
 - OEM
 - adding documentation..... 142
 - adjusting display..... 148
 - defining keyboard design..... 148
 - modifying startup screen..... 142
 - OEM bar..... 49
 - Configuring..... 142
 - configuring M functions..... 145
 - displaying OEM logo..... 143
 - Functions..... 50
 - Operating elements..... 50
 - Operating elements
 - Add..... 23
 - Back..... 23
 - Close..... 23
 - Confirm..... 23
 - Drop-down list..... 23
 - Main menu..... 29
 - OEM bar..... 50
 - Plusminus button..... 22
 - Screen keyboard..... 22
 - Slide switch..... 23
 - status bar..... 45
 - Toggle switch..... 23
 - Undo..... 23
 - Operating Instructions..... 11
 - updating..... 163
 - Operation
 - Audio feedback..... 53
 - Energy saving mode..... 24
 - General operation..... 20
 - Gestures and mouse actions... 20
 - Messages..... 51
 - Operating elements..... 22
 - Touchscreen and input devices..... 20
 - Wizard..... 53
 - Operator..... 17
 - Override display..... 148
 - Overrides..... 123
 - Overview of new and modified functions..... 9
- P**
- Password..... 26
 - changing..... 84, 158, 162
 - creating..... 162
 - Default settings.. 26, 82, 156, 269
 - Personnel qualification..... 16
 - Pin layout
 - encoders..... 75
 - line voltage..... 80
 - network..... 80
 - switching inputs..... 76
 - Power connector..... 80
 - Preset
 - Defining..... 229
 - In programs..... 257
 - Probing..... 49
 - Preset table
 - Creating..... 169
 - Product
 - commissioning..... 84
 - Setting up..... 159
 - Switch-off..... 25
 - Switch-on..... 24
 - Product data..... 214
 - Program
 - aborting program run..... 251
 - adding blocks..... 262
 - Applying the scaling factor.... 244, 253
 - closing..... 254, 265
 - control blocks..... 251
 - creating..... 261
 - creating program header..... 262
 - deleting..... 266
 - deleting blocks..... 262
 - opening..... 254, 265
 - running (manual)..... 250
 - running (NC-controlled)..... 250
 - running (single block)..... 250
 - running blocks..... 266
 - saving..... 262, 265
 - Using..... 248
 - Program execution..... 148
 - Programming
 - Machine functions..... 258
 - Menu..... 35
 - Short description..... 256
 - Using the simulation window 263
 - Programming support..... 261
 - Program run..... 247
 - Menu..... 34
 - Short description..... 247
- Q**
- Qualified personnel..... 17
 - Quick start..... 268
- R**
- Reference mark search
 - activating..... 140
 - performing after startup.... 27, 83, 157, 228
 - Repackaging..... 64
 - rounding methods..... 89, 160
- S**
- Safety precautions..... 13, 16
 - general..... 17
 - Peripheral devices..... 17
 - ScreenshotClient
 - Information..... 152
 - Segmented linear error compensation (SLEC)..... 101
 - Settings
 - Backing up..... 153, 171
 - menu..... 39
 - quick access menu..... 46
 - Restoring..... 209
 - Setup..... 159
 - Simulation window..... 251
 - activating..... 253
 - Single-Pos..... 67
 - Spindle

- Configuring inputs and outputs..... 126
 - spindle axis..... 126
 - Spindle speed
 - programming..... 50
 - setting..... 50
 - Upper limit..... 227, 237
 - Starting the central drive..... 110
 - Status bar..... 45
 - adjusting the quick access menu..... 46
 - Calculator..... 48
 - Feed rate..... 48
 - Jog increment..... 49
 - operating elements..... 45
 - Stop watch..... 48
 - Storage..... 64
 - Switch-off
 - Menu..... 40
 - Symbols and fonts used for marking text..... 14
 - Symbols on the product..... 18
- T**
- Table of supporting points
 - adjusting..... 103
 - creating..... 100, 101
 - Tapping..... 20
 - Text database
 - Creating..... 150
 - Thread cutting..... 138
 - Advanced..... 240, 260
 - Simple..... 239, 259
 - Tool
 - Calibrating..... 232
 - Creating..... 231
 - Selecting..... 232
 - Tool table
 - Creating..... 271
 - Touchscreen
 - Configuring..... 166
 - Operation..... 20
 - Turning the chamfer..... 279
 - Turning the recess..... 278
- U**
- Units
 - Setting..... 46
 - units of measure..... 89, 160
 - Uploading license file..... 88
 - User
 - Configuring..... 162
 - creating..... 162
 - Default password..... 26
 - Deleting..... 162
 - Login..... 26
 - Logout..... 26
 - User login..... 25
 - user types..... 161
 - User files
 - Restoring..... 208
 - Saving..... 154, 172
 - User ID..... 162
 - User interface
 - After start-up..... 28
 - Factory default setting..... 28
 - File management menu..... 37
 - Main menu..... 29
 - manual operation menu..... 31
 - MDI menu..... 32
 - Programming menu..... 35
 - Program run menu..... 34
 - Settings menu..... 39
 - Switch-off menu..... 40
 - User login menu..... 38
 - User login..... 25, 38
- V**
- Virtual jog buttons..... 125
- W**
- Wiring switching inputs and outputs..... 76
 - Wizard..... 53

V List of figures

Image 1:	Screen keyboard.....	22
Image 2:	The user interface in the product's factory default setting.....	28
Image 3:	Manual operation menu.....	31
Image 4:	MDI menu.....	32
Image 5:	Program run menu.....	34
Image 6:	Programming menu.....	35
Image 7:	Programming menu with opened simulation window.....	36
Image 8:	File management menu.....	37
Image 9:	User login menu.....	38
Image 10:	Settings menu.....	39
Image 11:	Support from the wizard for action steps.....	53
Image 12:	Dimensions of the rear panel.....	66
Image 13:	Product mounted on Single-Pos stand.....	67
Image 14:	Cable routing on Single-Pos stand.....	67
Image 15:	Product mounted on Duo-Pos stand.....	68
Image 16:	Cable routing on Duo-Pos stand.....	68
Image 17:	Product mounted on Multi-Pos stand.....	69
Image 18:	Cable routing on Multi-Pos stand.....	69
Image 19:	Product mounted on Multi-Pos holder.....	70
Image 20:	Cable routing on Multi-Pos holder.....	70
Image 21:	Rear panel of devices with ID 1089176-xx	74
Image 22:	Rear panel of devices with ID 1089177-xx	74
Image 23:	Assignment of the rectangular coordinate system to the workpiece.....	91
Image 24:	Example – XML file for text database.....	150
Image 25:	The ScreenshotClient user interface.....	152
Image 26:	File management menu.....	174
Image 27:	File management menu with preview image and file information.....	178
Image 28:	Example of functional reserves of a length gauge.....	205
Image 29:	Dimensions of housing.....	216
Image 30:	Dimensions of rear panel of the product.....	216
Image 31:	Dimensions of the rear panel for devices with ID 1089176-xx.....	217
Image 32:	Dimensions of the rear panel for devices with ID 1089177-xx.....	217
Image 33:	Product dimensions with Single-Pos stand.....	218
Image 34:	Product dimensions with Duo-Pos stand.....	218
Image 35:	Product dimensions with Multi-Pos stand.....	219
Image 36:	Product dimensions with Multi-Pos holder.....	219
Image 37:	Manual operation menu.....	226
Image 38:	Upper limit for spindle speed dialog box.....	227
Image 39:	MDI menu.....	236
Image 40:	Upper limit for spindle speed dialog box.....	237
Image 41:	Schematic depiction of the Thread cutting (basic) block	239
Image 42:	Schematic depiction of the Thread cutting (extended) block.....	240
Image 43:	Example of a block in MDI mode.....	242
Image 44:	Simulation window with contour view.....	243
Image 45:	Distance to go with position view with graphical positioning aid.....	244

Image 46:	Example – MDI block.....	245
Image 47:	Example – Execution of an MDI block with scaling factor.....	245
Image 48:	Example of a program in the Program run operating mode.....	249
Image 49:	Simulation window with contour view.....	252
Image 50:	Programming menu.....	256
Image 51:	Schematic depiction of the Thread cutting (basic) block	259
Image 52:	Schematic depiction of the Thread cutting (extended) block.....	260
Image 53:	Example of a program in the Programming operating mode.....	261
Image 54:	Simulation window with contour view.....	264
Image 55:	Example workpiece.....	268
Image 56:	Example workpiece – technical drawing.....	269
Image 57:	Finishing tool parameters.....	272
Image 58:	Preset.....	272
Image 59:	Example workpiece – finding the preset.....	275
Image 60:	Example workpiece – machining the thread.....	282

HEIDENHAIN

DR. JOHANNES HEIDENHAIN GmbH

Dr.-Johannes-Heidenhain-Straße 5

83301 Traunreut, Germany

☎ +49 8669 31-0

☎ +49 8669 32-5061

info@heidenhain.de

Technical support ☎ +49 8669 32-1000

Measuring systems ☎ +49 8669 31-3104

service.ms-support@heidenhain.de

NC support ☎ +49 8669 31-3101

service.nc-support@heidenhain.de

NC programming ☎ +49 8669 31-3103

service.nc-pgm@heidenhain.de

PLC programming ☎ +49 8669 31-3102

service.plc@heidenhain.de

APP programming ☎ +49 8669 31-3106

service.app@heidenhain.de

www.heidenhain.com

