

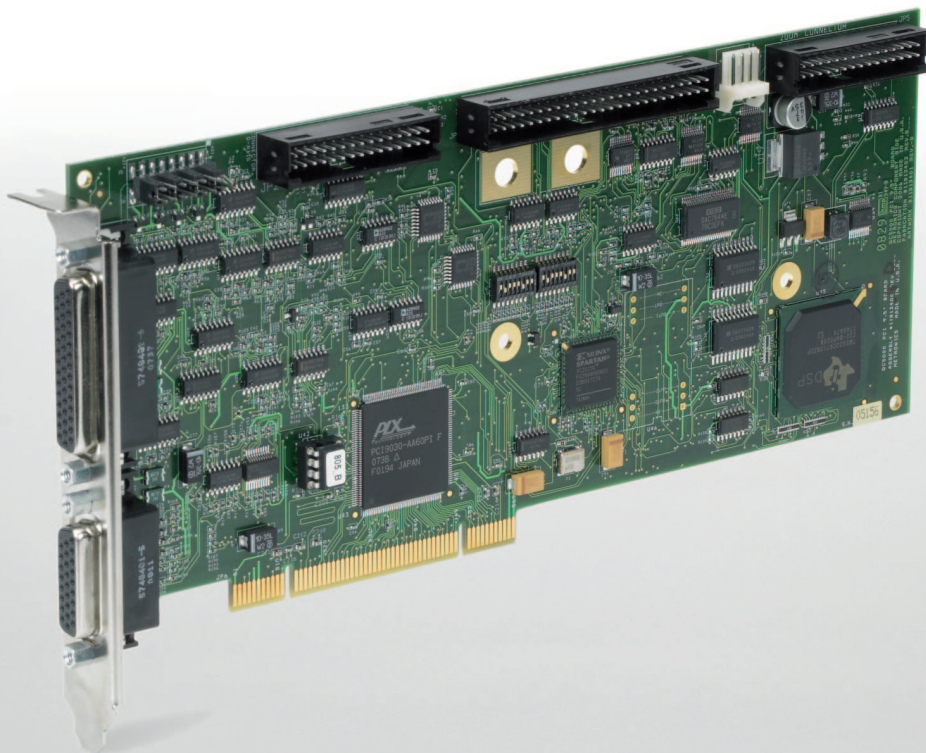

# HEIDENHAIN



Operating Instructions

## IK 5000 QUADRA-CHEK

(QC 5000)

Manual 3D Systems

English (en)  
2/2010



**Quadra-Chek® 5000**

**User's Guide**

## Proprietary notice

All information set forth in this document, all rights to such information, any and all inventions disclosed herein and any patents that might be granted by employing the materials, methods, techniques or apparatus described herein are the exclusive property of Metronics Incorporated, Bedford, New Hampshire.

No part of this document may be reproduced, stored in a retrieval system, or transmitted in any form or by any means, electronic, mechanical, photocopying, recording, or otherwise, without the prior permission of Metronics Incorporated. The information contained herein is designed only for use with the Quadra-Chek 5000 Metrology Software. Metronics Incorporated is not responsible for any use of this information as applied to any other apparatus.

## Disclaimer

The information contained in this document is subject to change without notice. Metronics Incorporated assumes no responsibility or liability for any errors or inaccuracies contained herein, or for incidental or consequential damage in connection with the furnishing, performance, or use of this guide.

Metronics Inc. shall not be liable to the purchaser of this product or third parties for damages, losses, costs, or expenses incurred by the purchaser or third parties as a result of: accident, misuse, or abuse of this product or unauthorized modifications, repairs, or alterations to this product, or failure to strictly comply with Metronics Incorporated's operating and maintenance instructions.

## Trademarks

Metronics, Quadra-Chek, Quadra-Chek 5000, and QC5000 are registered trademarks of Metronics Incorporated.

Other product names used herein are for identification purposes only and may be trademarks of their respective owners. Metronics Incorporated disclaims any and all rights to those marks.

## Printing History

April 2001 Revision 1.0	First Printing
Part Number:	11A10516
Software Version 2.2	
Printed in the USA.	





# QC5000 User's Guide

## Contents

---

- Chapter 1: Overview ..... 1**
- Welcome to the QC5000 ..... 1**
- About This Guide ..... 3**
  - Chapter 1: Overview ..... 3
  - Chapter 2: Using Probes ..... 3
  - Chapter 3: General Measuring ..... 3
  - Chapter 4: Advanced Measuring & Output ..... 3
  - Chapter 5: Programming ..... 3
  - Chapter 6: System Setup & Configuration ..... 3
  - Index ..... 3
- Icons and Type Faces ..... 4**
  - Warning ..... 4
  - Caution ..... 4
  - Note ..... 4
  - Italics ..... 4
- Starting The QC5000 ..... 5**
  - To open the QC5000 ..... 5
- Windows and Toolbars ..... 6**
- QC5000 Windows ..... 8**
  - DRO ..... 8
- The Results Window ..... 8**
  - Feature Specifications ..... 8
  - To move information from the results window to the features list ..... 9
  - Locked/unlocked features ..... 10
  - To unlock a feature ..... 10
  - To lock a feature ..... 10
  - Feature type diagram /feature stamp ..... 11
  - To open the feature stamp window ..... 11
- The Part View Window ..... 12**
  - Single pane part view ..... 12
  - Four pane part view ..... 12
- View Rotator ..... 13**
  - To use the view rotator ..... 13
- Template Windows ..... 14**
  - To separate template windows ..... 14
  - To nest template windows ..... 16
- Status Bar ..... 17**
  - To add items to the status bar ..... 18
  - To delete items from the status bar ..... 19
- Main Menu Bar ..... 22**
  - File ..... 22
  - Edit ..... 22
  - View ..... 23
  - Measure ..... 24
  - Datum ..... 24
  - Probe ..... 25

## Contents

Tools .....	26
Windows .....	26
Help .....	26
<b>Toolbars .....</b>	<b>27</b>
Datum toolbar .....	27
Measure toolbar .....	27
Probe toolbar .....	27
View toolbar .....	27
Tolerance toolbar .....	27
Program toolbar .....	27
File toolbar .....	28
To place a toolbar on the QC5000 desktop .....	28
To remove a toolbar from the QC5000 desktop .....	29
To add buttons to a toolbar .....	30
To remove buttons to a toolbar .....	32
<b>Chapter 2: Quick Start.....</b>	<b>33</b>
<b>Quick Start .....</b>	<b>33</b>
Set machine zero .....	33
Create a reference frame .....	34
Measure a line (minimum 2 points) .....	37
Measure a circle (minimum 3 points) .....	37
Measure a cone (minimum 6 points) .....	38
Measure a cylinder (minimum 6 points) .....	39
Measure a distance .....	40
Save a part file .....	41
<b>Chapter 3: Using Probes .....</b>	<b>43</b>
<b>Probing Technique.....</b>	<b>43</b>
Good probing techniques .....	43
Bad probing techniques .....	43
<b>Probe Toolbar .....</b>	<b>43</b>
Probe teach.....	43
Probe compensation off.....	43
Cardinal probe compensation .....	44
Polar probe compensation .....	44
Auto enter .....	44
Probe library .....	44
<b>Probe compensation .....</b>	<b>45</b>
Probe compensation off.....	45
Cardinal probe compensation .....	45
Polar probe compensation .....	45
To activate probe compensation .....	46
<b>Auto Enter .....</b>	<b>47</b>
To activate auto enter .....	47
<b>Probe Library .....</b>	<b>47</b>
<b>Probe Families &amp; Groups.....</b>	<b>48</b>
HardProbe group .....	48
TouchProbe group .....	49
StarProbe group .....	49
To create a new probe group .....	50
<b>Probe Calibration .....</b>	<b>52</b>
Master probe tips .....	52
To teach (qualify) a master probe tip .....	53
To teach (qualify) a non-master probe tip .....	54



<b>Changing Probes .....</b>	<b>55</b>
To view the probes in a group .....	55
To change the current probe tip .....	55
To add probe tips .....	57
To delete probe tips .....	59
<b>Probe Results Window .....</b>	<b>60</b>
<b>Chapter 4: General Measuring.....</b>	<b>63</b>
<b>Getting Started .....</b>	<b>63</b>
Set machine zero .....	63
To set machine zero .....	63
Reference Frame .....	66
Projection planes .....	67
Machine coordinates .....	68
Part coordinates .....	68
To create a reference frame .....	69
<b>Measuring 2D Features .....</b>	<b>72</b>
To probe a point .....	72
To probe a line (2 points) .....	73
To probe an arc (3 points) .....	74
To probe a circle (3 points) .....	75
To probe a slot (5 points) .....	76
To probe a plane (3 points) .....	77
<b>Measuring 3D Features .....</b>	<b>78</b>
To probe a cone (3 points) .....	78
To probe a cylinder (6 points) .....	79
To probe a sphere (5 points) .....	80
<b>Constructing Features .....</b>	<b>81</b>
<b>Point Constructions .....</b>	<b>81</b>
To construct a center point .....	81
To construct an apex point .....	82
To construct an application point .....	83
To construct an anchor point .....	84
To construct bounding points .....	85
To construct a point from 2 intersecting lines .....	86
To construct a closest point of approach point .....	87
To construct points from intersecting circles .....	88
To construct a midpoint from two circles .....	89
To construct a point from the intersection of a line and a circle .....	90
To construct a midpoint from 2 positional features .....	91
To construct a perpendicular point from a positional feature and a plane .....	92
To construct a point from a linear feature and a plane .....	93
To construct a point from the intersection of 3 planes .....	94
<b>Line Constructions .....</b>	<b>95</b>
To construct an axis line from a linear feature .....	95
To construct a plane axis line (Normal Line) .....	96
To construct a midline from the sides of a slot .....	97
To construct a 2 point line from two positional features .....	98
To construct a tangent line from 2 radial positional features .....	99
To construct a line from the intersection of 2 planes .....	101
To construct a bisector of 2 linear features .....	102
To construct a perpendicular bisector of 2 linear features .....	103
To construct a closest point of approach line from 2 linear features .....	105
To construct a line from a positional feature perpendicular to a linear feature .....	107
To construct a line parallel to a linear feature using a positional feature .....	108

## Contents

---

To construct a perpendicular line through a plane and a positional feature .....	110
To construct a rotated line from the leg of an angle and the angle .....	111
To construct a gage line .....	112
To construct a line by projecting an existing line on a new projection plane .....	114
<b>Circle Constructions .....</b>	<b>115</b>
To construct a circle from a sphere .....	115
To construct a circle from a cone .....	116
To construct a circle from an intersecting plane and cylinder .....	117
To construct a circle from an intersecting cylinder and cone .....	118
To construct a circle tangent to 2 intersecting lines .....	119
To change the location of a tangent circle .....	120
<b>Plane Constructions .....</b>	<b>121</b>
To construct a plane from the midpoint of a line .....	121
To construct a plane from a line and a positional feature .....	122
To construct a midplane from 2 planes .....	123
To construct a perpendicular midplane from 2 planes .....	124
<b>Sphere Constructions .....</b>	<b>125</b>
To construct a sphere from a cone .....	125
<b>Cylinder Constructions .....</b>	<b>126</b>
To construct a cylinder from to 2 co-axial circles .....	126
<b>Cone Constructions .....</b>	<b>127</b>
To construct a cone from 2 co-axial circles .....	127
<b>Measuring Relations .....</b>	<b>128</b>
Distance .....	128
Angle .....	128
<b>Distance Constructions .....</b>	<b>129</b>
To construct the length of an axis .....	129
To construct a duplicate distance .....	130
To construct a reverse direction distance .....	131
To construct an absolute distance .....	132
To construct a center to center distance .....	133
To construct a farthest edge distance .....	134
To construct a nearest edge distance .....	135
To construct a distance from a positional feature perpendicular to a linear feature .....	136
To construct the nearest to line distance .....	137
To construct the farthest to line distance .....	138
To construct a distance from a positional feature to a plane .....	139
To construct a center to plane distance from a sphere .....	140
To construct the nearest plane distance from a sphere .....	141
To construct the farthest plane distance from a sphere .....	142
To construct a bounded line distance from 2 lines .....	143
To construct a nearest bounded line distance from 2 lines .....	144
To construct a farthest bounded line distance from 2 lines .....	146
To construct an unbounded distance from 2 linear features .....	148
To construct a distance between 2 co-axial planes .....	150
<b>Angle Constructions .....</b>	<b>151</b>
To construct an angle from 2 linear features .....	151
<b>Saving Your Work .....</b>	<b>152</b>
To save a part file .....	152
To export to a CAD file .....	154
To export to SPC software .....	156
To export to Microsoft Access .....	158

<b>Chapter 5: Advanced Measuring &amp; Output.....</b>	<b>161</b>
<b>Datum Magic .....</b>	<b>161</b>
To create a datum using datum magic .....	161
<b>Measure Magic .....</b>	<b>163</b>
To measure a point using measure magic .....	163
To measure a line using measure magic (2 points) .....	164
To measure an arc using measure magic (3 points) .....	164
To measure a circle using measure magic (3 points) .....	165
To measure a plane using measure magic (3 points) .....	165
To measure a cone using measure magic (6 points) .....	166
To measure a cylinder using measure magic (6 points) .....	167
To measure a sphere using measure magic (4 points) .....	168
<b>Layers .....</b>	<b>169</b>
To create a new layer .....	169
Current Layer .....	170
To set a layer as current .....	170
To assign features to new layers .....	172
<b>Displaying Layers .....</b>	<b>174</b>
To hide a layer .....	174
To show a hidden layer .....	175
To turn off a layer .....	177
To turn on a layer .....	179
To assign a color to a layer .....	181
<b>Alternate Datums .....</b>	<b>184</b>
To rotate the reference frame (datum) .....	184
<b>Offset Alignments .....</b>	<b>186</b>
To perform an offset alignment (primary plane) .....	186
To perform an offset alignment (secondary line) .....	189
To perform an offset alignment (zero point) .....	192
<b>Tolerancing .....</b>	<b>194</b>
Tolerance Toolbar .....	194
To view the tolerance toolbar .....	194
Bi-directional tolerance (circles, points, arcs, spheres) .....	196
To perform a bi-directional tolerance .....	196
Pass/ Fail Displays .....	199
True position tolerance (circles, points arcs, spheres) .....	199
To perform a true position tolerance .....	199
MMC/LMC tolerance (circles, points arcs, spheres) .....	202
To perform a MMC tolerance .....	202
To perform a LMC .....	205
Concentricity tolerance (circles, arcs) .....	208
To perform a concentricity tolerance .....	208
Straightness tolerance (lines) .....	211
To perform a straightness tolerance (lines) .....	211
Circularity/sphericity tolerance (circles, spheres) .....	213
To perform a circularity tolerance .....	213
To perform a sphericity tolerance .....	215
Cylindricity tolerance (cylinders) .....	217
To perform a cylindricity tolerance .....	217
Flatness tolerance (planes) .....	219
To perform a flatness tolerance .....	219
Perpendicularity tolerance (lines, cylinders, cones) .....	221
To perform a perpendicularity tolerance .....	221
Parallelism/Co-planarity tolerance (linear features) .....	223

## Contents

To perform a parallelism tolerance .....	223
To perform a co-planarity tolerance .....	225
Circular runout tolerance .....	227
To perform a circular runout tolerance .....	227
Angle tolerance .....	229
To perform an angle tolerance .....	229
Width tolerance .....	231
To perform a width tolerance .....	231
<b>Chapter 6: Templates .....</b>	<b>233</b>
<b>Templates .....</b>	<b>233</b>
<b>Features Template .....</b>	<b>235</b>
To open the features template .....	235
<b>Adding Data to .....</b>	<b>237</b>
<b>Templates .....</b>	<b>237</b>
To drag and drop a single results window field into the features list .....	237
To drag and drop a multiple results window fields into the features list .....	238
Sorting the Features List .....	239
To sort data in the features list .....	239
<b>Reports Template .....</b>	<b>240</b>
To open the reports template .....	240
Adding Data to the Reports Template .....	242
To drag and drop a single results window field into the reports template .....	242
To drag and drop a multiple results window fields into the reports template .....	243
Sorting Data in the Reports Template .....	244
To sort data in the reports template .....	244
<b>Report Headers .....</b>	<b>245</b>
To show a report header .....	245
Customizing Report Headers .....	247
To place a graphic in a report header .....	247
To arrange text and graphics in a report header .....	248
<b>Automated Text Input &amp; Prompting .....</b>	<b>249</b>
<b>Overlays .....</b>	<b>250</b>
To save a report header as an overlay .....	250
To place an overlay in a report header .....	251
Program Template .....	252
To open the program template .....	252
Template Properties .....	254
To access the template features dialog box .....	254
Template Features Dialog Box .....	255
Display tab .....	255
<b>Filters tab .....</b>	<b>260</b>
To create a filter .....	261
To modify a filter .....	267
To remove a filter .....	269
Misc tab (miscellaneous) .....	270
<b>Column Properties .....</b>	<b>271</b>
Standard column properties .....	271
Appearance tab .....	271
Formulas tab .....	271
Parantheses( ) .....	271
Brackets [ ] .....	272
Quote marks "" .....	272
Min/Max .....	273
<b>Sample Formula .....</b>	<b>274</b>

To create the sample formula .....	274
To modify a formula .....	279
To remove a formula .....	281
<b>Runs Template .....</b>	<b>282</b>
To open the runs template .....	282
To add data to the runs template .....	283
<b>Nesting Template .....</b>	<b>284</b>
<b>Windows .....</b>	<b>284</b>
To nest template windows .....	284
To separate template windows .....	284
<b>Creating New Templates .....</b>	<b>286</b>
To create a new template .....	286
<b>Export .....</b>	<b>288</b>
To export a tab delimited file to a spreadsheet .....	288
To export a CSV (comma separated value) file to a spreadsheet .....	290
<b>Chapter 7: Programming .....</b>	<b>293</b>
<b>Programming Overview .....</b>	<b>293</b>
<b>The Program Toolbar .....</b>	<b>294</b>
Record/Edit Program .....	294
Pause Program .....	294
New Run .....	294
Run Program From Current Step .....	294
Run Just Current Step .....	294
<b>Recording a Program .....</b>	<b>295</b>
To create a program .....	295
To open a saved program .....	297
<b>Running A Program .....</b>	<b>298</b>
To run a program .....	298
<b>Sample Program .....</b>	<b>299</b>
To record the sample program .....	299
<b>Creating User Messages .....</b>	<b>308</b>
To Insert A User Message .....	308
<b>Expanding the Program Toolbar .....</b>	<b>309</b>
Toggle Break Point .....	309
Program Comment .....	309
Edit Steps .....	309
If-Goto .....	309
If-Then .....	309
Else .....	310
Else-If .....	310
Super Step .....	310
Goto Label .....	310
Offset Positions .....	310
Toggle Break Point .....	310
Program Comment .....	311
Edit Steps .....	311
If-Goto .....	311
If-Then .....	311
Else .....	311
Else-If .....	311
Super Step .....	312
Goto Label .....	312
Offset Positions .....	312

## Contents

To add buttons to a toolbar .....	313
To delete buttons from a toolbar .....	315
<b>Conditional Statements .....</b>	<b>317</b>
Test Conditions .....	317
Actions .....	317
Arithmetic Operators .....	318
If-Goto Statement .....	319
If-Then Statement .....	320
Else Statement .....	321
Else-If Statement .....	322
Parantheses( ) .....	323
Brackets [ ] .....	323
Quote marks "" .....	324
Min/Max .....	324
<b>Chapter 8: System Setup &amp; Configuration .....</b>	<b>327</b>
<b>Before You Begin .....</b>	<b>327</b>
<b>Hardware Setup .....</b>	<b>327</b>
<b>Encoder Setup .....</b>	<b>328</b>
To setup encoders .....	328
<b>Troubleshooting .....</b>	<b>332</b>
<b>Encoder Setup .....</b>	<b>332</b>
Encoder setup shows continual errors, beeps, or inconsistent wave output .....	332
Encoder setup show one or two errors after calibrating an axis .....	333
Encoder setup shows numerous errors after calibrating an axis .....	334
Wave (amplitude) calibrates, phase does not calibrate .....	337
TTL encoders will not calibrate .....	338
Status bar freezes during calibration or other error message .....	340
Encoder setup icon is missing .....	342
QC5000 counts double, half, or wrong .....	344
<b>Supervisor Password .....</b>	<b>348</b>
To enter the supervisor password .....	348
To restrict access to general options tabs .....	350
<b>General Options .....</b>	<b>352</b>
Buttons .....	352
To set a button function .....	354
Display .....	355
Encoders .....	358
To enter encoder resolution .....	360
General .....	361
To set machine zero .....	361
Measure .....	363
Part view .....	368
Probes .....	370
To enter the diameter of a qualification sphere .....	371
Point Filtration .....	374
Files .....	376
SLEC (segmented linear error correction) .....	377
To enter SLEC data .....	378
Sounds .....	385
Square .....	387
To test for squareness .....	387
To square axes .....	388
<b>Index .....</b>	<b>389</b>

# Chapter 1

## Overview

---

### Welcome to the QC5000

The Quadra-Chek 5000 software suite is an advanced software application for coordinate measurement machines (CMM). It features a graphical user interface for simple point and click operation. Point the cursor to a feature on the measure toolbar and click.

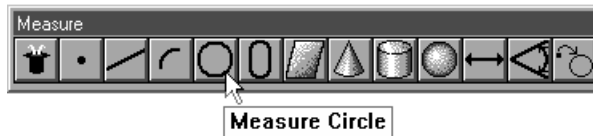

The QC5000 measures part features using the simplest geometric components: points. Lines can be created from two points, circles from three points, and cones from six points. Simply probe the points and the QC5000 measures the feature.

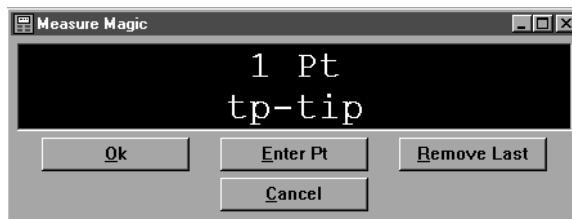

Once the required number of points are entered the QC5000 displays the feature in the part view window.

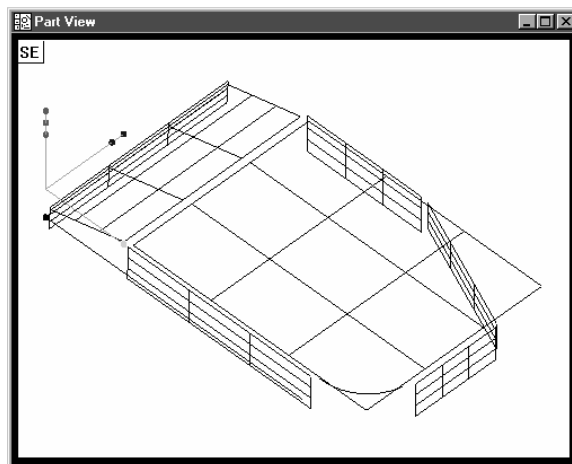

## Chapter 1 Overview

---

The QC5000 continues building the part in the part view window as features are added.

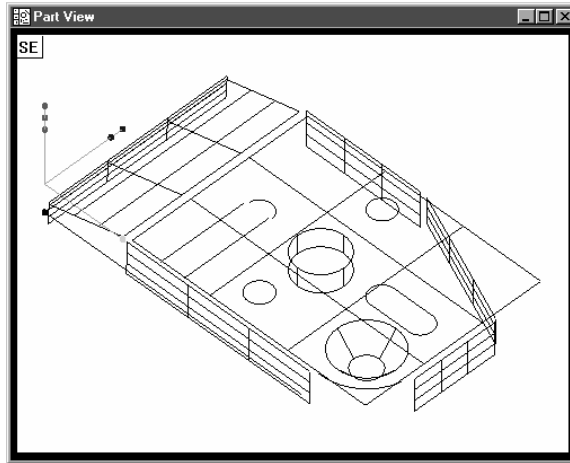

It is easy to use the QC5000 because each measurement requires only a few points. All geometry and mathematics are handled by the software. Once the basic measuring principles are understood the QC5000 can be programmed to handle repetitive measuring tasks. Finally, inspection and quality reports can be produced to document your results.



---

## About This Guide

This guide is intended for end users of the QC5000 metrology software, supervisory, and installation personnel. A basic familiarity with the Windows computing environment and coordinate measuring machine (CMM) operation is assumed. Material in this guide is divided into six chapters covering everything from basic operation to system configuration. Keep this guide in a convenient location for future reference.

### **Chapter 1: Overview**

It all begins here, just point and click. There are only two things in the QC5000 interface: windows and toolbars. This chapter tells you which is which and what to do with them. Understanding each window and toolbar helps you get the most from the QC5000.

### **Chapter 2: Quick Start**

This chapter gets you up and running quickly. Use this chapter to learn the most basic QC5000 tasks. Each task in this chapter is described in greater detail elsewhere in this guide.

### **Chapter 3: Using Probes**

If it's about probes, it's in this chapter. The probe is where the QC5000 and the coordinate measuring machine (CMM) meet. Learn proper probing techniques and you can't go wrong.

### **Chapter 4: General Measuring**

A solid knowledge of how to create and combine features to form a part is essential: this chapter helps you get it. Working from the basic to the complex, this chapter describes features and their relationships.

### **Chapter 5: Advanced Measuring & Output**

Picking up where chapter 4 leaves off this chapter covers datum magic, measure magic, layers, offset alignments, and tolerancing. This chapter also describes how to export QC5000 data to other software.

### **Chapter 6: Templates**

The QC5000 organizes and present data in a number of formats. For your convenience there are several data templates you can use to organize and present your results. Use this chapter to learn how to use templates more efficiently.

### **Chapter 7: Programming**

Programming puts it all together. This chapter shows you how to create a streamlined, computer-prompted procedure to handle repetitive inspections with speed and accuracy. Use the programming feature to maximize your productivity with the QC5000.

### **Chapter 8: System Setup & Configuration**

Everything you need to setup and configure the QC5000. This final chapter gives setup procedures for shift supervisors and OEMs. End users should apply the information in this chapter ONLY at the direction of a supervisor, distributor, or OEM.

### **Index**

There's nothing worse than skimming through a user guide looking for something when you're in a hurry. To save you the hassle we indexed this guide. Simply flip to the back, find your topic, and off you go.

## Chapter 1 Overview

### Icons and Type Faces

---

This guide uses the following icons and type faces to highlight information:

#### **Warning**

The lightning bolt icon warns of situations or conditions that can lead to personal injury or death. Do not proceed until you read and thoroughly understand a warning message. Warning messages are shown in bold type.

#### **Caution**

The exclamation point icon indicates situations or conditions that can lead to measurement error, equipment malfunction or damage. Do not proceed until you read and fully understand a caution message. Caution messages are shown in bold type.

#### **Note**

The note icon indicates additional or supplementary information about an activity or concept. Notes are shown in bold type.

**Warnings, cautions, and notes are shown in this typeface.**

#### **Italics**

*Italics* indicate menu items or button icons. For example,

Step 1

Select *customize* from the tools menu.



The italics instruct the user that *customize* is an item on the tools pull-down menu.

## Starting The QC5000

### To open the QC5000

#### Step 1



Double-click the QC5000 icon on the Windows NT desktop.

The following screen indicates that the program is loading. It takes a couple seconds for the program to load completely.



## Chapter 1 Overview

### Windows and Toolbars

The QC5000 uses a graphical user interface which means that instead of typing in a bunch of complicated commands you can do things by pointing and clicking the mouse.

In this manual we'll refer to the graphical user interface as the QC5000 desktop. Although setups may vary, a typical QC5000 desktop looks like this.

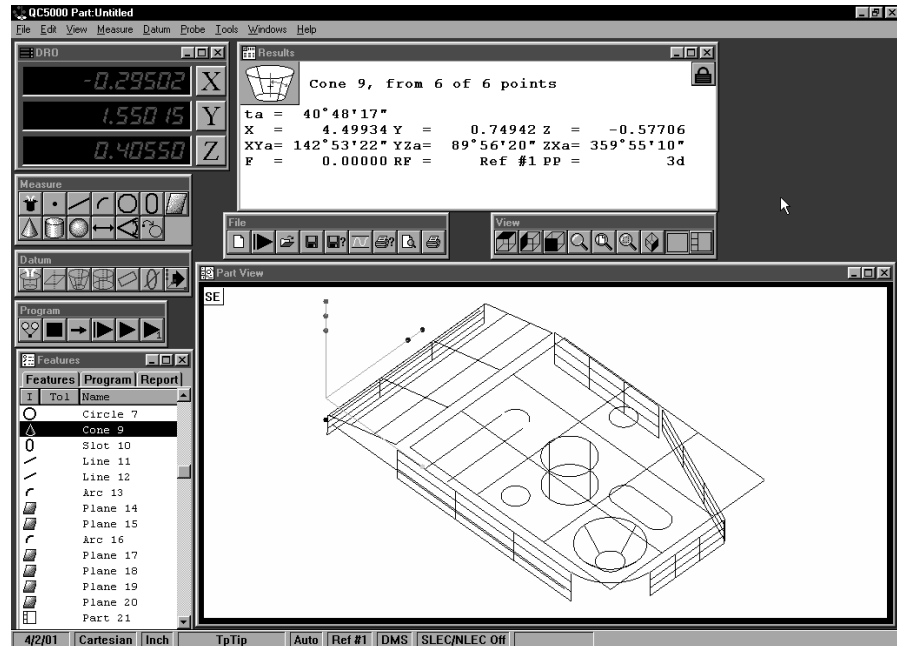

There are only two things to point and click at on the QC5000 desktop: windows and toolbars. Here's how to tell them apart.

Windows display information. Some windows contain buttons or require input but their basic function is to display information. For example, the part view window displays a graphic of the part.

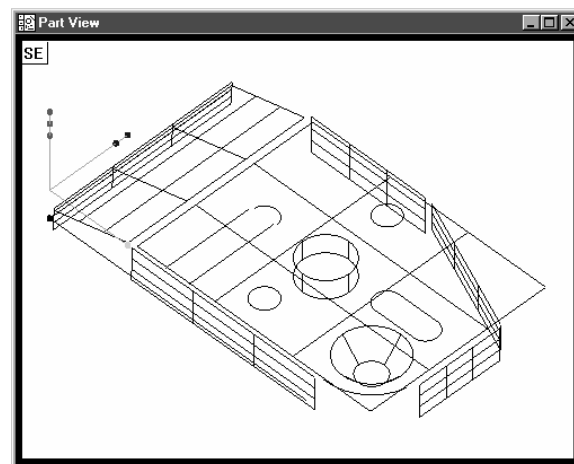

Toolbar contains buttons that execute common tasks. For example, the *measure* toolbar contains buttons for various measurement functions. To perform a measurement, click on the desired feature button (line, circle, plane, etc.).



## Chapter 1 Overview

### QC5000 Windows

The QC5000 desktop has four windows: DRO (digital readout), results, part view, and features list.

#### DRO

The DRO window displays the location of the X, Y, and Z axes (in mm or inches) from the datum. Click the button beside the respective axis to zero it.

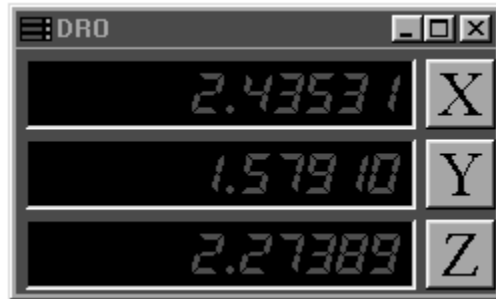

#### The Results Window

The results window displays the results of a feature measurement. This window contains the following:

- Feature specifications
- Lock/unlock feature
- Feature type diagram / feature stamp

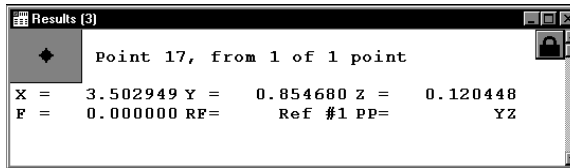

#### Feature Specifications

Feature information is displayed in the results window. Use the results window to add information to the features list.

**To move information from the results window to the features list**

Step 1

Highlight the desired information in the results window.

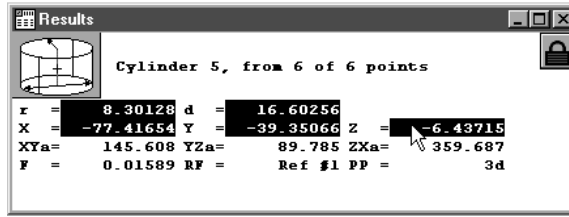

Step 2

Hold down the left mouse button and drag the information to the features list.

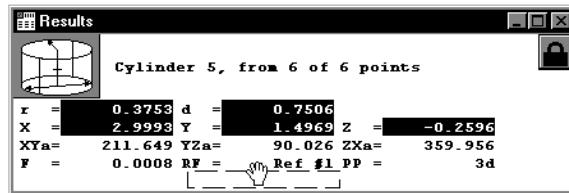

Step 3

Release the mouse button.

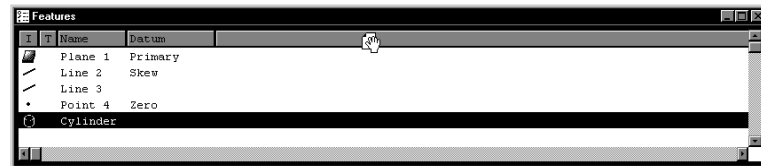

Step 4

Click the *as multiple new columns* button in the dialog box.



The feature window now displays the new parameters.

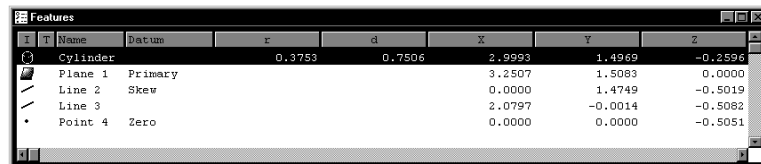

Information in this window is dependent on the type of feature. For example, the window shows radius/diameter values for spherical features but not for linear ones.

## Chapter 1 Overview

---

### Locked/unlocked features

Some parts use more than one reference frame to measure all its features. Locked features are displayed in their own reference frame. Unlocked features are displayed in the current reference frame.

### To unlock a feature

Step 1

Click the lock icon in the results window.



### To lock a feature

Step 1

Click the lock icon in the results window.

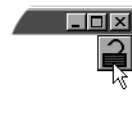



**Feature type diagram /feature stamp**

Clicking on the feature stamp icon opens the feature stamp window. The feature stamp window shows a graphic display of the feature and the distribution of the measurement points. Points discarded from the measurement are shown in red. Use the view toolbar to change the perspective in the feature stamp window.

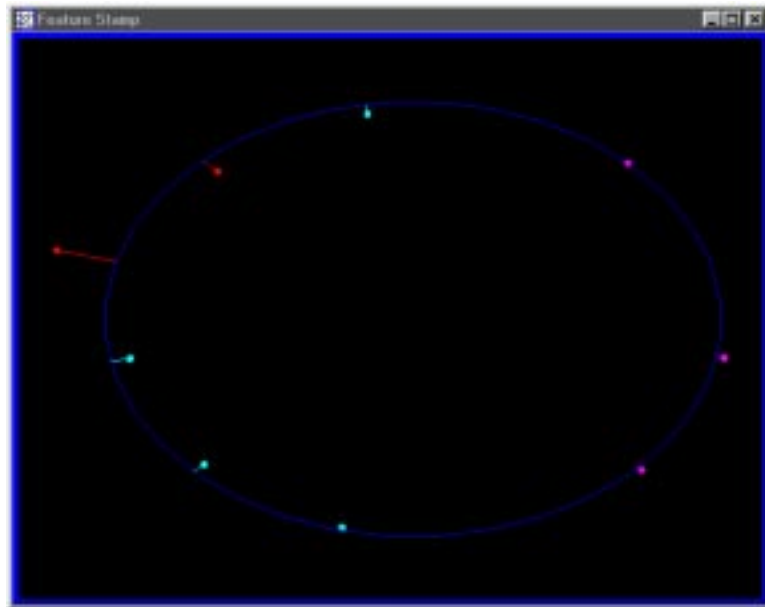

**To open the feature stamp window**

Step 1

Click the *feature stamp* button in the results window.

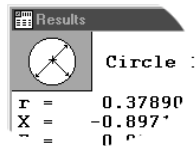

### The Part View Window

The part view window displays a graphical representation of the part and its features. Use the view toolbar to change the appearance of the part view window.



This is a typical view toolbar. Remember that QC5000 toolbars can be customized. Toolbars pictured in this guide may vary from those on your system.

Four pane part view displays the part from four separate vantage points. Highlighted panes are outlined in blue. Place the cursor on the pane and click to highlight. Only one pane can be highlighted at a time.

The most common part view window appearances are shown here.

#### Single pane part view

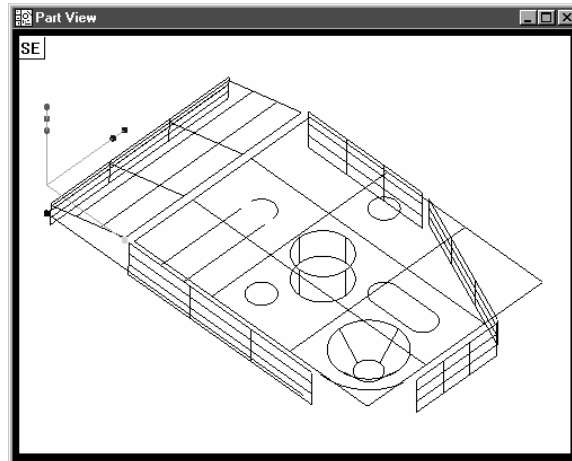

#### Four pane part view

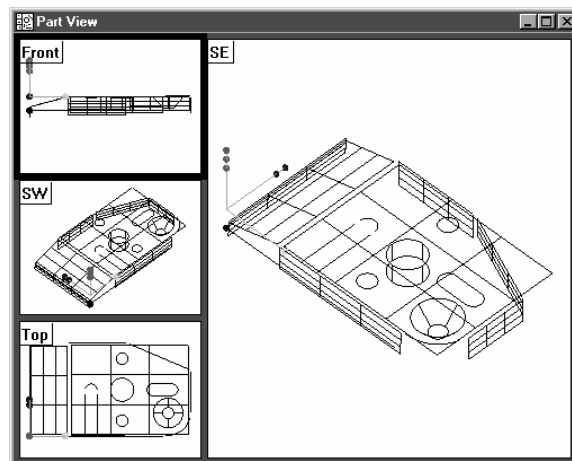

## View Rotator

Change the display angle of the part view window with the view rotator.

### To use the view rotator

Step 1



Click the *view rotator* button on the view toolbar OR select *view rotator* from the view menu..

Step 2

Place the cursor over the view rotator window as shown.

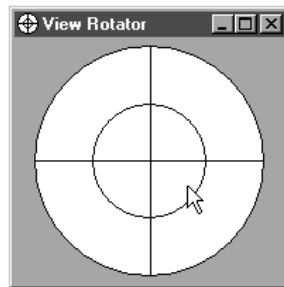

Step 3

Move the cursor over the view rotator window until the part is displayed as desired.

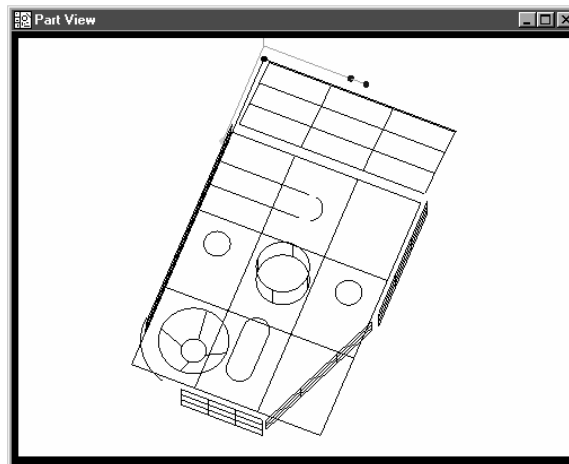

# Chapter 1 Overview

## Template Windows

Template windows display data output from QC5000 measurements and programs. See Chapter 4: *Advanced Measuring & Output* for more information on using template windows.

Nest templates windows as shown to conserve space on the QC5000 screen. For example, the window below contains the features, program, and report templates nested in a single window. View the desired template by selecting the proper tab. In the example below, the feature tab is selected.

I	T	Name	Datum	d	X	Y	r
✓		Arc 22		0.3746	1.9987	1.4973	0.1873
✓	Plane 3	Primary			3.2493	1.5449	
✓	Line 4	Skew			0.0000	1.4876	
✓	Line 5				2.1888	-0.0020	
•	Point 6	Zero			0.0000	0.0000	
✓	Plane 7				0.6532	1.5274	
✓	Plane 8				2.8808	0.0133	
✓	Arc 9			1.5157	4.4894	0.7543	0.7578
✓	Plane 10				5.2461	1.4748	
✓	Plane 11				4.2478	2.5456	
✓	Plane 12				2.1925	2.9965	
○	Cylinder			0.7532	2.9991	1.4966	0.3766
△	Cone 15				4.4987	0.7451	0.1758
○	Slot 16			0.3766	4.3122	1.4958	0.1883
○	Circle 17			0.3748	2.9987	0.4980	0.1874
○	Circle 18			0.3753	3.0002	2.4955	0.1877
✓	Line 19				2.1875	0.7438	
✓	Line 20				1.8106	0.7482	

### To separate template windows

#### Step 1

Place the cursor over the desired tab as shown.

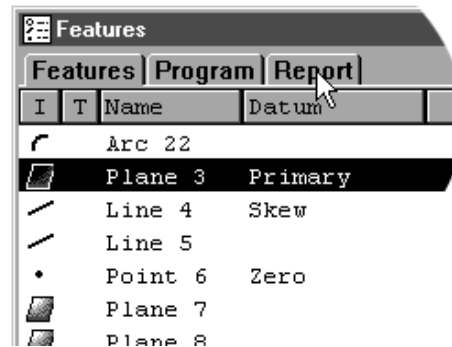

#### Step 2

Hold the left mouse button and drag the tab outside the current window as shown.

I	T	Name	Datum	d	X	Y	r
✓		Arc 22		0.3746	1.9987	1.4973	0.1873

I	T	Feature	Position/Dim.	Size	Orientation	Form/Dim.	Spec
✓	Lin	3	X	3.2493	XY<	0.000 F	0.0000
✓	Pla	Plane 3	Y	1.5449	YZ<	90.000	
✓	Pla	Plane 3	Z	0.0000	ZX<	0.000	
✓	Pla	Plane 4	X	0.0000	XY<	90.000 F	0.0000
✓	Pla	Plane 4	Y	1.4876	YZ<	0.000	
✓	Pla	Plane 5	Z	-0.5046	ZX<	0.000	
✓	Pla	Plane 5	X	2.1888	XY<	179.949 F	0.0000
✓	Pla	Plane 5	Y	-0.0020	YZ<	0.000	
✓	Pla	Plane 5	Z	-0.5042	ZX<	90.000	
✓	Pla	Plane 6	X	0.0000		F	0.0000
✓	Pla	Plane 6	Y	0.0000			
✓	Pla	Plane 6	Z	-0.5044			
✓	Pla	Plane 7	X	0.6532	XY<	180.350 F	0.0000
✓	Pla	Plane 7	Y	1.5274	YZ<	90.093	
✓	Pla	Plane 7	Z	-0.1672	ZX<	345.037	
✓	Pla	Plane 8	X	2.8808	XY<	269.913 F	0.0000
✓	Pla	Plane 8	Y	0.0133	YZ<	176.801	
✓	Pla	Plane 8	Z	-0.2467	ZX<	358.459	
✓	Pla	Plane 9	X	4.4894	XY<	1.5157	L3d 0.0550
✓	Pla	Plane 9	Y	0.7543	YZ<	0.7578	F 0.0000

Step 3  
Release the left mouse button.

#	Feature	Position/Dir	Size	Orientation	Para/Dir	Count
3		1.2450		23<	0.800 F	0.0080
Phase 3	T	1.2449		12<	50.800	
	T	0.0006		23<	0.800	
	Z					
4		0.0008		23<	50.800 F	0.0080
Line 4	T	1.9876		12<	0.800	
	T	-0.5046		23<	0.800	
	Z					
5		2.1888		23<	179.247 F	0.0080
Line 5	T	-0.0011		12<	0.800	
	T	-0.5042		23<	50.800	
	Z					
6		0.0008			F	0.0080
Phase 6	T	0.0008				
	T	-0.5044				
	Z					
7		0.4512		23<	350.350 F	0.0080
Phase 7	T	1.5274		12<	50.889	
	T	-0.1872		23<	345.807	
	Z					
8		2.9808		23<	249.313 F	0.0080
Phase 8	T	0.0113		12<	376.801	
	T	-0.2467		23<	359.459	
	Z					
9		4.9894	A	1.5157	L3d	0.0680
Line 9	T	0.7543	C	0.1576	F	0.0080

## To nest template windows

### Step 1

Place the cursor over the desired template window as shown.

#	Feature	Position/Dim.
3		X 3.2493
Plane 3		Y 1.5449
		Z 0.0000
Line 4		X 0.0000
		Y 1.4876
		Z -0.0000
Line 5		X 2.1888
		Y -0.0020
		Z -0.5042
6		

### Step 2

Hold the left mouse button and drag the template over the desired window.

#	Feature	Position/Dim.	Size	Orientation	Form/Dim.	Spec
3		X 3.2493		XY<	0.000 F	0.0000
Plane 3		Y 1.5449		YZ<	90.000	
		Z 0.0000		ZX<	0.000	
Line 4		X 0.0000		XY<	90.000 F	0.0000
		Y 1.4876		YZ<	0.000	
		Z -0.5042		ZX<	0.000	
Line 5		X 2.1888		XY<	179.547 F	0.0000
		Y -0.0020		YZ<	0.000	
		Z -0.5042		ZX<	90.000	
Point 6		X 0.0000			F	0.0000
		Y 0.0000				
		Z -0.5044				
Plane 7		X 0.6532		XY<	180.350 F	0.0000
		Y 1.5274		YZ<	90.093	
		Z -0.1672		ZX<	345.007	
Plane 8		X 2.8808		XY<	269.913 F	0.0000
		Y 0.0133		YZ<	174.601	
		Z -0.2467		ZX<	358.459	
Arc 9		X 4.4896	d 1.5157		L3d	0.0550
		Y 0.7543	z 0.7578		F	0.0000

### Step 3

Release the mouse button.

#	Name	Datum	d	X	Y	z
Arc 22			0.3746	1.9987	1.4973	0.1873
Plane 3	Primary			3.2493	1.5449	
Line 4	Skew		0.0000	1.4876		
Line 5			2.1888	-0.0020		
Point 6	Zero		0.0000	0.0000		
Plane 7			0.6532	1.5274		
Plane 8			2.8808	0.0133		
Arc 9			1.5157	4.4896	0.7543	0.7578
Plane 10			5.2461	1.4748		
Plane 11			4.2478	2.5456		
Plane 12			2.1925	2.9965		
Cylinder			0.7532	2.9991	1.4966	0.3766
Cone 15			4.4987	0.7451		0.1758
Slot 16			0.3766	4.3122	1.4958	0.1883
Circle 17			0.3748	2.9987	0.4980	0.1874
Circle 18			0.3753	3.0002	2.4955	0.1877
Line 19				2.1875	0.7438	
Line 20				1.8106	0.7482	

## Status Bar

The status bar runs across the bottom of the screen and displays such as:

- Date
- Type of coordinates (Polar/Cartesian)
- Selected units of measurement (in./mm)
- Active Layer
- Active probe tip
- Projection Plane
- Active Reference Frame
- Angle Display Mode
- SLEC Status
- Recording or Editing Mode

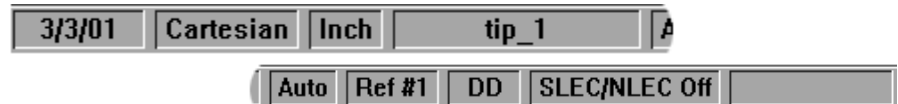

Use the status bar to toggle between settings. Place the cursor over the mm/inch section of the status bar. Click the mouse to toggle between inches and millimeters. This is a quick way to change the units of measure. Other settings in the status bar can be toggled in the same way.

### To add items to the status bar

#### Step 1

Select *customize* from the tools menu.

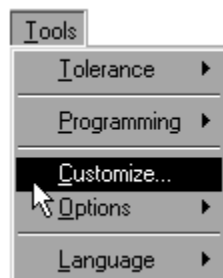

#### Step 2

Select the *status bar* tab as shown.

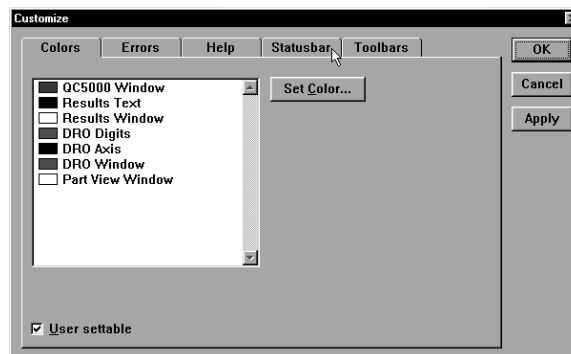

Step 3  
Highlight the desired item as shown.

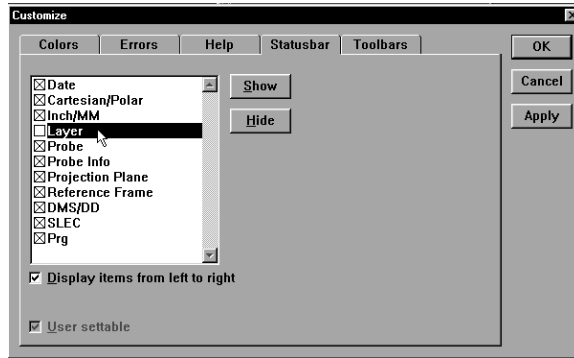

**NOTE**

Items currently in the status bar have an 'X' in the box next to them. An empty box indicates the item is currently not on the status bar.

Step 4  
Click the *show* button.

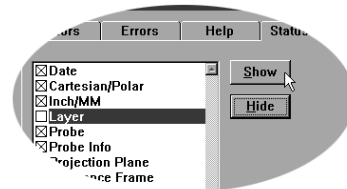

Step 5  
Click OK.

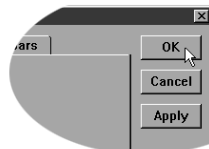



**To delete items from the status bar**

Step 1  
Select *customize* from the tools menu.

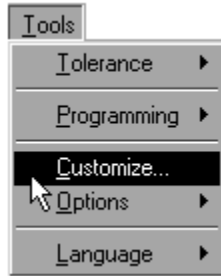

Step 2  
Select the *status bar* tab as shown.

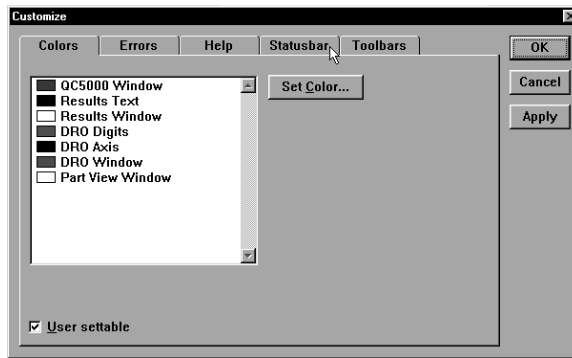

Step 3  
Highlight the desired item as shown.

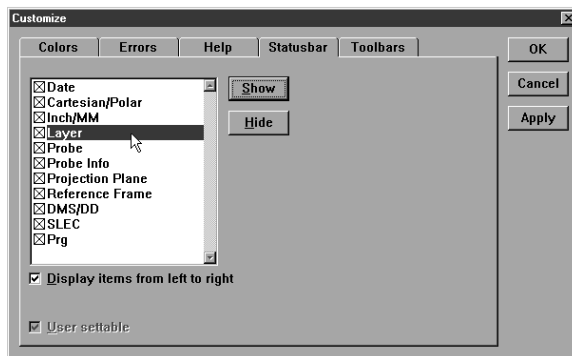

**NOTE**

Items currently in the status bar have an 'X' in the box next to them. An empty box indicates the item is currently not on the status bar.

## Chapter 1 Overview

---

Step 4  
Click the *hide* button.

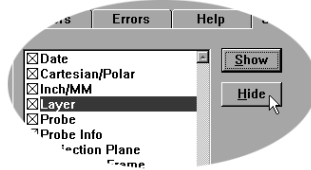

Step 5  
Click OK.

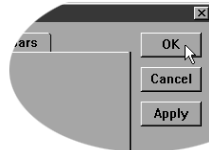

## Main Menu Bar

This section shows the content of the QC5000 pull-down menus. A discussion of the various menu commands follows in later chapters. Use this section to familiarize yourself with the menus. Place the cursor over the desired menu and click to view pull-down menus.

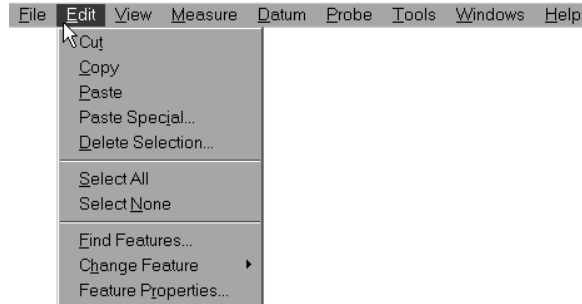

The main menu bar contains the following pull down menus:

### File



Use the *file* menu to access the following commands:

- New
- Open
- Save
- Save As
- Import
- Export
- DDE Output (dynamic data exchange)
- Page Setup
- Print Preview
- Print
- Exit

### Edit

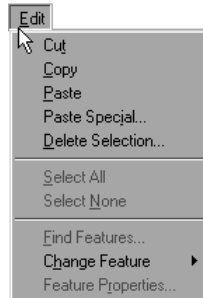

Use the *edit* menu to access the following commands:

- Cut
- Copy
- Paste
- Paste Special
- Delete Selection
- Select All
- Select None
- Find Features
- Change Feature
- Features Properties

### View

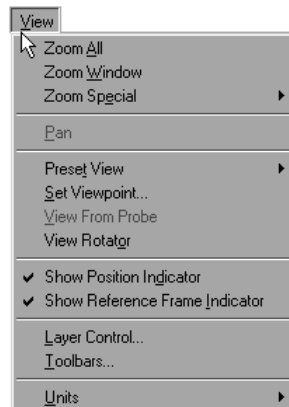

Use the *view* menu to access the following commands:

- Zoom All
- Zoom Window
- Zoom Special
- Pan
- Preset View
- Set Viewpoint
- View From Probe
- View Rotator
- Show Position Indicator
- Show Reference Frame Indicator
- Layer Control
- Toolbars....
- Units

## Measure

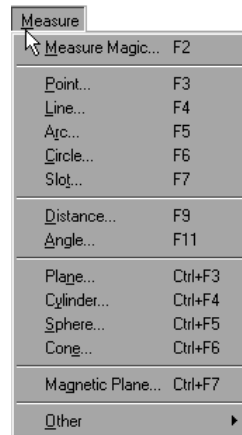

Use the *measure* menu to access the following commands:

- Measure Magic
- Point
- Line
- Arc
- Circle
- Slot
- Distance
- Angle
- Plane
- Cylinder
- Sphere
- Cone
- Magnetic Plane
- Other

## Datum

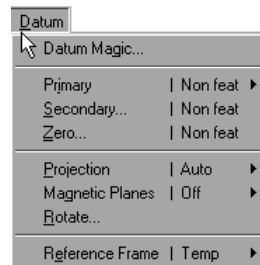

Use the *datum* menu to access the following commands:

- Datum Magic
- Primary
- Secondary
- Zero
- Projection
- Magnetic Planes
- Rotate
- Reference Frame

### Probe

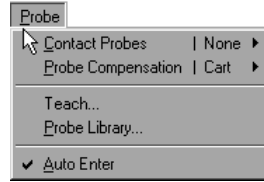

Use the *probe* menu to access the following commands:

- Contact Probes
- Probe Compensation
- Teach
- Probe Library
- Auto Enter

### Tools

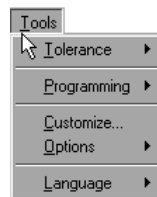

Use the *tools* menu to access the following commands:

- Tolerance
- Programming
- Customize
- Options
- Language

### Windows

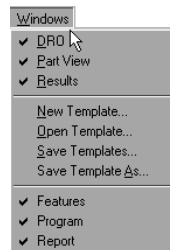

Use the *windows* menu to access the following commands:

- DRO
- Part View
- Results
- New Template...
- Open Template...
- Save Templates As
- Features
- Program
- Report

## Help

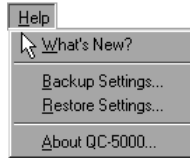

Use the *help* menu to access the following commands:

- What's New?
- Backup Settings
- Restore Settings
- About QC5000

## Chapter 1 Overview

### Toolbars

---

Toolbars contain buttons that execute common tasks. Use toolbars instead of hunting through pull-down menus for commands. Simply click the desired button and the task is begun. Toolbars correspond to the main menu. For example, buttons in the view toolbar correspond to commands on the view menu.

#### Datum toolbar

Use the *datum* toolbar to establish datums and reference frames. Buttons in the *datum* toolbar correspond to items on the *datum* menu.



#### Measure toolbar

Use the *measure* toolbar to measure and construct features. Buttons on the *measure* toolbar correspond to items on the *measure* menu.



#### Probe toolbar

Use the *probe* toolbar to access probe functions and settings. Buttons on the *probe* toolbar correspond to items on the *probe* menu.



#### View toolbar

Use the *view* toolbar to adjust the part view window. Buttons on the *view* toolbar correspond to items on the *view* menu.



#### Tolerance toolbar

Use the *tolerance* toolbar to perform tolerances on selected features. Buttons on the *tolerance* toolbar correspond to items on the *tools* menu.



#### Program toolbar

Use the *program* toolbar to access programming functions. Buttons on the *program* toolbar correspond to items on the *tools* menu.



#### File toolbar

Use the *file* toolbar to access file functions. Buttons on the *file* toolbar correspond to items on the *file* menu.





**To place a toolbar on the QC5000 desktop**

Step 1  
Select *toolbars* from the view menu.

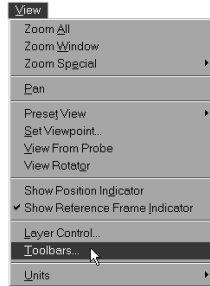

Step 2  
Highlight the desired toolbar as shown.

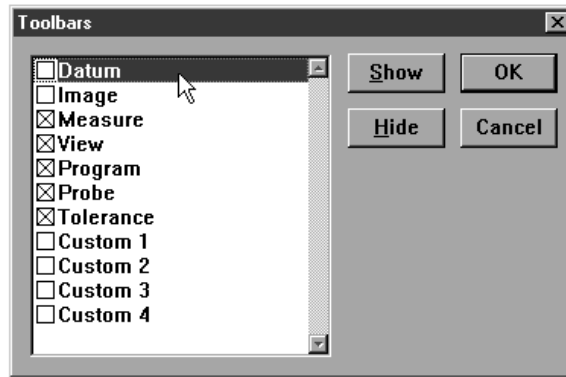

**NOTE**

Toolbars on the QC5000 desktop have an 'X' in the box next to them. An empty box indicates the item is currently **NOT** on the desktop.

Step 3  
Click the *show* button.

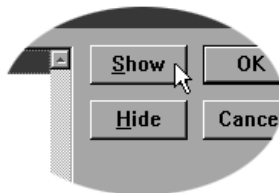

## To remove a toolbar from the QC5000 desktop

### Step 1

Select *toolbars* from the view menu.

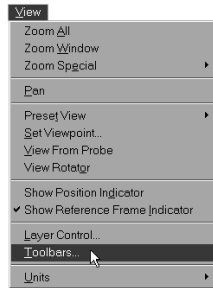

### Step 2

Highlight the desired toolbar as shown.

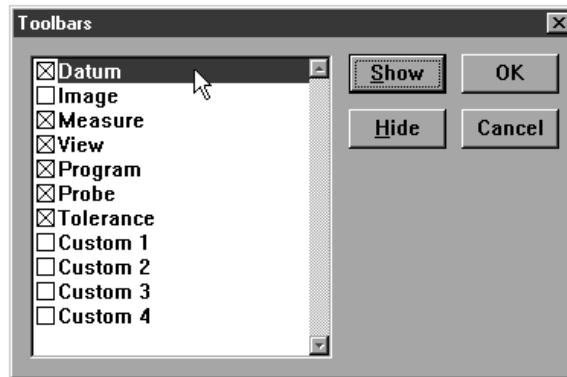

### NOTE

Toolbars on the QC5000 desktop have an 'X' in the box next to them. An empty box indicates the item is currently NOT on the desktop.

### Step 3

Click the *hide* button.

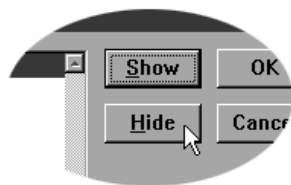

Customize your toolbars by adding or deleting buttons. Add buttons for common tasks. Delete seldom used buttons to keep toolbar size manageable.

**To add buttons to a toolbar**

Step 1  
Select *customize* from the tools menu.



Step 2  
Select the *toolbars* tab in the customize dialog box.

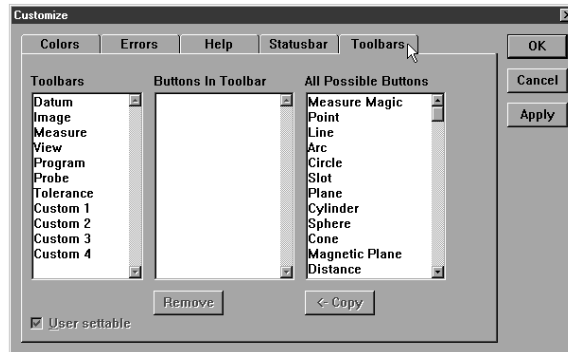

Step 3  
Highlight the desired toolbar in the *toolbars* list as shown.

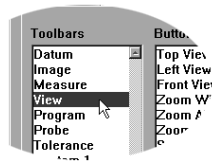

Step 4  
Highlight the desired button in the *all possible buttons* list.

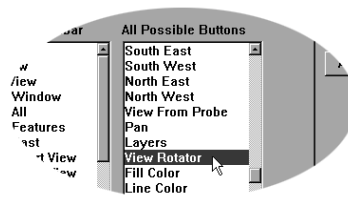

## Chapter 1 Overview

---

Step 5  
Click the *copy* button.



Step 6  
Click OK.

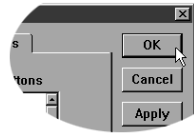

To remove buttons to a toolbar

Step 1  
Select *customize* from the tools menu.



Step 2  
Select the *toolbars* tab in the customize dialog box.

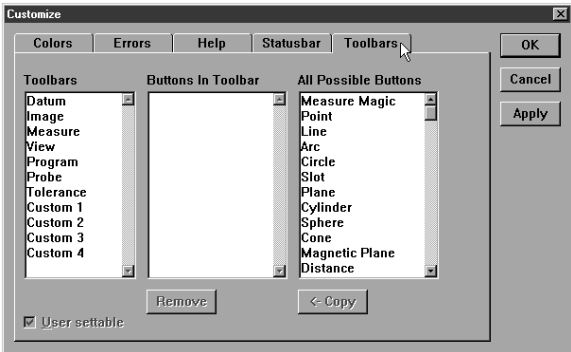

Step 3  
Highlight the desired toolbar in the *toolbars* list as shown.

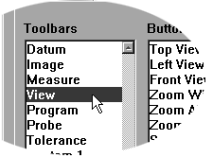

Step 4  
Highlight the desired button in the *buttons in toolbar* list.

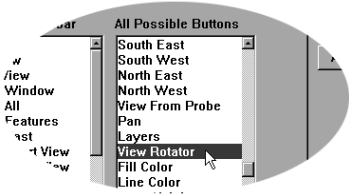

Step 5  
Click the *remove* button.

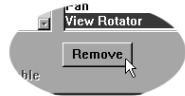

Step 6  
Click OK.



# Chapter 2

## Quick Start

---

### Quick Start

Use the *quick start* chapter to begin using the QC5000 immediately. This chapter will describe the most common user tasks associated with the QC5000. More detailed explanations for each task are found in subsequent chapters of this guide.

#### Set machine zero

##### Step 1

Double-click the QC5000 icon on the Windows NT desktop.



##### Step 2

Move the axes of the CMM to the machine zero position (consult the CMM user guide for more information) when the dialog box appears on the screen.

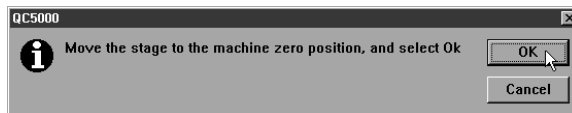

##### Step 3

Click OK in the dialog box.

#### CAUTION

**Set machine zero every time you begin a QC5000 session. Machine zero is used by QC5000 for SLEC (segmented linear error correction) functions. If machine zero is not set, SLEC functions will not work properly.**

**Create a reference frame**

Step 1

Click the primary plane button on the datum toolbar.

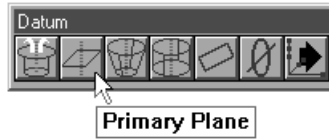

Step 2

Measure three points on the plane as shown.

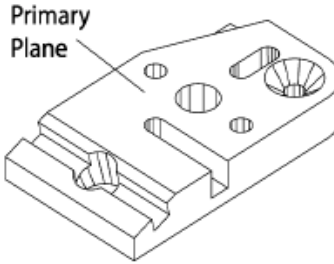

Step 3

Click OK in the dialog box.

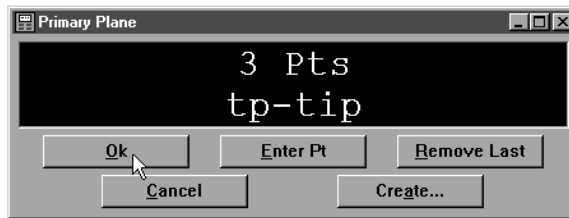

Step 4

Click the secondary line button on the datum toolbar.

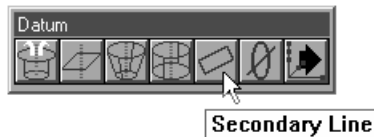

Step 5

Probe two points on the secondary line. Space the points close to the opposite ends of the line.

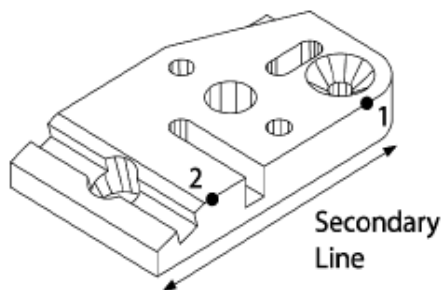



Step 6  
Click OK in the dialog box.

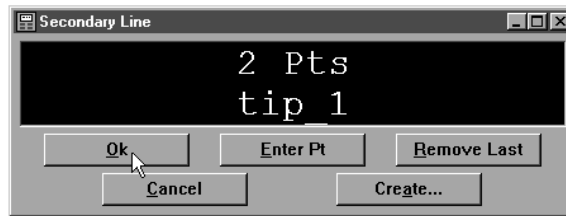

Step 7  
Click the line button on the measure toolbar.

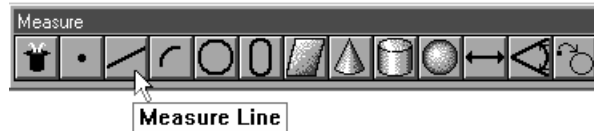

Step 8  
Probe two points along the tertiary alignment as shown.

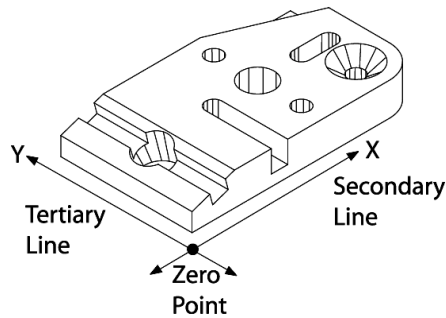

Step 9  
Click OK in the dialog box.

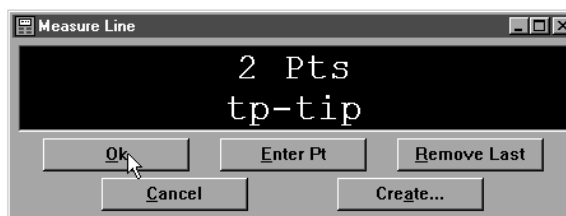

Step 10  
Click the zero point button on the datum toolbar.

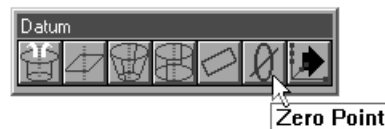

### Step 11

Use the mouse to highlight the secondary and tertiary lines in the features list.

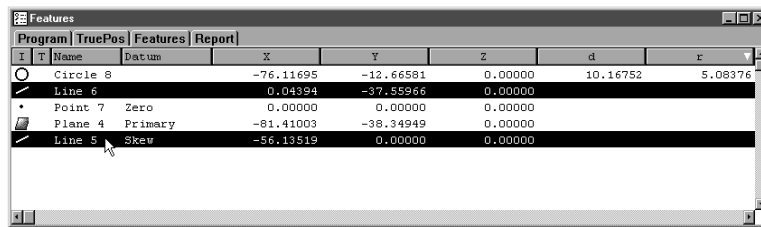

I	T	Name	Datum	X	Y	Z	d	r
		Circle 8		-76.11695	-12.66581	0.00000	10.16752	5.08376
✓		Line 6		0.04394	-37.55866	0.00000		
•		Point 7	Zero	0.00000	0.00000	0.00000		
		Plane 4	Primary	-81.41003	-38.34949	0.00000		
✓		Line 5	Skew	-56.13519	0.00000	0.00000		

### Step 12

Click OK in the dialog box.

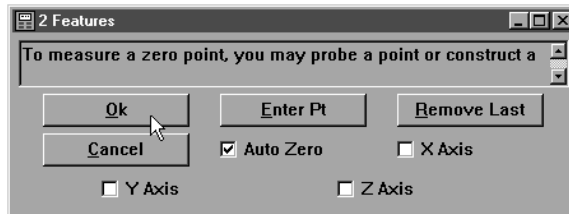

**Measure a line (minimum 2 points)**

Step 1  
Probe two points on the line as shown.

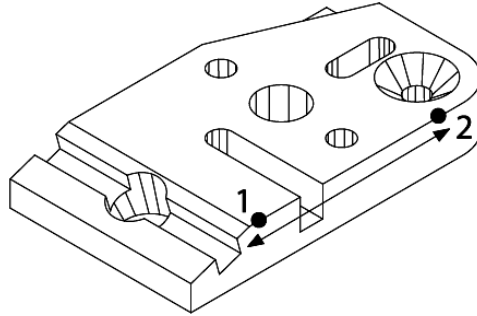

Step 2  
Click OK in the dialog box.



**Measure a circle (minimum 3 points)**

Step 1  
Probe three points on the circle as shown.

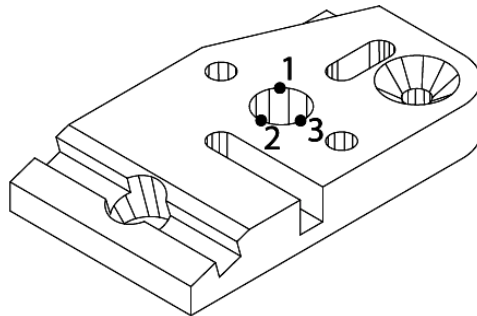

Step 2  
Click OK in the dialog box.



**Measure a cone (minimum 6 points)**

Step 1

Probe six points on the cone as shown.

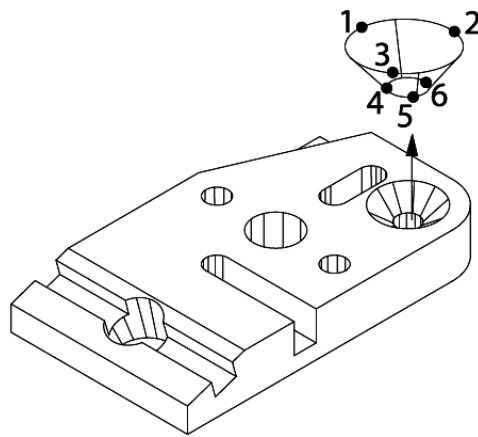

Step 2

Click OK in the dialog box.



**Measure a cylinder (minimum 6 points)**

Step 1  
Probe six points on the cylinder as shown.

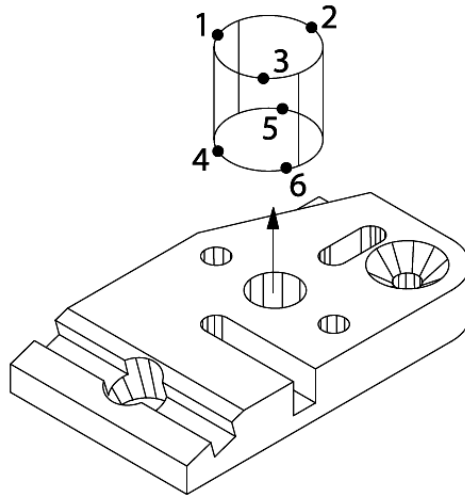

Step 2  
Click OK in the dialog box.



### Measure a distance

#### Step 1

Highlight two linear feature on the features list.

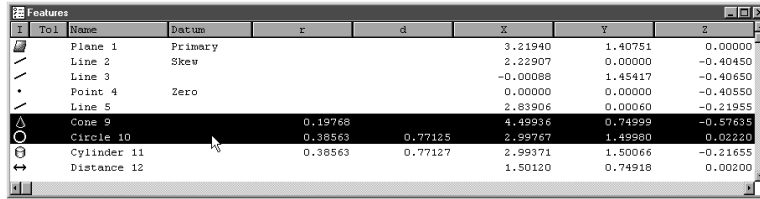

Icon	Feat	Name	Datum	r	d	X	Y	Z
Plane	Plane 1	Primary				3.21940	1.40751	0.00000
Line	Line 2	Skew				2.22907	0.00000	-0.40450
Line	Line 3					-0.00088	1.45417	-0.40660
Point	Point 4	Zero				0.00000	0.00000	-0.40550
Line	Line 5					2.83906	0.00060	-0.21955
Cone	Cone 9			0.19768		4.49916	0.74999	-0.57635
Circle	Circle 10			0.38563	0.77125	2.99767	1.49980	0.02220
Cylinder	Cylinder 11			0.38563	0.77127	2.99371	1.50066	-0.21655
Distance	Distance 12					1.50120	0.74918	0.00200

#### Step 2

Click the distance button on the measure toolbar.



#### Step 3

Click OK in the dialog box.

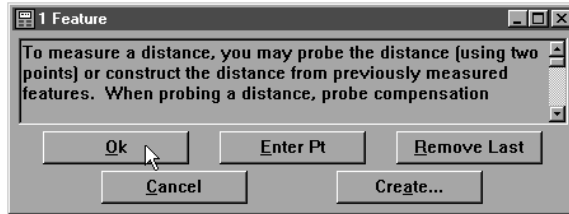

### Save a part file

#### Step 1

Select save as from the file menu.

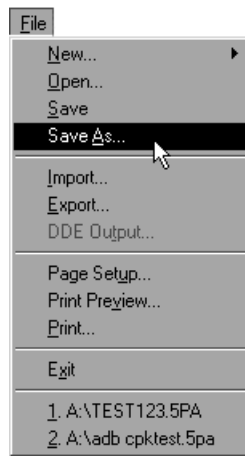

#### Step 2

Type a name for the part file in the file name text box in the dialog box.

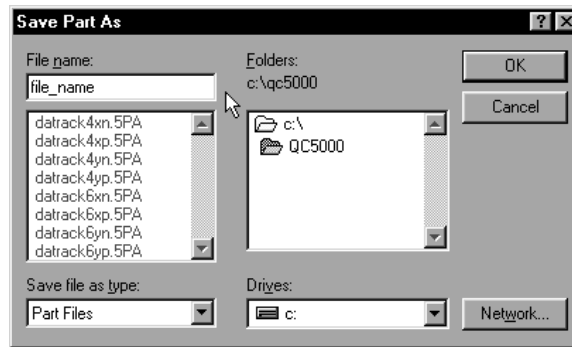

#### Step 3

Select a storage location for the file using the folders box and/or drives box.

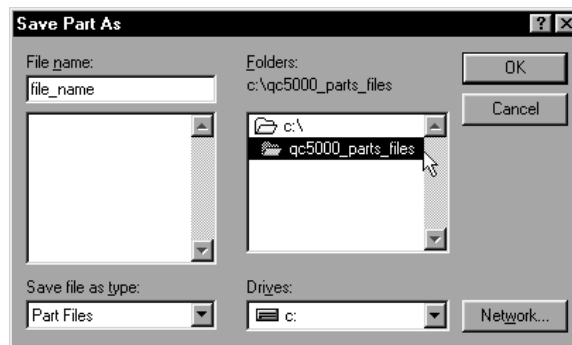

Step 4  
Click OK in the dialog box.

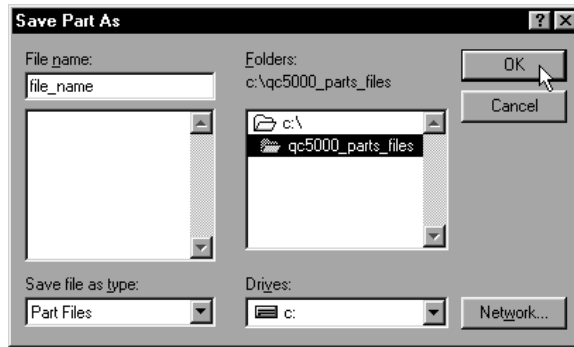



# Chapter 3

## Using Probes

---

### Probing Technique

Probing technique refers to the method of moving CMM axes and entering point data with a touch probe. All features are made up of points and all points are taken with probes. In order to get good results from the QC5000 software it is important to use proper probe technique and to input proper probe settings.

#### Good probing techniques

- approach the feature from a 90 degree angle
- approach the feature from a distance of at least 1mm
- do not probe a feature from an angle of 45 degrees or less

#### Bad probing techniques

- dragging probe across a part
- dropping probe off the edge of a part

### Probe Toolbar

The probe toolbar contains several buttons for initiating probe functions.



- Probe teach
- Probe compensation
- Cardinal probe compensation
- Polar probe compensation
- Auto enter
- Probe library

#### Probe teach

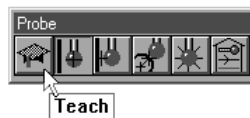

Click the probe teach button to begin the calibration of a probe tip.

#### Probe compensation off



Click the probe compensation button to toggle off probe compensation.

### Cardinal probe compensation



Click the cardinal probe compensation button to toggle on/off probe cardinal compensation. Use cardinal probe compensation for general measuring of features to apply compensation for the probe tip radius in the probe direction.

### Polar probe compensation



Click the polar probe compensation button to toggle on/off polar probe compensation. Use polar probe compensation for probing point features in polar coordinate mode.

### Auto enter



Click the auto enter icon to toggle on/off auto enter. Use auto enter to automatically enter a point from a touch probe upon contact.

### Probe library



Click the probe library button to access the probe library window.

## Probe compensation

Use the probe compensation feature to allow for less than perfect probe technique. It is simple enough to use good probe technique when measuring flat features. Features on angled surfaces are more difficult.

Since perfect technique is difficult to achieve even on flat surfaces use probe compensation all measurements. Probe compensation makes up for less than perfect probe technique; it does not make up for bad probe technique.

Click the probe compensation button on the probe toolbar to toggle on/off probe compensation. Probe compensation is the amount of offset applied for the diameter of the probe tip. The direction compensation is applied is determined by the direction the probe travels immediately before taking a point.

### Probe compensation off



Click the probe compensation button to toggle off probe compensation. Use probe compensation off to turn off probe or cardinal compensation.

### Cardinal probe compensation



Click the cardinal probe compensation button to toggle on/off probe cardinal compensation. Use cardinal probe compensation for general measuring of features to apply compensation for the probe tip radius in the probe direction.

### Polar probe compensation



Click the polar probe compensation button to toggle on/off polar probe compensation. Use polar probe compensation for probing point features in polar coordinate mode.

To activate probe compensation

Step 1

Click the *polar* or *cardinal probe compensation* button on the probe toolbar.



OR

Step 1

Select *probe compensation* from the probes menu.

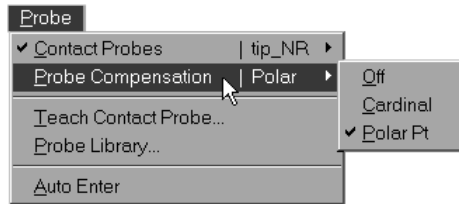

Step 2

Select *cardinal* or *polar* from the submenu as shown.

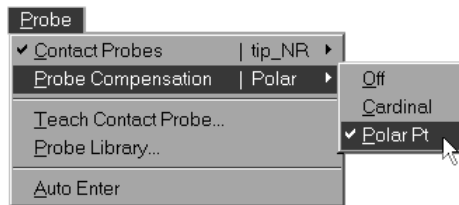

## Auto Enter

The simplest way to enter points is to use Auto Enter. Auto Enter records each probe hit as a point. This allows point entry without keyboard, mouse, or footswitch input after each probe hit.



**Auto Enter does not work with hard probes.**

### To activate auto enter

Step 1

Click the *auto enter* button on the probe toolbar.



**The *auto enter* button remains depressed on the probe toolbar while activated.**

OR

Step 1

Select *auto enter* from the probes menu.

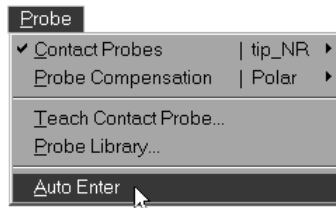

**A check-mark appears next to auto enter on the menu when active.**

## Probe Library

Probe library organizes all the probes used with the QC5000 software. Use probe library to set up and manage probes and probe settings.

Probe set up functions include

- creating probe groups
- designating a master probe

Management functions include

- storing reference offset data
- storing probe qualification data
- adding/deleting probes from groups

## Chapter 3 Using Probes

### Probe Families & Groups

Click the tool library button on the probe toolbar to view the tool library dialog box. Probes are organized into families and groups. Families consist of groups. Groups consist of probes.

Probe families organize similar probe groups. For example, the contact probes family contains the groups: HardProbe, TouchProbe, StarProbe.



**NOTE**  
QC5000 metrology software for manual CMMs uses only the contact probes family. New probe families cannot be created.

Click on the plus (+) sign next to the contact probes family.

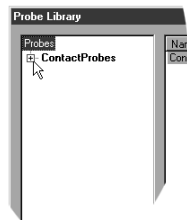

Observe the three default probe groups: HardProbe, TouchProbe, StarProbe.

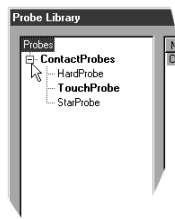

#### HardProbe group

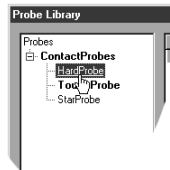

Hard probes have no internal switching mechanism to detect contact with the part. User simply position a hard probe in contact with the part and manually enters the point.

### TouchProbe group

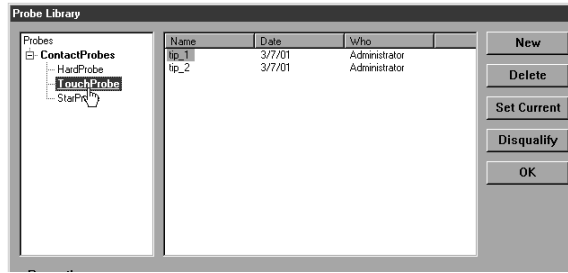

Touch probes have an internal switch that sends an electrical signal when the probe contacts the part. This electronic signal allows the auto-enter feature of the QC5000 to automatically enter the point.

### StarProbe group

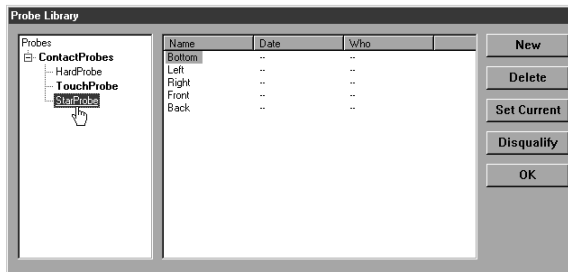

Star probes are actually a variant of touch probes. Each star probes have five tips arranged bottom, left, right, front, and back. These tips appear by default in the StarProbe group.

### To create a new probe group

#### Step 1

Highlight the desired probe family for the new group.

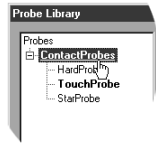

#### Step 2

Click on the *new* button.

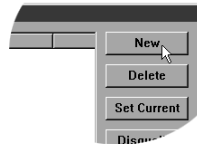

#### Step 3

Type a name for the group in the *name* text box.

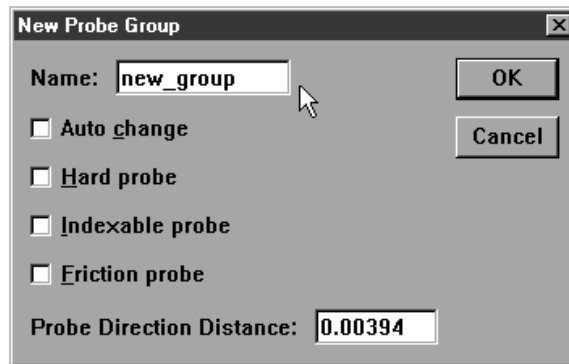

#### Step 4

Check the *auto change* box for probes interchangeable with other groups. If using an indexable or friction probe check the appropriate box otherwise proceed to step 4.

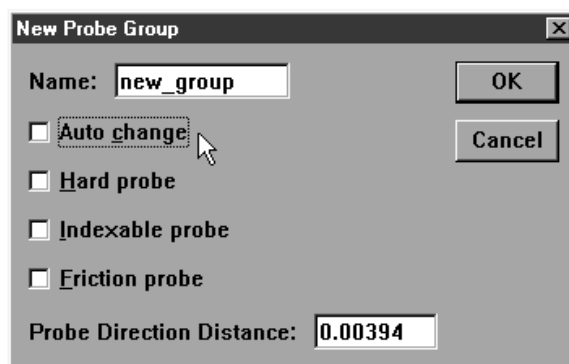

#### Step 4

Enter the distance the probe must travel in a direction prior to making contact with the part in the probe direction distance text box.



**New Probe Group** [X]

Name:

Auto change

Hard probe

Indexable probe

Friction probe

Probe Direction Distance:



**NOTE**

Probe direction distance determines in which direction probe compensation is applied.

### Probe Calibration

There are two factors that influence probe measurements: the radius of the probe tip and the spatial (X, Y, and Z) position of the probe tip. All measurements are based on the location of the center of the probe tip. Probe compensation applies a calculation to correct for the radius of the probe on each measurement. The compensation for each probe tip is calculated automatically when the probe is taught.

Click on the TouchProbe group and observe the probes in the right-hand data box. The following information appears in the probe data box by default name of the probe, date of probe qualification, and the name of the person who performed the qualification.

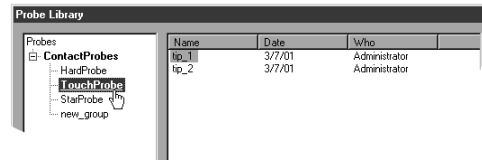

Name	Date	Who
tip_1	3/7/01	Administrator
tip_2	3/7/01	Administrator

#### NOTE

**The date and the name of the person qualifying the probe are taken from the Windows system clock and login respectively.**

Probe qualification, or probe teaching, refers to the process of establishing the dimension of the probe tip. This process typically involves taking a number of probe hits on a qualification sphere with a known diameter. Qualifying, or teaching, a probe also provides offsets for probe compensation.

#### Master probe tips

Teaching a probe also establishes the spatial (X, Y, and Z) position of the probe tip (master probe tip) or the X, Y, and Z offsets (non-master tips) from the master tip. Each probe group has one master probe tip. The X, Y, and Z values of each probe in a group is compared to the master probe. The difference becomes the X, Y, and Z offset value for each non-master probe tip.

For example, a star probe group has five probe tips: one master tip and four non-master tips. The X, Y, and Z position on the non-master tips are all calculated by their X, Y, and Z offset from the master tip. Since the tips on a star probe are fixed and repeatable simply re-teaching the master tip is sufficient to update the entire group.

The same holds true for index probes that can be moved into various repeatable positions. Each position can be entered into probe library as a new tip. Establishing one position as the master tip allows all the non-master tips (positions) to update when the master tip is re-taught.

**To teach (qualify) a master probe tip**

Step 1  
Highlight the desired probe as shown.

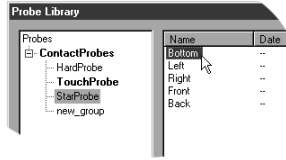

Step 2  
Check the *reference offset* checkbox as shown.

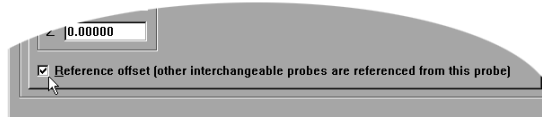

Step 3  
Click on the *teach* button.

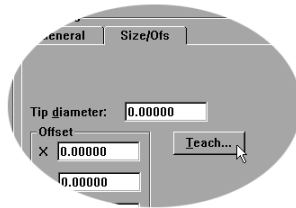

Step 4  
Probe the qualification sphere as shown.

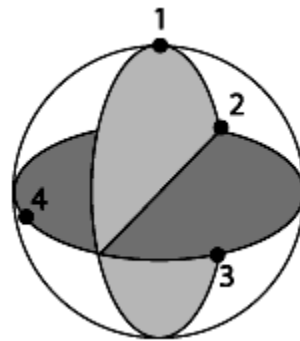

**NOTE**

**4 points are the minimum required for a sphere measurement. Use more points to increase the accuracy of your measurements.**

Step 5  
Click OK in the dialog box.



To teach (qualify) a non-master probe tip

Step 1  
Highlight the desired probe as shown.

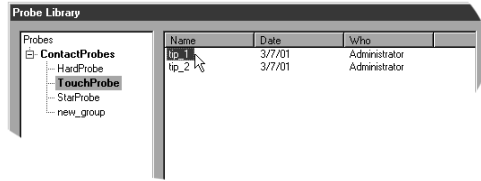

Step 2  
Click the *teach* button.

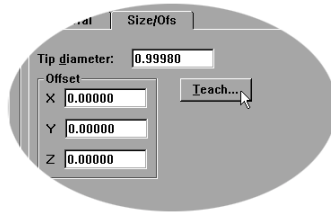

Step 3  
Probe the qualification sphere as shown.

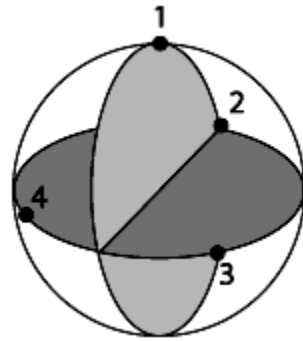

 NOTE

4 points are the minimum required for a sphere measurement. Use more points to increase the accuracy of your measurements.

Step 4  
Click OK in the dialog box.



## Changing Probes

There are a number of ways to select different probes. This section shows how to view available probes, change probes, and add/delete probes.

### To view the probes in a group

Step 1

Click the *probe library* button on the probe toolbar.



Step 2

Click on the plus sign to view the groups in the family.

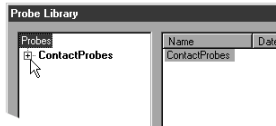

### To change the current probe tip

Step 1

Click the *probe library* button on the probe toolbar.



Step 2

Click on the plus sign next to the desired group in the left-hand box.

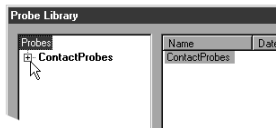

Step 3

Highlight the desired group.

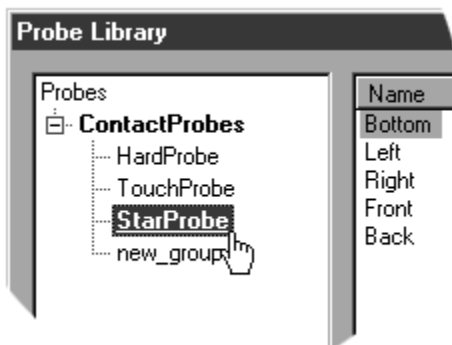

## Chapter 3 Using Probes

Step 4  
Highlight the new probe tip as shown.

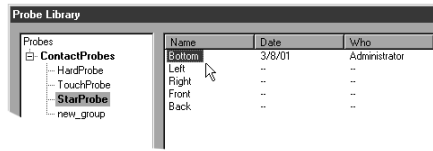

Step 5  
Click the *set current* button

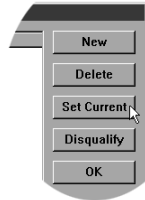

Step 6  
Click OK.

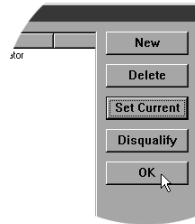

OR

Step 1  
Place the cursor over the status bar as shown.



Step 2  
Click until the desired probe appears in the status bar.



**To add probe tips**

Step 1

Click the *probe library* button on the probe toolbar.



Step 2

Highlight the desired group.

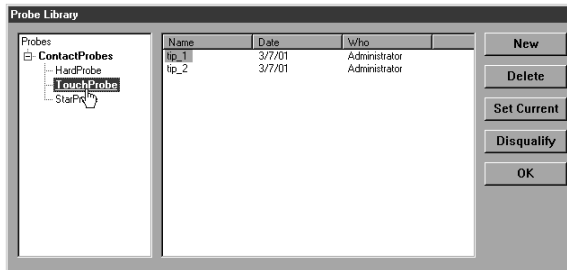

Step 3

Click the *new* button.

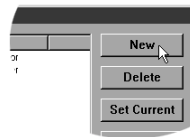

Step 4

Type a name for the probe tip in the *name* text box.

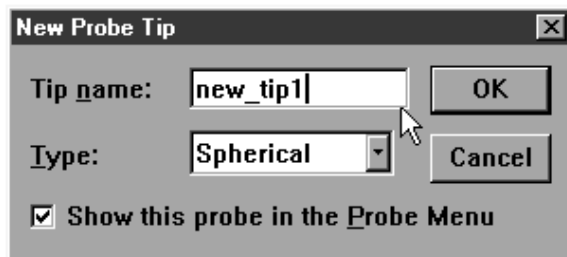

Step 5

Select the appropriate probe type from the pull down list.

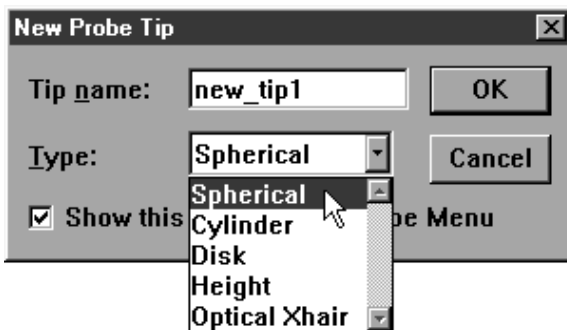

## Chapter 3 Using Probes

---

Step 7

Check the *show this probe in the probe menu* box.

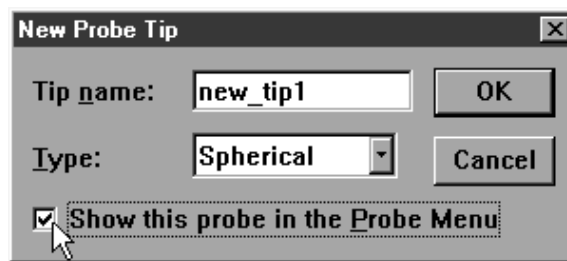

Step 8

Click OK.

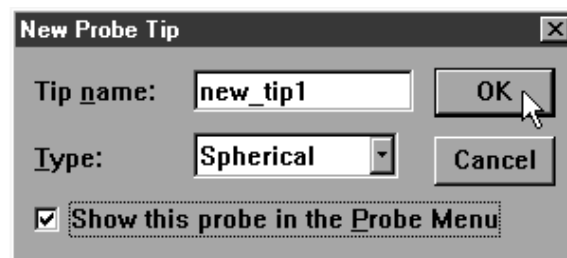



**To delete probe tips**

Step 1

Click the *probe library* button on the probe toolbar.



Step 2

Click on the plus sign next to the desired group in the left-hand box.

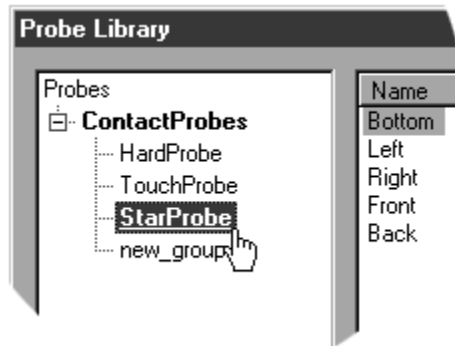

Step 3

Highlight the probe tip to be deleted.

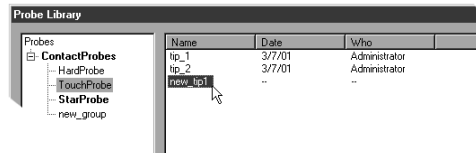

Step 4

Click on the *delete* button.

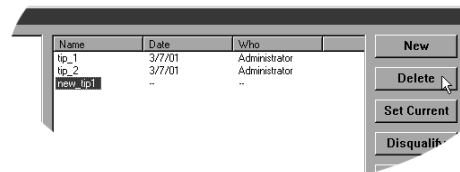

Step 5

Click *yes* in the dialog box.

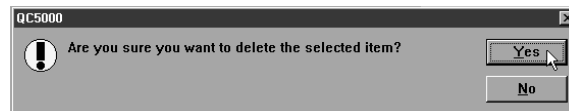

**NOTE**

The QC5000 does not permit the probe in current use to be deleted. The current can be deleted only after a new probe tip is assigned as current.

## Chapter 3 Using Probes

### Probe Results Window

The results window displays the following information for probe qualification

- X,Y,Z offsets (measured from the center of the probe)
- probe diameter
- form (a numerical representation of the deviance from the nominal form)
- qualification sphere diameter

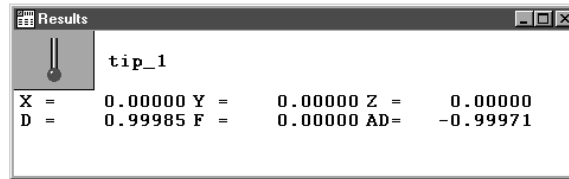

#### NOTE

The qualification results window is a view only window. No information can be dragged into other windows from the qualification results window.

#### NOTE

If the F (form) value shown in the *probe results* window is large re-teach the probe. In general, an *F value* larger than the resolution of the encoders is considered large. For example, an *F value* of 3 microns is large if using 2 micron encoders.





# Chapter 4

## General Measuring

---

### Getting Started

#### Set machine zero

Machine zero is the location where all three axes of the coordinate measuring machine (CMM) read zero. This is an arbitrary point usually selected because it is at the end of negative travel for each axis. Since the machine zero position can vary from machine to machine, consult the distributor or manufacturer information for the specific procedure.

#### To set machine zero

##### Step 1

Double-click the QC5000 icon on the Windows NT desktop.



##### Step 2

Move the axes of the CMM to the machine zero position (consult the CMM user guide for more information) when the dialog box appears on the screen.

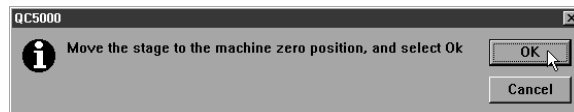

##### Step 3

Click OK in the dialog box.

 NOTE

Use the following procedure if the QC5000 software is already running and machine zero is not set.

Step 1

Select options, then general options, from the tools menu.



Step 2

Select the general tab in the general options window.

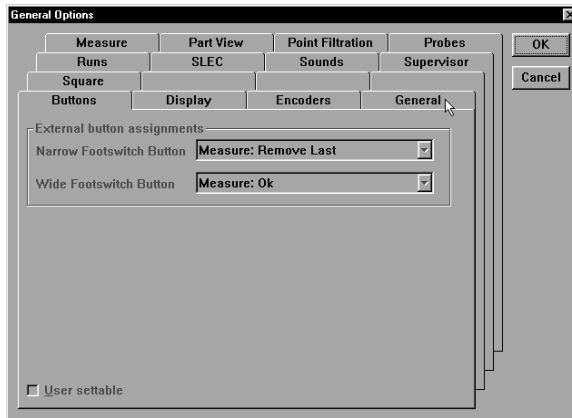

 NOTE

If the general tab is greyed out, enter the supervisor password on the supervisor tab.

Step 3  
Select hard stop in the machine zero box.

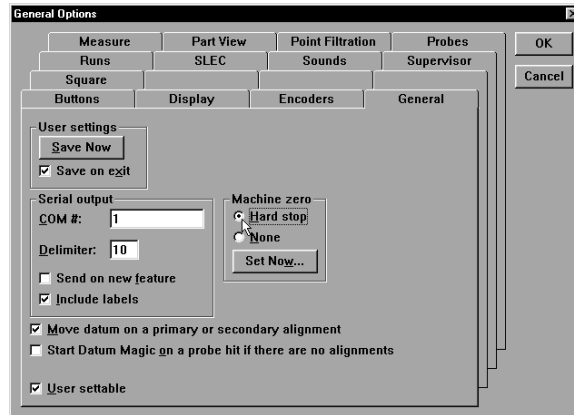

Step 4  
Click the set now button.

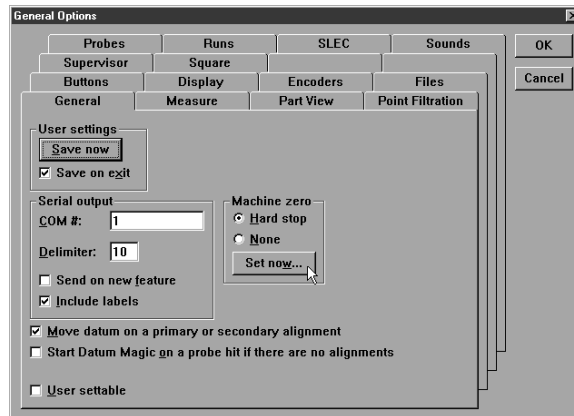

Step 5  
Move the axes of the CMM to the machine zero position (consult the CMM user guide for more information) when the dialog box appears on the screen.

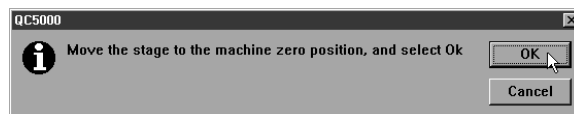

Step 6  
Click OK in the dialog box.

## Chapter 4 General Measuring

Step 7

Click OK in the general options window.

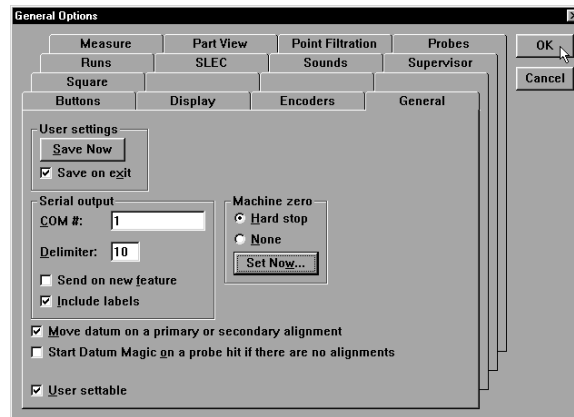

### CAUTION

Set machine zero every time you begin a QC5000 session. Machine zero is used by QC5000 for SLEC (segmented linear error correction) functions. If machine zero is not set, SLEC functions will not work properly.



**Reference Frame**

Parts are made up of features. Features are made up of points. Points are locations within the measuring envelope of the CMM. The measuring envelope is the area of the CMM that can be reached by the probe.

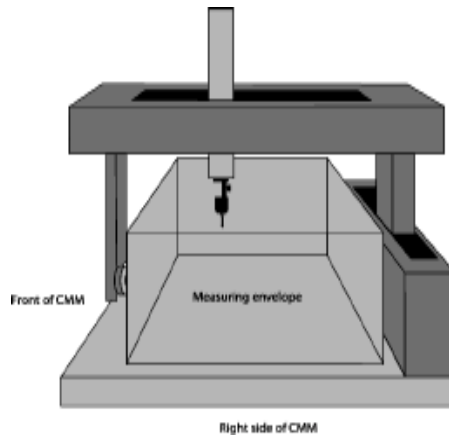

The machine coordinate system defines all the points in the measuring envelope starting a machine zero. Machine zero is the beginning of positive travel on each axis.

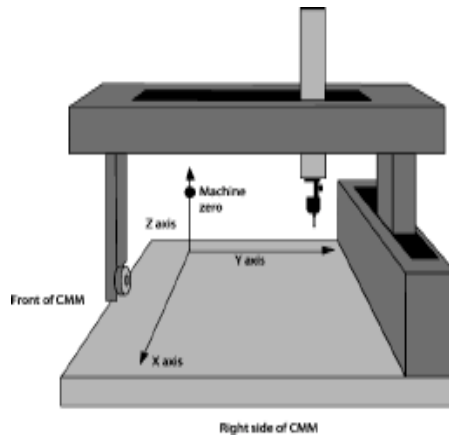

## Chapter 4 General Measuring

### Projection planes

A projection plane is the lateral extension of one axis along another axis in the machine coordinate system.

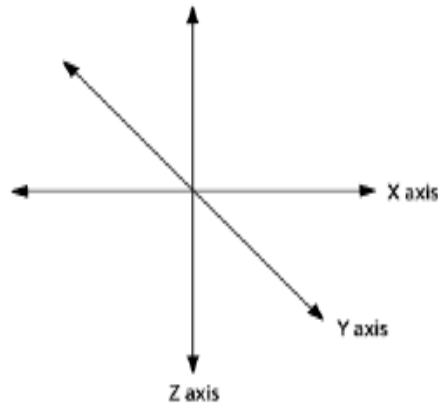

For example, the XY plane is the lateral extension of the X axis along the Y axis.

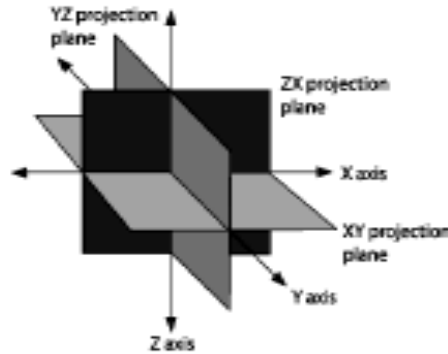

### Machine coordinates

Machine coordinates describe the distance of points within the measuring envelope from machine zero. Until a reference frame is created the QC5000 displays machine coordinates in the DRO window. Once a reference frame is established the DRO display part coordinates.

### Part coordinates

Part coordinates describe the distance of points from the datum, or zero point, of the reference frame. Reference frames are created by probing a primary plane, a secondary line, and a zero point.



**Set machine zero before establishing a reference frame and be sure the current probe is qualified.**

**To create a reference frame**

Step 1

Click the primary plane button on the datum toolbar.

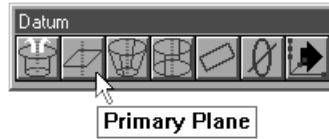

Step 2

Measure three points on the plane as shown.

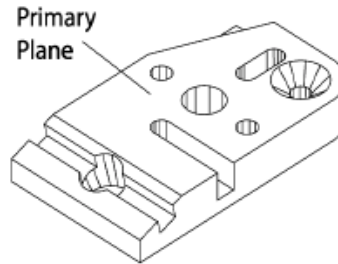

Step 3

Click OK in the dialog box.

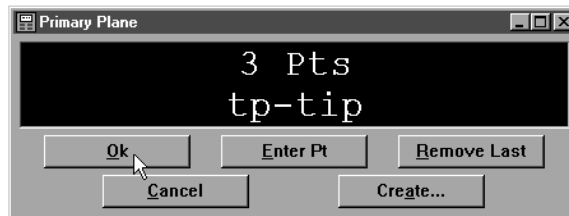

Step 4

Click the secondary line button on the datum toolbar.

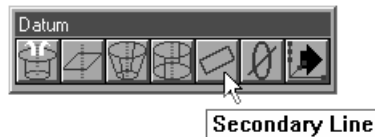

Step 5

Probe two points on the secondary line. Space the points close to the opposite ends of the line.

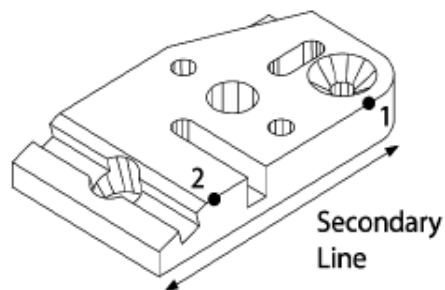

## Chapter 4 General Measuring

Step 6  
Click OK in the dialog box.

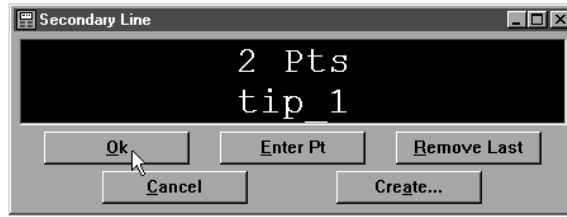

Step 7  
Click the line button on the measure toolbar.

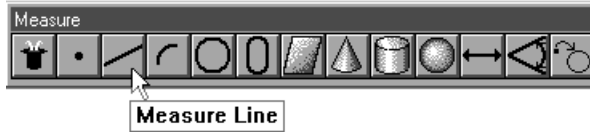

Step 8  
Probe two points along the tertiary alignment as shown.

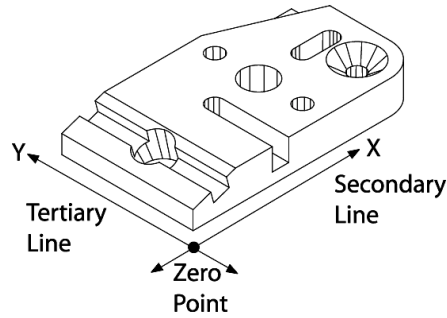

Step 9  
Click OK in the dialog box.

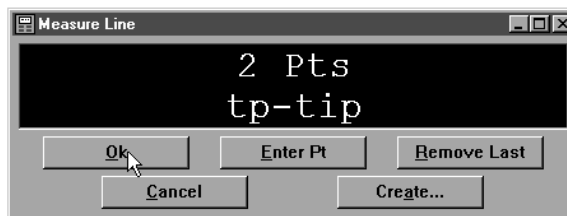

Step 10  
Click the zero point button on the datum toolbar.

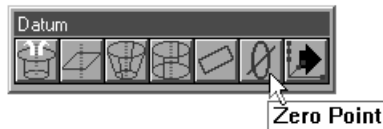

Step 11

Use the mouse to highlight the secondary and tertiary lines in the features list.

I	T	Name	Datum	X	Y	Z	d	r
○		Circle 8		-76.11695	-12.66581	0.00000	10.16752	5.08376
✓		Line 6		0.04394	-37.55966	0.00000		
•		Point 7	Zero	0.00000	0.00000	0.00000		
■		Plane 4	Primary	-81.41003	-38.34949	0.00000		
✓		Line 5	Skew	-56.13519	0.00000	0.00000		

Step 12

Click OK in the dialog box.

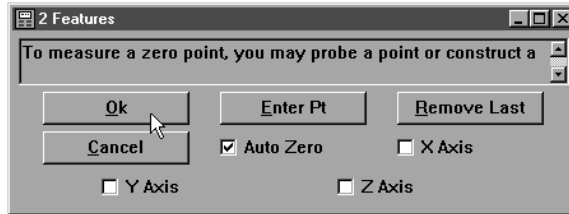

## Chapter 4 General Measuring

### Measuring 2D Features

#### To probe a point



Step 1

Click the point button on the measure toolbar.

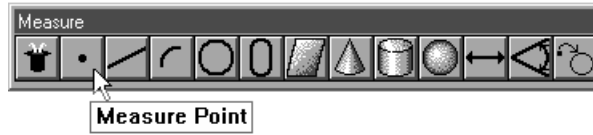

Step 2

Probe the point as shown.

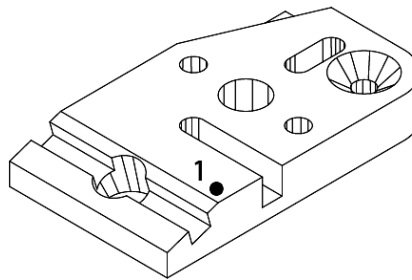

Step 3

Click OK in the dialog box.

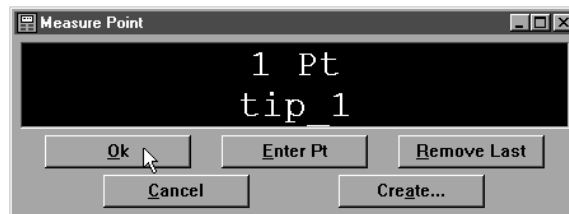

**To probe a line (2 points)**



Step 1  
Click the line button on the measure toolbar.

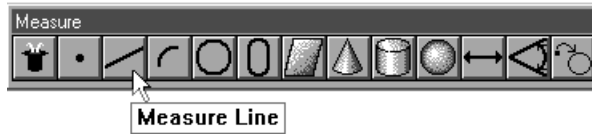

Step 2  
Probe two points on the line as shown. Space the points close to the opposite ends of the line.

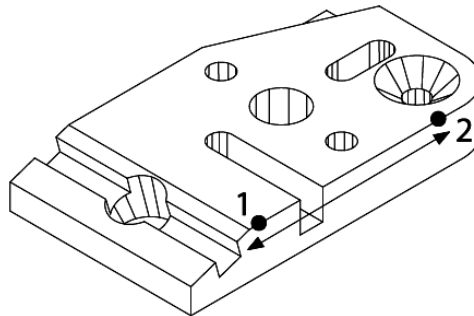

Step 3  
Click OK in the dialog box.



## Chapter 4 General Measuring

### To probe an arc (3 points)



Step 1

Click the arc button on the measure toolbar.



Step 2

Probe three points on the arc in the order shown.

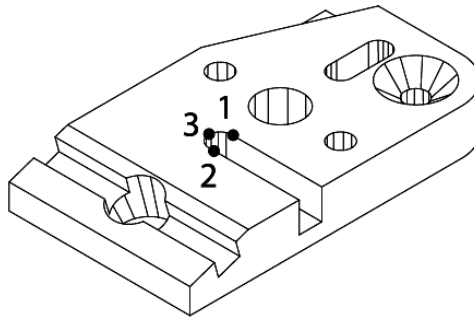

Step 3

Click OK in the dialog box.

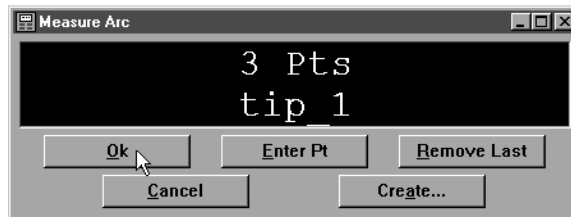



**To probe a circle (3 points)**



Step 1

Click the circle button on the measure toolbar.

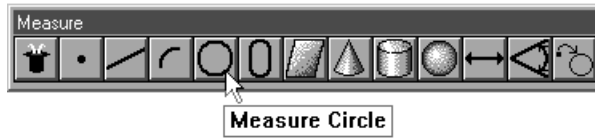

Step 2

Probe a point on the edge of the circle

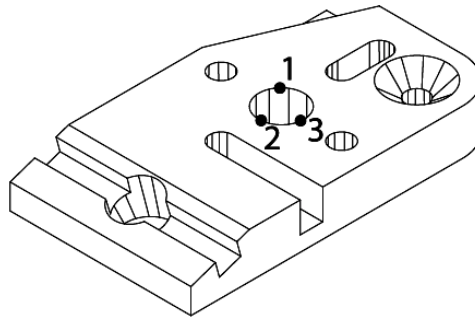

Step 3

Probe the second point approximately 120 degrees from the first point.

Step 4

Probe the third point approximately 120 degrees from the second point.

Step 5

Click OK in the dialog box.

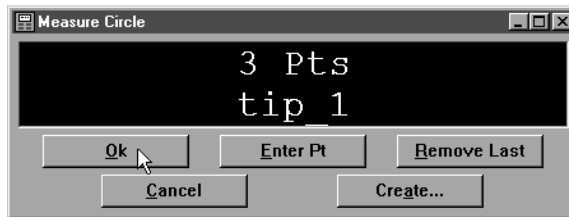

## Chapter 4 General Measuring

### To probe a slot (5 points)



Step 1  
Click the slot button on the measure toolbar.

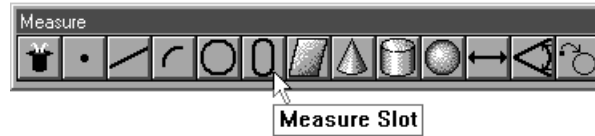

Step 2  
Probe the first two points as shown.

Step 3  
Probe a point, as near the center as possible, on the first arc.

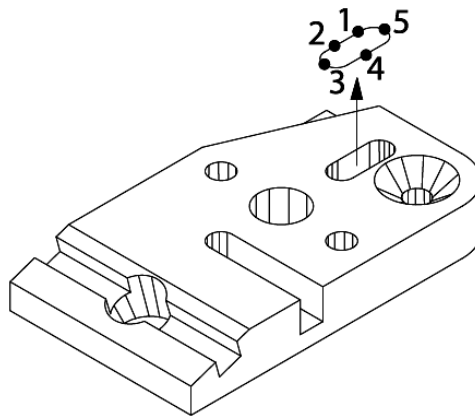

Step 4  
Probe a point near the middle of the second side of the slot.

Step 5  
Probe a point, as near the center as possible, on the second arc.

Step 6  
Click OK in the dialog box.



**To probe a plane (3 points)**



Step 1

Click the plane button on the measure toolbar.

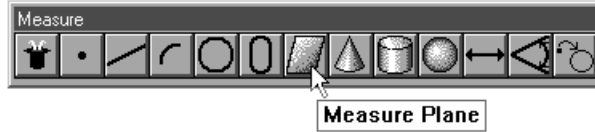

Step 2

Measure three points on the plane as shown.

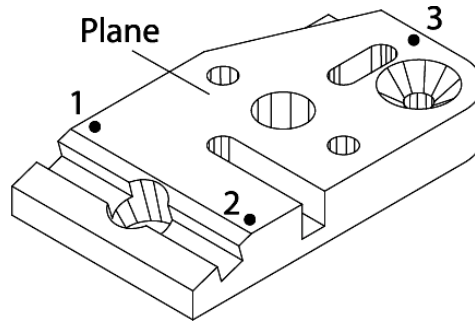

Step 3

Click OK in the dialog box.

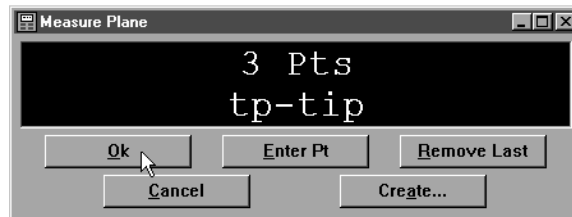

## Chapter 4 General Measuring

### Measuring 3D Features

#### To probe a cone (3 points)



##### Step 1

Click the cone button on the measure toolbar.

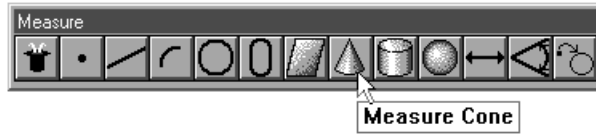

##### Step 2

Probe three points around the top of the cone spacing the points evenly as shown.

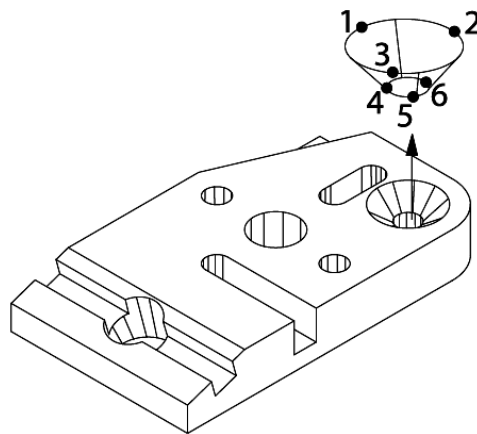

##### Step 3

Probe three points around the bottom of the cone spacing the points evenly as shown.

##### Step 4

Click OK in the dialog box.

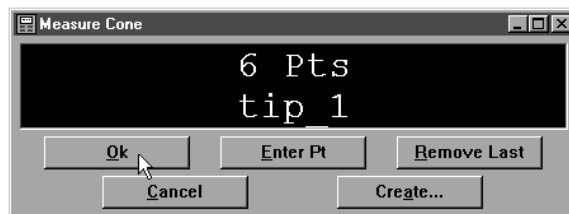

**To probe a cylinder (6 points)**



**Step 1**

Click the cylinder button on the measure toolbar.



**Step 2**

Probe 3 points around the top of the cylinder spacing the points evenly as shown.

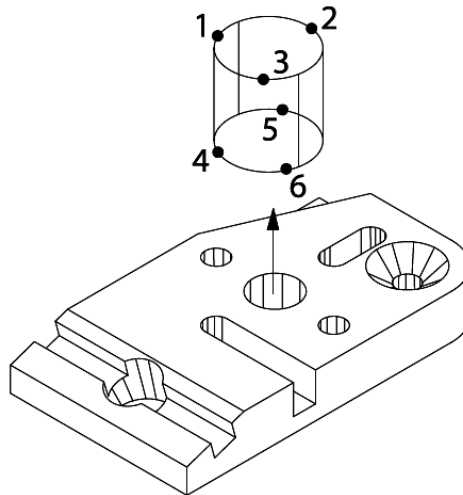

**Step 3**

Probe 3 points around the bottom of the cylinder spacing the points evenly as shown.

**Step 4**

Click OK in the dialog box.

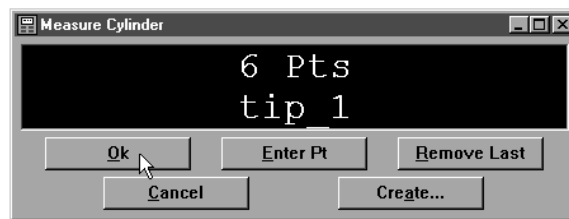

## Chapter 4 General Measuring

### To probe a sphere (5 points)



Step 1

Click the sphere button on the measure toolbar.



Step 2

Probe a point on the top of the sphere as shown.

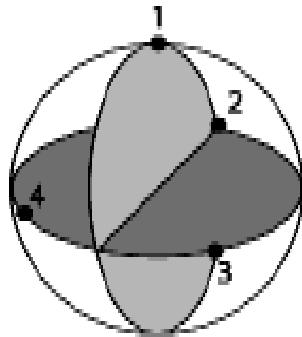

Step 3

Probe 3 points around the equator of the sphere as shown.

Step 4

Click OK in the dialog box.

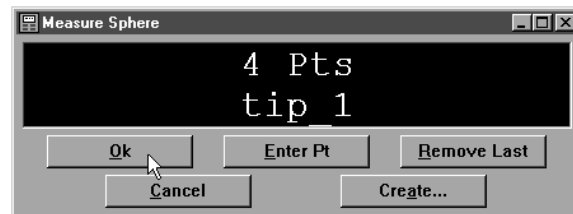

## Constructing Features

It is sometimes useful to construct a new feature from existing features. This section demonstrates all feature constructions.

### Point Constructions

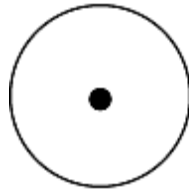

**Center Point**

#### To construct a center point

##### Step 1

Use the mouse to highlight a slot, circle, or other positional feature on the features list.

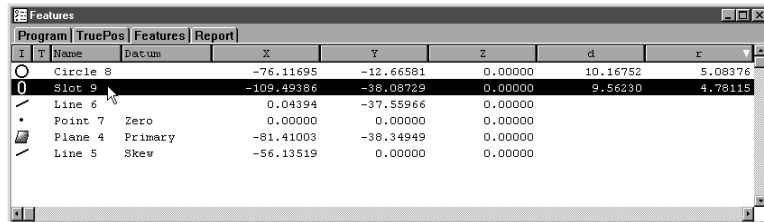

##### Step 2

Click point button on the measure toolbar.



##### Step 3

Click OK in the dialog box.

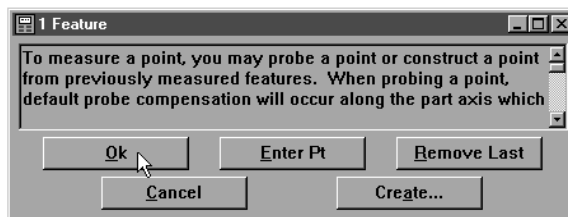



## Apex Point

### To construct an apex point

#### Step 1

Use the mouse to highlight a cone or an angle on the features list.

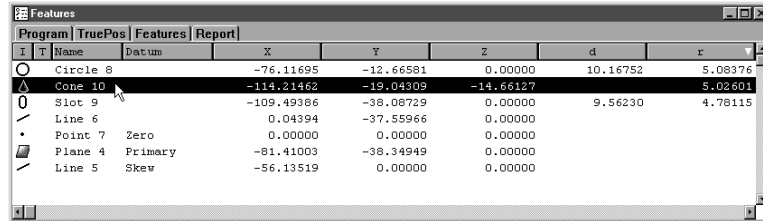

#### Step 2

Click the point button on the measure toolbar.



#### Step 3

Click OK in the dialog box.

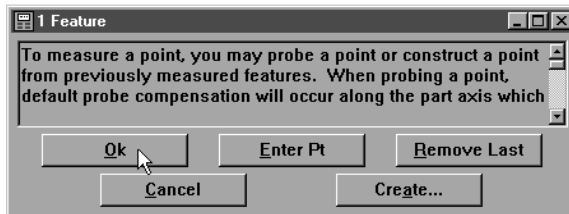



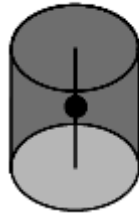

## Application Point

Midpoint of a linear feature or plane

### To construct an application point

#### Step 1

Use the mouse to highlight a linear feature or plane on the features list.

Program	TruePos	Features	Report						
I	T	Name	Datum	X	Y	Z	d	r	
○		Cylinder		-76.03881	-38.02763	-8.08435	18.96087	9.48043	
○		Circle 8		-76.11695	-12.66581	0.00000	10.16752	5.08376	
△		Cone 10		-114.21462	-19.04309	-14.66127		5.02601	
0		Slot 9		-109.49386	-38.08729	0.00000	9.56230	4.78115	
/		Line 6		0.04394	-37.55966	0.00000			
•		Point 7	Zero	0.00000	0.00000	0.00000			
		Plane 4	Primary	-81.41003	-38.34949	0.00000			
/		Line 5	Skew	-56.13519	0.00000	0.00000			

#### Step 2

Click the point button on the measure toolbar.



#### Step 3

Click OK in the dialog box.

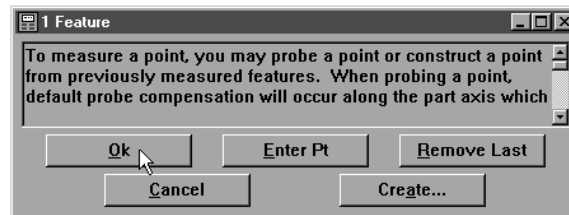

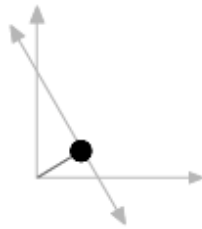

## Anchor Point

### To construct an anchor point

#### Step 1

Use the mouse to highlight a linear feature on the features list.

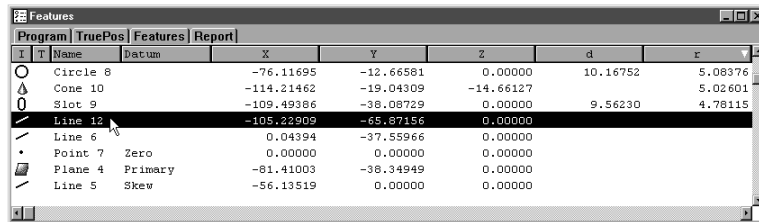

#### Step 2

Click the point button on the measure toolbar.



#### Step 3

Click OK in the dialog box.

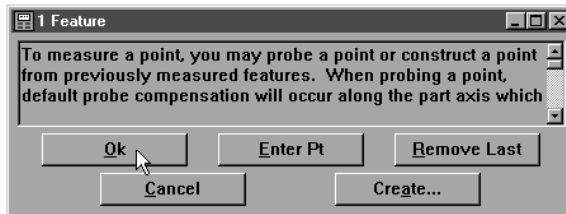

#### Step 4

Right click in the results window and select anchor point from the list.

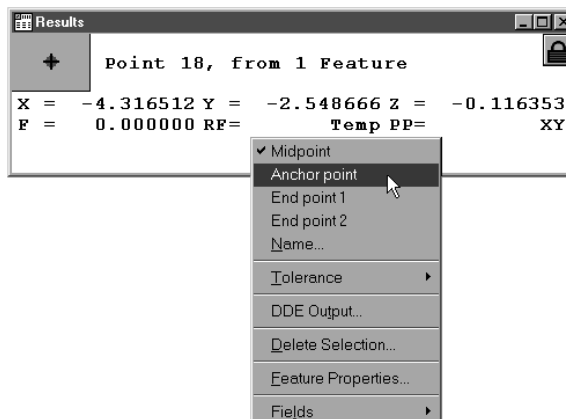

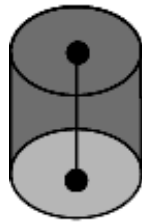

## Bounding Points

### To construct bounding points

#### Step 1

Use the mouse to highlight a linear feature on the features list.

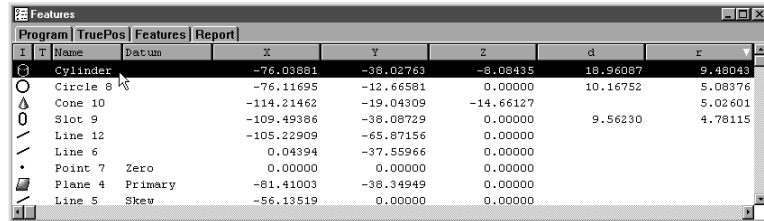

#### Step 2

Click the point button on the measure toolbar.



#### Step 3

Click OK in the dialog box.

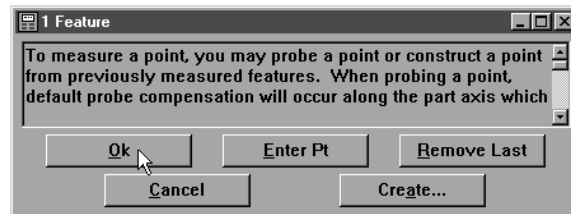

#### Step 4

Right click in the results window and select endpoint 1 (top) or endpoint 2 (bottom) from the list.

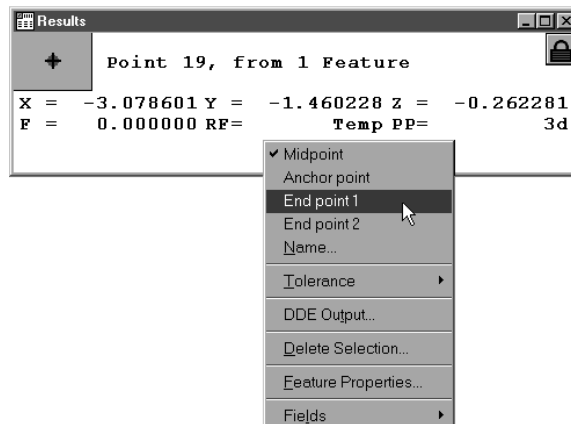

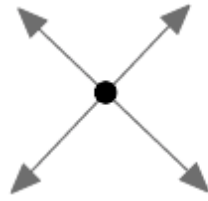

### Intersection of 2 Lines

To construct a point from 2 intersecting lines

Step 1

Use the mouse to highlight two intersecting lines on the features list.

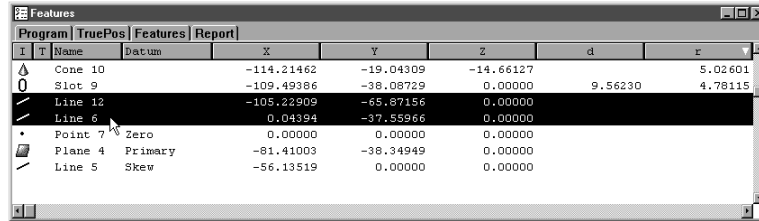

Step 2

Click the point button on the measure toolbar.



Step 3

Click OK in the dialog box.

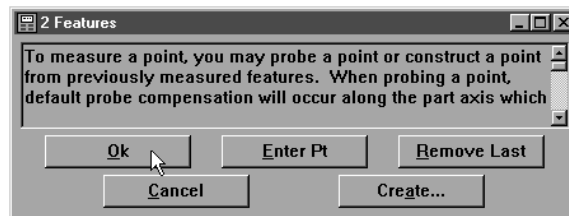

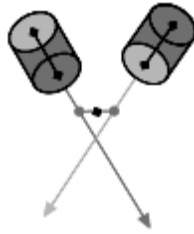

## Closest Point of Approach

To construct a closest point of approach point

Step 1

Use the mouse to highlight two linear features on the features list.

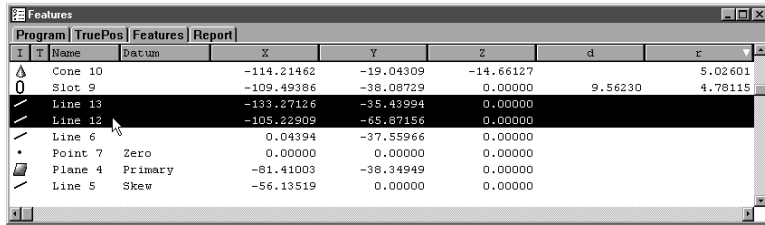

Step 2

Click the point button on the measure toolbar.



Step 3

Click OK in the dialog box.

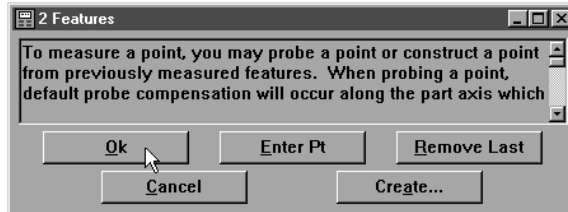

Step 4

Right click in the results window and select closest point of approach from the list.

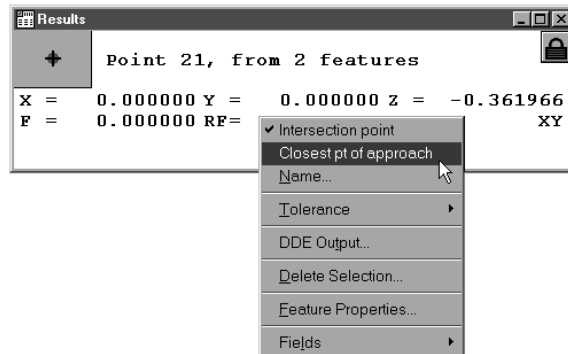

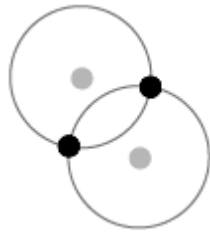

## Intersection of 2 Circles

### To construct points from intersecting circles

Step 1

Use the mouse to highlight two overlapping circles on the features list.

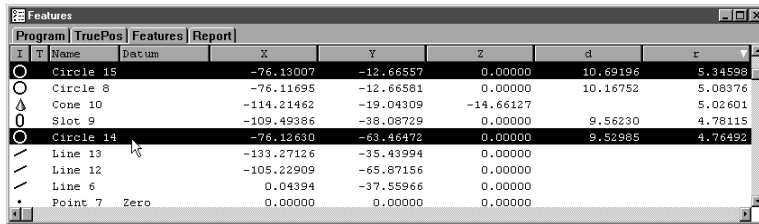

Step 2

Click the point button on the measure toolbar.



Step 3

Click OK in the dialog box.

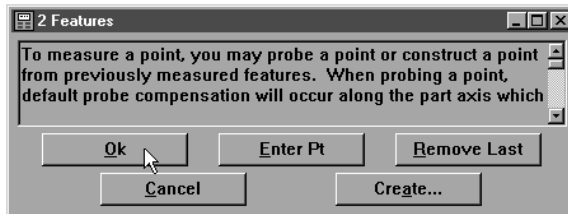

Step 4

Right click in the results window and select intersect point 1 or intersect point 2 from the list.

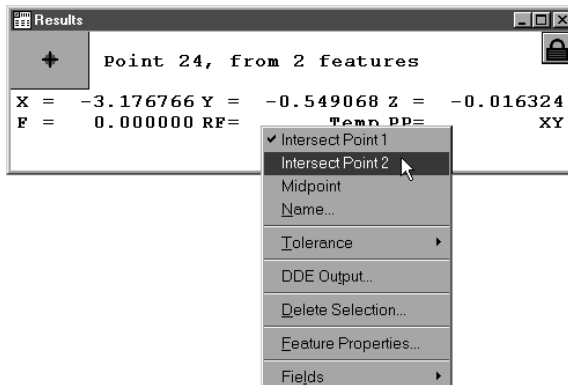

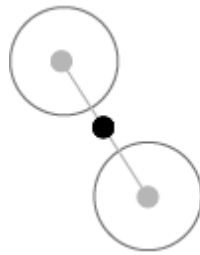

## Midpoint of 2 Circles

### To construct a midpoint from two circles

#### Step 1

Use the mouse to highlight two circles on the features list.

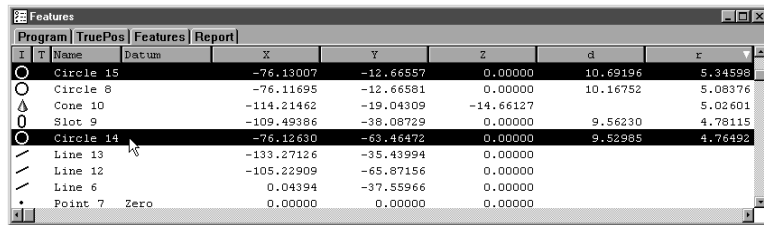

#### Step 2

Click the point button on the measure toolbar.



#### Step 3

Click OK in the dialog box.

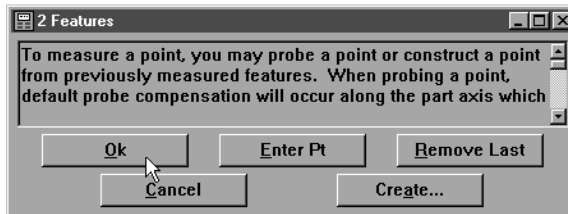

#### Step 4

Right click in the results window and select midpoint from the list.

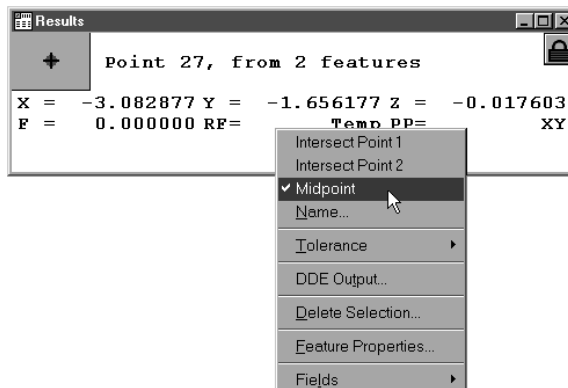

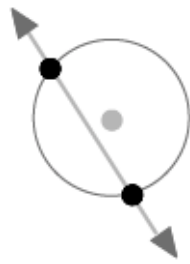

## Intersection of a Line and a Circle

To construct a point from the intersection of a line and a circle

Step 1

Use the mouse to highlight a circle and an intersecting line on the features list.

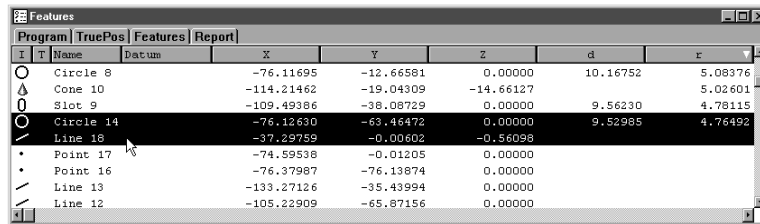

Step 2

Click the point button on the measure toolbar.



Step 3

Click OK in the dialog box.

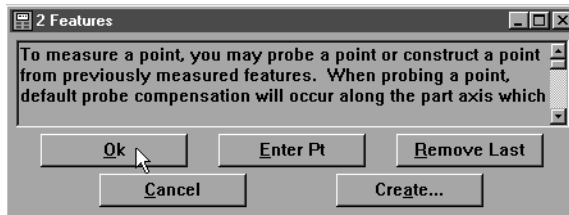

Step 4

Right click in the results window and select intersect point 1 or intersect point 2 from the list.

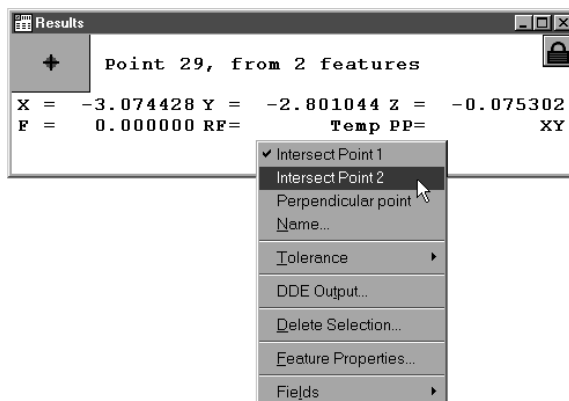



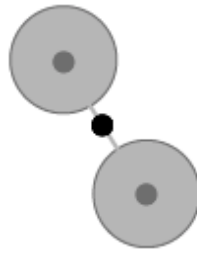

## Midpoint of 2 Positional Features

### To construct a midpoint from 2 positional features

#### Step 1

Use the mouse to highlight two positional (circles, spheres, cylinders, etc.) features on the features list.

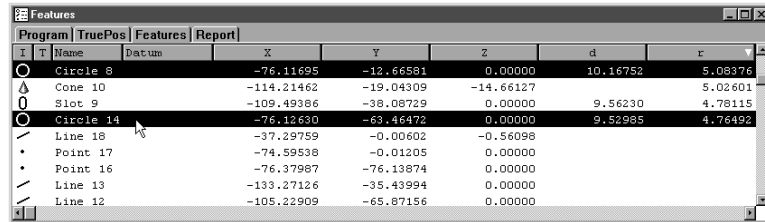

#### Step 2

Click the point button on the measure toolbar.



#### Step 3

Click OK in the dialog box.

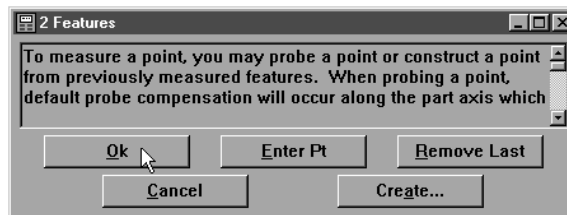

#### Step 4

Right click in the results window and select midpoint from the list.

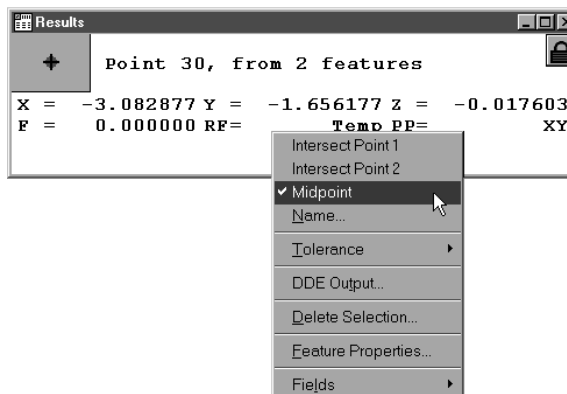

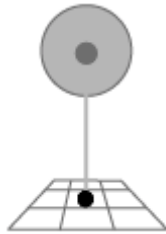

## Perpendicular Point Constructed from a Plane and a Positional Feature

To construct a perpendicular point from a positional feature and a plane

Step 1

Use the mouse to highlight a plane and a positional feature on the features list.

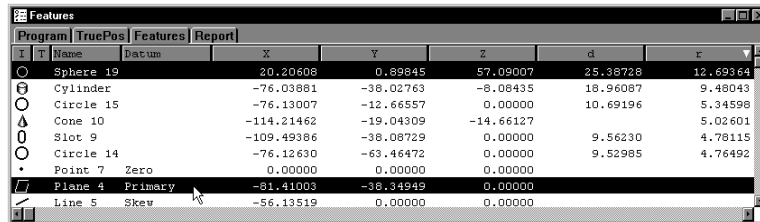

Step 2

Click the point button on the measure toolbar.



Step 3

Click OK in the dialog box.

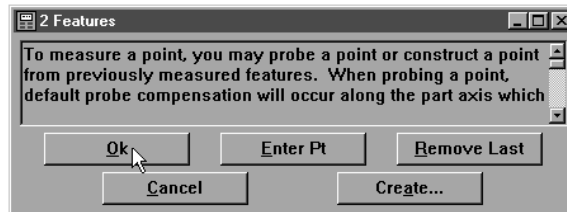

To construct a point from a linear feature and a plane

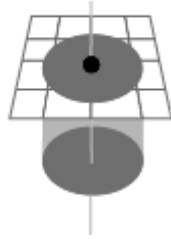

**Intersection of a Plane and Line**

Step 1

Use the mouse to highlight a linear feature and a plane on the features list.

Program		TruePos	Features	Report							
I	T	Name	Datum		X	Y	Z	d	r		
○		Sphere 19			20.20608	0.89845	57.09007	25.38728	12.69364		
○		Cylinder			-76.03881	-38.02763	-8.08435	18.96087	9.48043		
○		Circle 15			-76.13007	-12.66557	0.00000	10.69196	5.34598		
△		Cone 10			-114.21462	-19.04309	-14.66127		5.02601		
○		Slot 9			-109.49386	-38.08729	0.00000	9.56230	4.78115		
○		Circle 14			-76.12630	-63.46472	0.00000	9.52985	4.76492		
•		Point 7	Zero		0.00000	0.00000	0.00000				
□		Plane 4	Primary		-81.41003	-38.34949	0.00000				
□		Line 5	Skew		-56.13519	0.00000	0.00000				

Step 2

Click the point button on the measure toolbar.



Step 3

Click OK in the dialog box.

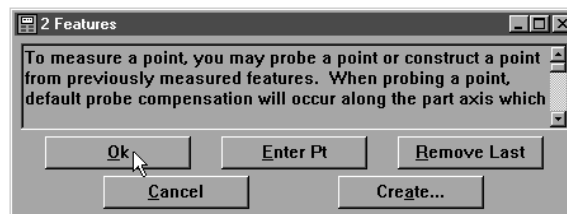

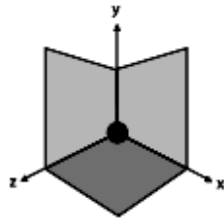

### Intersection of 3 Planes

To construct a point from the intersection of 3 planes

Step 1

Use the mouse to highlight 3 planes on the features list.

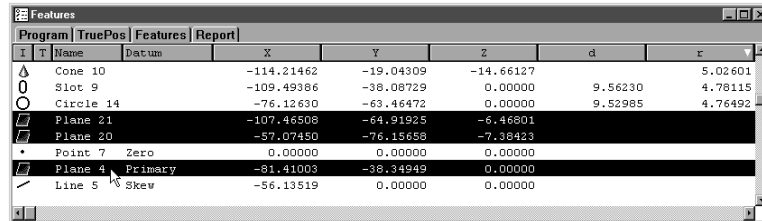

Step 2

Click the point button on the measure toolbar.



Step 3

Click OK in the dialog box.

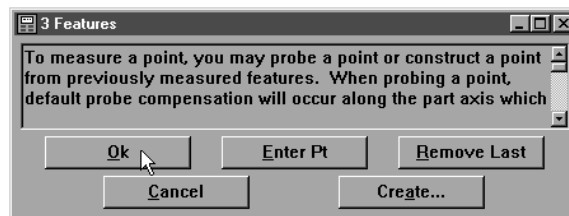

## Line Constructions



**Axis Line**

### To construct an axis line from a linear feature

#### Step 1

Use the mouse to highlight a linear feature in the features list.

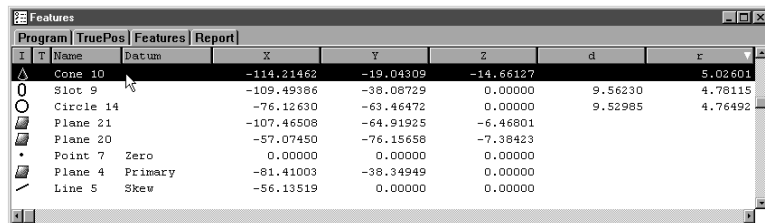

#### Step 2

Click the line button on the measure toolbar.

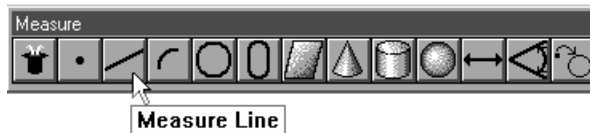

#### Step 3

Click OK in the dialog box.

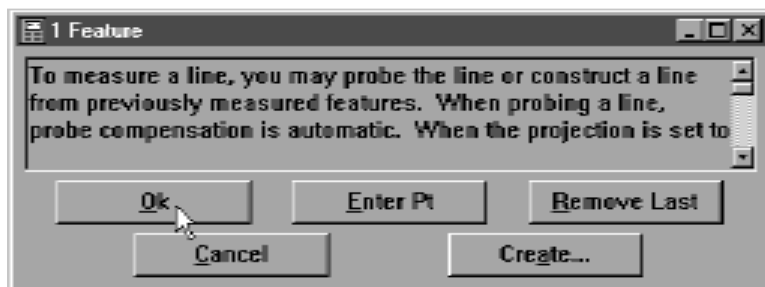

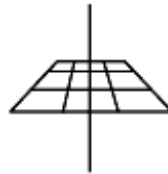

### Plane Axis (Normal Line)

#### To construct a plane axis line (Normal Line)

Step 1

Use the mouse to highlight a plane on the features list.

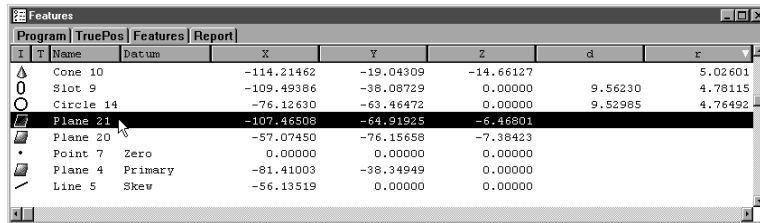

Step 2

Click the line button in the measure toolbar.



Step 3

Click OK in the dialog box.

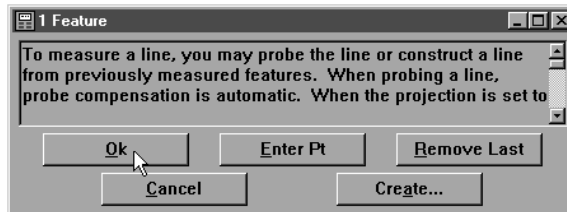



## Slot Lines

To construct a midline from the sides of a slot

Step 1

Use the mouse to highlight a slot on the features list.

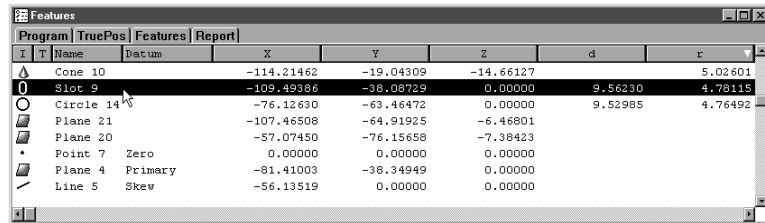

Step 2

Click the line button in the measure toolbar.

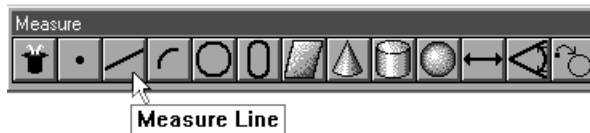

Step 3

Click OK in the dialog box.

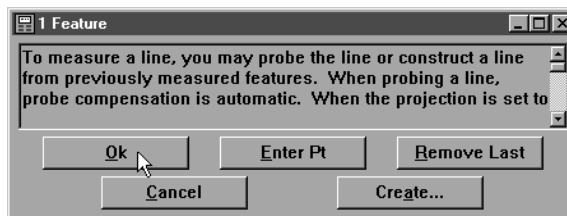



### Two Point Line Constructed from 2 Positional Features

To construct a 2 point line from two positional features

Step 1

Use the mouse to highlight two positional features on the features list.

I	T	Name	Datum	X	Y	Z	d	r
○		Circle 15		-76.13007	-12.66557	0.00000	10.69196	5.34598
▲		Cone 10		-114.21462	-19.04309	-14.66127		5.02601
○		Slot 9		-109.49386	-38.08729	0.00000	9.56230	4.78115
○		Circle 14		-76.12630	-63.46472	0.00000	9.52985	4.76492
□		Plane 21		-107.46508	-64.91925	-6.46801		
□		Plane 20		-57.07450	-76.15658	-7.38423		
•		Point 7	Zero	0.00000	0.00000	0.00000		
□		Plane 4	Primary	-81.41003	-38.34949	0.00000		
□		Line 5	Skew	-56.13519	0.00000	0.00000		

Step 2

Click the line button on the measure toolbar.



Step 3

Click OK in the dialog box.

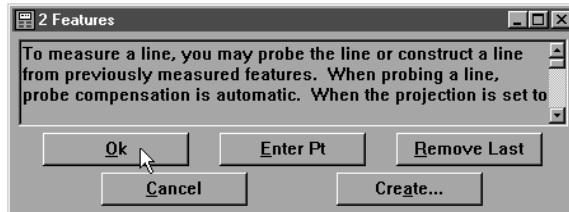



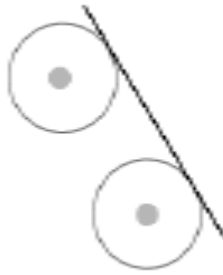

## Tangent Line Constructed from 2 Radial Positional Features

To construct a tangent line from 2 radial positional features

Step 1

Use the mouse to highlight two radial positional features on the features list.

Features									
Program   TruePos   Features   Report									
I	T	Name	Datum	X	Y	Z	d	r	
		Circle 15		-76.13007	-12.66557	0.00000	10.69196	5.34598	
		Cone 10		-114.21462	-19.04309	-14.66127		5.02601	
		Slot 9		-109.49386	-38.08729	0.00000	9.56230	4.78115	
		Circle 14		-76.12630	-63.46472	0.00000	9.52985	4.76492	
		Plane 21		-107.46508	-64.91925	-6.46801			
		Plane 20		-57.07450	-76.15658	-7.38423			
		Point 7	Zero	0.00000	0.00000	0.00000			
		Plane 4	Primary	-81.41003	-38.34949	0.00000			
		Line 5	Skew	-56.13519	0.00000	0.00000			

Step 2

Click the line button on the measure toolbar.

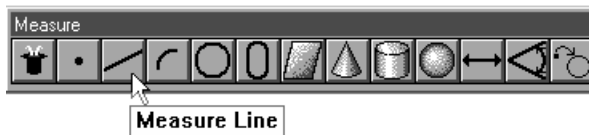

Step 3

Click OK in the dialog box.

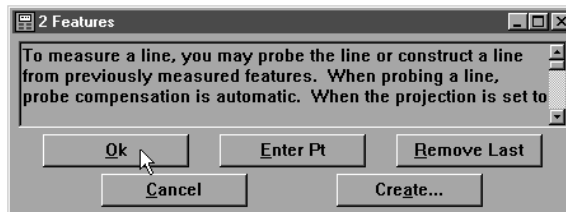

## Chapter 4 General Measuring

Step 4

Right click in the results window and select tangent 1 or tangent 2 from the list.

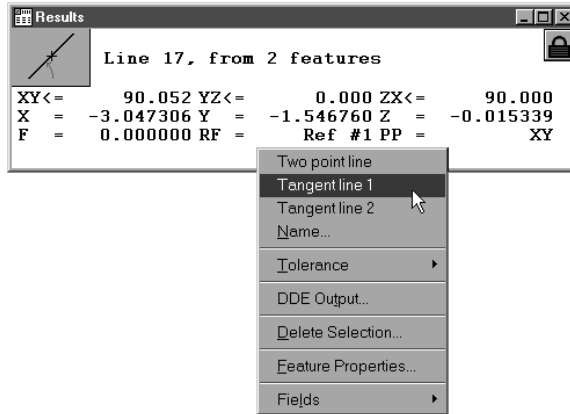

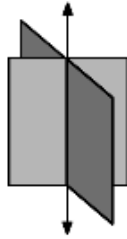

## Intersection of 2 Planes

### To construct a line from the intersection of 2 planes

#### Step 1

Use the mouse to highlight two planes on the features list.

Features							
		Program	TruePos	Features	Report		
I	T	Name	Datum	X	Y	Z	r
○		Circle 15		-76.13007	-12.66557	0.00000	5.34598
▲		Cone 10		-114.21462	-19.04309	-14.66127	5.02601
○		Slot 9		-109.49386	-38.08729	0.00000	4.78115
○		Circle 14		-76.12630	-63.46472	0.00000	4.76492
□		Plane 21		-107.46508	-64.91925	-6.46801	
□		Plane 20		-57.07450	-76.15658	-7.38423	
•		Point 7	Zero	0.00000	0.00000	0.00000	
□		Plane 4	Primary	-81.41003	-38.34949	0.00000	
□		Line 5	Skew	-56.13519	0.00000	0.00000	

#### Step 2

Click the line button on the measure toolbar.

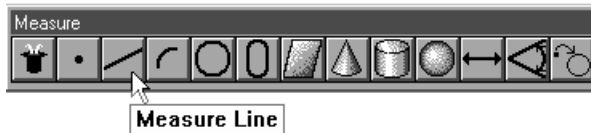

#### Step 3

Click OK in the dialog box.

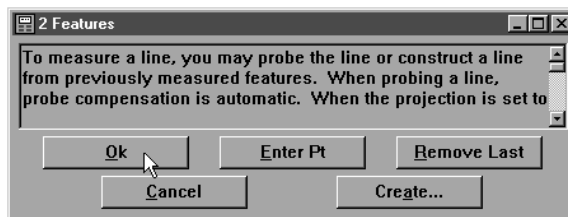

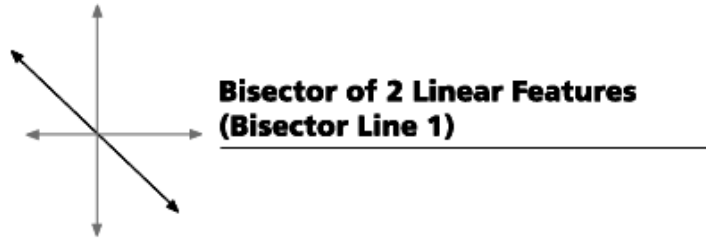

**To construct a bisector of 2 linear features**

Step 1

Use the mouse to highlight two linear features on the features list.

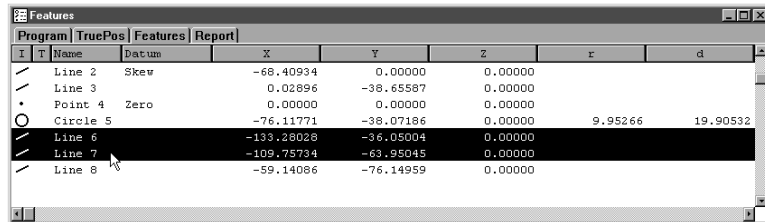

Step 2

Click the line button on the measure toolbar.

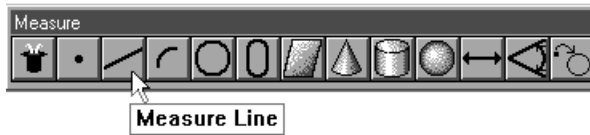

Step 3

Click OK in the dialog box.

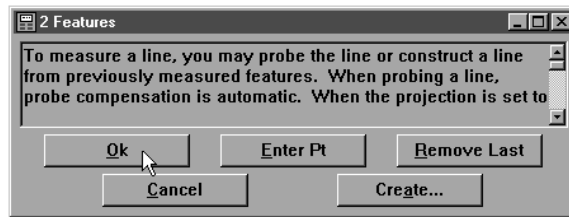

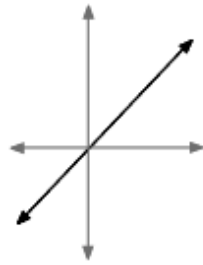

**Bisector of 2 Linear Features  
(Bisector Line 2)**

To construct a perpendicular bisector of 2 linear features

Step 1

Use the mouse to highlight two positional features on the features list.

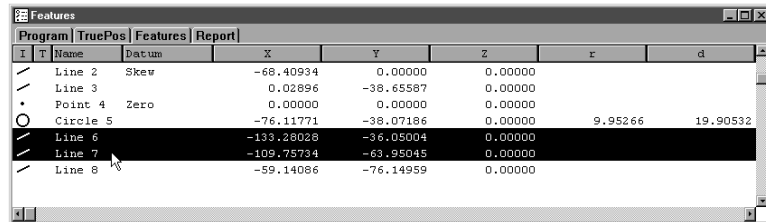

Step 2

Click the line button on the measure toolbar.

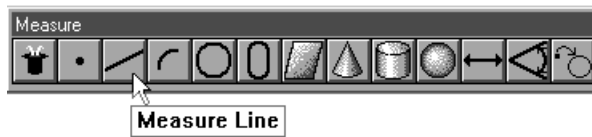

Step 3

Click OK in the dialog box.

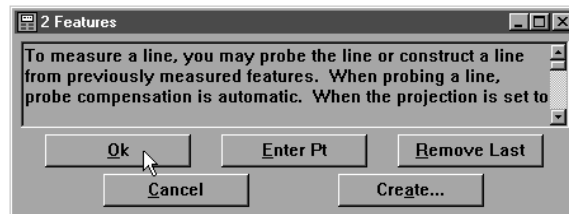

## Chapter 4 General Measuring

---

Step 4

Right click in the results window and select bisector 2 from the list.

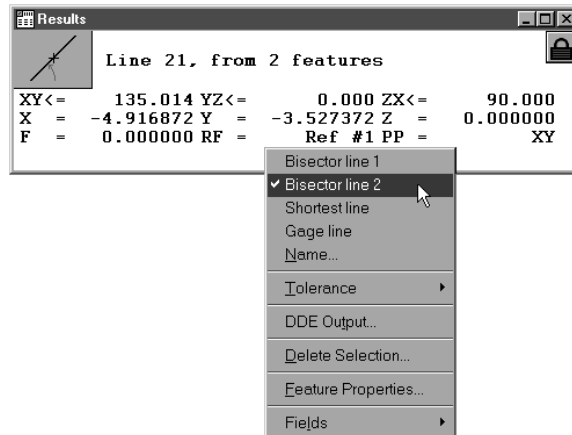

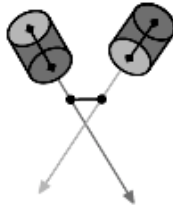

**Line Constructed from the Closest Points of 2 Non-Intersecting Linear Features**

To construct a closest point of approach line from 2 linear features

Step 1

Use the mouse to highlight two linear features on the features list.

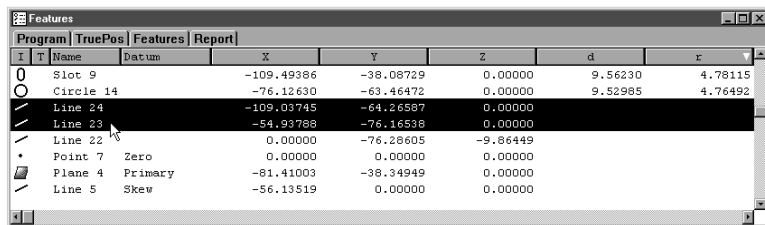

Step 2

Click the line button on the measure toolbar.

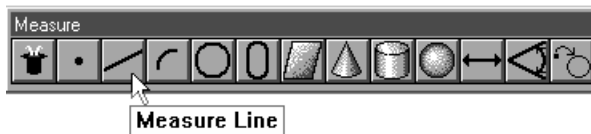

Step 3

Click OK in the dialog box.

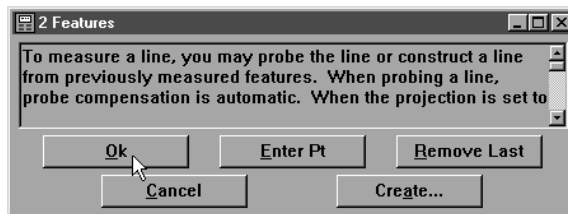

## Chapter 4 General Measuring

Step 4

Right click in the results window and select closest from the list.

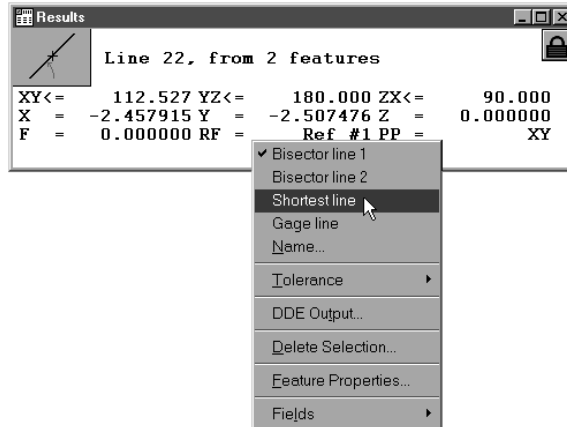



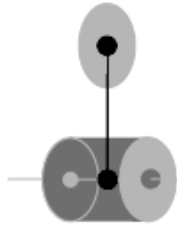

**Perpendicular Line Constructed from a Positional Feature to a Linear Feature**

**To construct a line from a positional feature perpendicular to a linear feature**

Step 1

Use the mouse to highlight a positional feature and a linear feature on the features list.

Features								
		Program	TruePos	Features	Report			
I	T	Name	Datum	X	Y	Z	d	r
○		Sphere 19		20.20608	0.89845	57.09007	25.38728	12.69364
○		Cylinder		-76.03881	-38.02763	-8.08435	18.96087	9.48043
○		Circle 15		-76.13007	-12.66557	0.00000	10.69196	5.34598
△		Cone 10		-114.21462	-19.04309	-14.66127		5.02601
○		Slot 9		-109.49386	-38.08729	0.00000	9.56230	4.78115
○		Circle 14		-76.12630	-63.46472	0.00000	9.52985	4.76492
/		Line 24		-109.03745	-64.26587	0.00000		
/		Line 23		-54.93788	-76.16538	0.00000		
/		Line 22		0.00000	-76.28605	-9.86449		

Step 2

Click the line button on the measure toolbar.

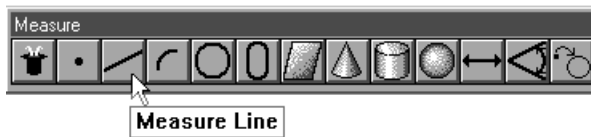

Step 3

Click OK in the dialog box.

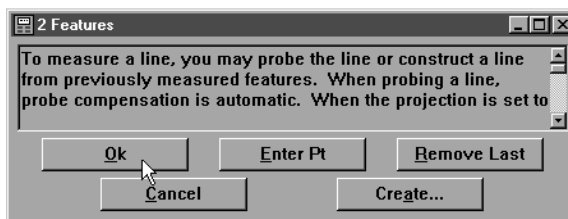



To construct a line parallel to a linear feature using a positional feature

Step 1

Use the mouse to highlight a positional feature and a linear feature on the features list.

Features							
Program		TruePos	Features	Report			
I	T	Name	Datum	X	Y	Z	r
		Sphere 19		20.20608	0.89845	57.09007	12.69364
		Cylinder		-76.03881	-38.02763	-8.08435	9.48043
		Circle 15		-76.13007	-12.66557	0.00000	5.34598
		Cone 10		-114.21462	-19.04309	-14.66127	5.02601
		Slot 9		-109.49386	-38.08729	0.00000	4.78115
		Circle 14		-76.12630	-63.46472	0.00000	4.76492
		Line 24		-109.03745	-64.26587	0.00000	
		Line 23		-54.93788	-76.16538	0.00000	
		Line 22		0.00000	-76.28605	-9.86449	

Step 2

Click the line button on the measure toolbar.

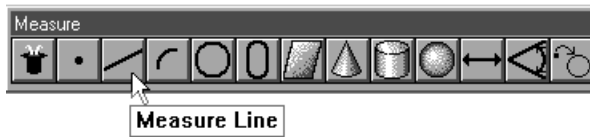

Step 3

Click OK in the dialog box.

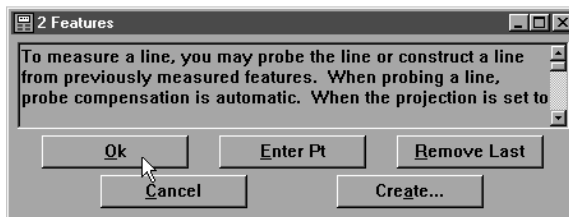

Step 4

Right click in the results window and select parallel from the list.

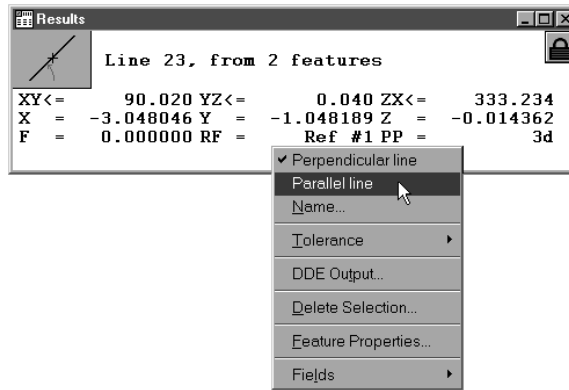

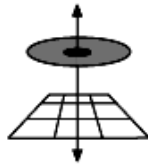

**Perpendicular Line Constructed from a Positional Feature and a Plane**

**To construct a perpendicular line through a plane and a positional feature**

Step 1

Use the mouse to highlight a positional feature and a plane on the features list.

Features								
Program		TruePos	Features	Report				
I	T	Name	Datum	X	Y	Z	d	r
0		Slot 9		-109.49386	-38.08729	0.00000	9.56230	4.78115
		Circle 14		-76.12630	-63.46472	0.00000	9.52985	4.76492
/		Line 24		-109.03745	-64.26587	0.00000		
/		Line 23		-54.93788	-76.16538	0.00000		
/		Line 22		0.00000	-76.28605	-9.86449		
*		Point 7	Zero	0.00000	0.00000	0.00000		
/		Plane 4	Primary	-81.41003	-38.34949	0.00000		
/		Line 5	Skew	-56.13519	0.00000	0.00000		

Step 2

Click the line button on the measure toolbar.

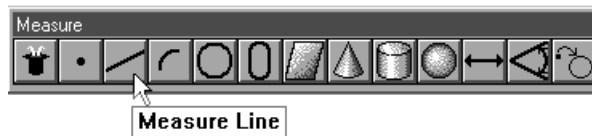

Step 3

Click OK in the dialog box.

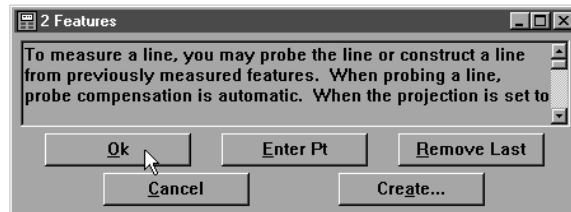

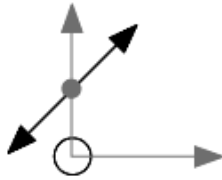

### Line Rotated from Leg of an Angle

To construct a rotated line from the leg of an angle and the angle

Step 1

Use the mouse to highlight an angle and a leg of an angle on the features list.

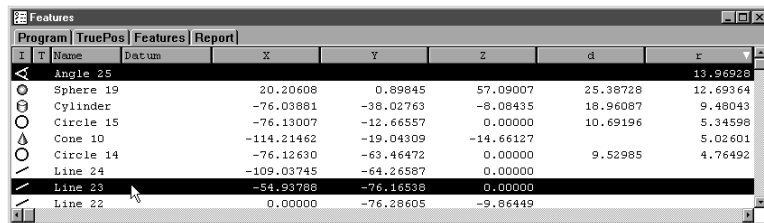

Step 2

Click the line button on the measure toolbar.

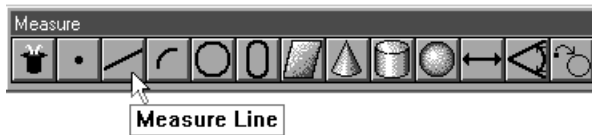

Step 3

Click OK in the dialog box.

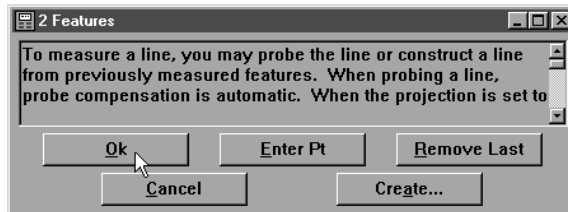

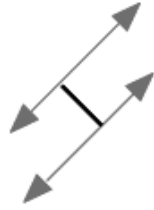

### Gage Line from 2 Lines

#### To construct a gage line

##### Step 1

Use the mouse to highlight 2 lines on the features list.

Program	TruePos	Features	Report					
I	T	Name	Datum	X	Y	Z	d	r
		Cone 10		-114.21462	-19.04309	-14.66127		5.02601
		Circle 14		-76.12630	-63.46472	0.00000	9.52985	4.76492
		Line 27		-55.52301	-19.03383	0.00000		
		Line 26		-45.96094	-19.50256	0.00000		
		Line 22		0.00000	-76.28605	-9.86449		
		Point 7	Zero	0.00000	0.00000	0.00000		
		Plane 4	Primary	-81.41003	-38.34949	0.00000		
		Line 5	Skew	-56.13519	0.00000	0.00000		

##### Step 2

Click the line button on the measure toolbar.

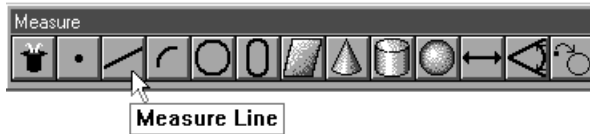

##### Step 3

Click OK in the dialog box.

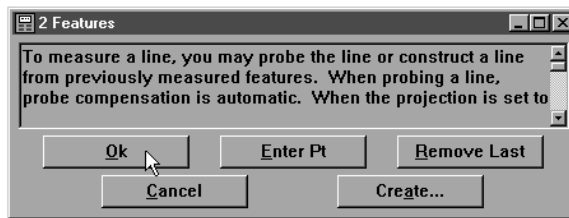

Step 4

Right click in the results window and select gage line from the list.

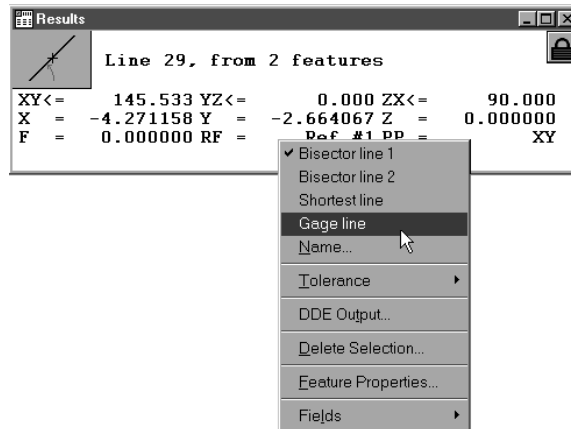

Enter a length in the gage line dialog box and click OK if the lines are not parallel.

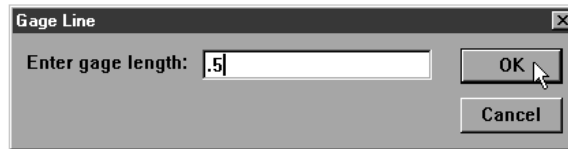

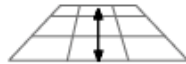

### Projection of a Line to a Plane

To construct a line by projecting an existing line on a new projection plane

Step 1

Use the mouse to highlight a line on the features list.

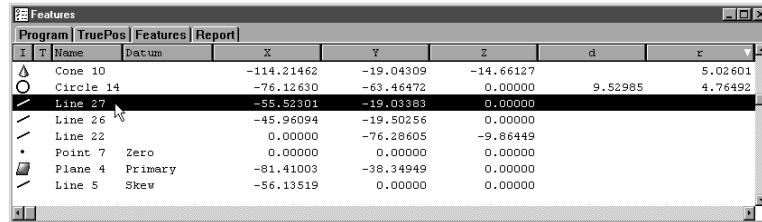

Step 2

Click on the projection box in the status bar until the desired projection (XY, YZ, ZX) plane appears.



Step 3

Click the line button on the measure toolbar.

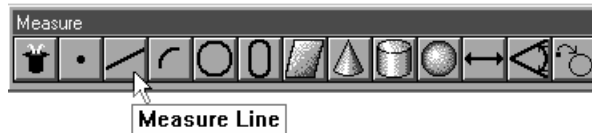

Step 4

Click OK in the dialog box.

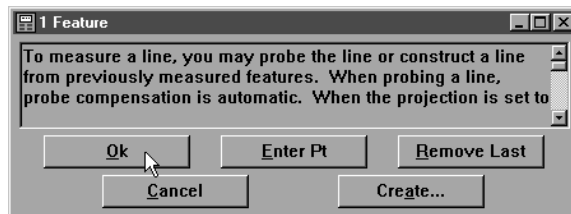



## Circle Constructions

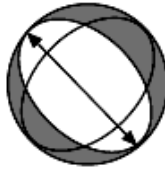

### Circle Constructed from a Sphere

#### To construct a circle from a sphere

##### Step 1

Use the mouse to highlight a sphere on the features list.

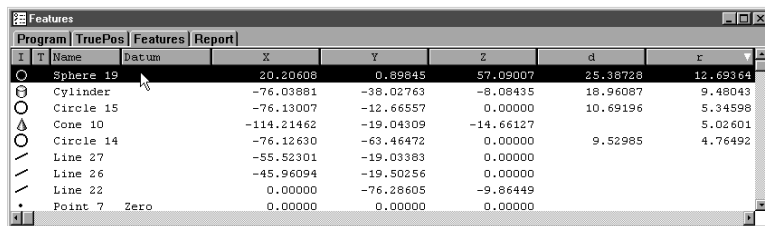

##### Step 2

Click on the projection box in the status bar until the desired projection (XY, YZ, ZX) plane appears.



##### Step 3

Click the circle button on the measure toolbar.

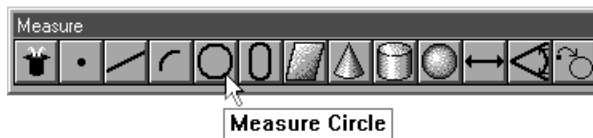

##### Step 4

Click OK in the dialog box.

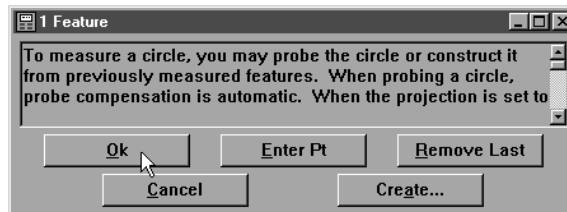

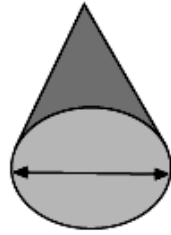

**Circle Constructed from a Cone**

**To construct a circle from a cone**

Step 1

Use the mouse to highlight a cone on the features list.

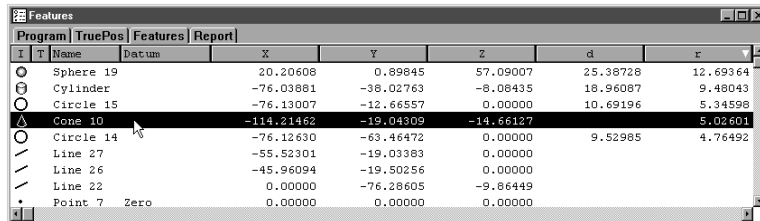

Step 2

Click the circle button on the measure toolbar.

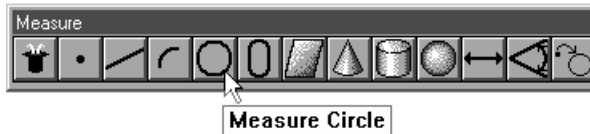

Step 3

Click OK in the dialog box.

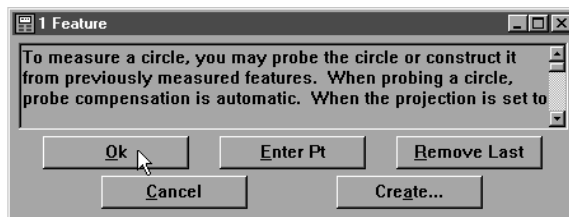

Step 4

Enter the desired radius in the gage circle dialog box and click OK.

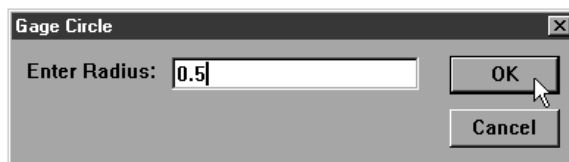

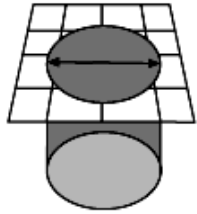

### Circle Constructed from an Intersecting Plane and Cylinder

To construct a circle from an intersecting plane and cylinder

Step 1

Use the mouse to highlight a cylinder and a plane on the features list.

I	T	Name	Datum	X	Y	Z	d	r
○		Sphere 19		20.20608	0.89845	57.09007	25.38728	12.69364
○		Cylinder		-76.03881	-38.02763	-8.08435	18.96087	9.48043
○		Circle 15		-76.13007	-12.66557	0.00000	10.69196	5.34598
△		Cone 10		-114.21462	-19.04309	-14.66127		5.02601
○		Circle 14		-76.12630	-63.46472	0.00000	9.52985	4.76492
/		Line 22		0.00000	-76.28605	-9.86449		
•		Point 7	Zero	0.00000	0.00000	0.00000		
/		Plane 4	Primary	-81.41003	-38.34949	0.00000		
/		Line 5	Skew	-56.13519	0.00000	0.00000		

Step 2

Click the circle button on the measure toolbar.

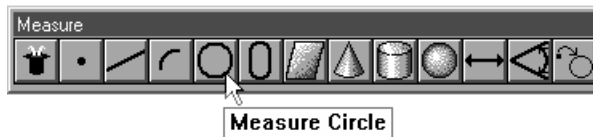

Step 3

Click OK in the dialog box.

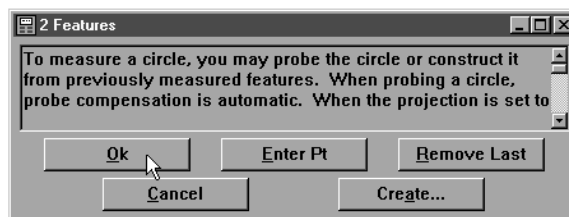

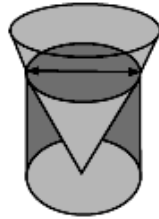

**Circle Constructed from an Intersecting Cylinder and Cone**

To construct a circle from an intersecting cylinder and cone

Step 1

Use the mouse to highlight a cylinder and a cone on the features list.

Features								
Program		TruePos	Features	Report				
I	T	Name	Datum	X	Y	Z	r	
○		Sphere 19		20.20608	0.89845	57.09007	25.38728	12.69364
○		Cylinder		-76.03881	-38.02763	-8.08435	18.96087	9.48043
○		Circle 15		-76.13007	-12.66557	0.00000	10.69196	5.34598
△		Cone 10		-114.21462	-19.04309	-14.66127		5.02601
○		Circle 14		-76.12630	-63.46472	0.00000	9.52985	4.76492
—		Line 22		0.00000	-76.28605	-9.86449		
•		Point 7	Zero	0.00000	0.00000	0.00000		
□		Plane 4	Primary	-81.41003	-38.34949	0.00000		
—		Line 5	Skew	-56.13519	0.00000	0.00000		

Step 2

Click the circle button on the measure toolbar.

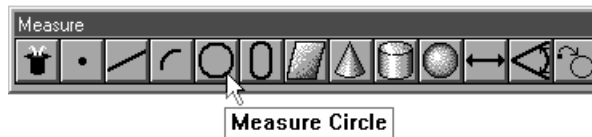

Step 3

Click OK in the dialog box.

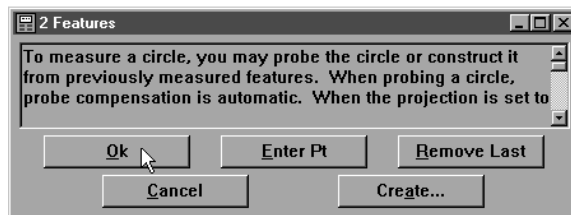

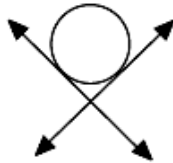

### Circle Constructed Tangent to 2 Intersecting Lines

#### To construct a circle tangent to 2 intersecting lines

##### Step 1

Use the mouse to highlight 2 intersecting lines on the features list.

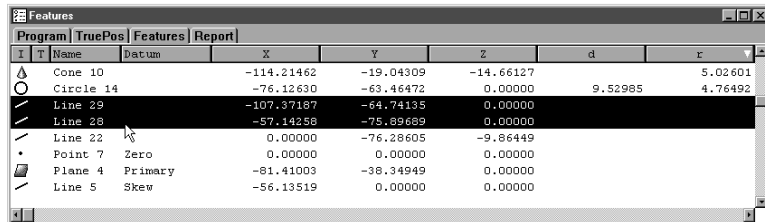

##### Step 2

Click the circle button on the measure toolbar.

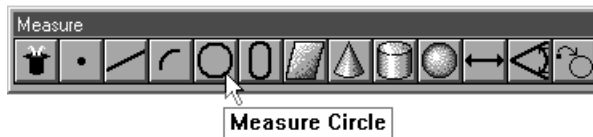

##### Step 3

Click OK in the dialog box.

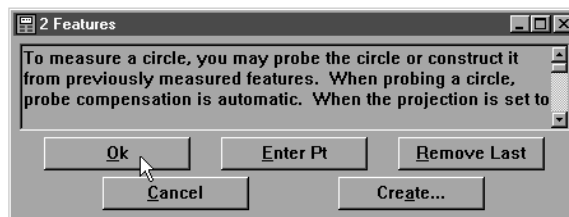

##### Step 4

Enter the desired radius in the gage circle dialog box and click OK.



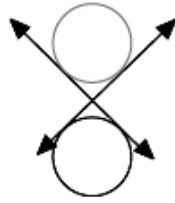

### Changing the Location of a Tangent Circle Construction

#### To change the location of a tangent circle

##### Step 1

Use the mouse to highlight the tangent circle on the features list.

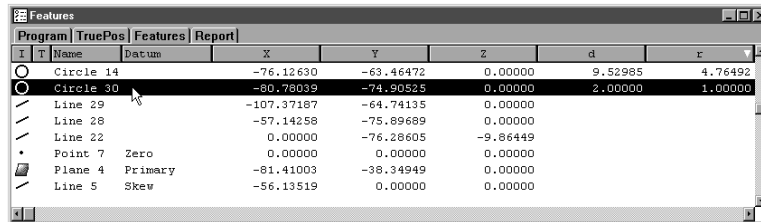

##### Step 2

Right click in the results window and select tangent 1, tangent 2, tangent 3, or tangent 4 from the list.

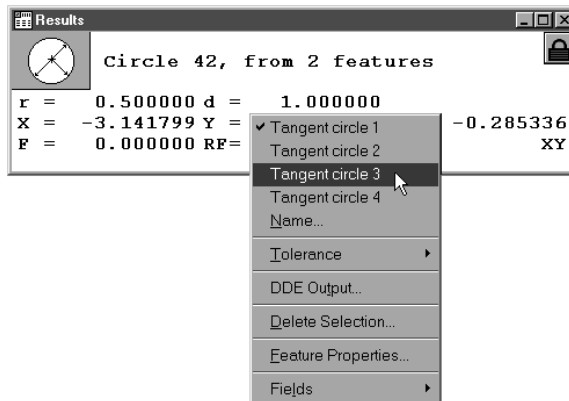

## Plane Constructions

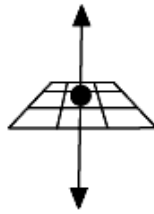

**Plane Constructed from the Midpoint of a Line**

### To construct a plane from the midpoint of a line

#### Step 1

Use the mouse to highlight a line on the features list.

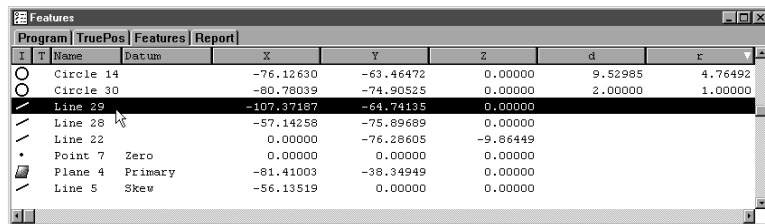

#### Step 2

Click the plane button on the measure toolbar.

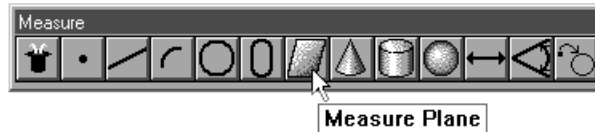

#### Step 3

Click OK in the dialog box.

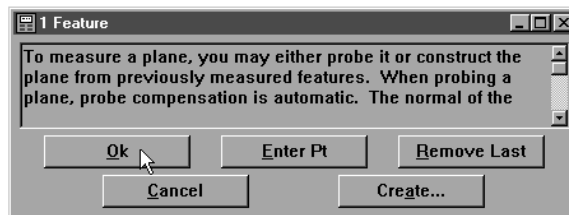

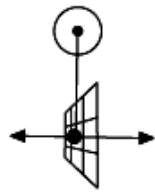

**Plane Constructed from a Line and a Positional Feature**

**To construct a plane from a line and a positional feature**

Step 1

Use the mouse to highlight a line and a positional feature on the features list.

Features								
		Program	TruePos	Features	Report			
I	T	Name	Datum	X	Y	Z	r	d
/		Line 2	Skew	-68.40934	0.00000	0.00000		
/		Line 3		0.02896	-38.65587	0.00000		
•		Point 4	Zero	0.00000	0.00000	0.00000		
○		Circle 5		-76.11771	-38.07186	0.00000	9.95266	19.90532
/		Line 6		-133.28028	-36.05004	0.00000		
/		Line 7		-109.75734	-63.95045	0.00000		
/		Line 8		-59.14086	-76.14959	0.00000		

Step 2

Click the plane button on the measure toolbar.

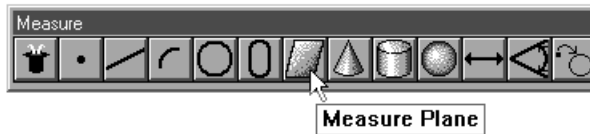

Step 3

Click OK in the dialog box.

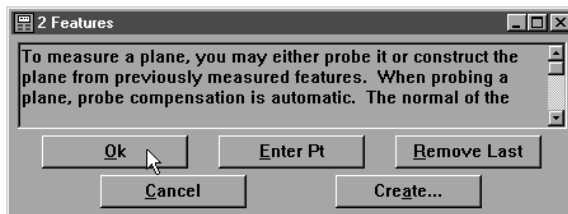



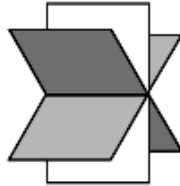

**Midplane Constructed from 2 planes (Midplane 1)**

**To construct a midplane from 2 planes**

Step 1

Use the mouse to highlight 2 planes on the features list.

Features								
Program		TruePos	Features			Report		
I	T	Name	Datum	X	Y	Z	d	r
		Circle 30		-80.78039	-74.90525	0.00000	2.00000	1.00000
		Plane 31		-15.67173	-38.02728	-4.47516		
		Line 29		-107.37187	-64.74135	0.00000		
		Line 28		-57.14258	-75.89689	0.00000		
		Line 22		0.00000	-76.28605	-9.86449		
		Point 7	Zero	0.00000	0.00000	0.00000		
		Plane 4	Primary	-81.41003	-38.34949	0.00000		
		Line 5	Skew	-56.13519	0.00000	0.00000		

Step 2

Click the plane button on the measure toolbar.

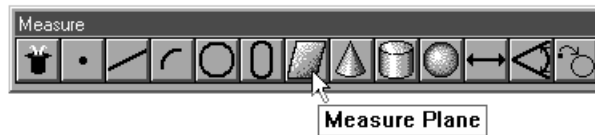

Step 3

Click OK in the dialog box.

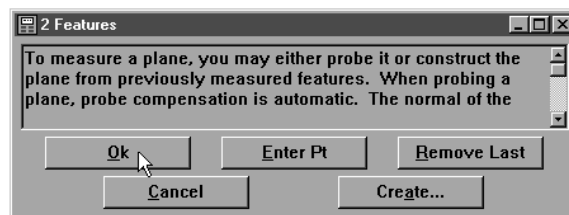

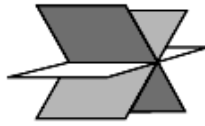

**Midplane Constructed from 2 planes (Midplane 2)**

**To construct a perpendicular midplane from 2 planes**

Step 1

Use the mouse to highlight 2 planes on the features list.

Features							
Program		TruePos	Features		Report		
I	T	Name	Datum	X	Y	Z	d
		Circle 30		-80.78039	-74.90525	0.00000	2.00000
		Plane 31		-15.87173	-38.02728	-4.47516	1.00000
		Line 29		-107.37187	-64.74135	0.00000	
		Line 28		-57.14258	-75.89689	0.00000	
		Line 22		0.00000	-76.28605	-9.86449	
		Point 7 Zero		0.00000	0.00000	0.00000	
		Plane 4 Primary		-81.41003	-38.34949	0.00000	
		Line 5 Skew		-56.13519	0.00000	0.00000	

Step 2

Click the plane button on the measure toolbar.

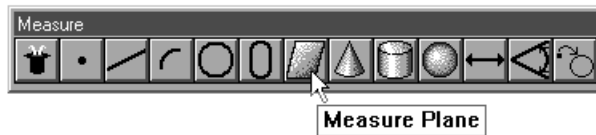

Step 3

Click OK in the dialog box.

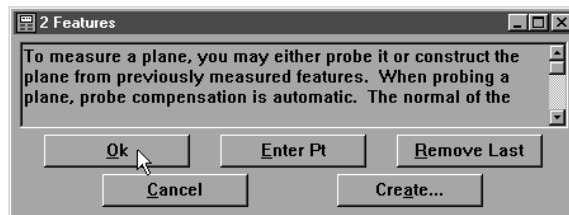

Step 4

Right click in the results window and select midplane 2 from the list.

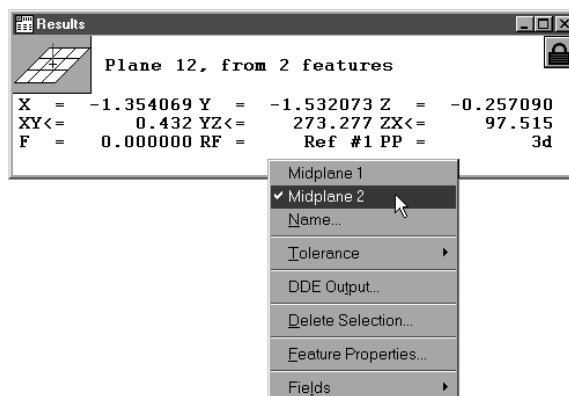

## Sphere Constructions



### Sphere Constructed from a Cone

#### To construct a sphere from a cone

##### Step 1

Using the mouse to highlight a cone on the features list.

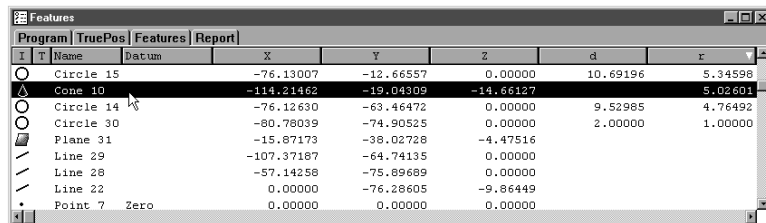

##### Step 2

Click the sphere button on the measure toolbar.



##### Step 3

Click OK in the dialog box.

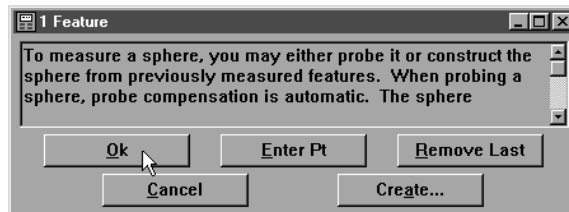

##### Step 4

Enter the desired radius in the gage ball dialog box and click OK.

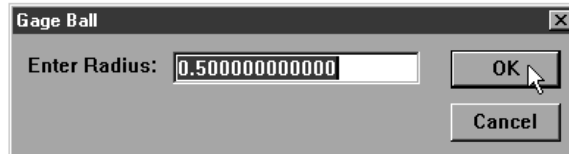

## Chapter 4 General Measuring Cylinder Constructions

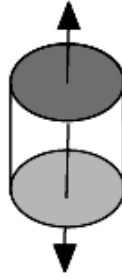

### Cylinder Constructed from 2 Co-axial Circles

#### To construct a cylinder from to 2 co-axial circles

##### Step 1

Use the mouse to highlight 2 co-axial circles on the features list.

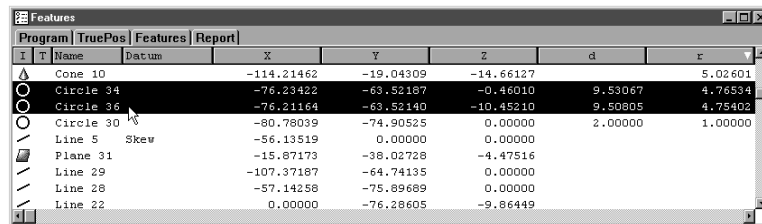

I	T	Name	Datum	X	Y	Z	d	r
		Cone 10		-114.21462	-19.04309	-14.66127		5.02601
		Circle 34		-76.23422	-63.52187	-0.46010	9.53067	4.76534
		Circle 36		-76.21164	-63.52140	-10.45210	9.50805	4.75402
		Circle 30		-80.78039	-74.90525	0.00000	2.00000	1.00000
		Line 5	Skew	-56.13519	0.00000	0.00000		
		Plane 31		-15.87173	-38.02728	-4.47516		
		Line 29		-107.37187	-64.74135	0.00000		
		Line 28		-57.14258	-75.89689	0.00000		
		Line 22		0.00000	-76.28605	-9.86449		

##### Step 2

Click the cylinder button on the measure toolbar.



##### Step 3

Click OK in the dialog box.

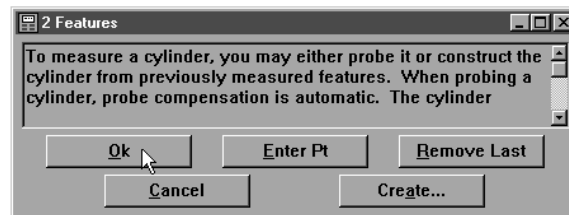

## Cone Constructions

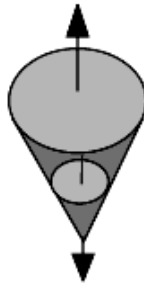

**Cone Constructed from 2 Co-axial Circles**

### To construct a cone from 2 co-axial circles

#### Step 1

Use the mouse to highlight 2 co-axial circles (with different diameters) on the features list.

I	T	Name	Datum	X	Y	Z	d	r
		Cone 10		-114.21462	-19.04309	-14.66127		5.02601
		Circle 34		-76.23422	-63.52187	-0.46010	9.53067	4.76534
		Circle 36		-76.21164	-63.52140	-10.45210	9.50805	4.75402
		Circle 30		-80.78039	-74.90525	0.00000	2.00000	1.00000
		Line 5	Skew	-56.13519	0.00000	0.00000		
		Plane 31		-15.87173	-38.02728	-4.47516		
		Line 29		-107.37187	-64.74135	0.00000		
		Line 28		-57.14258	-75.89689	0.00000		
		Line 22		0.00000	-76.28605	-9.86449		

#### Step 2

Click the cone button on the measure toolbar.

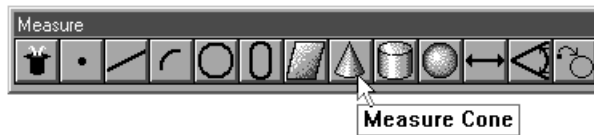

#### Step 3

Click OK in the dialog box.

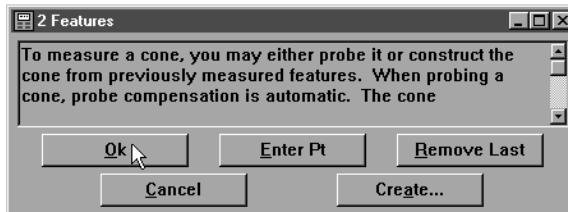

### Measuring Relations

There are two types of relations used by the QC5000 software: distances and angles. Distances describe how far one feature is from another and angles describe where one feature lies in relation to another.

#### **Distance**

Distances are constructed using previously measured features. The simplest distance to construct is between two points. More complex distances can be constructed between two circles or by a combination of features such as a circle and a point. The basic method for constructing distances is the same as below.

#### **Angle**

Angles are constructed using previously measured features. The simplest angle to construct is between two lines. More complex angles can be constructed between two planes or by a combination of features such as a cylinder and a plain. The basic method for constructing angles is the same as below.

## Distance Constructions

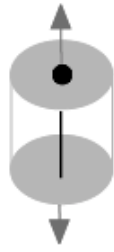

**Length of an Axis**

### To construct the length of an axis

#### Step 1

Use the mouse to highlight a linear feature on the features list.

Features							
Program		TruePos	Features		Report		
I	T	Name	Datum	X	Y	Z	r
		Cone 10		-114.21462	-19.04309	-14.66127	5.02601
		Circle 34		-76.23422	-63.52187	-0.46010	4.76534
		Circle 36		-76.21164	-63.52140	-10.45210	4.75402
		Circle 30		-80.78039	-74.90525	0.00000	1.00000
		Line 5	Skew	-56.13519	0.00000	0.00000	
		Plane 31		-15.87173	-38.02728	-4.47516	
		Line 29		-107.37187	-64.74135	0.00000	
		Line 28		-57.14258	-75.89689	0.00000	
		Line 22		0.00000	-76.28605	-9.86449	

#### Step 2

Click the distance button on the measure toolbar.



#### Step 3

Click OK in the dialog box.

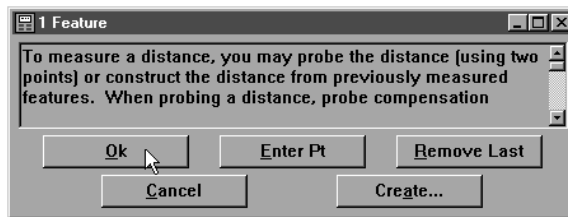

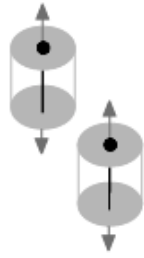

### Duplicate Distance

#### To construct a duplicate distance

Step 1

Use the mouse to highlight a distance on the features list.

I	T	Name	Datum	X	Y	Z	d	r
←		Distance		0.00000	75.89689	0.00000		
/		Line 5	Skew	-56.13519	0.00000	0.00000		
/		Plane 31		-15.87173	-38.02728	-4.47516		
/		Line 29		-107.37187	-64.74135	0.00000		
/		Line 28		-57.14258	-75.89689	0.00000		
/		Line 22		0.00000	-76.28605	-9.86449		
•		Point 7	Zero	0.00000	0.00000	0.00000		
/		Plane 4	Primary	-81.41003	-38.34949	0.00000		

Step 2

Click the distance button on the measure toolbar.



Step 3

Click OK in the dialog box.

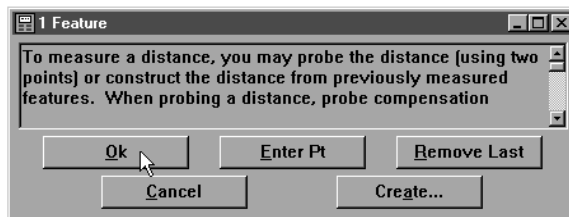



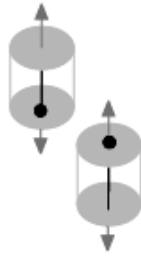

## Reverse Direction Distance

### To construct a reverse direction distance

#### Step 1

Use the mouse to highlight a duplicate distance on the features list.

Features							
Program   TruePos   Features   Report							
I	T	Name	Datum	X	Y	Z	r
		Circle 30		-80.78039	-74.90525	0.00000	2.00000
		Distance		0.14133	0.09306	16.16870	1.00000
		Distance		0.14133	0.09306	16.16870	
		Line 5 Skew		-56.13519	0.00000	0.00000	
		Plane 31		-15.87173	-38.02728	-4.47516	
		Line 29		-107.37187	-64.74135	0.00000	
		Line 28		-57.14258	-75.89689	0.00000	
		Line 22		0.00000	-76.28605	-9.86449	
		Point 7 Zero		0.00000	0.00000	0.00000	

#### Step 2

Click the distance button on the measure toolbar.



#### Step 3

Right click in the results window and select reverse distance from the list.

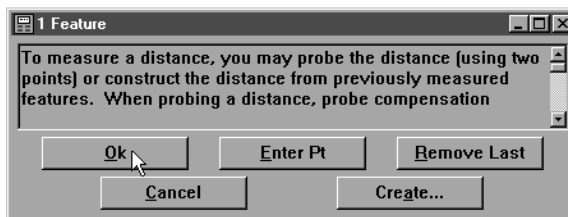

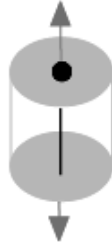

### Absolute Distance

#### To construct an absolute distance

##### Step 1

Use the mouse to highlight a duplicate distance on the features list.

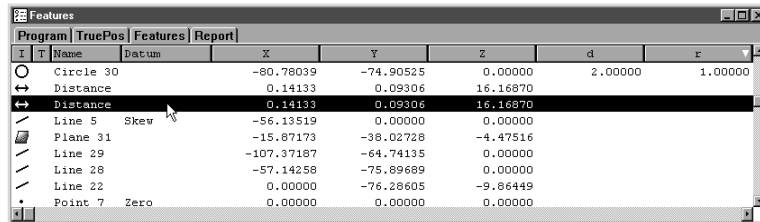

##### Step 2

Click the distance button on the measure toolbar.



##### Step 3

Click OK in the dialog box.

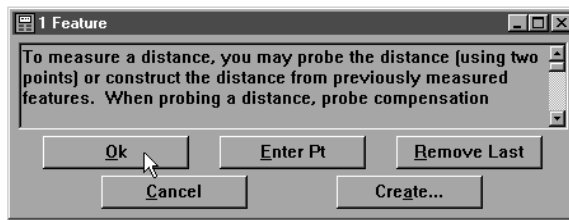

##### Step 4

Right click in the results window and select absolute distance from the list.

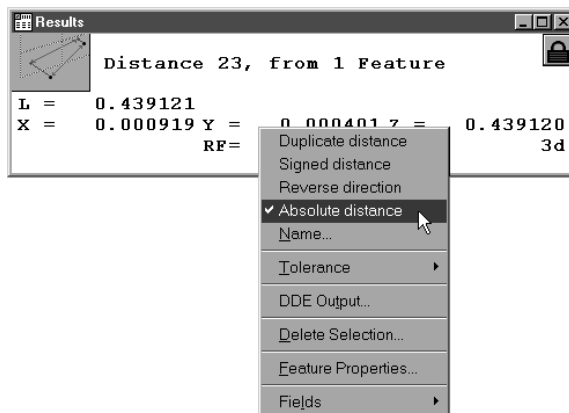

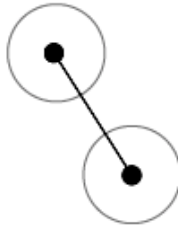

**Distance Constructed from Center to Center of 2 Positional Features**

**To construct a center to center distance**

**Step 1**

Use the mouse to highlight 2 positional features on the features list.

Features								
		Program	TruePos	Features	Report			
I	T	Name	Datum	X	Y	Z	d	r
		Sphere 19		20.20608	0.89845	57.09007	25.38728	12.69364
		Cone 10		-114.21462	-19.04309	-14.66127		5.02601
		Circle 43		-76.22959	-63.52107	0.00000	9.52508	4.76254
		Circle 40		-76.42521	-12.78369	0.00000	9.51376	4.75688
		Circle 30		-80.78039	-74.90525	0.00000	2.00000	1.00000
		Line 5	Skew	-56.13519	0.00000	0.00000		
		Plane 31		-15.87173	-38.02728	-4.47516		
		Line 29		-107.37187	-64.74135	0.00000		
		Line 28		-57.14258	-75.89689	0.00000		

**Step 2**

Click the distance button on the measure toolbar.



**Step 3**

Click OK in the dialog box.

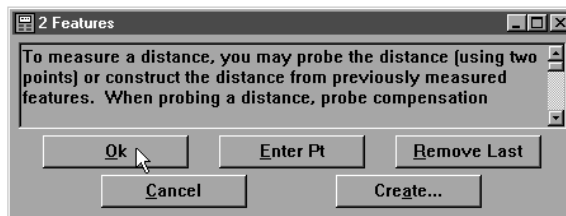

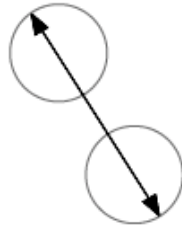

### Distance Constructed from the Farthest Edge of 2 Positional Features

#### To construct a farthest edge distance

##### Step 1

Use the mouse to highlight 2 positional features on the features list.

Features									
		Program	TruePos	Features	Report				
I	T	Name	Datum		X	Y	Z	d	r
		Sphere 19			20.20608	0.89845	57.09007	25.38728	12.69364
		Cone 10			-114.21462	-19.04309	-14.66127		5.02601
		Circle 43			-76.22959	-63.52107	0.00000	9.52508	4.76254
		Circle 40			-76.42521	-12.78369	0.00000	9.51376	4.75688
		Circle 30			-80.78039	-74.90525	0.00000	2.00000	1.00000
		Line 5	Skew		-56.13519	0.00000	0.00000		
		Plane 31			-15.87173	-38.02728	-4.47516		
		Line 29			-107.37187	-64.74135	0.00000		
		Line 28			-57.14258	-75.89689	0.00000		

##### Step 2

Click the distance button on the measure toolbar.



##### Step 3

Click OK in the dialog box.

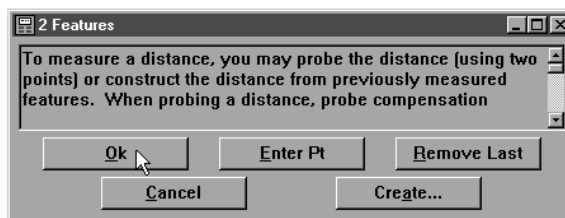

##### Step 4

Right click in the results window and select farthest distance from the list.

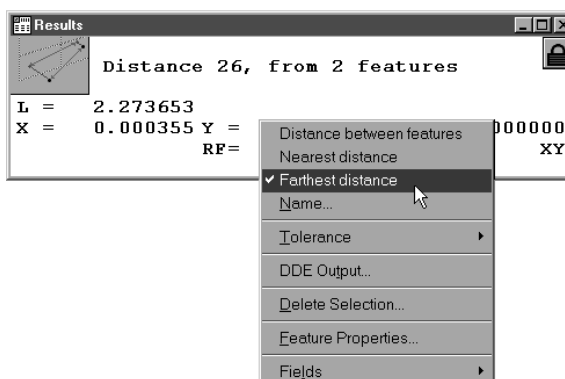

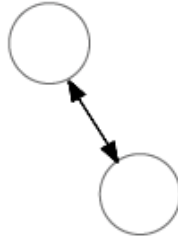

### Distance Constructed from the Nearest Edge of 2 Positional Features

#### To construct a nearest edge distance

##### Step 1

Use the mouse to highlight 2 positional features on the features list.

Features								
		Program	TruePos	Features	Report			
I	T	Name	Datum	X	Y	Z	d	r
		Sphere 19		20.20608	0.89845	57.09007	25.38728	12.69364
		Cone 10		-114.21462	-19.04309	-14.66127		5.02601
		Circle 43		-76.22959	-63.52107	0.00000	9.52508	4.76254
		Circle 40		-76.42521	-12.78369	0.00000	9.51376	4.75688
		Circle 30		-80.78039	-74.90525	0.00000	2.00000	1.00000
		Line 5	Skew	-56.13519	0.00000	0.00000		
		Plane 31		-15.87173	-38.02728	-4.47516		
		Line 29		-107.37187	-64.74135	0.00000		
		Line 28		-57.14258	-75.89689	0.00000		

##### Step 2

Click the distance button on the measure toolbar.



##### Step 3

Click OK in the dialog box.

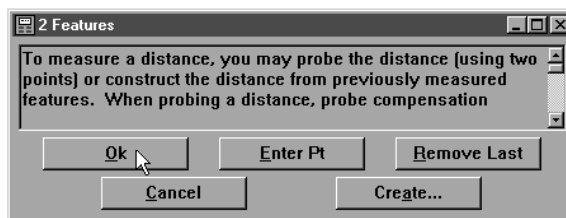

##### Step 4

Right click in the results window and select nearest distance from the list.

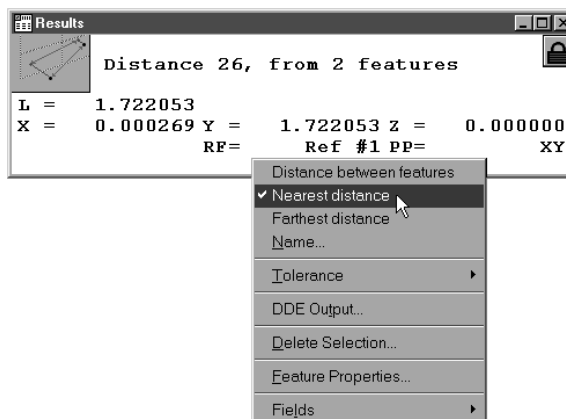

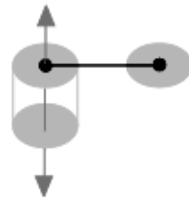

**Distance Constructed from the Center of a Positional Feature to Linear Feature**

To construct a distance from a positional feature perpendicular to a linear feature

Step 1

Use the mouse to highlight a positional feature and a linear feature on the features list.

Features								
Program		TruePos	Features	Report				
I	T	Name	Datum	X	Y	Z	d	r
▲		Cone 10		-114.21462	-19.04309	-14.66127		5.02601
○		Circle 43		-76.22959	-63.52107	0.00000	9.52508	4.76254
○		Circle 40		-76.42521	-12.78369	0.00000	9.51376	4.75688
○		Circle 30		-80.78039	-74.90525	0.00000	2.00000	1.00000
—		Line 5	Skew	-56.13519	0.00000	0.00000		
—		Plane 31		-15.87173	-38.02728	-4.47516		
—		Line 29		-107.37187	-64.74135	0.00000		
—		Line 28		-57.14258	-75.89689	0.00000		
—		Line 22		0.00000	-76.28605	-9.86449		

Step 2

Click the distance button on the measure toolbar.



Step 3

Click OK in the dialog box.

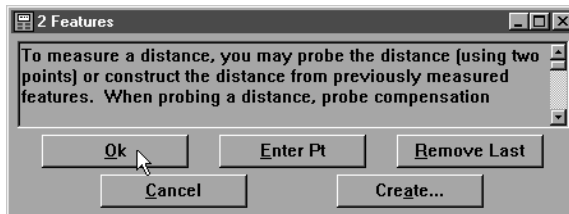

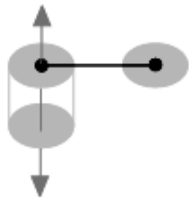

**Distance Constructed from the Center of a Positional Feature to Linear Feature**

**To construct the nearest to line distance**

**Step 1**

Use the mouse to highlight a circle (or arc) and a line on the features list.

Program	TruePos	Features	Report						
I	T	Name	Datum	X	Y	Z	d	r	
		Cone 10		-114.21462	-19.04309	-14.66127			
		Circle 43		-76.22959	-63.52107	0.00000	9.52508	4.76254	
		Circle 40		-76.42521	-12.78369	0.00000	9.51376	4.75688	
		Circle 30		-80.78039	-74.90525	0.00000	2.00000	1.00000	
		Line 5 Skew		-56.13519	0.00000	0.00000			
		Plane 31		-15.87173	-38.02728	-4.47516			
		Line 29		-107.37187	-64.74135	0.00000			
		Line 28		-57.14258	-75.89689	0.00000			
		Line 22		0.00000	-76.28605	-9.86449			

**Step 2**

Click the distance button on the measure toolbar.



**Step 3**

Click OK in the dialog box.

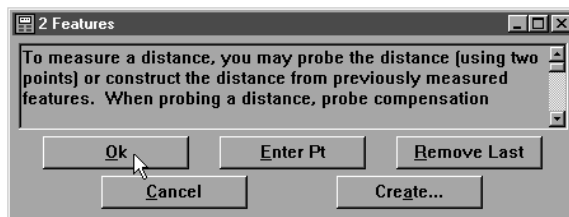

**Step 4**

Right click in the results window and select nearest to line distance from the list.

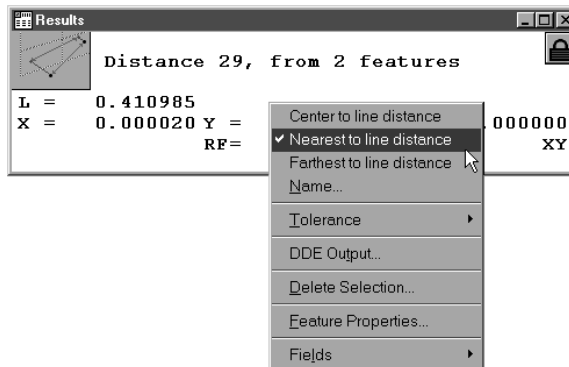



**To construct the farthest to line distance**

**Step 1**

Use the mouse to highlight a circle (or arc) and a line on the features list.

Program		TruePos	Features	Report					
I	T	Name	Datum	X	Y	Z	d	r	
		Sphere 19		20.20608	0.89845	57.09007	25.38728	12.69364	
		Cone 10		-114.21462	-19.04309	-14.66127		5.02601	
		Circle 43		-76.22959	-63.52107	0.00000	9.52508	4.76254	
		Circle 40		-76.42521	-12.78369	0.00000	9.51376	4.75688	
		Circle 30		-80.78039	-74.90525	0.00000	2.00000	1.00000	
		Line 5	Skew	-56.13519	0.00000	0.00000			
		Plane 31		-15.87173	-38.02728	-4.47516			
		Line 29		-107.37187	-64.74135	0.00000			
		Line 28		-57.14258	-75.89689	0.00000			

**Step 2**

Click the distance button on the measure toolbar.



**Step 3**

Click OK in the dialog box.

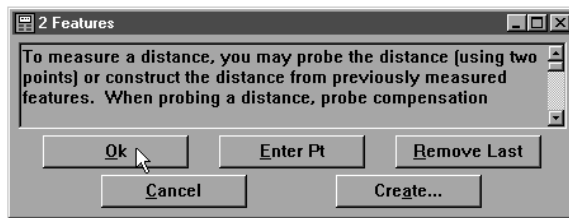

**Step 4**

Right click in the results window and select farthest to line distance from the list.

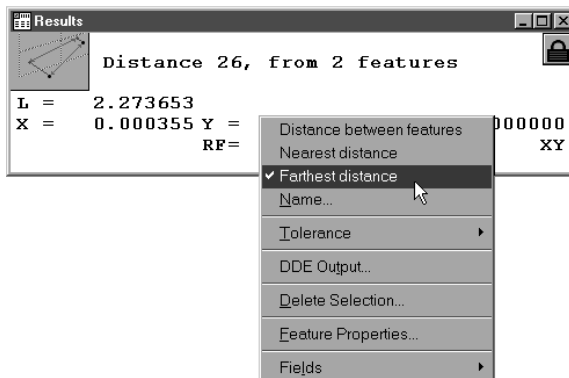



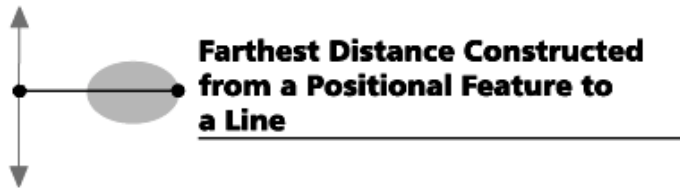

**To construct a distance from a positional feature to a plane**

**Step 1**

Use the mouse to highlight a positional feature and a plane on the features list.

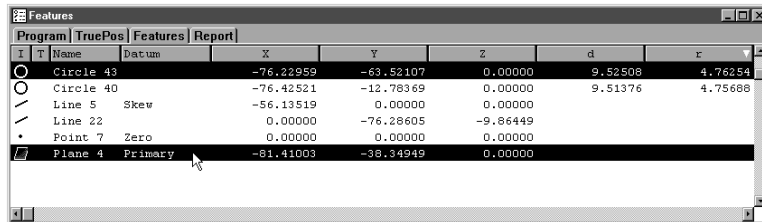

**Step 2**

Click the distance button on the measure toolbar.



**Step 3**

Click OK in the dialog box.

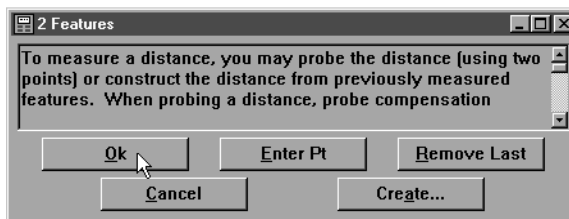



**To construct a center to plane distance from a sphere**

**Step 1**

Use the mouse to highlight a sphere and a plane on the features list.

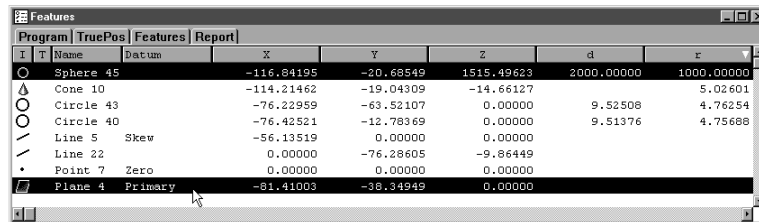

**Step 2**

Click the distance button on the measure toolbar.



**Step 3**

Click OK in the dialog box.

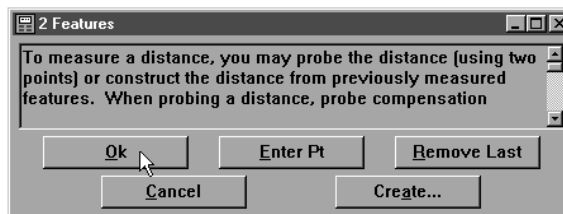

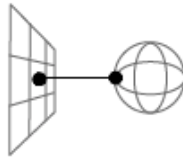

### Distance Constructed from the Nearest Point on a Sphere to a Plane

#### To construct the nearest plane distance from a sphere

##### Step 1

Use the mouse to highlight a sphere and a plane on the features list.

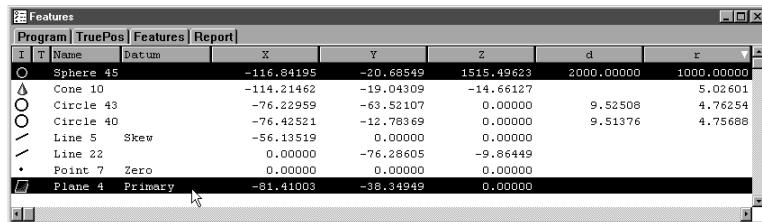

##### Step 2

Click the distance button on the measure toolbar.



##### Step 3

Click OK in the dialog box.

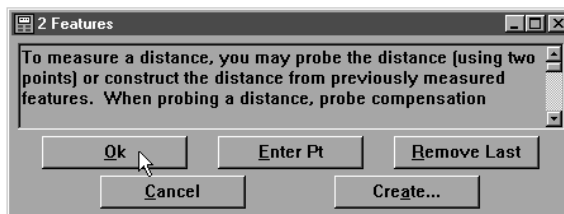

##### Step 4

Right click in the results window and select nearest plane distance from the list.

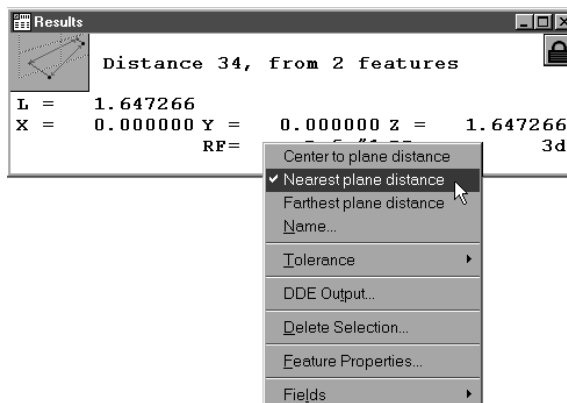

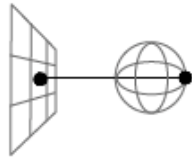

**Distance Constructed from the Farthest Point on a Sphere to a Plane**

To construct the farthest plane distance from a sphere

Step 1

Use the mouse to highlight a sphere and a plane on the features list.

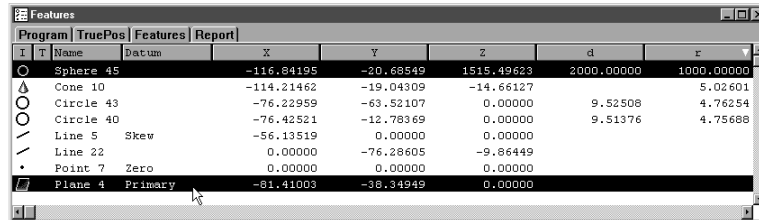

Step 2

Click the distance button on the measure toolbar.



Step 3

Click OK in the dialog box.

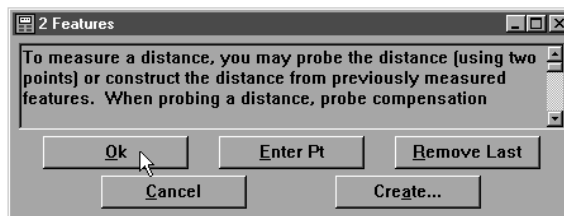

Step 4

Right click in the results window and select farthest plane distance from the list.

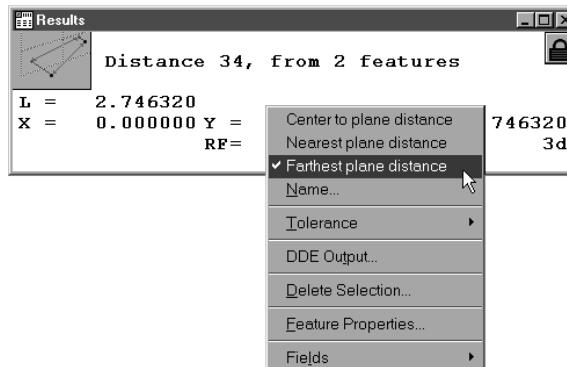

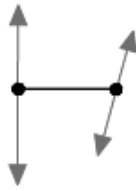

### Distance Constructed from 2 lines (Bounded Line)

#### To construct a bounded line distance from 2 lines

##### Step 1

Use the mouse to highlight 2 lines on the features list.

Features								
		Program	TruePos	Features	Report			
I	T	Name	Datum	X	Y	Z	d	r
○		Circle 43		-76.22959	-63.52107	0.00000	9.52508	4.76254
○		Circle 40		-76.42521	-12.78369	0.00000	9.51376	4.75688
□		Plane 48		-82.99210	-38.44109	-0.00015		
—		Line 47		-46.23867	-17.24484	0.00000		
—		Line 46		-55.79286	-19.50746	0.00000		
—	Skew	Line 5		-56.13519	0.00000	0.00000		
—		Line 22		0.00000	-76.28605	-9.86449		
•	Zero	Point 7		0.00000	0.00000	0.00000		

##### Step 2

Click the distance button on the measure toolbar.



##### Step 3

Click OK in the dialog box

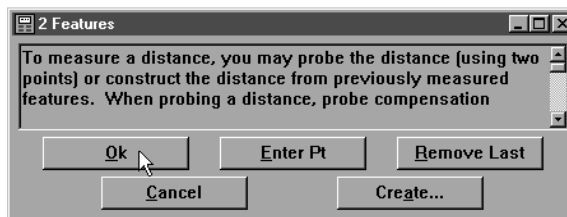



**Distance Constructed from 2 lines  
(Nearest Bounded Line)**

To construct a nearest bounded line distance from 2 lines

Step 1

Use the mouse to highlight 2 lines on the features list.

I	T	Name	Datum	X	Y	Z	d	r
○		Circle 43		-76.22959	-63.52107	0.00000	9.52508	4.76254
○		Circle 40		-76.42521	-12.78369	0.00000	9.51376	4.75688
□		Plane 48		-82.99210	-38.44109	-0.00015		
—		Line 47		-46.23867	-17.24484	0.00000		
—		Line 46		-56.79286	-19.50746	0.00000		
—		Line 5 Skew		-56.13519	0.00000	0.00000		
—		Line 22		0.00000	-76.28605	-9.86449		
•		Point 7 Zero		0.00000	0.00000	0.00000		

Step 2

Click the distance button on the measure toolbar.



Step 3

Click OK in the dialog box.

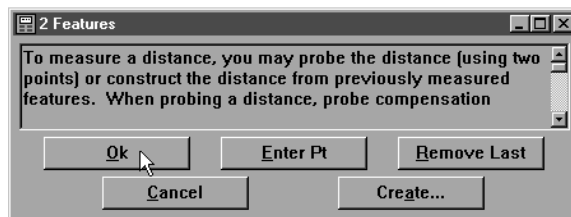

Step 4

Right click in the results window and select nearest bounded line distance from the list.

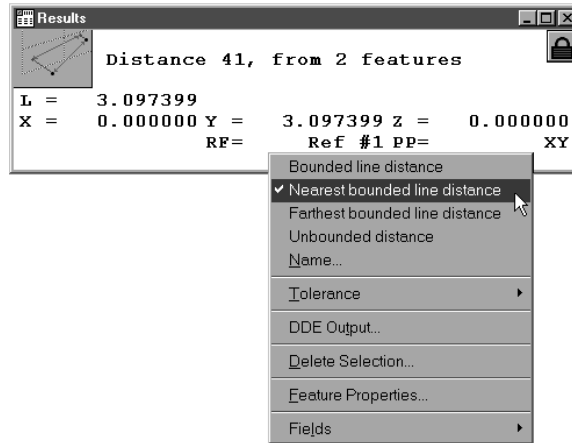

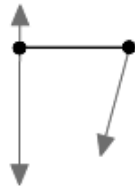

**Distance Constructed from 2 lines  
(Farthest Bounded Line)**

To construct a farthest bounded line distance from 2 lines

Step 1

Use the mouse to highlight 2 lines on the features list.

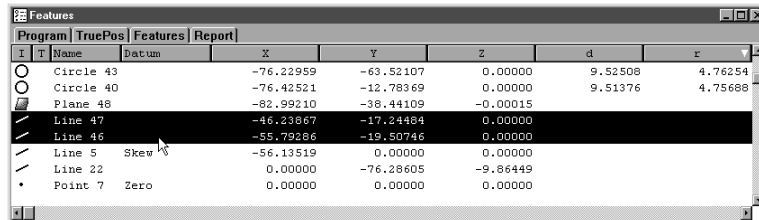

Step 2

Click the distance button on the measure toolbar.



Step 3

Click OK in the dialog box.

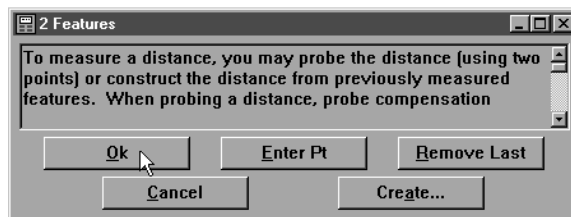



Step 4

Right click in the results window and select farthest bounded line distance from the list.

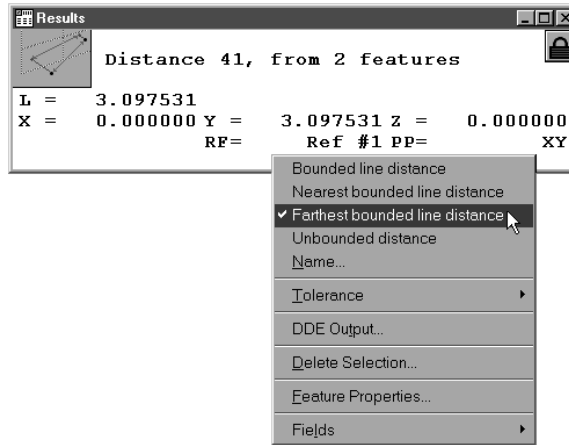

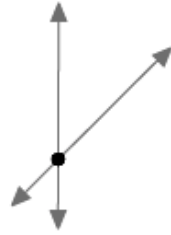

**Distance Constructed from 2 Lines  
(Unbounded Distance)**

To construct an unbounded distance from 2 linear features

Step 1

Use the mouse to highlight 2 linear features on the features list.

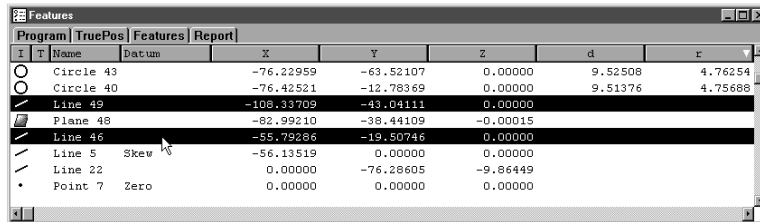

Step 2

Click the distance button on the measure toolbar.



Step 3

Click OK in the dialog box.

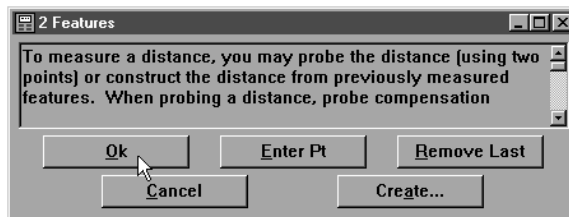

Step 4

Right click in the results window and select unbounded distance from the list.

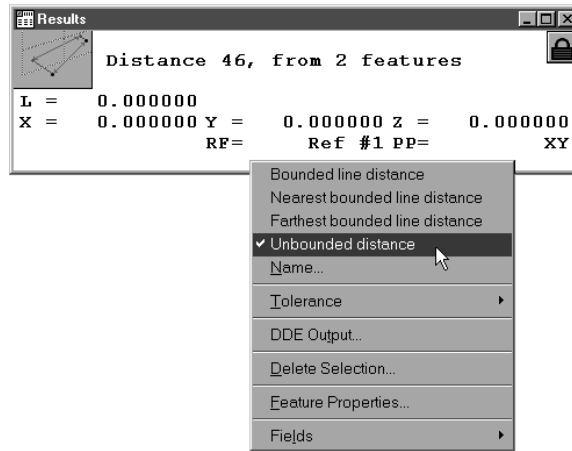

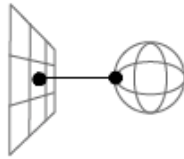

**Distance Constructed from the Nearest Point on a Sphere to a Plane**

**To construct a distance between 2 co-axial planes**

Step 1

Use the mouse to highlight 2 co-axial planes on the features list.

Program	TruePos	Features	Report					
I	T	Name	Datum	X	Y	Z	d	r
		Cone 10		-114.21462	-19.04309	-14.66127		5.02601
		Plane 51		-81.19483	-38.76607	46.02579		
		Plane 48		-82.99210	-38.44109	-0.00015		
		Line 5	skew	-56.13519	0.00000	0.00000		
		Line 22		0.00000	-76.28605	-9.86449		
		Point 7	Zero	0.00000	0.00000	0.00000		

Step 2

Click the distance button on the measure toolbar.



Step 3

Click OK in the dialog box.

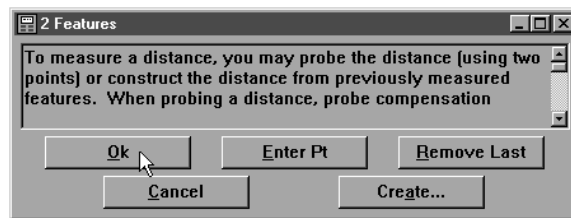

## Angle Constructions

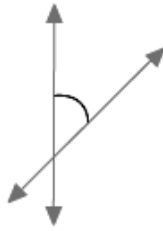

### Angle Constructed from 2 Linear Features

#### To construct an angle from 2 linear features

##### Step 1

Use the mouse to highlight 2 linear features on the features list.

Features							
Program		TruePos	Features		Report		
I	T	Name	Datum	X	Y	Z	r
		Cone 10		-114.21462	-19.04309	-14.66127	5.02601
		Line 53		-108.66420	-33.48240	0.00000	
		Line 52		-46.21031	-18.64324	0.00000	
		Plane 48		-82.99210	-38.44109	-0.00015	
		Line 5	Skew	-56.13519	0.00000	0.00000	
		Line 22		0.00000	-76.28605	-9.86449	
		Point 7	Zero	0.00000	0.00000	0.00000	

##### Step 2

Click the angle button on the measure toolbar.



##### Step 3

Click OK in the dialog box.

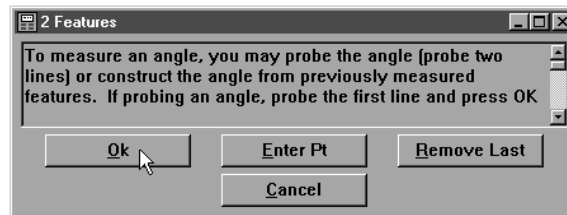

## Chapter 4 General Measuring

### Saving Your Work

Each part file you create is an electronic record of the part and its inspection results. For this reason it is important to save a new part file for each part you inspect.

#### CAUTION

**Create a new file for each part inspected. This ensure a unique record for every inspection. Failing to create a new file for each part will result in loss of data and records.**

#### To save a part file

##### Step 1

Select save as from the file menu.



##### Step 2

Type a name for the part file in the file name text box in the dialog box.

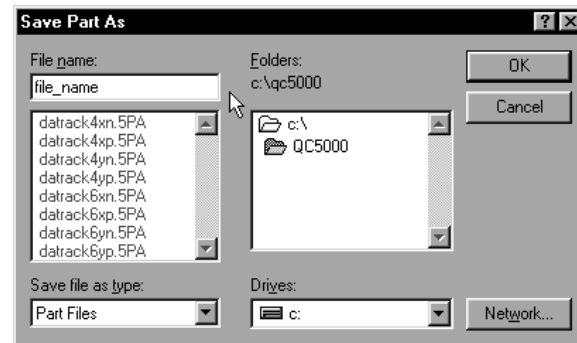

Step 3

Select a storage location for the file using the folders box and/or drives box.

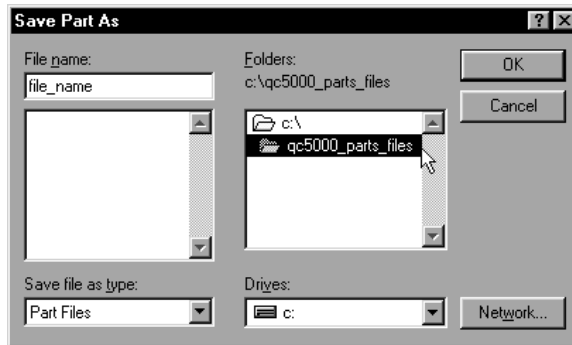

Step 4

Click OK in the dialog box.

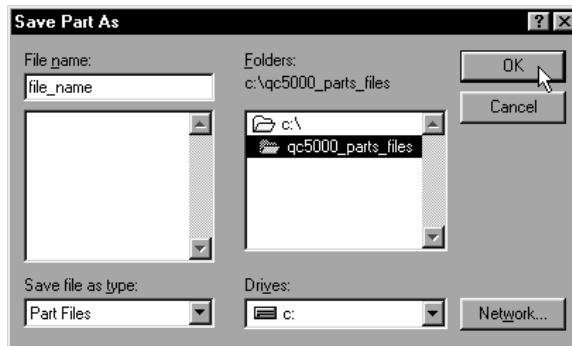

To export to a CAD file

Step 1

Select export from the file menu.

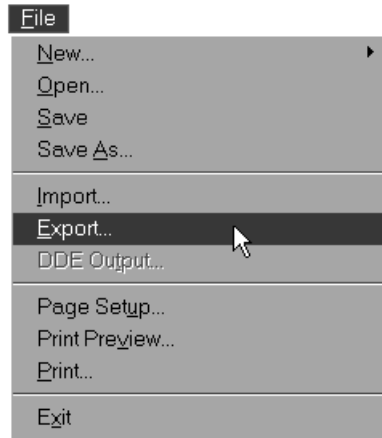

Step 2

Type a name for the part file in the file name text box in the dialog box.

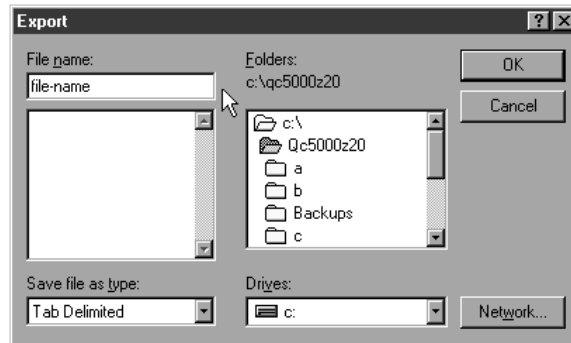

Step 3

Select DXF in the save file as type pull down list.

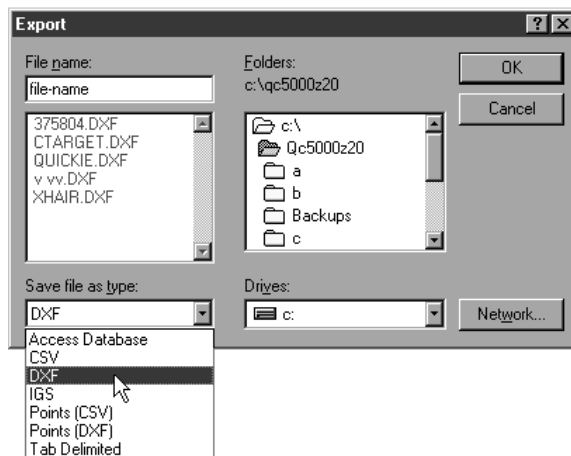



Step 4

Select a storage location for the file using the folders box and/or drives box.

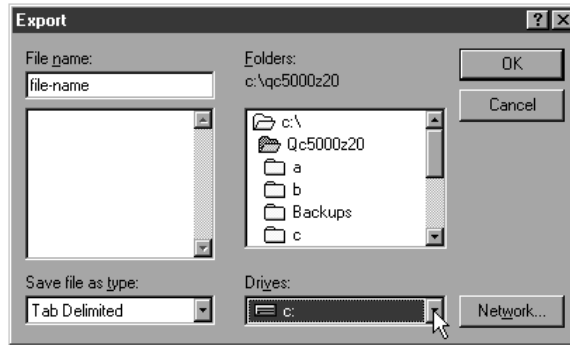

Step 5

Click OK.

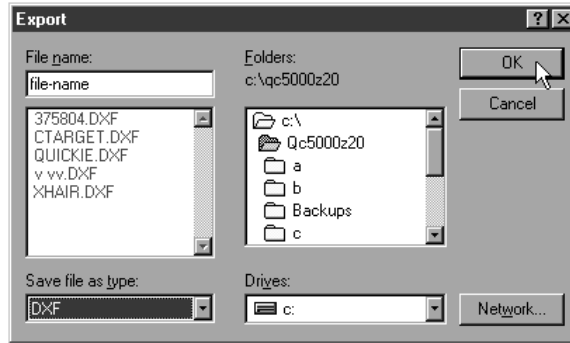

To export to SPC software

Step 1  
Select export from the file menu.

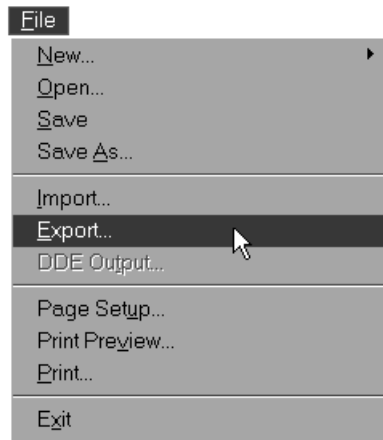

Step 2  
Type a name for the part file in the file name text box in the dialog box.

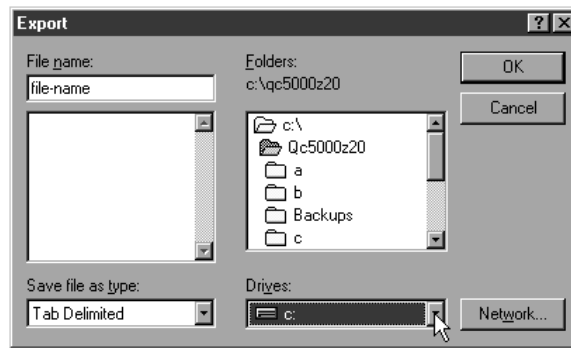

Step 3  
Select tab delimited (or other format specified by SPC software) in the save file as type pull down list.

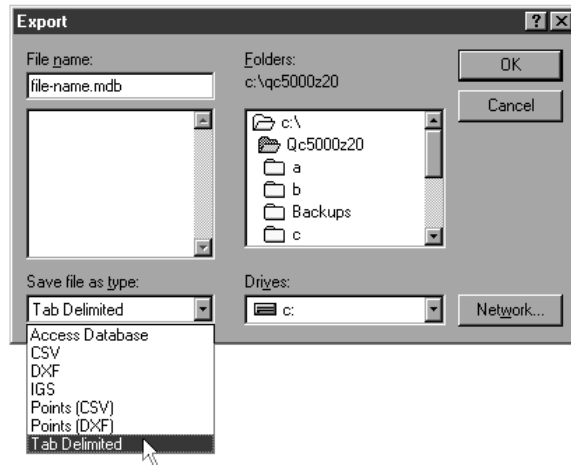

Step 4

Select a storage location for the file using the folders box and/or drives box.

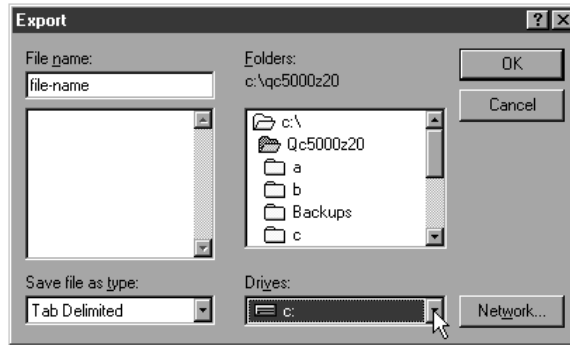

Step 5

Click OK.

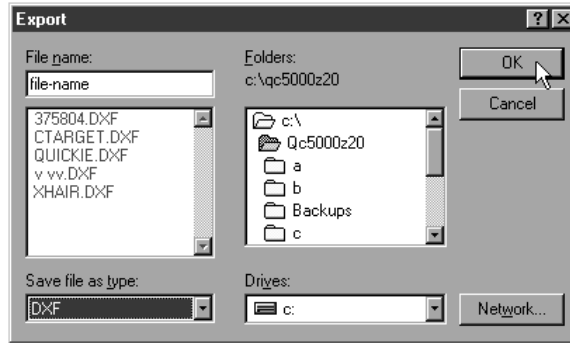

To export to Microsoft Access



Make sure Access is open before exporting. QC5000 data cannot be exported if Access is closed.

Step 1

Select *open template* from the windows menu.

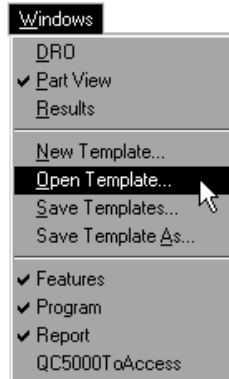

Step 2

Open the *QC5000ToAccess.5ft* template as shown.

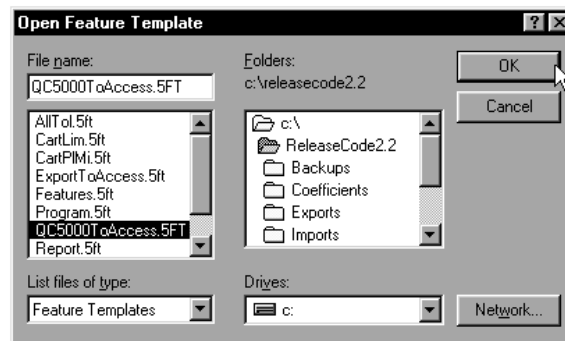

The QC5000ToAccess.5ft template is located in the *c:\qc5000* directory.

The *QC5000ToAccess.5ft* templates appears as shown.

Name	r	d	X	Y	Z
Plane 1			3.25083	1.60275	0.00000
Line 2			2.79112	0.00000	-0.03383
Line 3			-0.00297	1.55535	-0.36903
Point 4			0.00000	0.00000	-0.20143
Cylinder 5	0.32619	0.65238	3.03047	1.53875	-0.27432
Cone 7	0.16165		4.53097	0.78854	-0.55130
Slot 10	0.13918	0.27837	4.34276	1.53850	-0.05525
Circle 13	0.15932	0.31865	3.02648	2.53612	-0.01553
Line 22			4.25858	2.64892	-0.05597
Plane 24			0.64873	1.57736	0.00000

Step 3

Select *export* from the file menu.

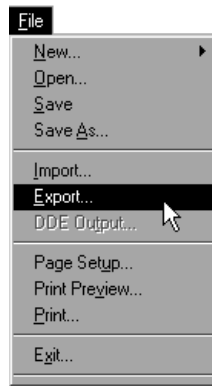

Step 4

Select the desired database as shown and click OK.

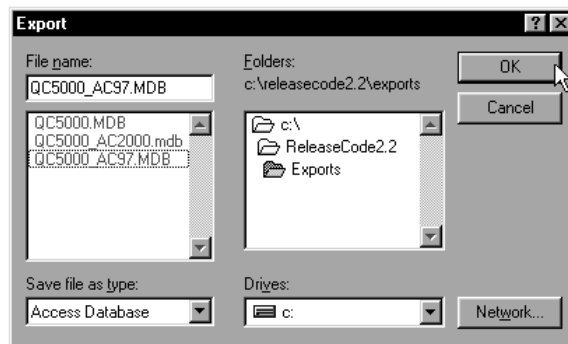

**NOTE**

There are three pre-defined exportable databases. Use *QC5000\_AC2000.mdb* and *QC5000\_AC97.MDB* to export to Access2000 and Access97 respectively. Use *QC5000.mdb* to export to all other database applications.

**NOTE**

Pre-defined databases are stored in the *c:\qc5000\exports* directory.

## Chapter 4 General Measuring

Step 5

Enter the table name as shown and click OK.

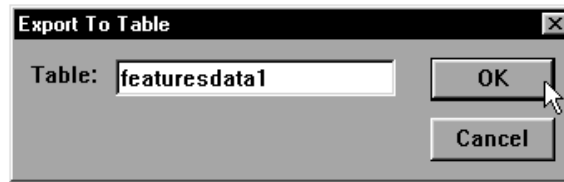

### NOTE

Type the name featuresdata1 when using the pre-defined QC5000 databases.

Step 6

Open Access to view the data in the table.

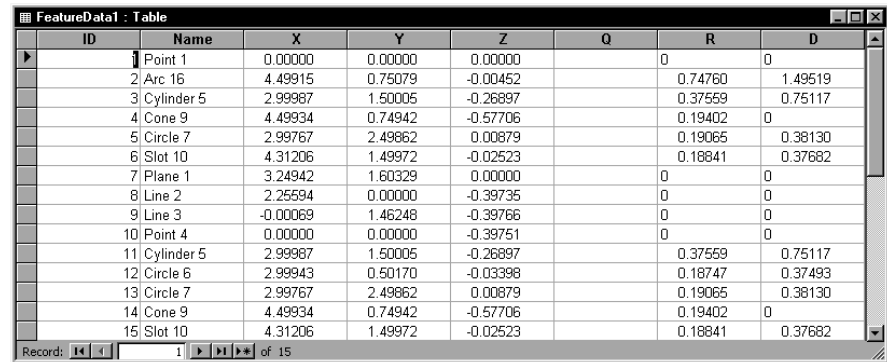

ID	Name	X	Y	Z	Q	R	D
1	Point 1	0.00000	0.00000	0.00000		0	0
2	Arc 16	4.49915	0.75079	-0.00452		0.74760	1.49519
3	Cylinder 5	2.99987	1.50005	-0.26897		0.37559	0.75117
4	Cone 9	4.49934	0.74942	-0.57706		0.19402	0
5	Circle 7	2.99767	2.49862	0.00879		0.19065	0.38130
6	Slot 10	4.31206	1.49972	-0.02523		0.18841	0.37682
7	Plane 1	3.24942	1.60329	0.00000		0	0
8	Line 2	2.25594	0.00000	-0.39735		0	0
9	Line 3	-0.00069	1.46248	-0.39766		0	0
10	Point 4	0.00000	0.00000	-0.39751		0	0
11	Cylinder 5	2.99987	1.50005	-0.26897		0.37559	0.75117
12	Circle 6	2.99943	0.50170	-0.03398		0.18747	0.37493
13	Circle 7	2.99767	2.49862	0.00879		0.19065	0.38130
14	Cone 9	4.49934	0.74942	-0.57706		0.19402	0
15	Slot 10	4.31206	1.49972	-0.02523		0.18841	0.37682

# Chapter 5

## Advanced Measuring & Output

---

### Datum Magic

Datum magic is an automated tool designed to help the user create a datum. A series of dialog boxes guides the user to create the primary plane, secondary alignment, and tertiary alignment. Using datum magic is the fastest and easiest way to establish a datum on most parts.



#### NOTE

**Datum magic requires the use of a primary plane. Primary cones and cylinders are not allowed with datum magic.**

#### To create a datum using datum magic

##### Step 1

Click the *datum magic* button on the datum toolbar.



##### Step 2

Measure three points on the plane as shown.

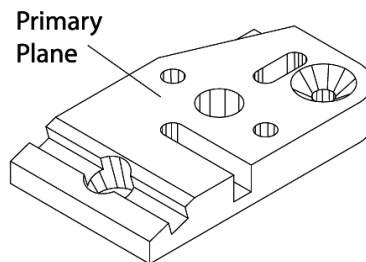

##### Step 3

Click OK in the dialog box.



## Chapter 5 Advanced Measuring & Output

Step 4

Probe two points on the secondary line as shown.

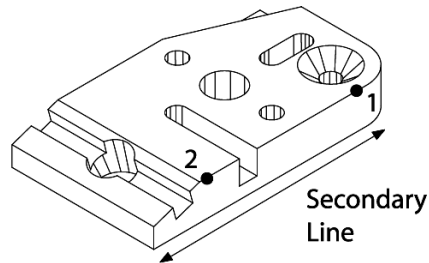

Step 5

Click OK in the dialog box.



Step 6

Probe two points on the tertiary alignment as shown.

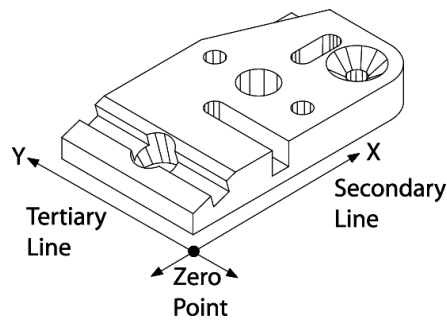

Step 7

Click OK in the dialog box.





## Measure Magic

Measure magic is an automated tool designed to help the user measure features. Activate measure magic by probing a feature. Click OK in the measure magic dialog box to complete the measurement. The new feature will appear in the part view window and on the features list. Use measure magic to measure the following types of features: points, lines, arcs, circles, planes, cones, cylinders, spheres. Measure magic cannot measure slots, distances, or angles.

### To measure a point using measure magic

#### Step 1

Probe the point as shown.

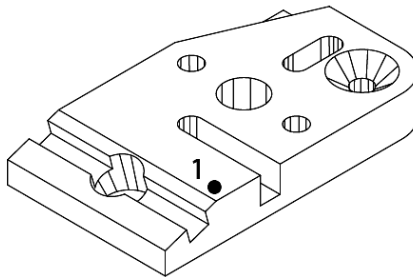

#### Step 2

Click OK in the dialog box.

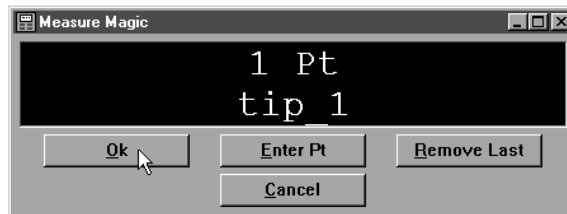

## Chapter 5 Advanced Measuring & Output

### To measure a line using measure magic (2 points)

Step 1

Probe two points on the line as shown.

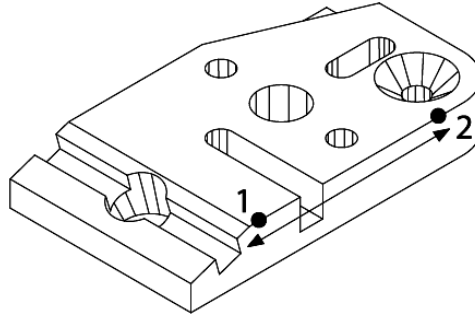

Step 2

Click OK in the dialog box.



### To measure an arc using measure magic (3 points)

Step 1

Probe three points on the arc as shown.

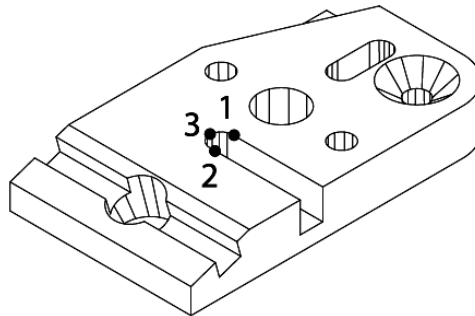

Step 2

Click OK in the dialog box.



**To measure a circle using measure magic (3 points)**

Step 1  
Probe three points on the circle as shown.

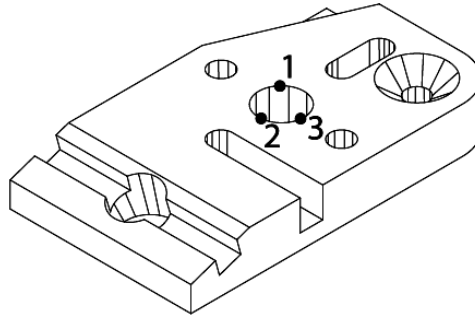

Step 2  
Click OK in the dialog box.



**To measure a plane using measure magic (3 points)**

Step 1  
Probe three points on the plane as shown.

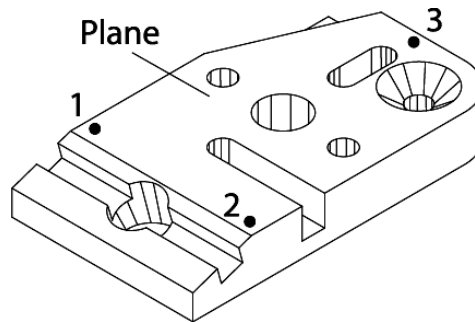

Step 2  
Click OK in the dialog box.



## Chapter 5 Advanced Measuring & Output

### To measure a cone using measure magic (6 points)

Step 1

Probe six points on the cone as shown.

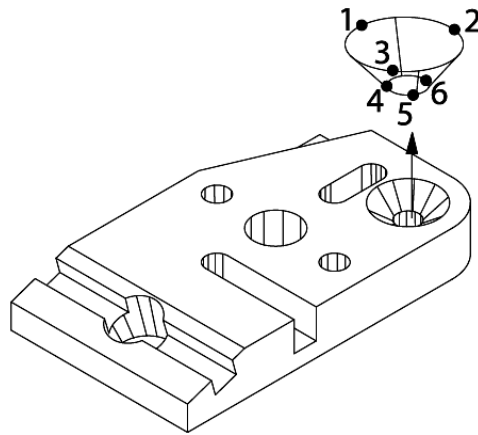

Step 2

Click OK in the dialog box.



**To measure a cylinder using measure magic (6 points)**

Step 1

Probe six points on the cylinder as shown.

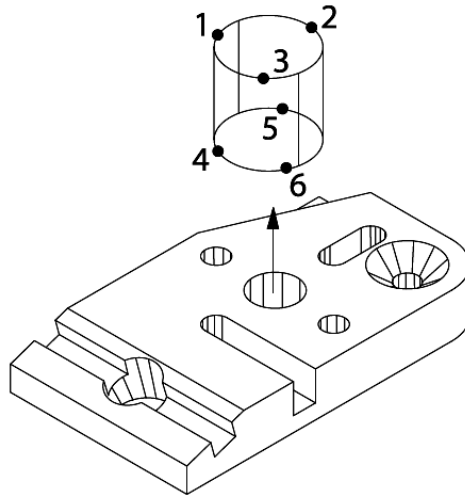

Step 2

Click OK in the dialog box.



## Chapter 5 Advanced Measuring & Output

### To measure a sphere using measure magic (4 points)

Step 1

Probe four points on the sphere as shown.

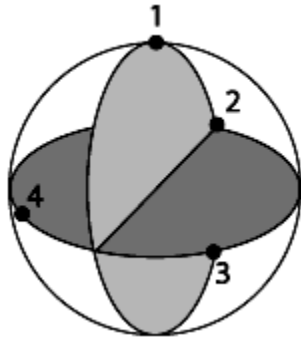

Step 2

Click OK in the dialog box.



## Layers

The part view window is made up of layers similar to a CAD drawing. Each layer contains features and can be displayed alone or with other layers. This allows the user to sort features into related groups and assign them to one layer. Layers can be hidden from view, turned on/off, and assigned colors.

Assign features that are related or likely to be viewed together to the same layer. This allows features to be selected as layer instead of selecting each feature individually.

### NOTE

**The features in the following procedures are for demonstration purposes only. These procedures will work with any features you choose.**

#### To create a new layer

##### Step 1

Select *layer control* from the view menu.

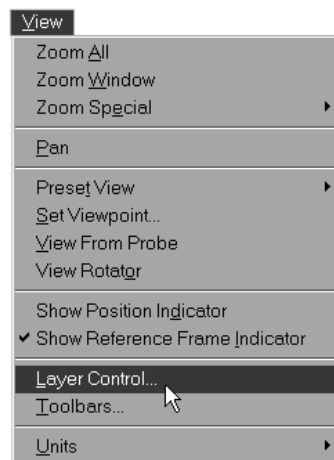

##### Step 2

Click the *new* button in the dialog box.

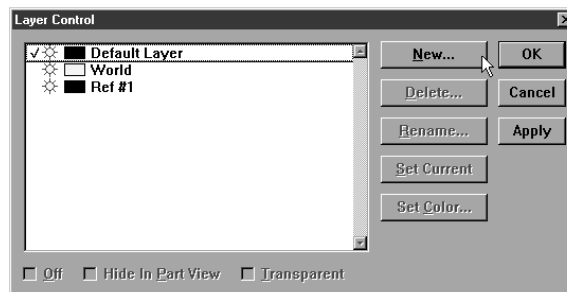

Step 3

Type the desired name of the new layer in the text box and click OK.



**NOTE**

This demonstration uses layers named as follows:

- Primary Layer
- Cylinders
- Distances

Create these layers to follow along with this demonstration.

**Current Layer**

All new features are assigned to the current layer.

**To set a layer as current**

Step 1

Select *layer control* from the view menu.



Step 2

Highlight the desired layer as shown.

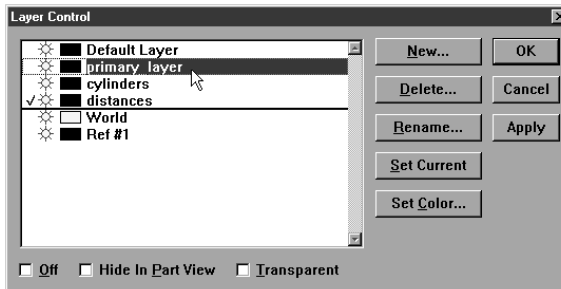



Step 3

Click the *set current* button. A checkmark indicates that the layer is now the current layer.

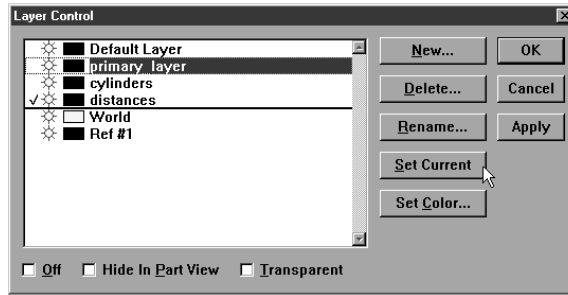

Step 4

Click OK in the dialog box.

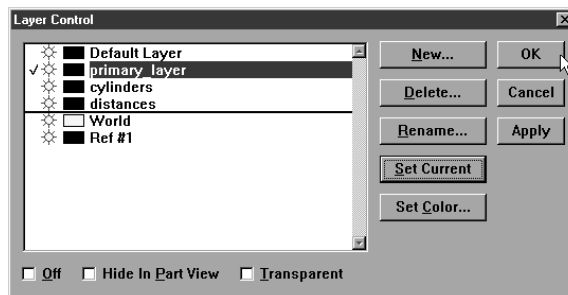

To assign features to new layers

Step 1

Select the desired features from the features list.

Name	Datum	X	Y	Z	d	r
Plane 1	Primary	3.21868	1.62520	0.00000		
Line 2	Skew	0.00000	1.49036	-0.39204		
Line 3		2.17580	-0.00110	-0.39047		
Point 4	Zero	0.00000	0.00000	-0.39125		
Cylinder		3.00304	1.54838	-0.19314	0.75196	0.3755
Cone 12		4.48106	0.75825	-0.57692		0.2065
Slot 13		4.31398	1.51320	-0.05594	0.37630	0.1881
Line 14		1.79343	0.82693	-0.04518		
Line 16		2.16950	0.81308	-0.04561		
Arc 18		2.00142	1.57309	-0.09430	0.37594	0.1875
Plane 19		2.83072	0.06706	-0.14923		



**NOTE**  
Hold down the ctrl key to make multiple selections.

Step 2

Right click and select *features properties* from the list.

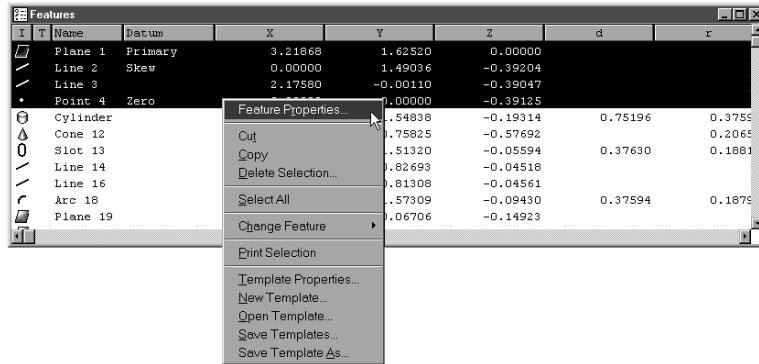

Step 3

Select the desired layer from the layers pull down list.

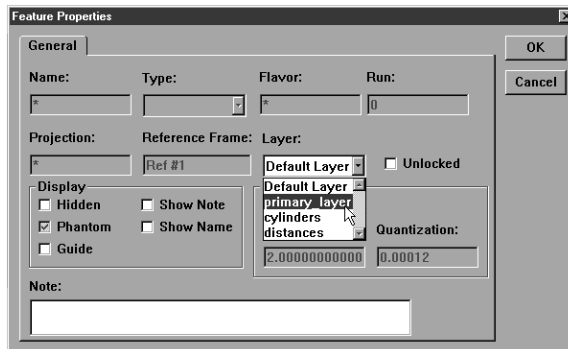

Step 4  
Click OK in the dialog box.

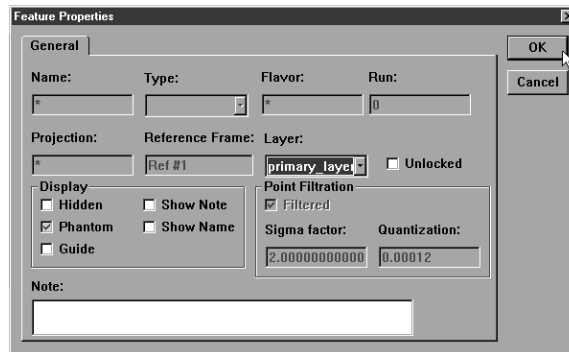

## Chapter 5 Advanced Measuring & Output

### Displaying Layers

Hiding a layer allows the user to remove a layer (and its features) from the part view window. This allows other layers to be viewed without additional features cluttering the part view. Hidden features remain in the features list even though they are not visible in the part view window.

#### To hide a layer

##### Step 1

Select *layer control* from the view menu.

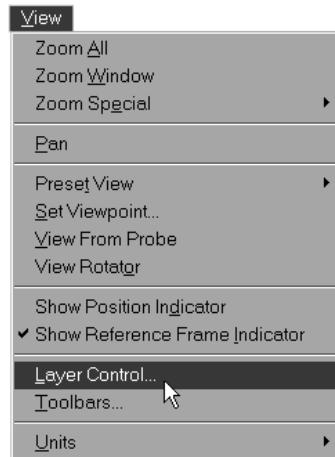

##### Step 2

Highlight the desired layer as shown.

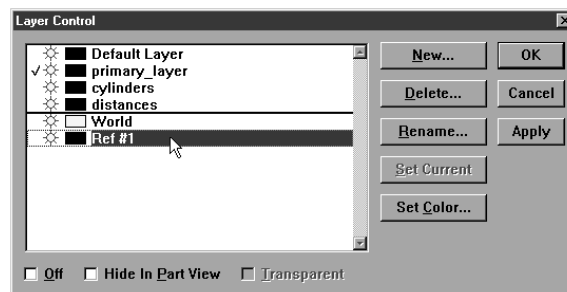

##### Step 3

Check the *hide in part view* box as shown.

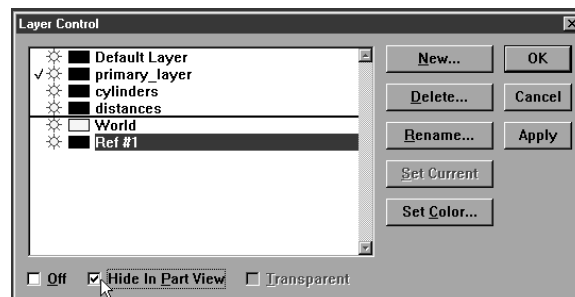

Step 4  
Click OK in the dialog box.

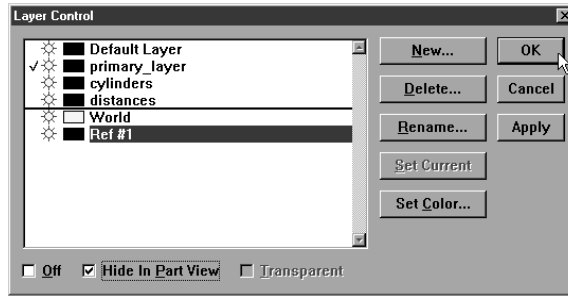

**To show a hidden layer**

Step 1  
Select *layer control* from the view menu.



Step 2  
Highlight the desired layer as shown.

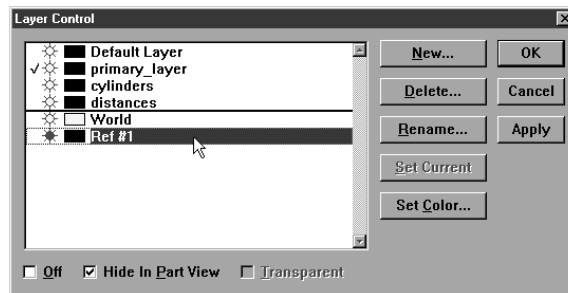

## Chapter 5 Advanced Measuring & Output

### Step 3

Uncheck the *hide in part view* box as shown.

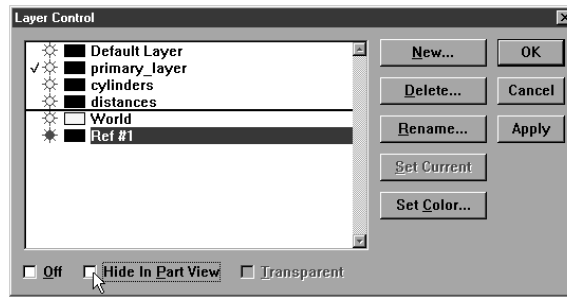

### Step 4

Click OK in the dialog box.

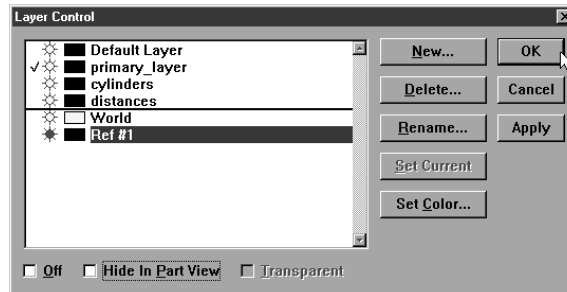

Turning a layer off completely removes the layer (and its features) the the part view window and the part file itself. Features onlayers that are off are no longer displayed in the features list. Turn the layer on to restore the features to the features list and the part file.

### To turn off a layer

**Step 1**

Select *layer control* from the view menu.



**Step 2**

Highlight the desired layer as shown.

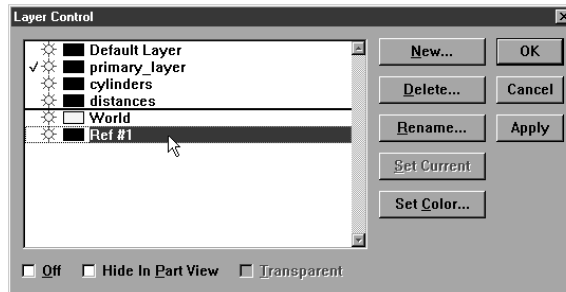

**Step 3**

Check the *off* box as shown

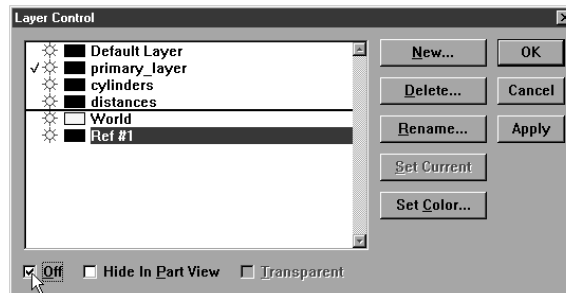

## Chapter 5 Advanced Measuring & Output

---

Step 4  
Click OK in the dialog box.

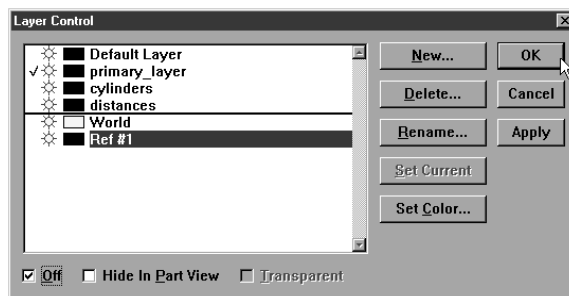



### To turn on a layer

**Step 1**

Select *layer control* from the view menu.



**Step 2**

Highlight the desired layer as shown.

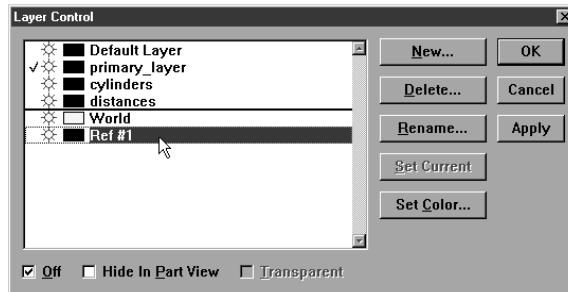

**Step 3**

Uncheck the *off* box as shown.

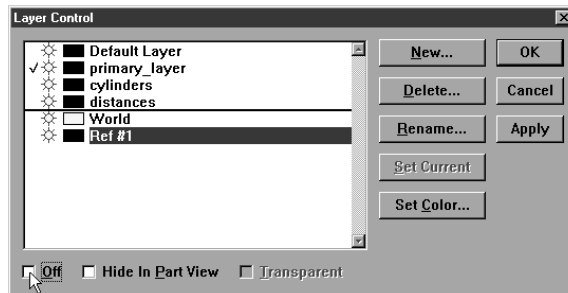

## Chapter 5 Advanced Measuring & Output

---

Step 4  
Click OK in the dialog box.

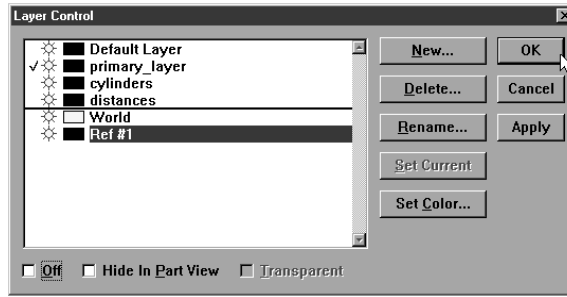

Assign colors to distinguish layers from one another. For example, features used to construct the reference frame can be assigned to a layer. This layer can be assigned the color black. All features of this layer appear black in the part view window.

**To assign a color to a layer**

**Step 1**

Select *layer control* from the view menu.



**Step 2**

Highlight the desired layer as shown.

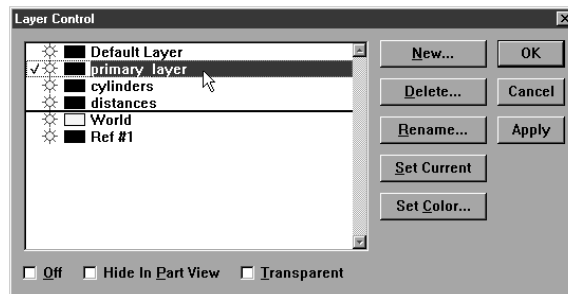

**Step 3**

Click the *set color* button.

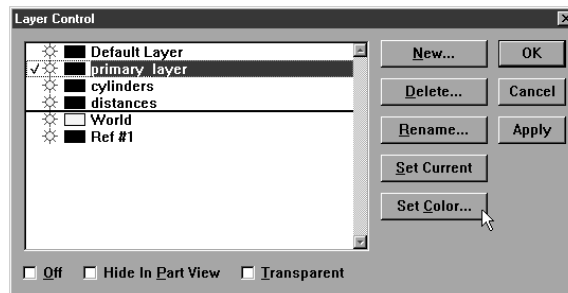

## Chapter 5 Advanced Measuring & Output

Step 3  
Select the desired color.

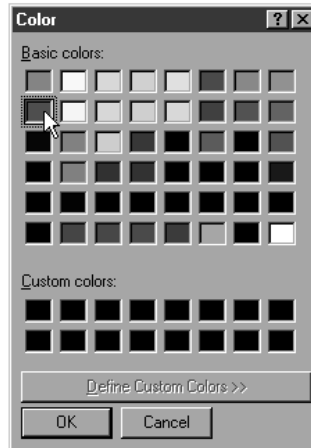

Step 4  
Click OK.

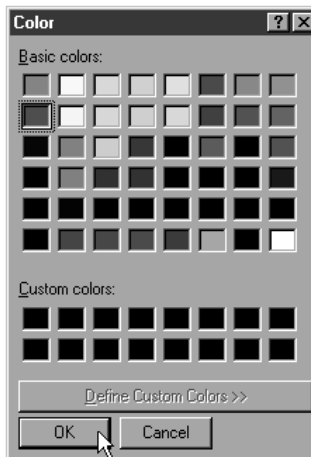

Step 5  
Click *apply*.

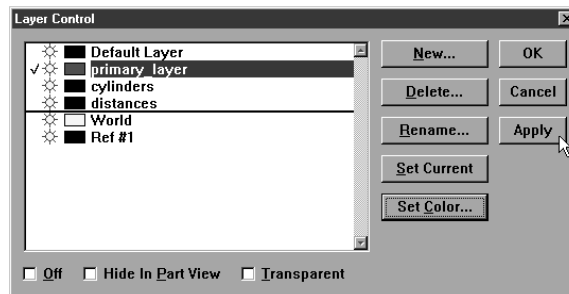

Step 6  
Click OK.

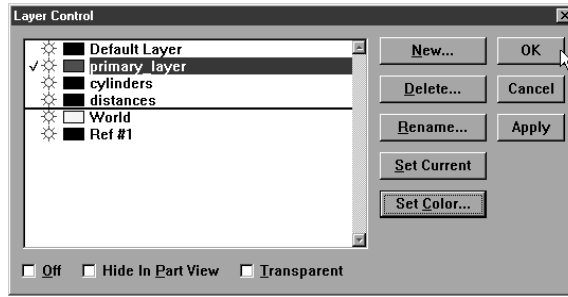

Alternate Datums

Use the rotate function to rotate the current reference frame. Note the position of the reference frame indicator (RFI) in the part view window. Its relationship to the measured part changes after rotation.

To rotate the reference frame (datum)

Step 1

Select *rotate* from the datum menu.

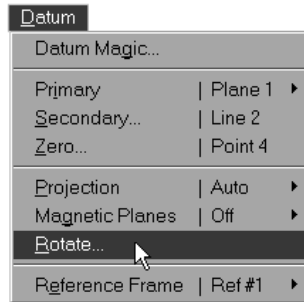

Step 2

Select the axis the reference frame will rotate around as shown.

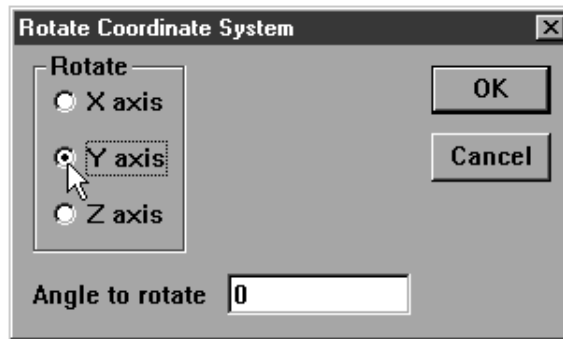

Step 3

Enter the amount of rotation in degrees.

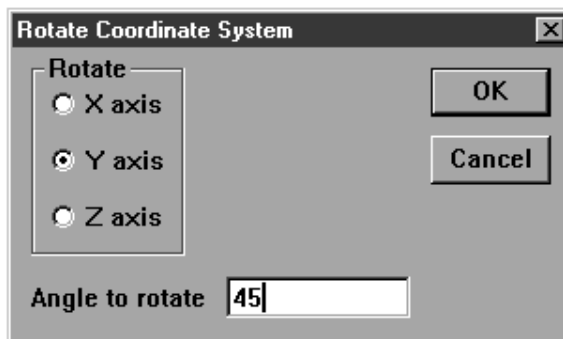

Step 4  
Click OK in the dialog box.

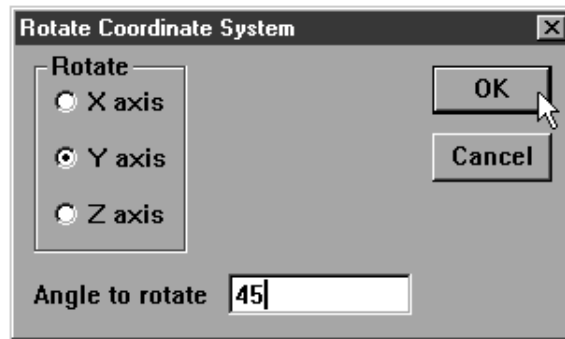

Offset Alignments

Offset alignments require the nominal location of three points. Use non-projected (projection plane is indicated as 3d or off) positional features.

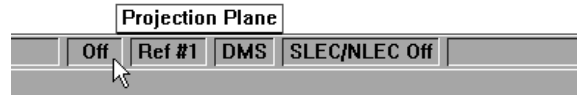

For example, the nominal center points of three positional features is acceptable.

To perform an offset alignment (primary plane)



NOTE

It may be simpler to delete all other features from the features list before beginning the offset alignment. This is optional and is NOT required.

Step 1

Click the *primary plane* button on the datum toolbar.



Step 2

Click on *create*.

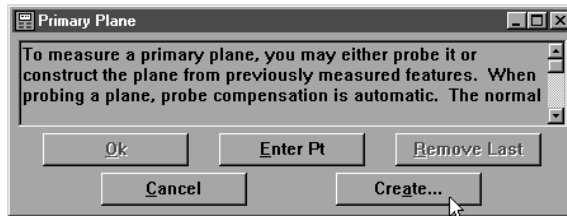

Step 3

Select the *offset* tab.

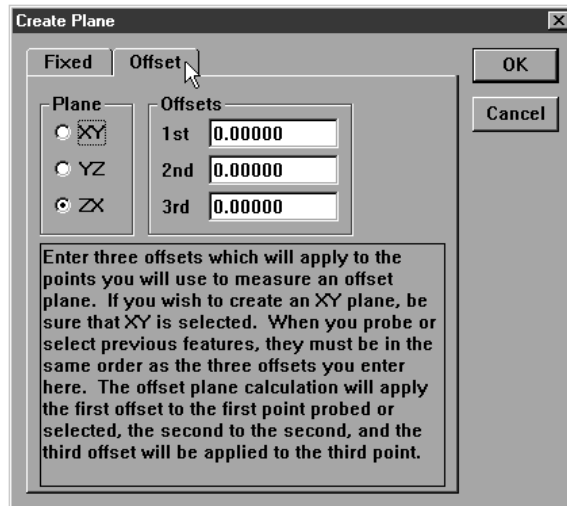



Step 4

Select the desired plane (XY, YZ, ZX) as shown.

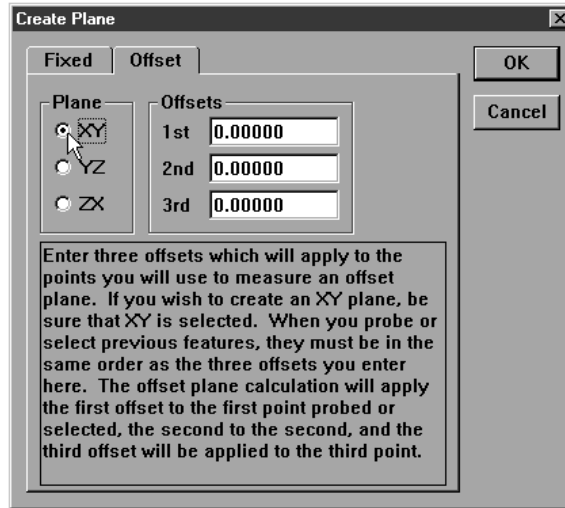

Step 5

Enter the offset value for each of the features as shown.

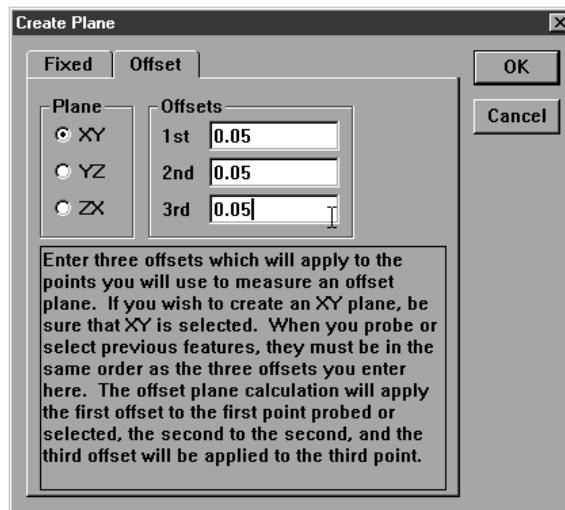

## Chapter 5 Advanced Measuring & Output

Step 6  
Click OK in the dialog box.

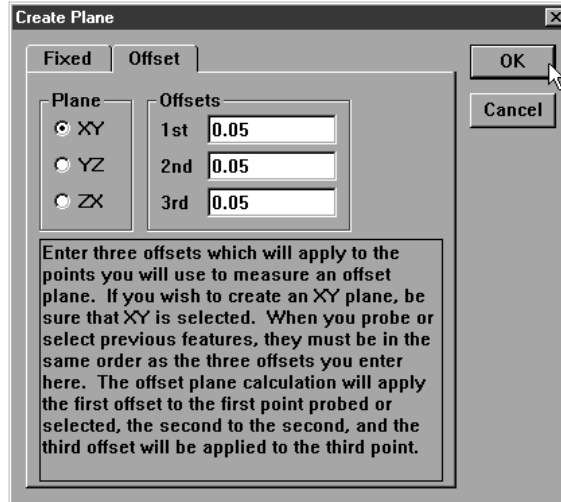

Step 7  
Highlight the three points (features) in the features list.

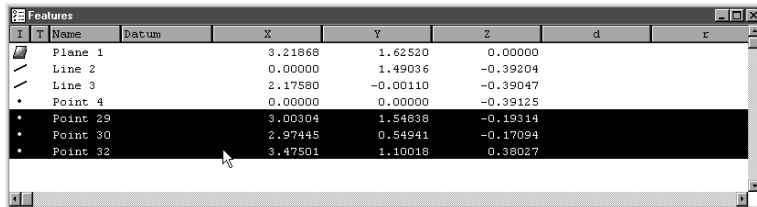

Step 8  
Click OK in the measure offset plane dialog box.

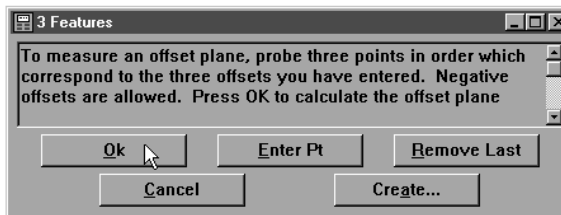

**To perform an offset alignment (secondary line)**

Step 1

Click the secondary line button on the datum toolbar.

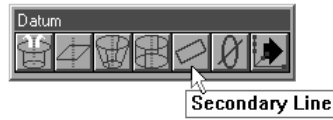

Step 2

Click on create.

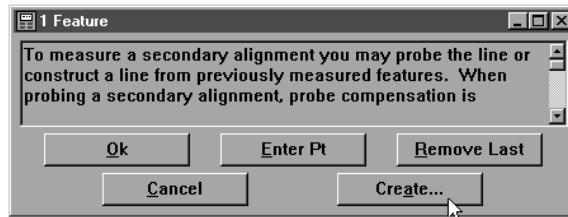

Step 3

Select the offset tab.

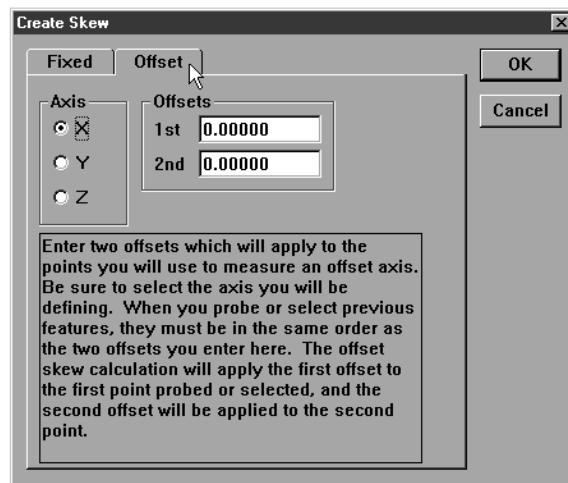

Step 4  
Set the axis as shown.

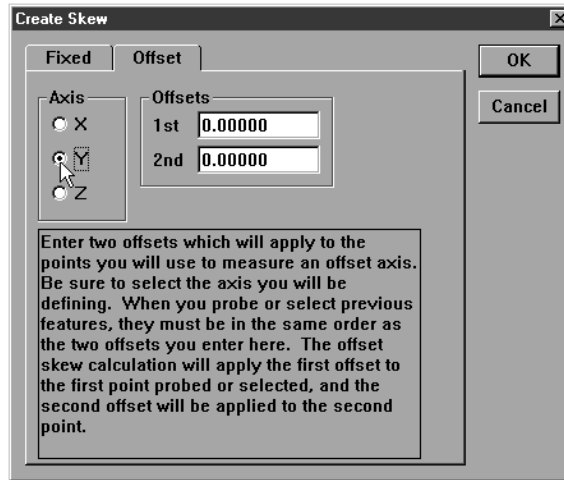

Step 5  
Enter the nominal values for two of the points (features).

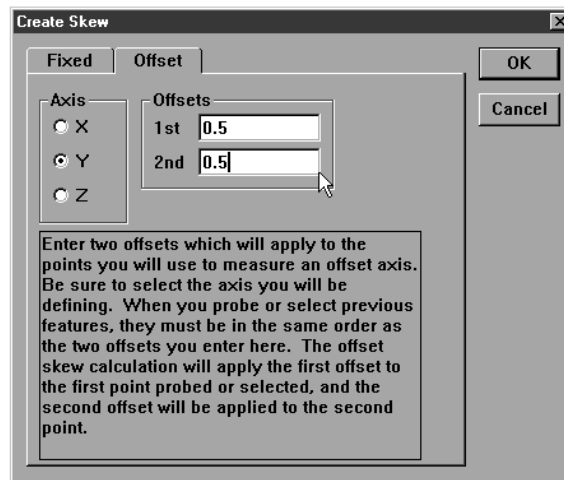

 **NOTE**

Use the nominal values for the axis that is NOT the skew. For example, if the skew is the X axis enter the Y nominal.

Step 6  
Click OK in the dialog box.

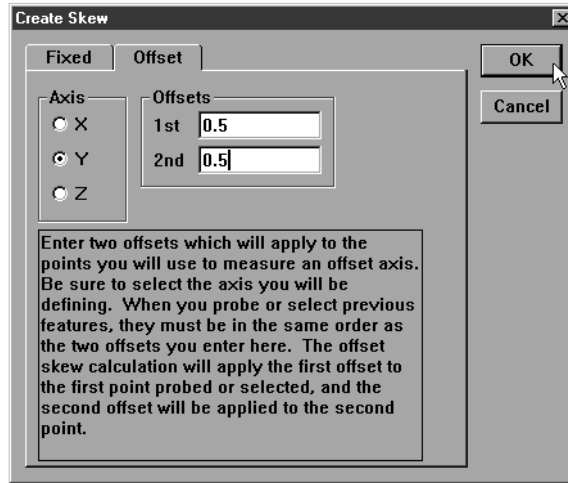

Step 7  
Highlight the skew points (entered in Step 4) in the features list.

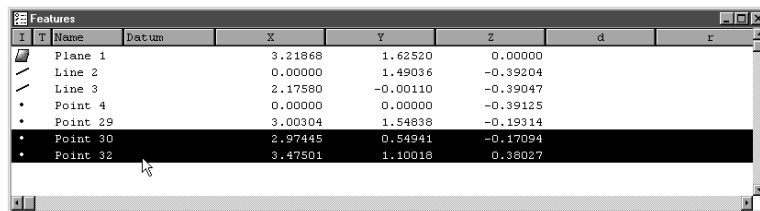

Step 8  
Click OK in the secondary line dialog box.

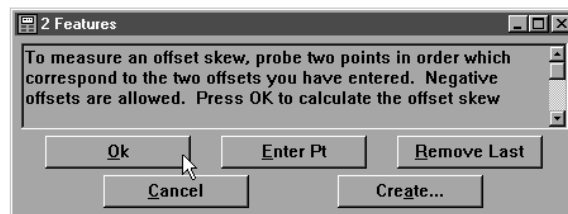

To perform an offset alignment (zero point)

Step 1

Click the *zero point* button on the datum toolbar.

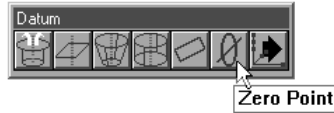

Step 2

Highlight one of the three original points (features) in the features list.

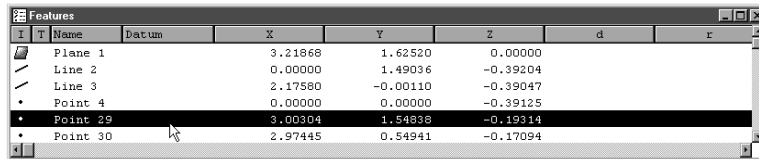

Step 3

Check the axis to be zeroed as shown.

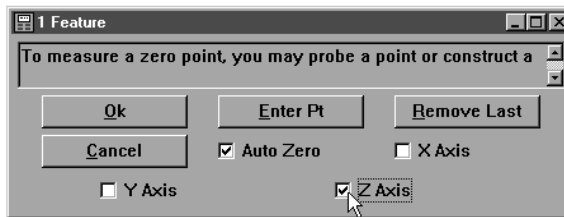

**NOTE**

Check the axis used as the skew in (secondary line) Step 4. For example, if you input Y nominals in (secondary line) Step 4, check the X axis.

Step 4

Click OK in the dialog box.

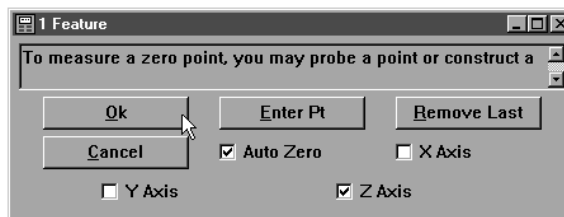

Step 5

Click the *point* button on the measure toolbar.



Step 6  
Click the *create* button.

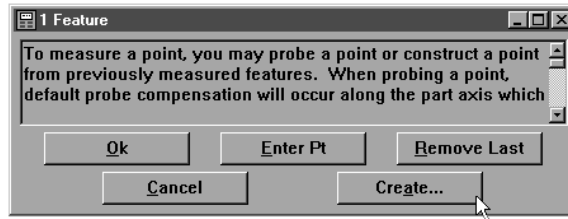

Step 7  
Click OK in the dialog box.

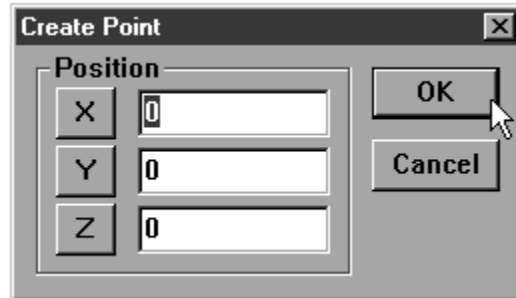

Step 8  
Click the *zero* button on the datum toolbar.



Step 9  
Highlight the point created in Step 6.

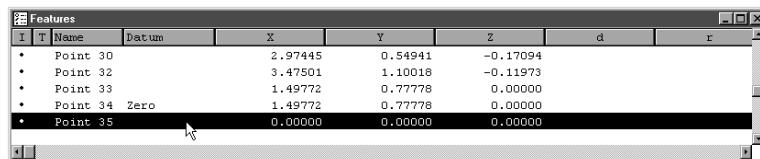

Step 10  
Click OK in the dialog box.

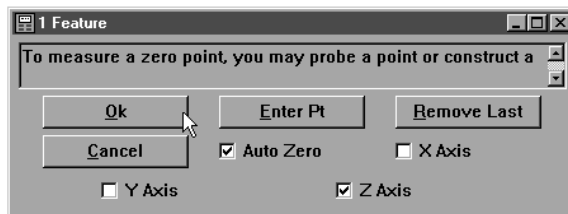

## Tolerancing

Tolerance is the acceptable amount of deviation from the perfect, or nominal, values of a part. For example, a bi-directional tolerance states how much (+ or -) the location of a feature may deviate from its nominal location. Use the tolerancing function to calculate positions, orientations, and bonuses to keep tolerancing simple and manageable. It is not even necessary to thoroughly understand tolerancing to successfully use it with the QC5000.

### Tolerance Toolbar



Use the tolerance toolbar to activate any of the 12 tolerance functions supported by the QC5000.

### NOTE

**Tolerance is feature dependent. This means that only certain tolerance functions apply to certain features. For example, a cylindricity tolerance cannot be performed on a point.**

### To view the tolerance toolbar

Step 1

Select *toolbars* from the view menu.





Step 2  
Highlight tolerance as shown.

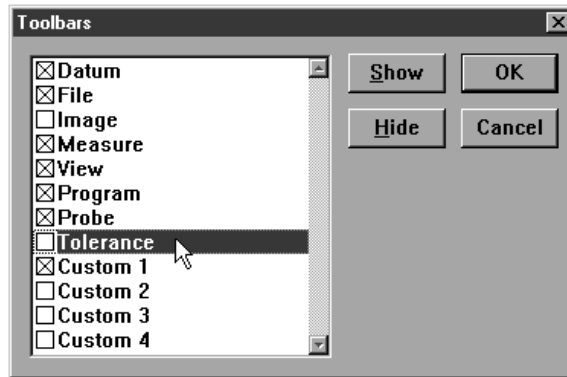

Step 3  
Click the *show* button. An 'X' appears next to tolerance.

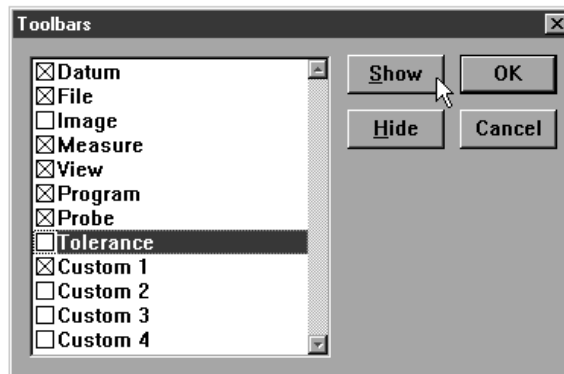

Step 4  
Click OK in the dialog box.

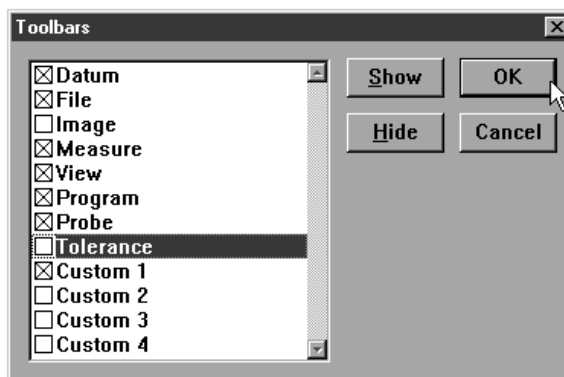

**Bi-directional tolerance (circles, points, arcs, spheres)**

Use bi-directional tolerance to specify nominal position and size for a selected feature, specify upper and lower deviation allowed from nominal position and size, and calculate pass/fail results. Bi-directional tolerance compares the measured location of a center point (on at least one axis) to the nominal location of that feature's center point.

**To perform a bi-directional tolerance**

Step 1

Highlight the desired feature in the features list.

I	T	Name	Datum	X	Y	Z	d	r
*		Point 4	Zero	0.00000	0.00000	-0.32781		
		Cylinder		2.98345	1.47448	-0.22281	0.75133	0.3756
		Circle 6		2.98822	2.47395	-0.02521	0.37471	0.1875
		Circle 7		2.97902	0.47526	0.00343	0.37796	0.1885
		Cone 8		4.48092	0.71760	-0.57746		0.1997
		Slot 9		4.29664	1.46776	-0.10389	0.37576	0.1876
		Plane 10		5.23194	1.37758	-0.25282		
		Plane 11		3.29730	-0.00788	-0.17703		
		Plane 12		4.25071	2.51275	-0.18908		
		Plane 13		2.20031	2.97443	-0.23446		
		Plane 14		0.64736	1.47401	-0.16478		
		Arc 15		4.48262	0.71749	-0.01184	1.49333	0.7460
		Line 16		2.16830	0.73663	-0.02645		



**NOTE**  
Use only a circle, point, arc, or sphere. Bi-directional tolerances do not apply to other types of features.

Step 2

Click the *bi-directional* button on the tolerance toolbar.



Step 3

Type the nominal X and Y values for your part in the boxes as shown.

Bi-Directional Tolerance Entry			
Position			
	Nominal	Nom -	Nom +
X	3.0	0.006	0.006
Y	2.5	0.006	0.006
Z	-0.02521		
Size			
	Nominal	Nom -	Nom +
R	0.1875	0.006	0.006

Step 4

Type in the nominal + and nominal - values for your feature as shown.

Position			
	Nominal	Nom -	Nom +
X	3.0	0.006	0.006
Y	2.5	0.006	0.006
Z	-0.02521		

Size			
	Nominal	Nom -	Nom +
R	0.1875	0.006	0.006

NOTE

Nominal + and - values are the same as the tolerance value for the feature. For example, if a feature has a tolerance of + or - 0.006 inches then the nominal + and nominal - values are 0.006 inches.

CAUTION

Enter tolerance values in the appropriate units of measurement. For example, if you are measuring in metric (mm) enter tolerance data in metric (mm).

Step 5

Click OK in the dialog box.

## Chapter 5 Advanced Measuring & Output

The tolerance result window appears as shown.

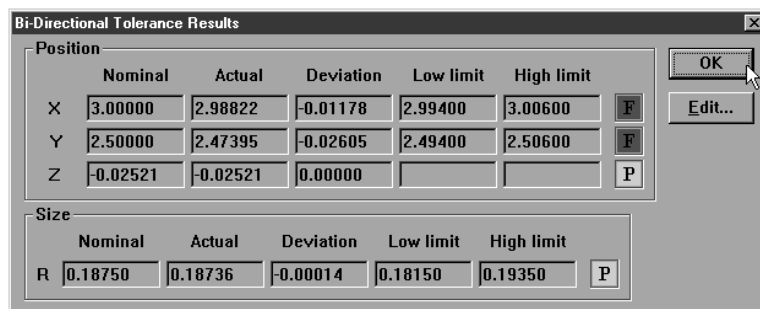

The image shows a software dialog box titled "Bi-Directional Tolerance Results". It contains two tables of data. The first table, labeled "Position", has columns for Nominal, Actual, Deviation, Low limit, and High limit, with rows for X, Y, and Z coordinates. The second table, labeled "Size", has columns for Nominal, Actual, Deviation, Low limit, and High limit, with a row for R. To the right of the tables are "OK" and "Edit..." buttons.

Bi-Directional Tolerance Results					
Position					
	Nominal	Actual	Deviation	Low limit	High limit
X	3.00000	2.98822	-0.01178	2.99400	3.00600
Y	2.50000	2.47395	-0.02605	2.49400	2.50600
Z	-0.02521	-0.02521	0.00000		

Size					
	Nominal	Actual	Deviation	Low limit	High limit
R	0.18750	0.18736	-0.00014	0.18150	0.19350

### Pass/ Fail Displays

A green pass symbol in the features list indicates the feature is within its tolerances.

I	T	Name	Datum	X	Y	Z	d	r
•		Point 4	Zero	0.00000	0.00000	-0.32781		
⊘		Cylinder		2.98345	1.47448	-0.22281	0.75133	0.3756
⊙		Circle 6		2.98822	2.47395	-0.02521	0.37471	0.1875
○		Circle 7		2.97902	0.47526	0.00343	0.37796	0.1885
△		Cone 8		4.48092	0.71760	-0.57746		0.1997

Red symbols indicate the feature failed one or more tolerances.

I	T	Name	Datum	X	Y	Z	d	r
•		Point 4	Zero	0.00000	0.00000	-0.32781		
⊘		Cylinder		2.98345	1.47448	-0.22281	0.75133	0.3756
⊙		Circle 6		2.98822	2.47395	-0.02521	0.37471	0.1875
○		Circle 7		2.97902	0.47526	0.00343	0.37796	0.1885

### True position tolerance (circles, points arcs, spheres)

Use true position tolerance to specify nominal position and size for a selected feature, specify upper and lower deviation allowed from nominal position and size, and calculate pass/fail results. True position tolerance compares the measured location of a center point (on at least one axis) to the nominal location of that feature's center point and separately compares the size of that feature. True position tolerancing is regardless of size tolerancing. This means that position and size are calculated independently and do produce true position bonuses.

### To perform a true position tolerance

#### Step 1

Highlight the desired feature in the features list.

I	T	Name	Datum	X	Y	Z	d	r
•		Point 4	Zero	0.00000	0.00000	-0.32781		
⊘		Cylinder		2.98345	1.47448	-0.22281	0.75133	0.3756
⊙		Circle 6		2.98822	2.47395	-0.02521	0.37471	0.1875
○		Circle 7		2.97902	0.47526	0.00343	0.37796	0.1885
△		Cone 8		4.48092	0.71760	-0.57746		0.1997
⊜		Slot 9		4.29664	1.46776	-0.10389	0.37576	0.1876
▱		Plane 10		5.23194	1.37758	-0.25282		
▱		Plane 11		3.29730	-0.00788	-0.17703		
▱		Plane 12		4.25071	2.51275	-0.18908		
▱		Plane 13		2.20031	2.97443	-0.23446		
▱		Plane 14		0.64736	1.47401	-0.16478		



**NOTE**  
Use only a circle, point, arc, or sphere. True position tolerances do not apply to other types of features.

#### Step 2

Click the *true position/MMC/LMC* button on the tolerance toolbar.

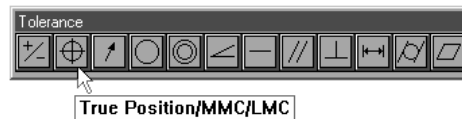

## Chapter 5 Advanced Measuring & Output

Step 3

Type the nominal X and Y values for your part in the boxes as shown.

The screenshot shows the 'True Position Tolerance Entry' dialog box. The 'Position' section is active, showing nominal values for X (3.0), Y (0.5), and Z (0.00343). The 'Tol. Dia.' field contains 0.006. The 'Size' section shows nominal values for R (0.1875), Nom - (0.006), and Nom + (0.006). Buttons for OK, Cancel, and Delete are visible on the right.

Position			
Nominal			
X	3.0	Tol. Dia.	
Y	0.5	0.006	
Z	0.00343		

Size			
	Nominal	Nom -	Nom +
R	0.1875	0.006	0.006

Step 4

Enter the specified diameter as shown.

This screenshot is identical to the previous one, showing the 'True Position Tolerance Entry' dialog box with the same values for Position and Size.

Step 5

Type in the nominal + and nominal - values for your feature as shown.

This screenshot is identical to the previous ones, showing the 'True Position Tolerance Entry' dialog box with the same values for Position and Size.

### NOTE

Nominal + and - values are the same as the tolerance value for the feature. For example, if a feature has a tolerance of + or - 0.006 inches then the nominal + and nominal - values are 0.006 inches.

**!** CAUTION

Enter tolerance values in the appropriate units of measurement. For example, if you are measuring in metric (mm) enter tolerance data in metric (mm).

Step 5  
Click OK in the dialog box.

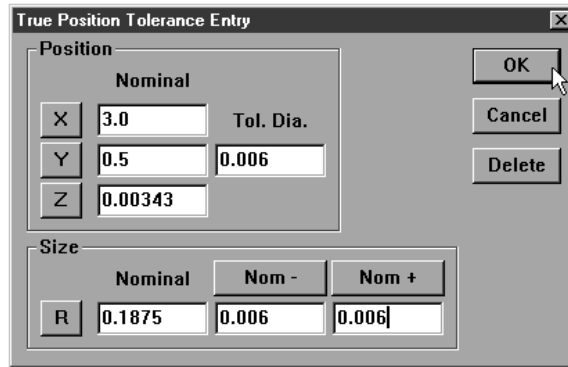

The tolerance results window appears as shown.

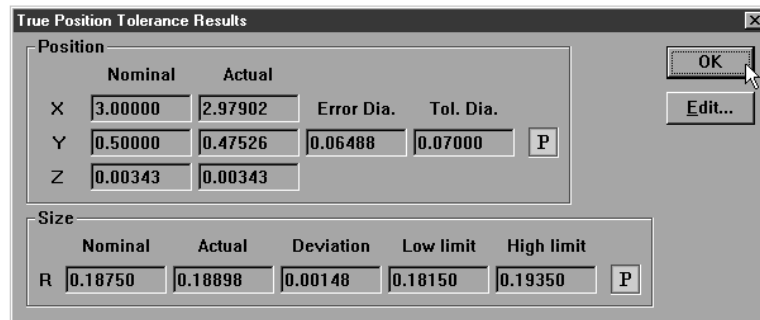

**↓** NOTE

Position and size may have a different pass/fail result from each other. A red fail marker will appear in the features list if either parameter fails.

**MMC/LMC (maximum material condition/least material condition) tolerance (circles, points arcs, spheres)**

Use MMC/LMC tolerances for bores and bosses to specify nominal X, Y, and Z positions for a selected feature, specify nominal diameter, specify nominal size, specify bore or boss setting, and calculate pass/fail results. MMC/LMC tolerancing factors true position bonus into its calculations.

**To perform a MMC tolerance**

Step 1

Highlight the desired feature in the features list.

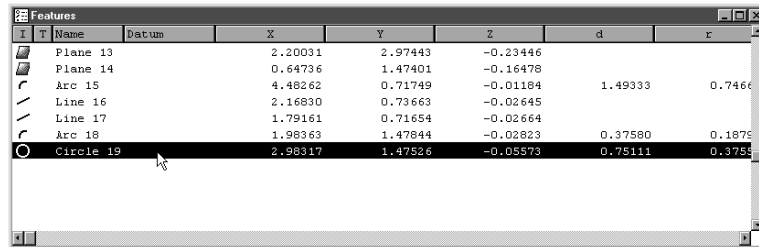

**Use only a circle, point, arc, or sphere. MMC tolerances do not apply to other types of features.**

Step 2

Select *tolerance* then *MMC* from the tools menu.

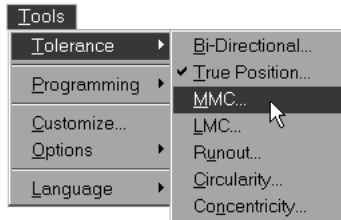

Step 3

Type the nominal X and Y values for your part in the boxes as shown.

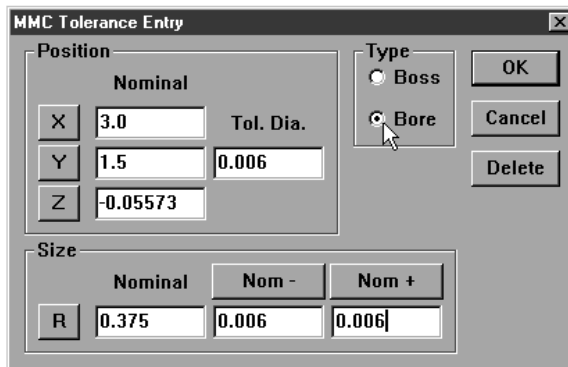



Step 4  
Enter the specified diameter as shown.

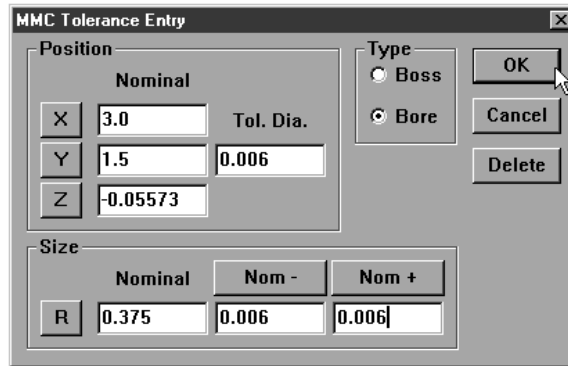

Step 5  
Type in the nominal + and nominal - values for your feature as shown.

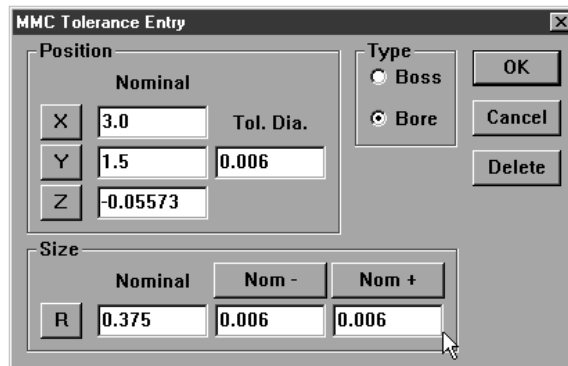

**NOTE**

Nominal + and - values are the same as the tolerance value for the feature. For example, if a feature has a tolerance of + or - 0.006 inches then the nominal + and nominal - values are 0.006 inches.

**CAUTION**

Enter tolerance values in the appropriate units of measurement. For example, if you are measuring in metric (mm) enter tolerance data in metric (mm).

## Chapter 5 Advanced Measuring & Output

Step 6  
Select *boss* or *bore* as shown.

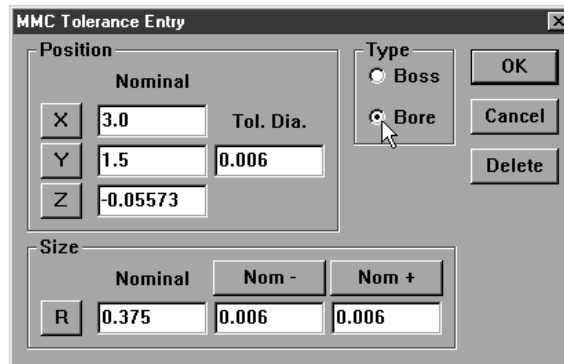

The dialog box is titled "MMC Tolerance Entry". It has a "Position" section with a "Nominal" column and a "Tol. Dia." column. The "Type" section has two radio buttons: "Boss" and "Bore", with "Bore" selected. There are "OK", "Cancel", and "Delete" buttons. The "Size" section has a "Nominal" column and two "Nom" columns: "Nom -" and "Nom +".

Position	
Nominal	Tol. Dia.
X	3.0
Y	1.5
Z	-0.05573

Type  
 Boss  
 Bore

Size

	Nominal	Nom -	Nom +
R	0.375	0.006	0.006

Step 7  
Click OK in the dialog box.

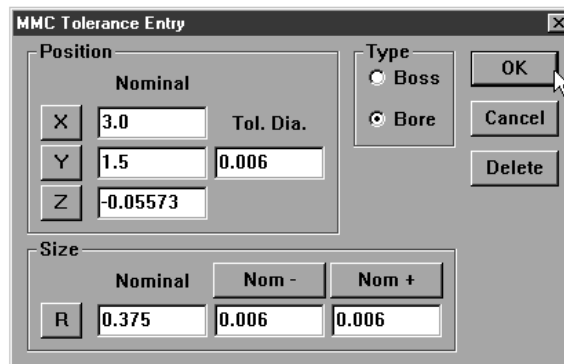

The dialog box is the same as in Step 6, but the "OK" button is highlighted with a mouse cursor.

The tolerance result window appears as shown.

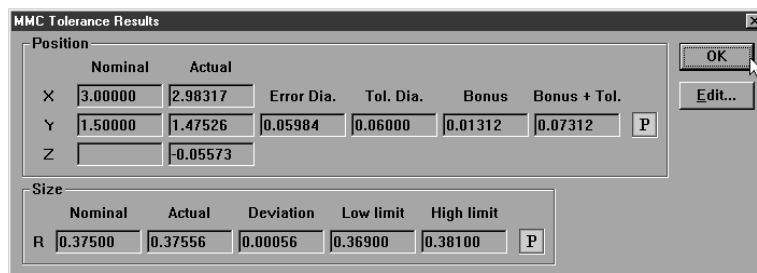

The dialog box is titled "MMC Tolerance Results". It has a "Position" section with columns for "Nominal", "Actual", "Error Dia.", "Tol. Dia.", "Bonus", and "Bonus + Tol.". The "Size" section has columns for "Nominal", "Actual", "Deviation", "Low limit", and "High limit". There are "OK" and "Edit..." buttons.

Position					
Nominal	Actual	Error Dia.	Tol. Dia.	Bonus	Bonus + Tol.
X	3.00000	2.98317			
Y	1.50000	1.47526	0.05984	0.06000	0.01312
Z		-0.05573			

Size

	Nominal	Actual	Deviation	Low limit	High limit
R	0.37500	0.37556	0.00056	0.36900	0.38100

**To perform a LMC**

**Step 1**

Highlight the desired feature in the features list.

I	T	Name	Datum	X	Y	Z	d	r
		Plane 13		2.20031	2.97443	-0.23446		
		Plane 14		0.64736	1.47401	-0.16478		
		Arc 15		4.48262	0.71749	-0.01184	1.49333	0.7466
		Line 16		2.16830	0.73663	-0.02645		
		Line 17		1.79161	0.71654	-0.02664		
		Arc 18		1.98363	1.47844	-0.02823	0.37580	0.1878
		Circle 20		2.98323	1.47509	-0.00851	0.75178	0.3758



**NOTE**

Use only a circle, point, arc, or sphere. MMC tolerances do not apply to other types of features.

**Step 2**

Select *tolerance* then *LMC* from the tools menu.

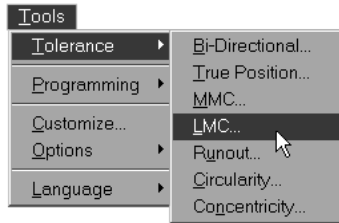

**Step 3**

Type the nominal X and Y values for your part in the boxes as shown.

**LMC Tolerance Entry**

**Position**

Nominal

X: 3.0 Tol. Dia. 0.06

Y: 1.5

Z: -0.00851

**Type**

Boss

Bore

OK

Cancel

Delete

**Size**

Nominal

R: 0.37589

Nom -

Nom +

## Chapter 5 Advanced Measuring & Output

Step 4

Enter the specified diameter as shown.

LMC Tolerance Entry

Position

Nominal

X 3.0 Tol. Dia. 0.06

Y 1.5

Z -0.00851

Type

Boss

Bore

OK

Cancel

Delete

Size

Nominal Nom - Nom +

R 0.375 0.006 0.006

Step 5

Type in the nominal + and nominal - values for your feature as shown.

LMC Tolerance Entry

Position

Nominal

X 3.0 Tol. Dia. 0.06

Y 1.5

Z -0.00851

Type

Boss

Bore

OK

Cancel

Delete

Size

Nominal Nom - Nom +

R 0.375 0.006 0.006

### NOTE

Nominal + and - values are the same as the tolerance value for the feature. For example, if a feature has a tolerance of + or - 0.006 inches then the nominal + and nominal - values are 0.006 inches.

### CAUTION

Enter tolerance values in the appropriate units of measurement. For example, if you are measuring in metric (mm) enter tolerance data in metric (mm).

Step 6  
 Select *boss* or *bore* as shown.

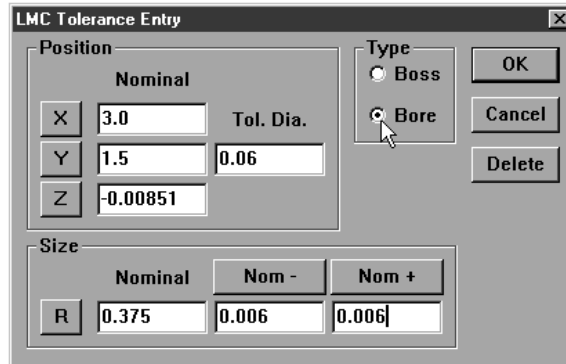

Step 7  
 Click OK in the dialog box.

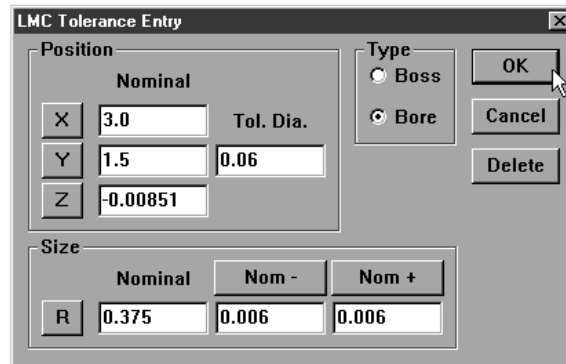

The tolerance results window appears as shown.

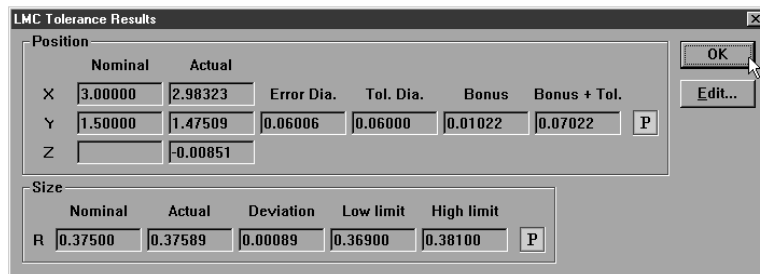

**Concentricity tolerance (circles, arcs)**

Use concentricity tolerancing to compare the measured position of a feature to the measured position of another concentric feature (reference feature). The measured position of the of the basis feature is the nominal of the feature being toleranced.

**To perform a concentricity tolerance**

Step 1

Highlight the desired feature in the features list.

I	T	Name	Datum	X	Y	Z	d	r
		Plane 14		0.64736	1.47401	-0.16478		
		Arc 15		4.48262	0.71749	-0.01184	1.49333	0.7466
		Line 16		2.16830	0.73663	-0.02645		
		Line 17		1.79161	0.71654	-0.02664		
		Arc 18		1.98363	1.47844	-0.02823	0.37580	0.1879
		Circle 20		2.98323	1.47509	-0.00851	0.75178	0.3758
		Circle 22		4.47870	0.71779	0.03316	1.02300	0.5115
		Circle 24		4.48052	0.71670	-0.37234	0.37391	0.1868

**NOTE**

Use only a circle or arc. Concentricity tolerances do not apply to other types of features.

Step 2

Click the *concentricity* button on the tolerance toolbar.



Step 3

Enter a value in the tolerance zone box as shown.

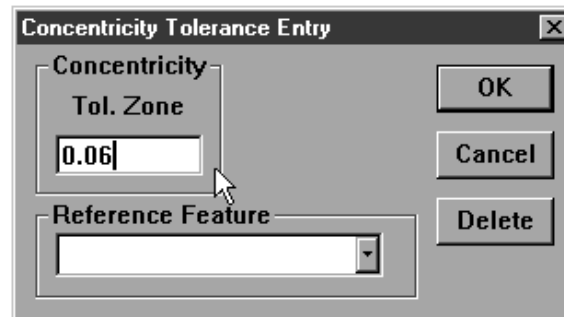

**NOTE**

The center point of the tolerance feature must lie within the tolerance zone to pass. The tolerance zone is defined by the diameter specified in the tolerance zone box. This is the tolerance value.

**!** CAUTION

Enter tolerance values in the appropriate units of measurement. For example, if you are measuring in metric (mm) enter tolerance data in metric (mm).

Step 4  
Select the reference feature as shown.

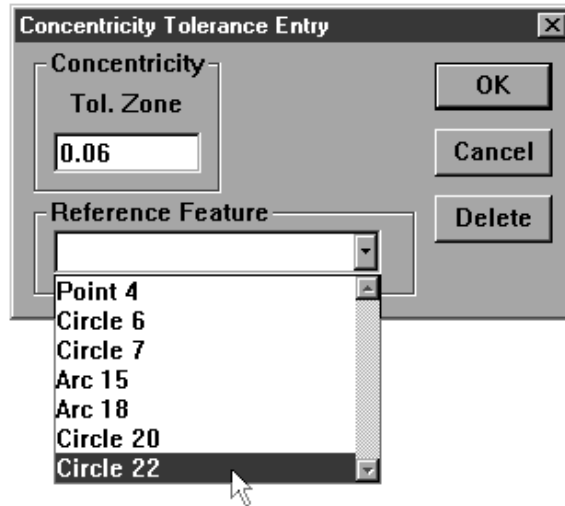

**↓** NOTE

If no features appear in the reference feature list concentricity tolerancing is not possible.

Step 5  
Click OK in the dialog box.

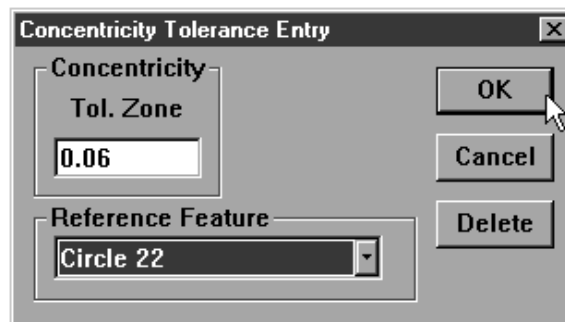

**Chapter 5    Advanced Measuring & Output**

---

The tolerance results window appears as shown.

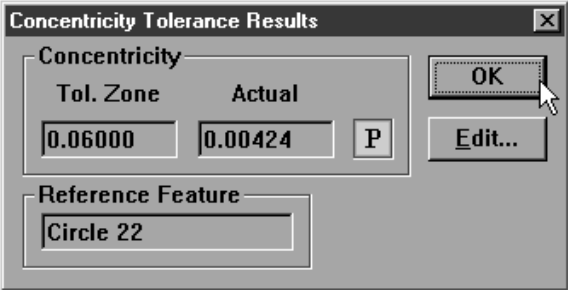



### Straightness tolerance (lines)

Use straightness tolerancing to calculate the straightness of a line and pass/fail results. Each point probed on a line is checked against the straightness tolerance. A minimum of three points distributed along the line are required (more points increase accuracy).

 **NOTE**

It is possible to perform a straightness tolerance on a line with only two points. This tolerance is meaningless because it is impossible for either point to be 'out' of the tolerance zone. Use a minimum of three points when performing a straightness tolerance.

### To perform a straightness tolerance (lines)

Step 1

Highlight the desired feature in the features list.

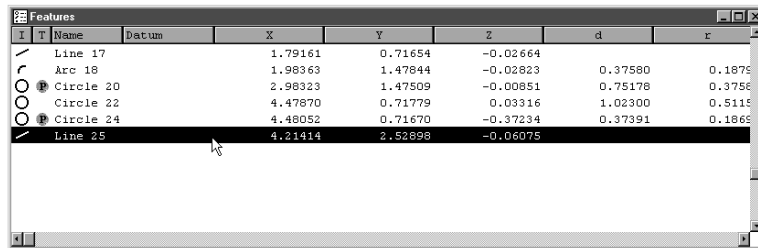

I	T	Name	Datum	X	Y	Z	d	r
✓		Line 17		1.79161	0.71654	-0.02664		
✓		Arc 18		1.98363	1.47844	-0.02823	0.37580	0.1875
○	○	Circle 20		2.98323	1.47509	-0.00851	0.75178	0.3758
○	○	Circle 22		4.47870	0.71779	0.03316	1.02300	0.5115
○	○	Circle 24		4.48052	0.71670	-0.37234	0.37391	0.1868
✓		Line 25		4.21414	2.52898	-0.06075		

 **NOTE**

Use a line only. Straightness tolerances do not apply to other types of features.

Step 2

Click the *straightness* button on the tolerance toolbar.

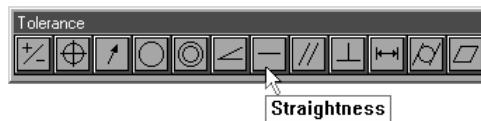

Step 3

Enter a value in the tolerance zone box as shown.

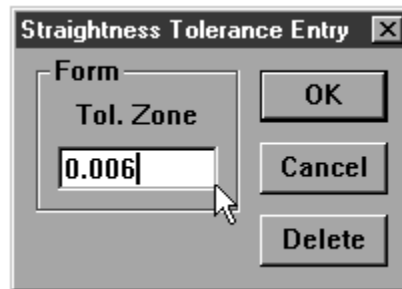

**Straightness Tolerance Entry**

Form

Tol. Zone

0.006

OK

Cancel

Delete

**!** CAUTION

Enter tolerance values in the appropriate units of measurement. For example, if you are measuring in metric (mm) enter tolerance data in metric (mm).

Step 4  
Click OK in the dialog box.



The tolerance results window appears as shown.

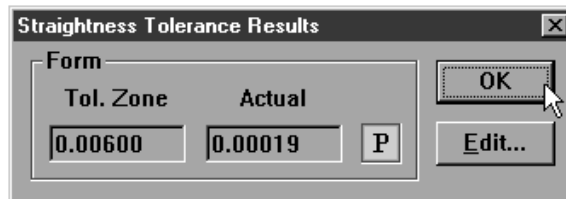

**Circularity/sphericity tolerance (circles, spheres)**

Use circularity/sphericity as form tolerance for circles and spheres. This tolerance defaults to circularity when the selected feature is a circle and sphericity when the selected feature is a sphere. A minimum of four points is required for a circularity tolerance and five points for a sphericity tolerance. The more points used in the tolerance the more accurate the final result.

**To perform a circularity tolerance**

**Step 1**

Highlight the desired feature in the features list.

I	T	Name	Datum	X	Y	Z	d	r
○		Circle 20		2.98323	1.47509	-0.00851	0.75178	0.3755
○		Circle 22		4.47870	0.71779	0.03316	1.02300	0.5115
○		Circle 24		4.48052	0.71670	-0.37234	0.37391	0.1865
○		Line 25		4.21414	2.52898	-0.06075		
○		Circle 26		5.75342	3.75782	-0.05241	0.75179	0.3755
○		Circle 27		7.31711	3.15484	0.01377	0.98428	0.4921
○		Circle 28		7.32008	3.15612	-0.38132	0.37426	0.187



**Use a circle only. Circularity tolerances do not apply to other types of features.**

**Step 2**

Click the *circularity/sphericity* button on the tolerance toolbar.



**Step 3**

Enter a value in the tolerance zone box as shown.



**Enter tolerance values in the appropriate units of measurement. For example, if you are measuring in metric (mm) enter tolerance data in metric (mm).**

## Chapter 5 Advanced Measuring & Output

---

Step 4  
Click OK in the dialog box.

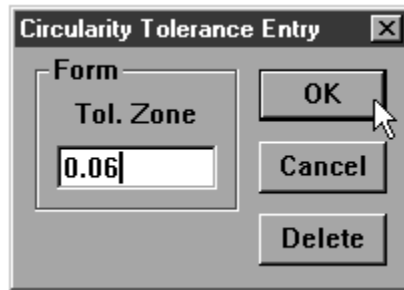

The tolerance results window appears as shown.

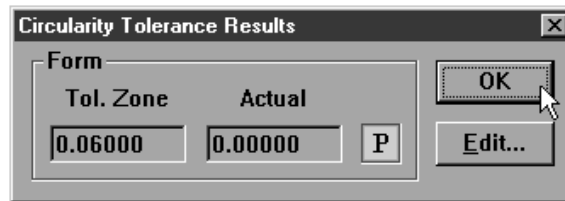

**To perform a sphericity tolerance**

Step 1

Highlight the desired feature in the features list.

ID	Name	Datum	X	Y	Z	d	r
20	Circle 20		2.98323	1.47509	-0.00851	0.75178	0.3755
22	Circle 22		4.47870	0.71779	0.03316	1.02300	0.5115
24	Circle 24		4.48052	0.71670	-0.37234	0.37391	0.1865
25	Line 25		4.21414	2.52898	-0.06075		
26	Circle 26		5.75342	3.75782	-0.05241	0.75179	0.3755
27	Circle 27		7.31711	3.15484	0.01377	0.98428	0.4821
28	Circle 28		7.32008	3.15812	-0.38132	0.37426	0.1871
29	Sphere 29		4.48000	0.71788	0.18807	1.00000	0.5000

**NOTE**

Use a circle only. Sphericity tolerances do not apply to other types of features.

Step 2

Click the *circularity/sphericity* button on the tolerance toolbar.

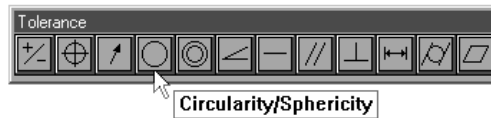

Step 3

Enter a value in the *tolerance zone* box as shown.

**CAUTION**

Enter tolerance values in the appropriate units of measurement. For example, if you are measuring in metric (mm) enter tolerance data in metric (mm).

Step 4

Click OK in the dialog box.

**Chapter 5    Advanced Measuring & Output**

---

The tolerance results window appears as shown.

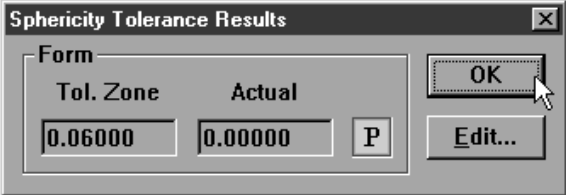

**Cylindricity tolerance (cylinders)**

Use cylindricity to compare the measured form of a cylinder to a specific tolerance zone and calculate pass/fail results. Cylinder measurement requires a minimum of six points. Enter additional points to increase the accuracy of your measurements.

**To perform a cylindricity tolerance**

Step 1

Highlight the desired feature in the features list.

I	T	Name	Datum	X	Y	Z	d	r
✓	⊕	Line 25		4.21414	2.52898	-0.06075		
○		Circle 26		5.75342	3.75782	-0.05241	0.75179	0.3755
○		Circle 27		7.31711	3.15484	0.01377	0.98428	0.4921
○	⊕	Circle 28		7.32008	3.15812	-0.38132	0.37426	0.1871
○	⊕	Sphere 29		4.48000	0.71786	0.18807	1.00000	0.5000
○		Circle 30		5.75060	3.75804	0.03074	0.78381	0.3915
⊕		Cylinder		5.75350	3.75831	-0.21500	0.75249	0.3762
○		circle 32		5.75441	3.75904	-0.01261	0.75167	0.3755



**NOTE**  
Use a cylinder only. Cylindricity tolerances do not apply to other types of features.

Step 2

Click the *cylindricity* button on the tolerance toolbar.



Step 3

Enter a value in the tolerance zone box as shown.

**Cylindricity Tolerance Entry**

Form

Tol. Zone

0.06

OK

Cancel

Delete



**CAUTION**  
Enter tolerance values in the appropriate units of measurement. For example, if you are measuring in metric (mm) enter tolerance data in metric (mm).

## Chapter 5 Advanced Measuring & Output

---

Step 4  
Click OK in the dialog box.

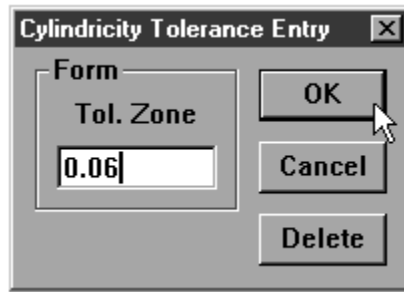

The tolerance results window appears as shown.

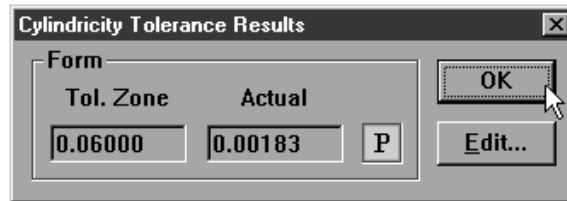



**Flatness tolerance (planes)**

Use flatness to specify form tolerance for planes. Flatness tolerances require a minimum of four points. Enter additional points to increase the accuracy of your measurements.

**To perform a flatness tolerance**

**Step 1**

Highlight the desired feature in the features list.

I	T	Name	Datum	X	Y	Z	d	r
		Plane 10		5.23194	1.37758	-0.25282		
		Plane 11		3.29730	-0.00788	-0.17703		
		Plane 12		4.25071	2.51275	-0.18908		
		Plane 13		2.20031	2.97443	-0.23446		
		Plane 14		0.64736	1.47401	-0.16478		
		Arc 15		4.48262	0.71749	-0.01184	1.49333	0.7466
		Line 16		2.16830	0.73663	-0.02645		
		Line 17		1.79161	0.71654	-0.02664		
		Arc 18		1.98363	1.47644	-0.02823	0.37580	0.1875
		Circle 20		2.98323	1.47509	-0.00851	0.75178	0.3758
		Circle 22		4.47870	0.71779	0.03316	1.02300	0.5115



**NOTE**  
Use a plane only. Flatness tolerances do not apply to other types of features.

**Step 2**

Click the *flatness* button on the tolerance toolbar.



**Step 3**

Enter a value in the tolerance zone box as shown.

Flatness Tolerance Entry

Form

Tol. Zone

0.06

OK

Cancel

Delete



**CAUTION**  
Enter tolerance values in the appropriate units of measurement. For example, if you are measuring in metric (mm) enter tolerance data in metric (mm).

## Chapter 5 Advanced Measuring & Output

---

Step 4  
Click OK in the dialog box.

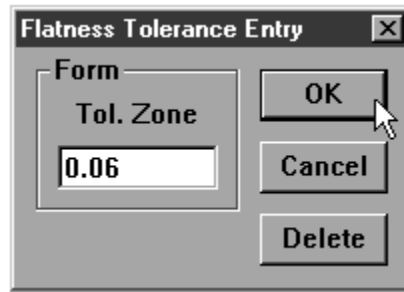

The tolerance result window appears as shown.

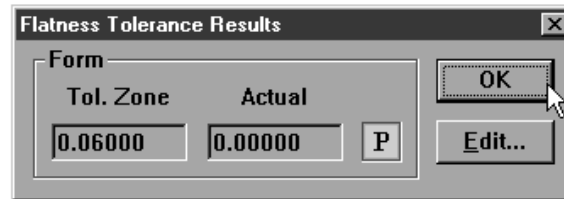

**Perpendicularity tolerance (lines, cylinders, cones)**

Use perpendicularity to establish an orientation tolerance between linear features. Perpendicularity tolerancing compares the axial orientation of the selected feature to the axis of a reference feature. The actual tolerance zone is a cylindrical area around the axis of the tolerance feature. Specify the diameter of the cylindrical tolerance zone to create the tolerance.

**To perform a perpendicularity tolerance**

**Step 1**

Highlight the desired feature in the features list.

I	T	Name	Datum	X	Y	Z	d	r
•		Point 4	Zero	0.00000	0.00000	-0.32781		
○		Cylinder		2.98345	1.47448	-0.22281	0.75133	0.3754
○		Circle 6		2.98822	2.47395	-0.02521	0.37471	0.1873
○		Circle 7		2.97902	0.47526	0.00343	0.37796	0.1885
△		Cone 8		4.48092	0.71760	-0.57746		0.1997
0		Slot 9		4.29664	1.46776	-0.10389	0.37576	0.1876
		Plane 10		5.23194	1.37758	-0.25282		
		Plane 11		3.29730	-0.00788	-0.17703		
		Plane 12		4.25071	2.51275	-0.18908		
		Plane 13		2.20031	2.97443	-0.23446		
		Plane 14		0.64736	1.47401	-0.16478		

**NOTE**

**Use a linear features only. Perpendicularity tolerances do not apply to other types of features.**

**Step 2**

Click the *perpendicularity* button on the tolerance toolbar.



**Step 3**

Enter a value in the tolerance zone box as shown.

**! CAUTION**

**Enter tolerance values in the appropriate units of measurement. For example, if you are measuring in metric (mm) enter tolerance data in metric (mm).**

## Chapter 5 Advanced Measuring & Output

Step 4

Select a reference feature from the pull down list.

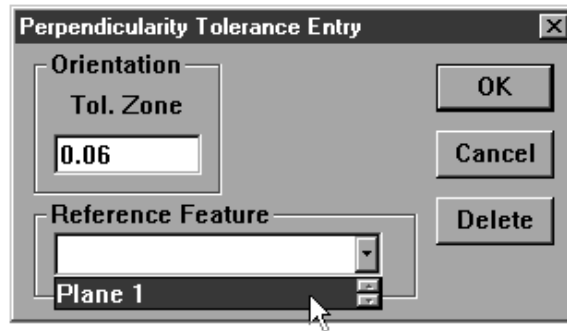

Step 5

Click OK in the dialog box.

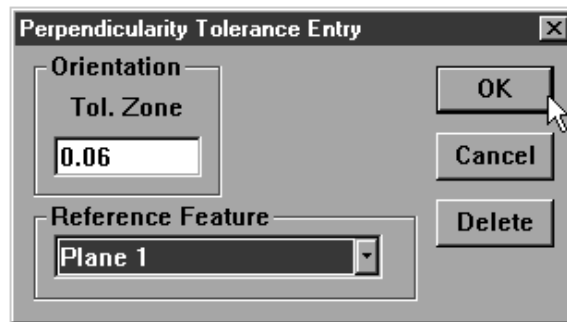

The tolerance result window appears as shown.

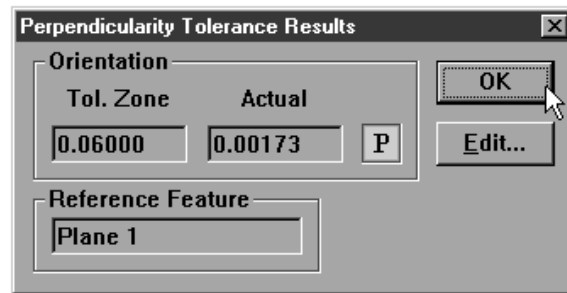

**Parallelism/Co-planarity tolerance (linear features)**

Use parallelism as an orientation tolerance for cylinders, cones, and lines. Parallelism tolerancing compares the axial orientation of the selected feature to the axis of a reference feature. The actual tolerance zone is a cylindrical area around the axis of the tolerance feature. Specify the diameter of the cylindrical tolerance zone to create the tolerance. tolerancing compares the orientation of the axis of the tolerated feature to a reference feature.

Use co-planarity as an orientation tolerance between planes. Two planes spaced evenly apart with the same orientation are said to be co-planar.

**To perform a parallelism tolerance**

**Step 1**

Highlight the desired feature in the features list.

Name	Datum	X	Y	Z	d	r
Plane 12		4.25071	2.51275	-0.18908		
Plane 13		2.20031	2.97443	-0.23446		
Plane 14		0.64736	1.47401	-0.16478		
Arc 15		4.48262	0.71749	-0.01184	1.49333	0.7466
Line 16		2.16830	0.73663	-0.02645		
<b>Line 17</b>		<b>1.79161</b>	<b>0.71654</b>	<b>-0.02664</b>		
Arc 18		1.98363	1.47844	-0.02823	0.37580	0.1875
Circle 20		2.98323	1.47509	-0.00851	0.75178	0.3755
Circle 22		4.47870	0.71779	0.03316	1.02300	0.5115
Circle 24		4.48052	0.71670	-0.37234	0.37391	0.1865
Line 25		4.21414	2.52898	-0.06075		

**NOTE**

**Use a linear features only. Parallelism tolerances do not apply to other types of features.**

**Step 2**

Click the *parallelism/co-planarity* button on the tolerance toolbar.



**Step 3**

Enter a value in the *tolerance zone* box as shown.

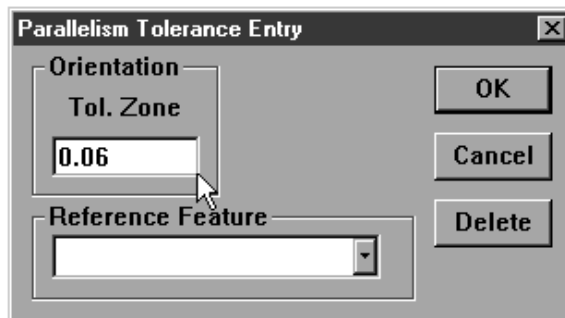

**CAUTION**

**Enter tolerance values in the appropriate units of measurement. For example, if you are measuring in metric (mm) enter tolerance data in metric (mm).**

Step 4  
Select a reference feature from the pull down list.

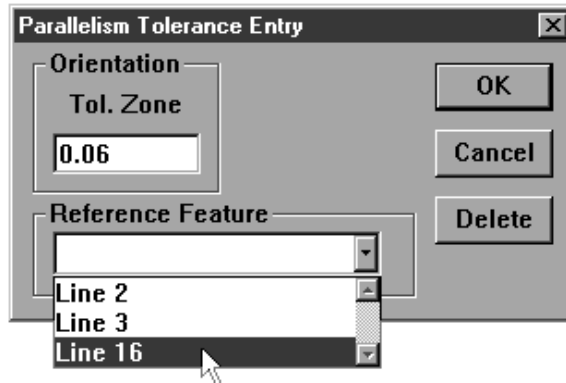

Step 5  
Click OK in the dialog box.

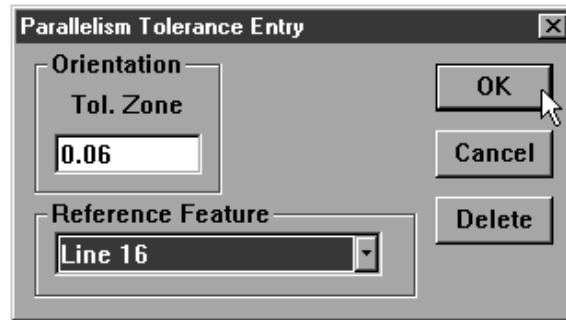

The tolerance results window appears as shown.

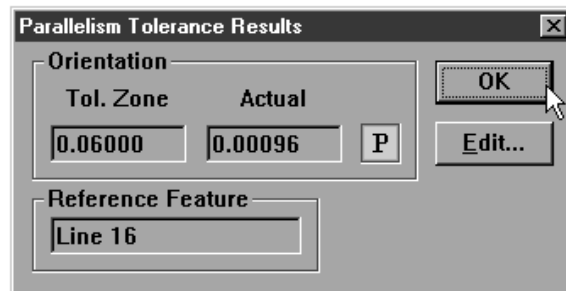

**To perform a co-planarity tolerance**

**Step 1**

Highlight the desired feature in the features list.

I	T	Name	Datum	X	Y	Z	d	r
○		Circle 28		7.32008	3.15812	-0.38132	0.37426	0.1871
○		Sphere 29		4.48000	0.71786	0.18807	1.00000	0.5000
○		Circle 30		5.75060	3.75804	0.03074	0.78381	0.3915
○		Cylinder		5.75350	3.75831	-0.21500	0.75249	0.3762
○		Circle 32		5.75441	3.75904	-0.01261	0.75167	0.3756
✓		Line 33		7.09668	3.70053	-0.00320		
✓		Line 34		7.09016	4.07377	-0.01127		

**NOTE**

Use a plane only. Co-planarity tolerances do not apply to other types of features.

**Step 2**

Click the *parallelism/co-planarity* button on the tolerance toolbar.

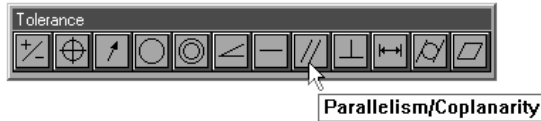

**Step 3**

Enter a value in the *tolerance zone* box as shown.

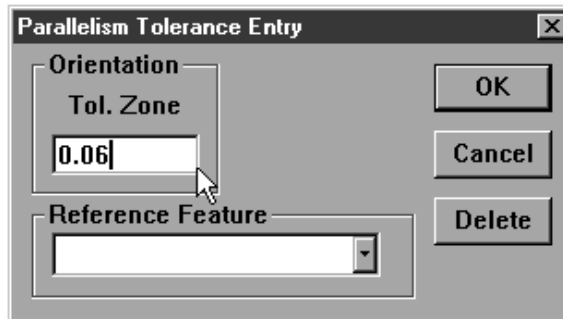

**CAUTION**

Enter tolerance values in the appropriate units of measurement. For example, if you are measuring in metric (mm) enter tolerance data in metric (mm).

## Chapter 5 Advanced Measuring & Output

Step 4

Select a reference feature from the pull down list.

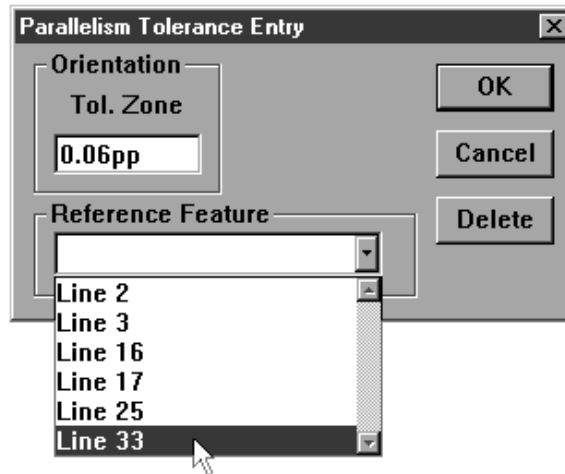

Step 5

Click OK in the dialog box.

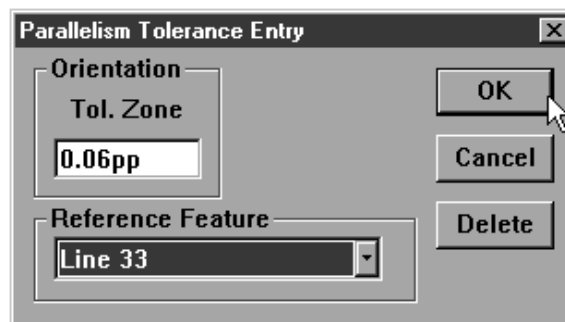

The tolerance results window appears as shown.

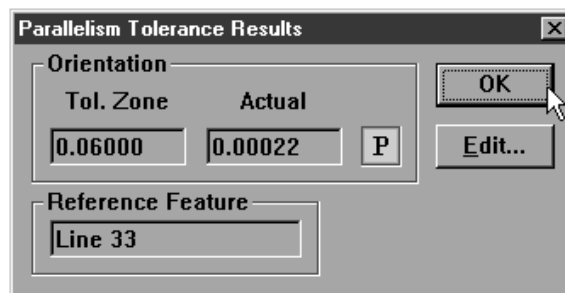



**Circular runout tolerance**

Use circular runout to set a tolerance of how far circular features may deviate from the center of a reference feature in 360 degrees of rotation.

**To perform a circular runout tolerance**

Step 1

Highlight the desired feature in the features list.

I	T	Name	Datum	X	Y	Z	d	r
○	●	Sphere 29		4.48000	0.71786	0.18807	1.00000	0.5000
○	○	Circle 30		5.75060	3.75804	-0.03074	0.78381	0.3919
○	●	Cylinder		5.75350	3.75831	-0.21500	0.75249	0.3762
○	○	Circle 32		5.75441	3.75904	-0.01261	0.75167	0.3756
/		Line 33		7.09668	3.70053	-0.00320		
/		Line 34		7.04016	4.07377	-0.01127		
○	●	Circle 35		7.31997	3.15897	-0.00215	0.95651	0.4782
○	○	Circle 36		7.32025	3.15833	-0.31064	0.42460	0.2123

**NOTE**

Use a circle only. Circular runout tolerances do not apply to other types of features.

Step 2

Click the *circular runout* button on the tolerance toolbar.

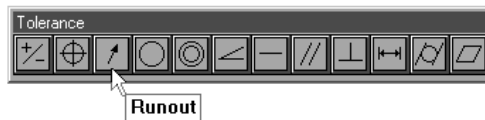

Step 3

Enter a value in the *tolerance zone* box as shown.

**Runout Tolerance Entry**

Circular Runout

Tol. Zone:

Reference Feature:

Buttons: OK, Cancel, Delete

**CAUTION**

Enter tolerance values in the appropriate units of measurement. For example, if you are measuring in metric (mm) enter tolerance data in metric (mm).

## Chapter 5 Advanced Measuring & Output

Step 4

Select a reference feature from the pull down list.

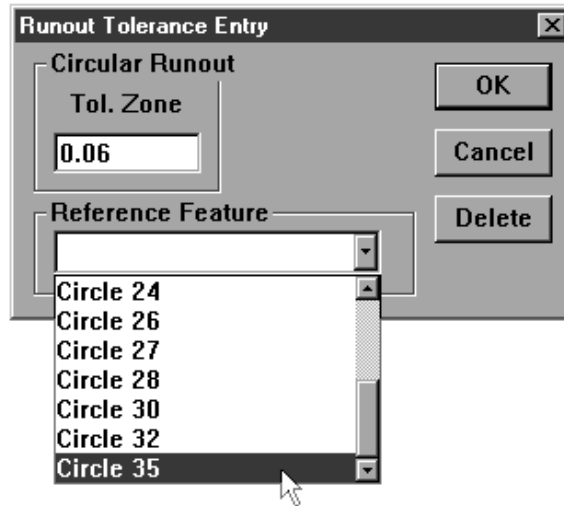

Step 5

Click OK in the dialog box.

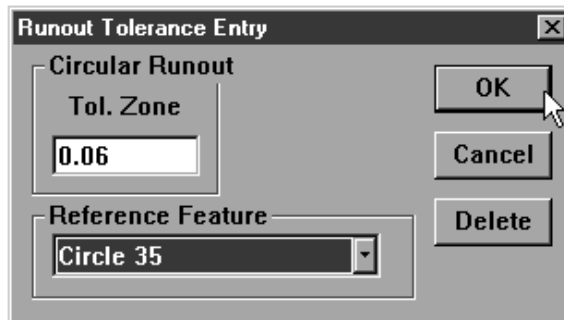

The tolerance results window appears as shown.

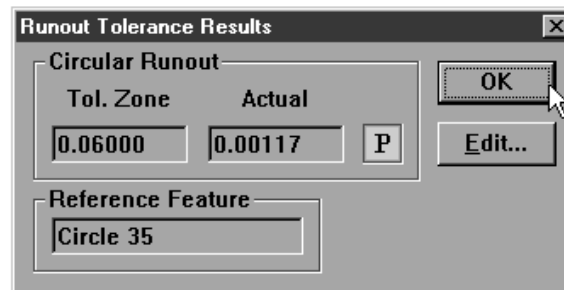

**Angle tolerance**

Use angle tolerance to set tolerance values for angles in a specified plane. Enter the respective nominal values for the angle according to its plane. For example, enter XY nominal values for angles in the XY plane.

**To perform an angle tolerance**

**Step 1**

Highlight the desired angle in the features list.

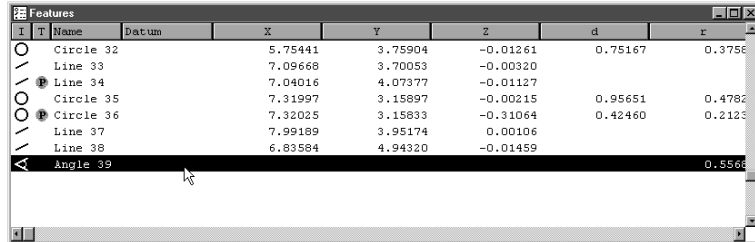

**NOTE**

Use angles only. Angle tolerances do not apply to other types of features.

**Step 2**

Click the *angle* button on the tolerance toolbar.

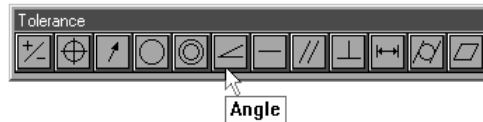

**Step 3**

Enter the nominal values as shown.

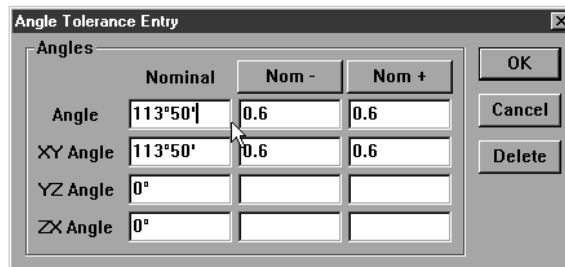

**CAUTION**

Enter tolerance values in the appropriate units of measurement. For example, if you are measuring in metric (mm) enter tolerance data in metric (mm).

## Chapter 5 Advanced Measuring & Output

Step 4

Enter the nominal + and nominal - values as shown.

Angles	Nominal	Nom -	Nom +
Angle	113°50'	0.6	0.6
XY Angle	113°50'	0.6	0.6
YZ Angle	0°		
ZX Angle	0°		

Step 5

Click OK in the dialog box.

Angles	Nominal	Nom -	Nom +
Angle	113°50'	0.6	0.6
XY Angle	113°50'	0.6	0.6
YZ Angle	0°		
ZX Angle	0°		

The tolerance results window appears as shown.

Angles	Nominal	Actual	Deviation	Low limit	High limit
Angle	113°50'	112°51'03"	0°58'57"	112°50'	114°50'
XY Angle	113°50'	112°51'03"	0°58'57"	112°50'	114°50'
YZ Angle	0°	0°	0°		
ZX Angle	0°	0°	0°		

**Width tolerance**

Use the width tolerance to establish the amount of deviation in the distance between two linear features.

**To perform a width tolerance**

Step 1

Highlight the desired distance in the features list.

I	T	Name	Datum	X	Y	Z	d	r
		Circle 35		7.31997	3.15897	-0.00215	0.95651	0.4782
		Circle 36		7.32025	3.15833	-0.31064	0.42460	0.2123
		Line 37		7.99189	3.95174	0.00106		
		Line 38		6.83584	4.94320	-0.01459		
		Angle 39						0.5566
		Line 40		5.01678	2.95610	-0.12519		
		Line 41		4.64559	2.88707	-0.14009		
		Distance		0.37435	0.03673	0.00000		

**NOTE**

Use a distance only. Width tolerances do not apply to other types of features.

Step 2

Click the *width* button on the tolerance toolbar.



Step 3

Enter the nominal values as shown.

Width Tolerance Entry			
Length			
	Nominal	Nom -	Nom +
Length	0.375		
X	0.375		
Y	0.03673		
Z	0.00000		

**CAUTION**

Enter tolerance values in the appropriate units of measurement. For example, if you are measuring in metric (mm) enter tolerance data in metric (mm).

## Chapter 5 Advanced Measuring & Output

Step 4

Enter the nominal + and nominal - values as shown.

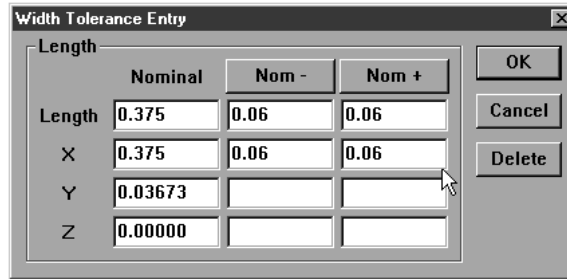

The dialog box titled "Width Tolerance Entry" contains a table for entering tolerance values. The table has columns for "Nominal", "Nom -", and "Nom +". The rows are for "Length", "X", "Y", and "Z". The "Length" row has values 0.375, 0.06, and 0.06. The "X" row has values 0.375, 0.06, and 0.06. The "Y" row has 0.03673 in the "Nominal" column. The "Z" row has 0.00000 in the "Nominal" column. Buttons for "OK", "Cancel", and "Delete" are on the right.

	Nominal	Nom -	Nom +
Length	0.375	0.06	0.06
X	0.375	0.06	0.06
Y	0.03673		
Z	0.00000		

Step 5

Click OK in the dialog box.

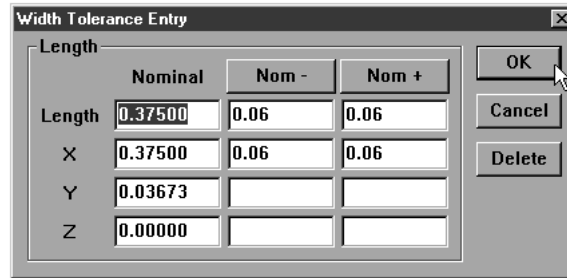

The dialog box is the same as in Step 4, but the "OK" button is highlighted with a mouse cursor. The "Length" row now shows a value of 0.37500 in the "Nominal" column.

	Nominal	Nom -	Nom +
Length	0.37500	0.06	0.06
X	0.37500	0.06	0.06
Y	0.03673		
Z	0.00000		

The tolerance results window appears as shown.

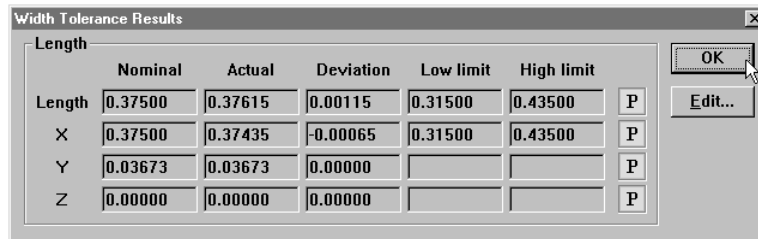

The dialog box titled "Width Tolerance Results" displays the results of the tolerance analysis. It has columns for "Nominal", "Actual", "Deviation", "Low limit", "High limit", and a pass/fail indicator "P". The "Length" row shows an actual value of 0.37615 and a deviation of 0.00115. The "X" row shows an actual value of 0.37435 and a deviation of -0.00065. The "Y" and "Z" rows show actual values of 0.03673 and 0.00000, respectively, with zero deviation. Buttons for "OK" and "Edit..." are on the right.

	Nominal	Actual	Deviation	Low limit	High limit	
Length	0.37500	0.37615	0.00115	0.31500	0.43500	P
X	0.37500	0.37435	-0.00065	0.31500	0.43500	P
Y	0.03673	0.03673	0.00000			P
Z	0.00000	0.00000	0.00000			P

# Chapter 6

## Templates

### Templates

Templates control the format of output. There are four templates used by the QC5000:

- Features Template
- Report Template
- Program Template
- Runs Template

Features and report templates are associated with data output. Use the features template to format data for output to other software applications.



Format print output using the report template.

#	Feature	Position/Dim.	Size	Orientation	Form/Dim.	Special
1	Plane 1	X 3.22598 Y 1.56296 Z 0.00000		XY< 0°00'00" YZ< 90°00'00" ZX< 0°00'00"	F 0.00000	
2	Line 2	X 0.00000 Y 1.47039 Z -0.45201		XY< 90°00'00" YZ< 0°00'00" ZX< 0°00'00"	F 0.00000	
3	Line 3	X 2.26751 Y -0.00139 Z -0.45531		XY<179°57'53" YZ< 0°00'00" ZX< 90°00'00"	F 0.00000	
4	Point 4	X 0.00000 Y 0.00000 Z -0.45366			F 0.00000	
5	Point 5	X 3.57722 Y 1.48131 Z 0.00010			F 0.00000	
6	Line 6	X 1.81104 Y 0.71418 Z -0.21084		XY< 89°58'23" YZ<180°00'00" ZX< 90°00'00"	F 0.00000	
7	Arc 7	X 4.49242 Y 0.75257 Z -0.01497	d 1.51415 r 0.75707		L3d 0.05810 F 0.00000	

Program and runs templates are associated with QC5000 functions. Use the program template to construct, edit, and monitor your parts programs.



## Chapter 6 Templates

---

Compare program results from one run to the next using the runs template.





## Features Template

Use the features template to create the features list. The features list displays feature data and prepares it for export to other software applications.

### To open the features template

#### Step 1

Select *open template* from the windows menu.

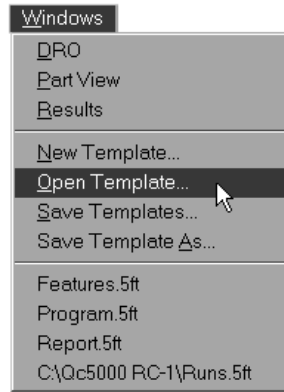

#### Step 2

Select *features.5ft* from the file name list box. The file path is c:\qc5000\templates.

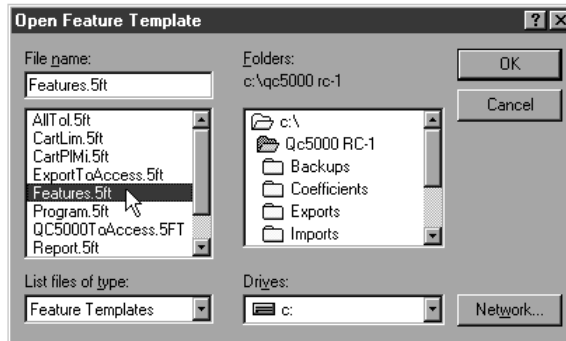

#### Step 3

Click OK.

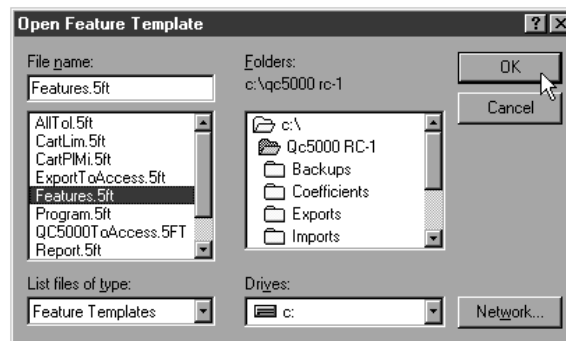

OR

### Step 1

Select features.5ft from the windows menu.

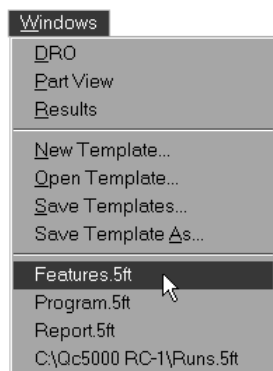

## Adding Data to Templates

Add data to the features list by dragging and dropping information from the results window.

### To drag and drop a single results window field into the features list

#### Step 1

Highlight the desired field in the results window.

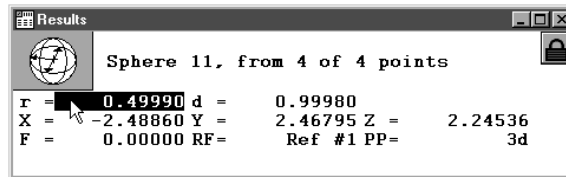

#### Step 2

Hold down the left mouse button and move the field over the features list.

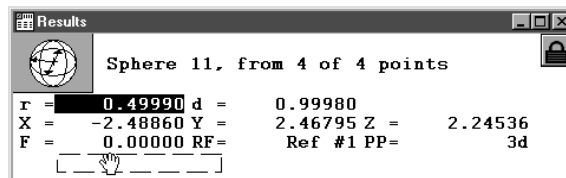

#### Step 3

Release the left mouse button.

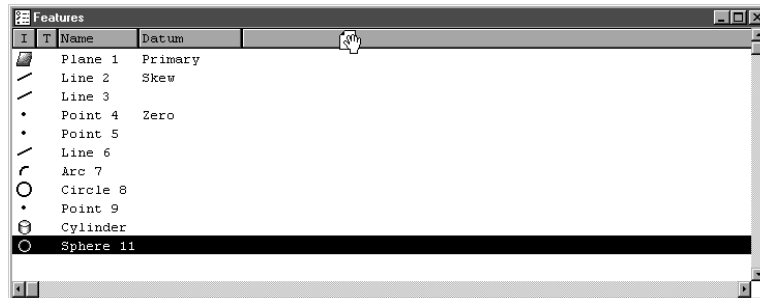

**To drag and drop a multiple results window fields into the features list**

Step 1

Highlight the desired fields in the results window.

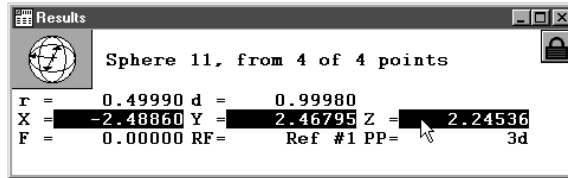

Step 2

Hold down the left mouse button and move the fields over the features list.

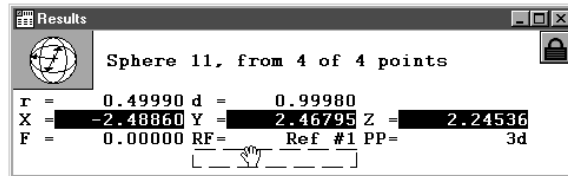

Step 3

Release the left mouse button.

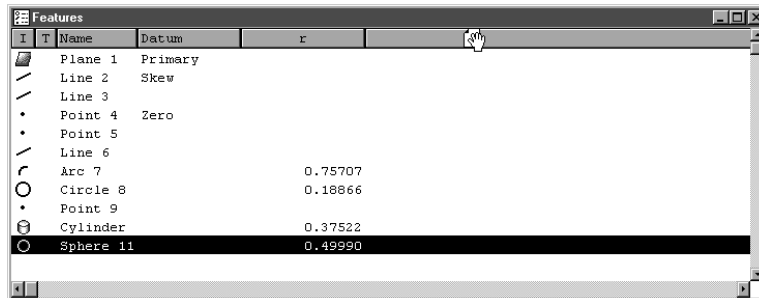

Step 4

Click the *as multiple new columns* button in the dialog box.



**NOTE**  
Use the as 1 new column button if the fields are intended to occupy only one column.

### Sorting the Features List

Sort data in the features list by clicking on the column header. Each data column can be arranged from high to low, low to high, or by order entered.

#### To sort data in the features list

##### Step 1

Place the cursor on the desired column header.

I	T	Name	Datum	r	X	Y	Z
•		Point 9			4.53139	0.74913	-0.16713
∩		Arc 7		0.75707	4.49242	0.75257	-0.01497
•		Point 5			3.57722	1.48131	0.00010
▢		Plane 1	Primary		3.22598	1.56296	0.00000
○		Cylinder		0.37522	3.00035	1.49760	-0.26424
○		Circle 8		0.18866	2.99882	2.49648	0.00203
/		Line 3			2.26751	-0.00139	-0.45531
/		Line 6			1.81104	0.71418	-0.21084
/		Line 2	Skew		0.00000	1.47039	-0.45201
•		Point 4	Zero		0.00000	0.00000	-0.45366
○		Sphere 11		0.49990	-2.48860	2.46795	2.24536

##### Step 2

Click on the column header.

I	T	Name	Datum	r	X	Y	Z
▢		Plane 1	Primary		3.22598	1.56296	0.00000
/		Line 2	Skew		0.00000	1.47039	-0.45201
/		Line 3			2.26751	-0.00139	-0.45531
•		Point 4	Zero		0.00000	0.00000	-0.45366
•		Point 5			3.57722	1.48131	0.00010
/		Line 6			1.81104	0.71418	-0.21084
•		Point 9			4.53139	0.74913	-0.16713
○		Circle 8		0.18866	2.99882	2.49648	0.00203
○		Cylinder		0.37522	3.00035	1.49760	-0.26424
○		Sphere 11		0.49990	-2.48860	2.46795	2.24536
∩		Arc 7		0.75707	4.49242	0.75257	-0.01497

A small arrow to the right of the column label indicates the arrangement:

- high to low (arrow down)

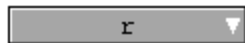

- low to high (arrow up)

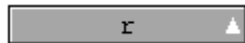

- order entered (no arrow)



## Chapter 6 Templates

### Reports Template

Use the reports template to prepare data in a standard print format. The reports template displays the same feature data as the features template in a printer-friendly format. Add data to the reports template by dragging and dropping information from the results window.

#### To open the reports template

##### Step 1

Select *open template* from the windows menu.

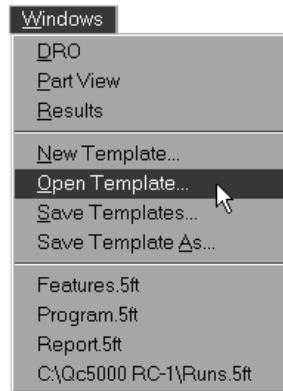

##### Step 2

Select *report.5ft* from the file name list box. The file path is c:\qc5000\templates.

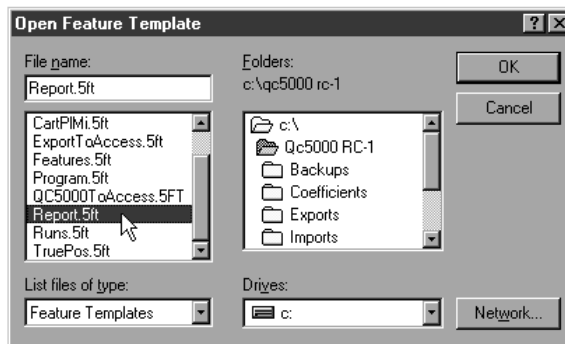

##### Step 3

Click OK.

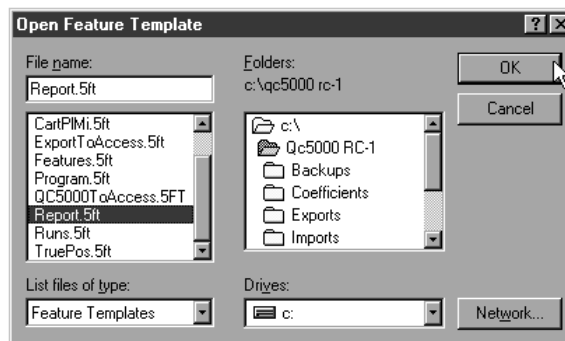

OR

Step 1  
Select *reports.5ft* from the windows menu.

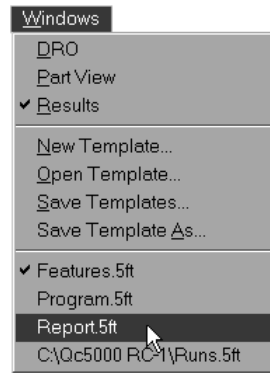

**Adding Data to the Reports Template**

Add data to the reports template by dragging and dropping information from the results window.

**To drag and drop a single results window field into the reports template**

Step 1

Highlight the desired field in the results window.

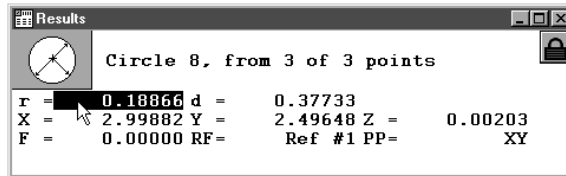

Step 2

Hold down the left mouse button and move the field over the reports template.

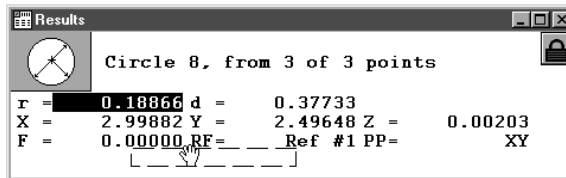

Step 3

Release the left mouse button.

The Report window displays a table with the following data:

#	Feature	Position/Dim.	Size	Orientation	Form/Dim.
6	Line 6	X 1.81104 Y 0.71418 Z -0.21084		XY< 89°58'23" YZ<180°00'00" ZX< 90°00'00"	F 0.00000
7	Arc 7	X 4.49242 Y 0.75257 Z -0.01497	d 1.51415 r 0.75707		L3d 0.05810 F 0.00000
8	Circle 8	X 2.99882 Y 2.49648 Z 0.00203	d 0.37733 r 0.18866		F 0.00000
9	Point 9	X 4.53139 Y 0.74913 Z -0.16713			F 0.40007



**To drag and drop a multiple results window fields into the reports template**

**Step 1**

Highlight the desired fields in the results window.

	Orientation	Form/Dim.	r	
	XY< 89°58'23"	F 0.00000		
	YZ<180°00'00"			
	ZX< 90°00'00"			
51415		L3d 0.05810	0.75707	
75707		F 0.00000		
37733		F 0.00000	0.18866	
18866				
		F 0.40007		

**Step 2**

Hold down the left mouse button and move the fields over the reports template.

Circle 8, from 3 of 3 points

r = 0.18866 d = 0.37733  
 X = 2.99882 Y = 2.49648 Z = 0.00203  
 F = 0.00000 RF = Ref #1 PP = XY

**Step3**

Release the left mouse button.

	Orientation	Form/Dim.	r	
	XY< 89°58'23"	F 0.00000		
	YZ<180°00'00"			
	ZX< 90°00'00"			
51415		L3d 0.05810	0.75707	
75707		F 0.00000		
37733		F 0.00000	0.18866	
18866				
		F 0.40007		

**Step 4**

Click the *as multiple new columns* button in the dialog box.

QC5000

? How do you want the fields added to this template?

Include labels with data

As 1 New Column

As Multiple New Columns



**NOTE**

Use the as 1 new column button if the fields are intended to occupy only one column.

**Sorting Data in the Reports Template**

Sort data in the reports template by clicking on the column header. Each data column can be arranged from high to low, low to high, or by order entered.

**To sort data in the reports template**

**Step 1**

Place the cursor on the desired column header.

on/Dim.	Size	Orientation	Form/Dim.	r	X	Z
1.81104		XY< 89°58'23"	F 0.00000		1.81104	-0.2
0.71418		YZ<180°00'00"				
0.21084		ZX< 90°00'00"				
2.26751		XY<179°57'53"	F 0.00000		2.26751	-0.4
0.00139		YZ< 0°00'00"				
0.45531		ZX< 90°00'00"				
2.99882	d 0.37733		F 0.00000	0.18866	2.99882	0.0
2.49648	r 0.18866					
0.00203						
3.00035	d 0.75044	XY<153°51'02"	F 0.00115	0.37522	3.00035	-0.2
1.49760	r 0.37522	YZ< 89°53'05"				
0.26424		ZX<359°45'53"				

**Step 2**

Click on the column header.

on/Dim.	Size	Orientation	Form/Dim.	r	X	Z
2.26751		XY<179°57'53"	F 0.00000		2.26751	-0.4
0.00139		YZ< 0°00'00"				
0.45531		ZX< 90°00'00"				
0.00000			F 0.00000		0.00000	-0.4
0.00000						
0.45366						
3.57722			F 0.00000		3.57722	0.0
1.48131						
0.00010						
1.81104		XY< 89°58'23"	F 0.00000		1.81104	-0.2
0.71418		YZ<180°00'00"				
0.21084		ZX< 90°00'00"				

A small arrow to the right of the column label indicates the arrangement:

- high to low (arrow down)

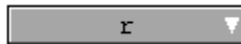

- low to high (arrow up)

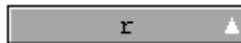

- order entered (no arrow)

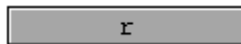

## Report Headers

Report headers contain additional information that is placed at the top of the first report page. Users can customize report headers to suit specific application or documentation needs.

### To show a report header

#### Step 1

Right click on the reports template.

on/Dim.	Size	Orientation	Form/Dim.	r	X	Z
2.26751		XY<179°57'53"	F 0.00000		2.26751	-0.4
0.00139		YZ< 0°00'00"				
0.45531		ZX< 90°00'00"				
0.00000			F 0.00000		0.00000	-0.4
0.00000						
0.45366						
3.57722			F 0.00000		3.57722	0.0
1.48131						
0.00010						
1.81104		XY< 89°58'23"	F 0.00000		1.81104	-0.2
0.71418		YZ<180°00'00"				
0.21084		ZX< 90°00'00"				

#### Step 2

Select *template properties* from the list.

#### Step 3

Use the mouse to check the show report header check box.

Step 4  
Click OK in the dialog box.

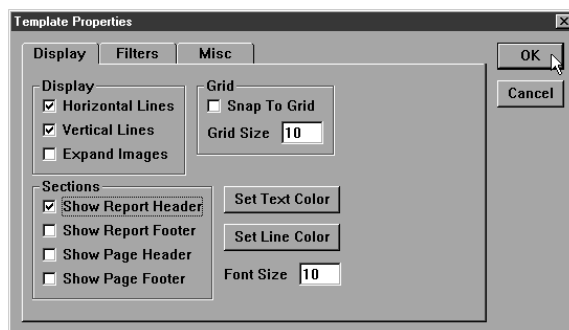

### Customizing Report Headers

Users can edit report headers to suit individual needs. Report headers can include text and graphics.

#### To place a graphic in a report header

**Step 1**

Right click on the report header and select *add image* from the list.

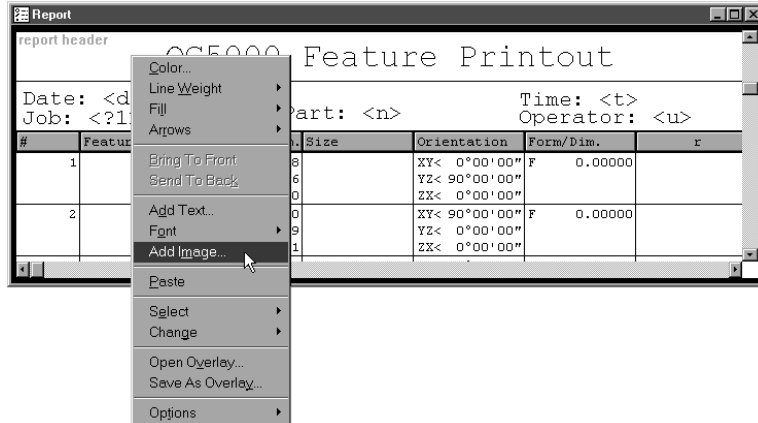

**Step 2**

Select the graphic file.

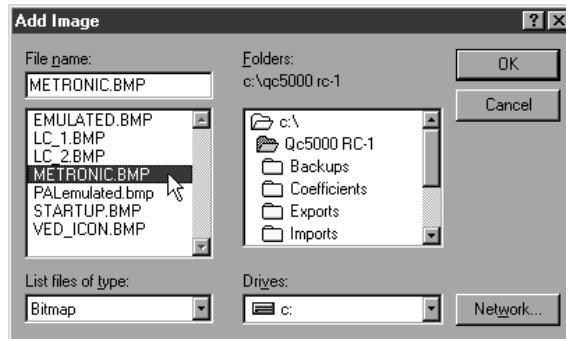

**Step 3**

Click OK in the dialog box.

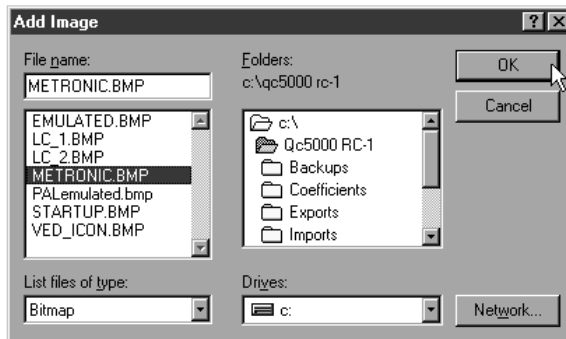

To arrange text and graphics in a report header

Step 1  
Click on the text or graphic to be moved.

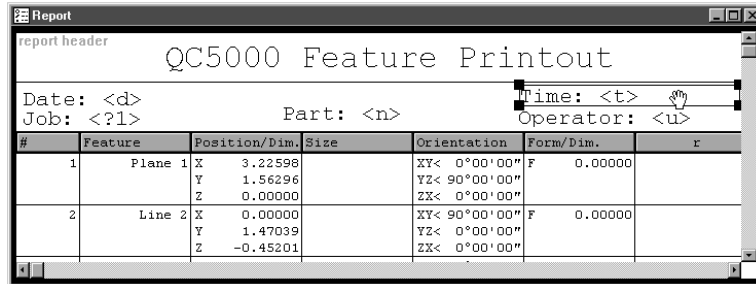

Step 2  
Hold down the mouse button and drag the object to the desired location.

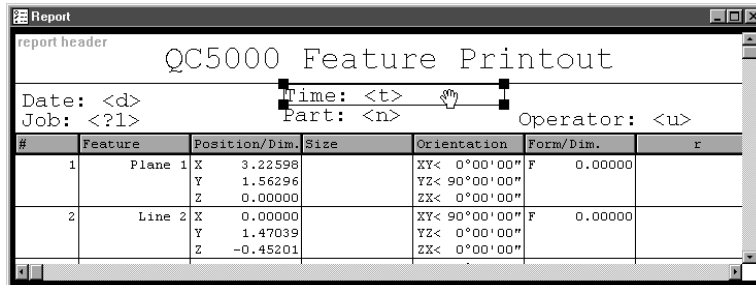

Step 3  
Release the mouse button.

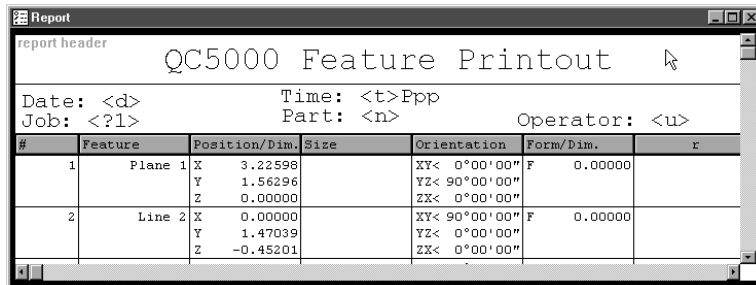

## Automated Text Input & Prompting

Use automated text input and prompting to automatically supply text input or to request it from the user. The QC5000 recognizes these automated text inputs:

- <u> prints the user name from login
- <n> prints the part name
- <d> prints the date
- <t> prints the current time
- <x> prints the max number of pages
- <p> prints the current page number



### NOTE

**Automated text inputs are case sensitive. For example, <U> is NOT the same as <u>.**

Use automated input prompts to request text entry from the user. For example,

**Part number: <?1>**

prompts the user to enter the part number in the report header before printing.

Enter automated input prompts sequentially. For example, if <?1> is used for prompting the part number use <?2> for the next input prompt.

## Chapter 6 Templates

### Overlays

Save headers for repeated use as overlays. Using an overlay saves the time and trouble of creating the same header for each new job.

#### To save a report header as an overlay

##### Step 1

Right click on the report header and select *save as overlay* from the list.

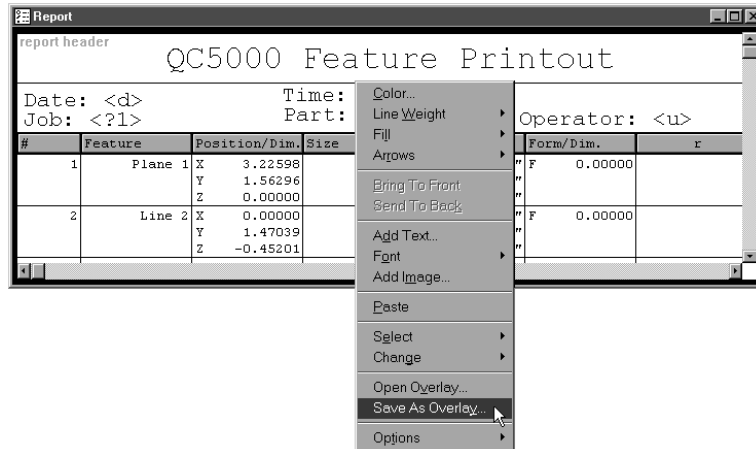

##### Step 2

Type a name for the overlay as shown.

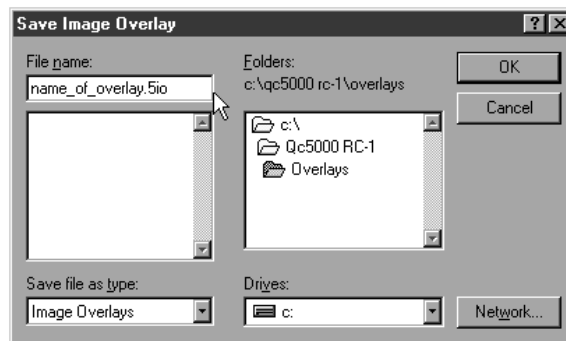

##### Step 3

Click OK in the dialog box.

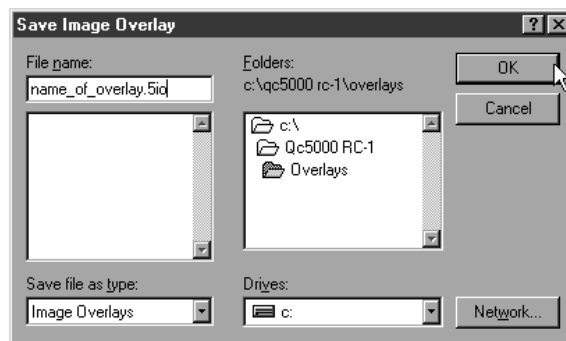



**To place an overlay in a report header**

**Step 1**

Right click on the report header and select *open overlay* from the list.

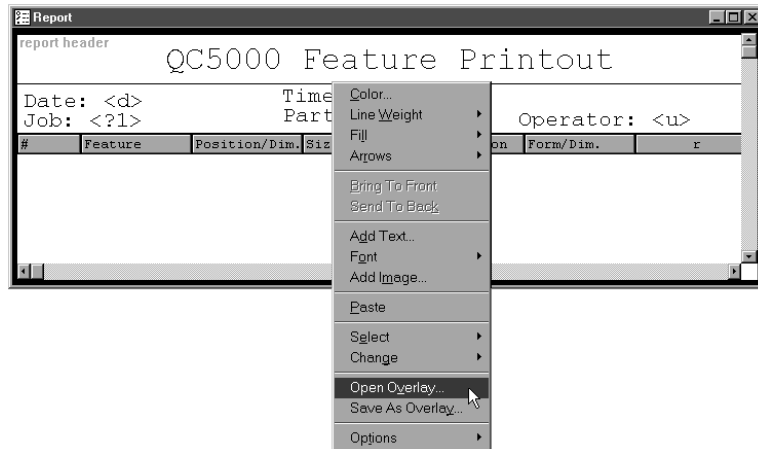

**Step 2**

Select the overlay as shown.

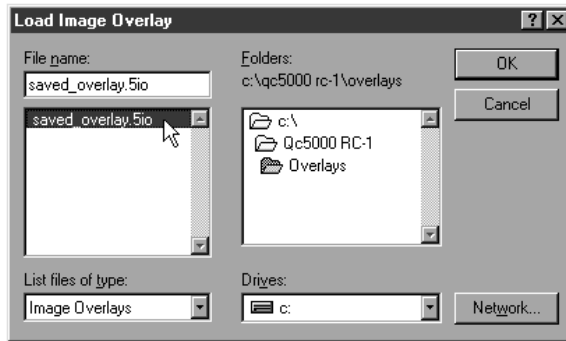

**Step 3**

Click OK in the dialog box.

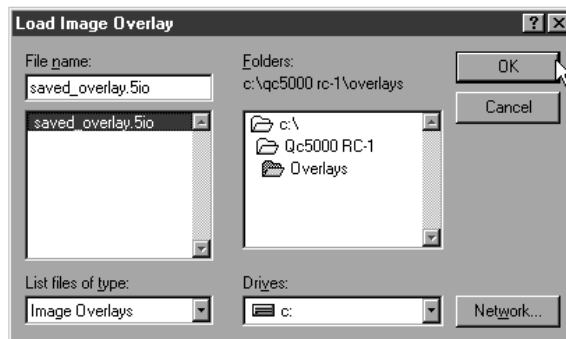

### Program Template

Use the program template to monitor the steps of a parts program. Green checkmarks indicate steps successfully completed and a blue arrow points to the current step. Loop counts are displayed in the data column. Programs can be set to run a certain number of times. This is referred to as 'looping' and each individual run is a 'loop.'

Program templates display information only. No data from the features list can be imported to the the program template.

### To open the program template

#### Step 1

Select *open template* from the windows menu.

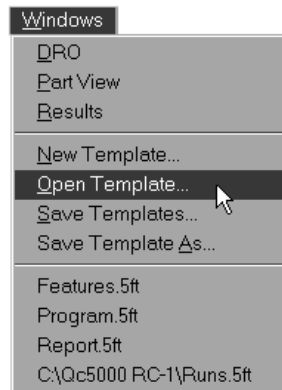

#### Step 2

Select *program.5ft* from the file name list box. The file path is *c:\qc5000\templates*.

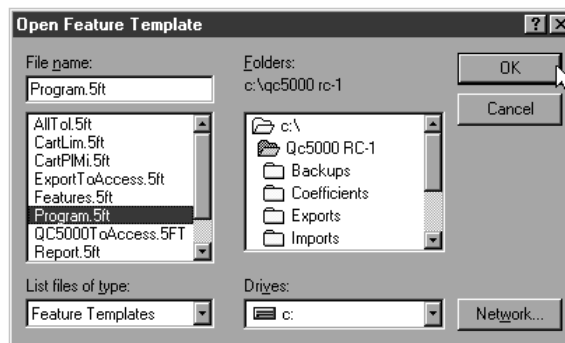

OR

Step 1

Select *program.5ft* from the windows menu.

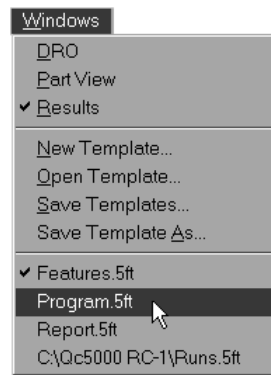

### Template Properties

Standard template features can be modified by the user. Use the template properties dialog box to modify QC5000 templates to suit your application.

#### To access the template features dialog box

Step 1

Right click on any template.

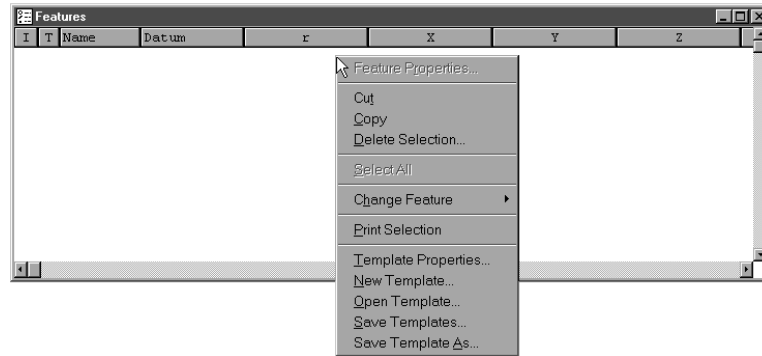

Step 2

Select *template properties* from the list.

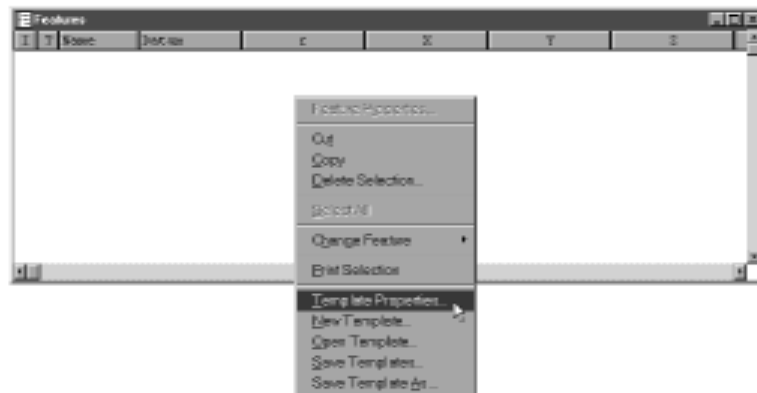

### Template Features Dialog Box

The template features dialog box contains three tabs: display, filters, and misc (miscellaneous). Click on the *display* tab to modify template display features.

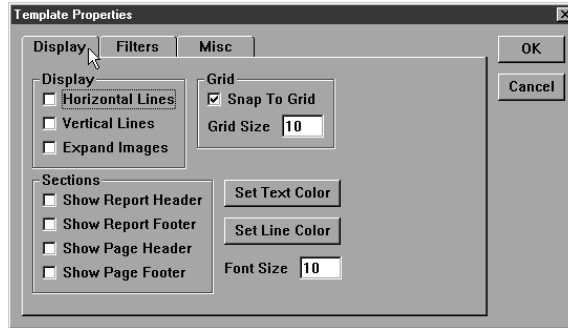

### Display tab

Use the mouse to place check in the horizontal lines check box to display horizontal separator line between each template row.

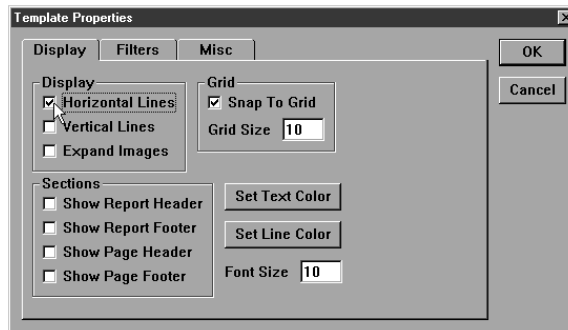

Check the vertical lines box to display vertical separator lines between each template column.

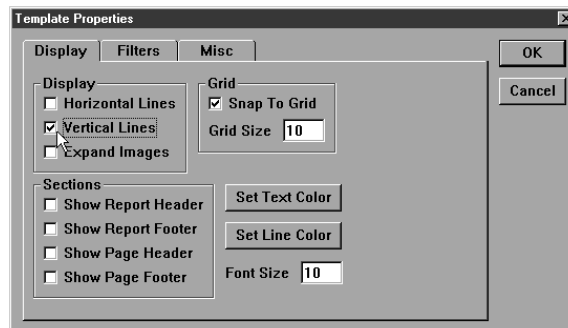

## Chapter 6 Templates

Display partview/image features in a template by checking the *expand images* box.

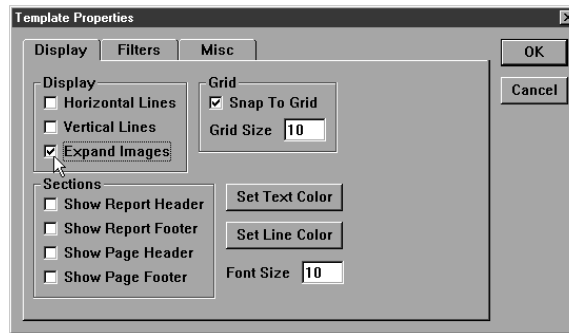

Check the *snap to grid* box to activate the alignment grid in the template. When *snap to grid* is checked fields in the template are automatically aligned to the nearest grid intersection.

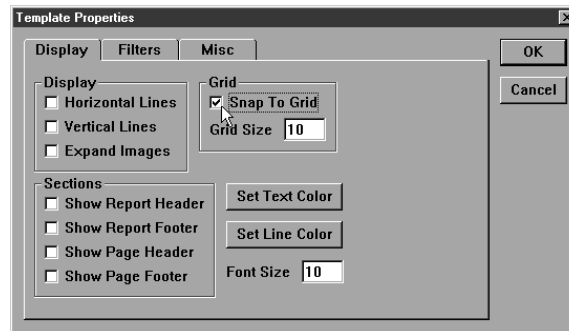

Set the size of the grid squares using the *grid size* text box.

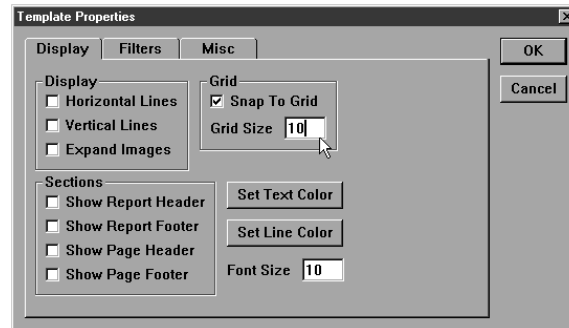

Display a report header at the top of a template by checking the *show report header* box. The report header can include custom text and graphics. Report headers print at the top of the first page of a report.

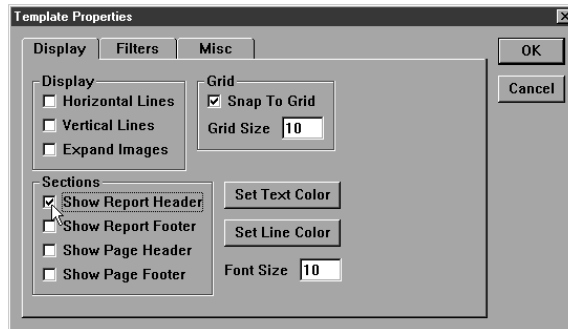

Create a report footer at the bottom of a template by checking the *show report footer* box. Report footers can include custom text and graphics. The report footer prints at the end of a report.

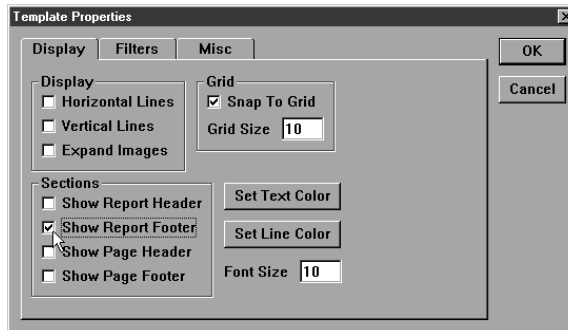

Display a page header at the top of each report page by checking the *show page header* box. The page header can include custom text and graphics.

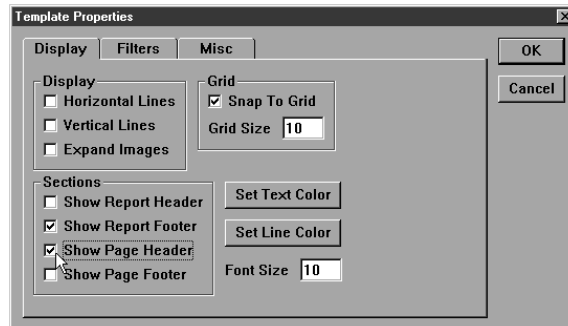

## Chapter 6 Templates

Create a page footer at the bottom of each report page by checking the *show page footer box*. Page footers can include custom text and graphics.

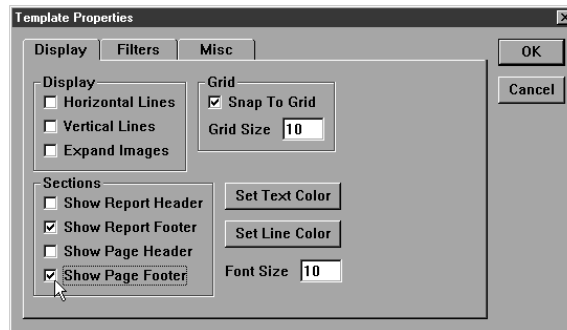

Click on the *set text color* button to change the color of text in the template.

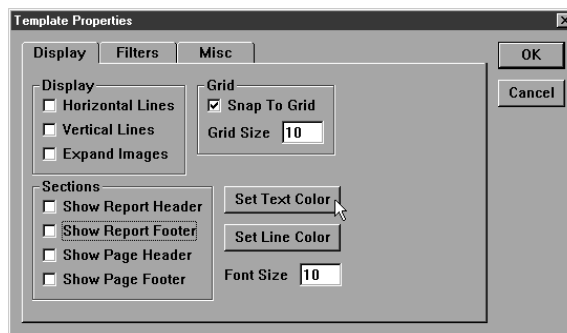

Select a color from the *color* window as shown.

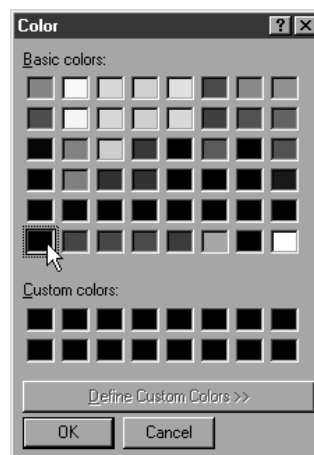



Click on the *set line color* button to change the color of horizontal and vertical lines in the template.

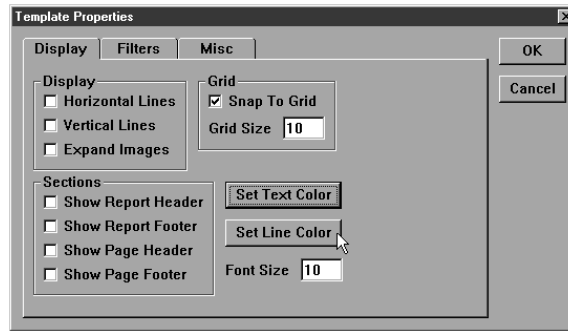

Select a color from the *color* window as shown.

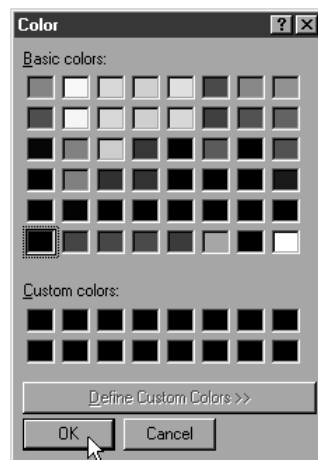

### Filters tab

Filters are conditions (or sets of conditions) that determine what features appear (or do not appear) on a template. Use the filters tab to establish the conditions features must meet to be included or excluded from the template.

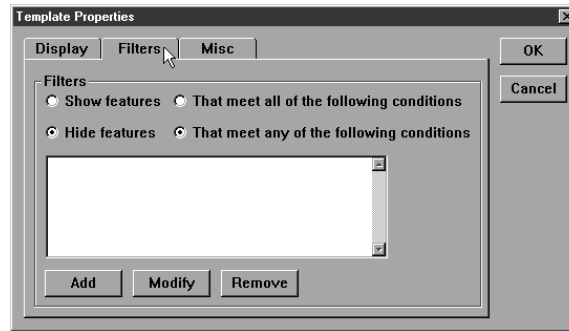

For example, if a part drawing calls for a circle to have a diameter of 0.375 inches with a tolerance of 0.006 inches, you can create a template that displays only circles with a diameter greater than 0.381 inches or less than 0.370 inches. This filter allows the user to track features that fail to meet specifications without having to sort through all the features.

To create a filter



NOTE

This filter is based on the example above but steps can be varied to suit specific applications. Once you have created this filter it is easy to create other filters for your applications.

Step 1

Right click on the template and select *template properties* from the list.

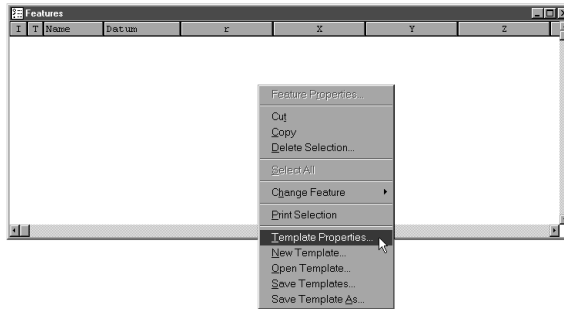

Step 2

Select the *filters* tab in the dialog box.

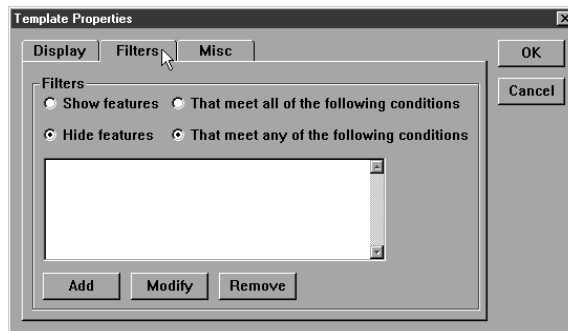

Step 3

Click on the *show features* button.

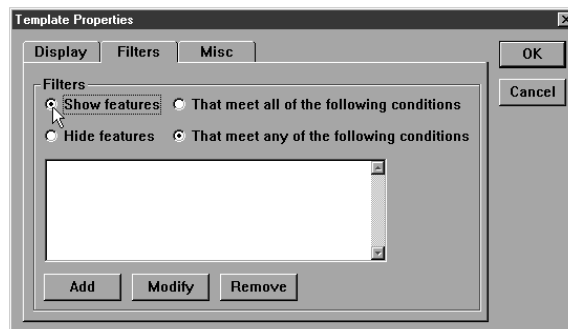

Step 4  
Click on the *that meet any conditions* button.

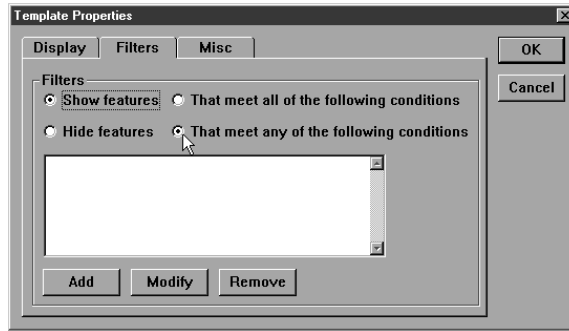

Step 5  
Click the *add* button.

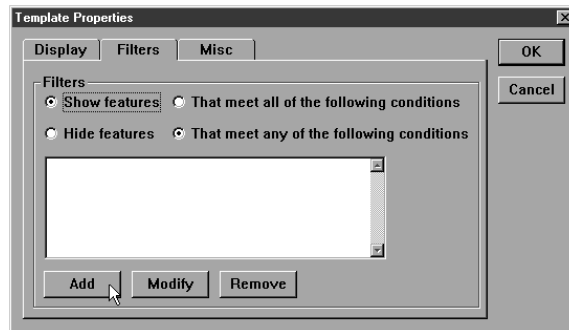

Step 6  
Click the *fields>* button in the filter dialog box.

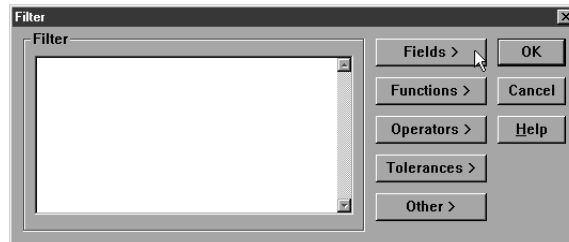

Step 7  
Select *diameter* from the list.

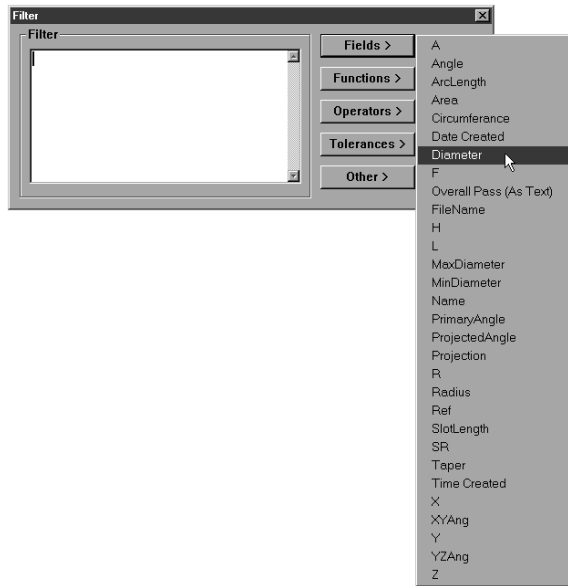

Step 8  
Click the *other>* button.

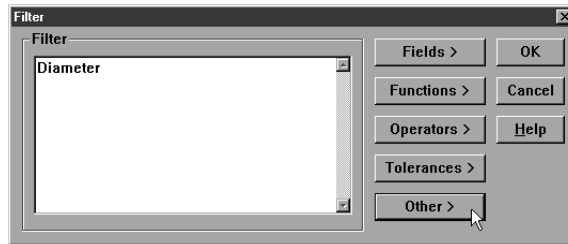

Step 9  
Select the < (less than) symbol from the list.

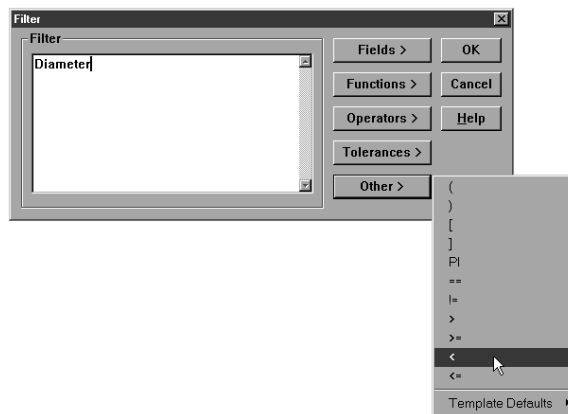

Step 10  
Type 0.370 in the text box as shown.

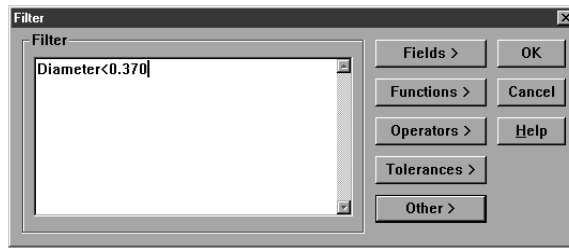

Step 11  
Click OK in the filter dialog box.

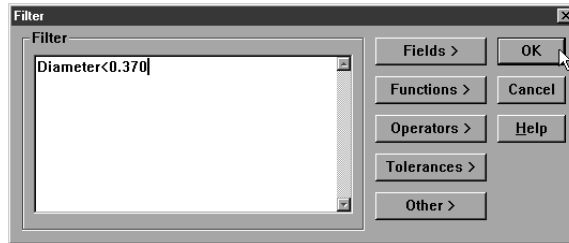

Step 12  
Click the *add* button.

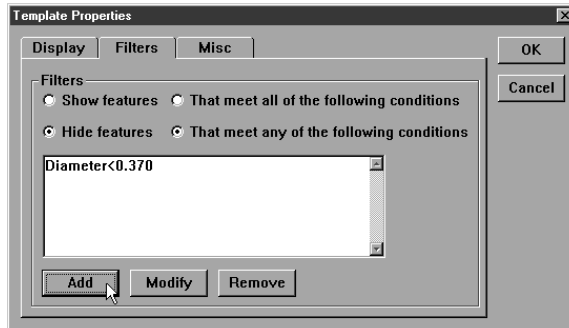

Step 13  
Click the *fields>* button in the filter dialog box.

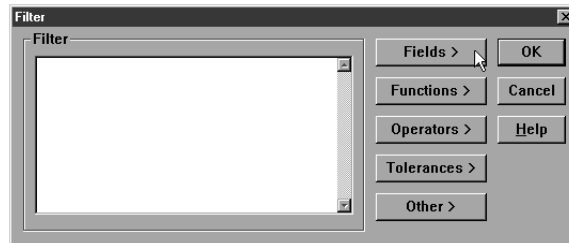

Step 14  
 Select *diameter* from the list.

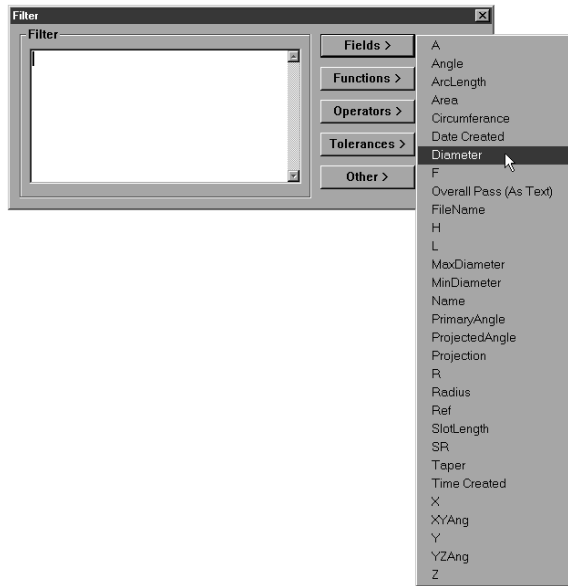

Step 15  
 Click the *other*> button.

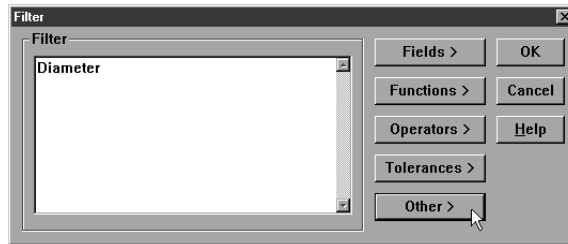

Step 16  
 Select the > (greater than) symbol from the list.

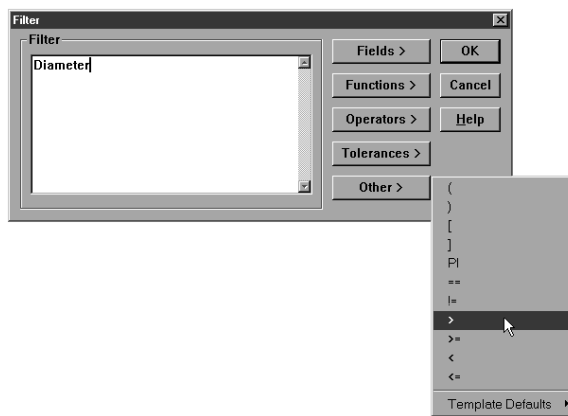

Step 17  
Type 0.381 in the text box as shown.

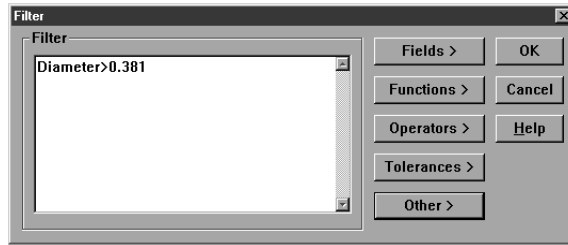

Step 18  
Click OK in the filter dialog box.

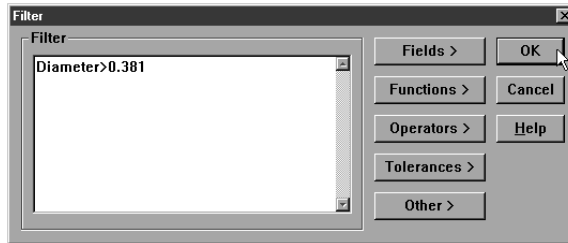

Step 19  
Click OK in the template properties dialog box.

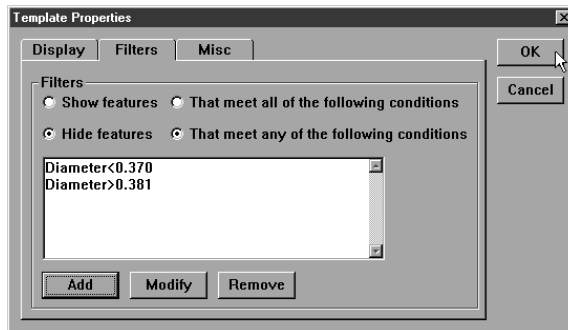



**To modify a filter**

Step 1  
Highlight the desired filter.

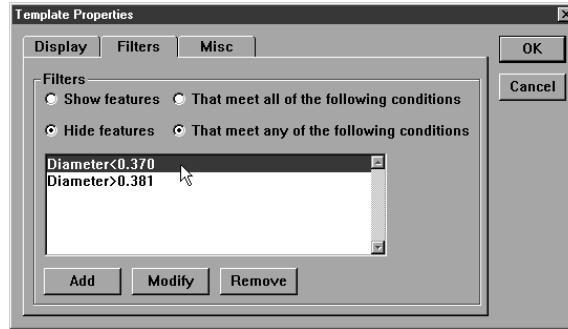

Step 2  
Click the *modify* button on the filters tab (template properties dialog box).

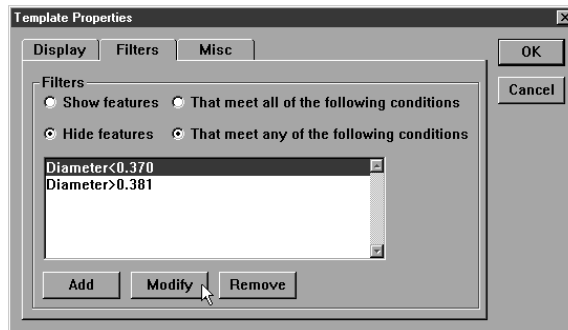

Step 3  
Type in the modification.

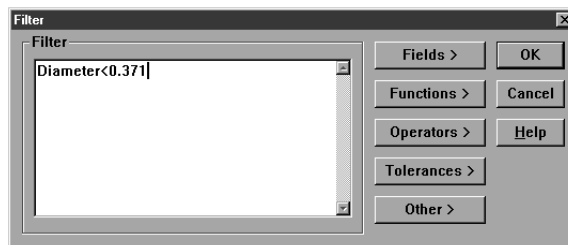

Step 4  
Click OK in the filters dialog box.

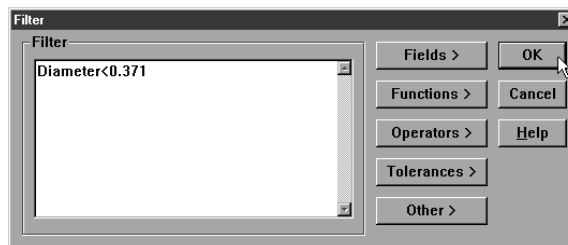

Step 5

Click OK in the template properties dialog box.

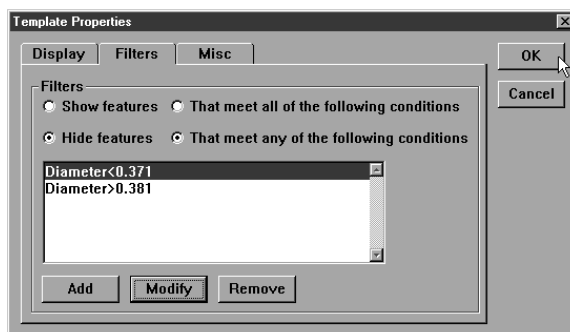

**To remove a filter**

Step 1

Highlight the desired filter on the *filters* tab (template properties dialog box).

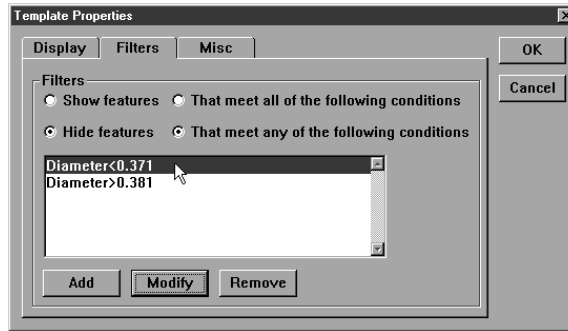

Step 2

Click the *remove* button.

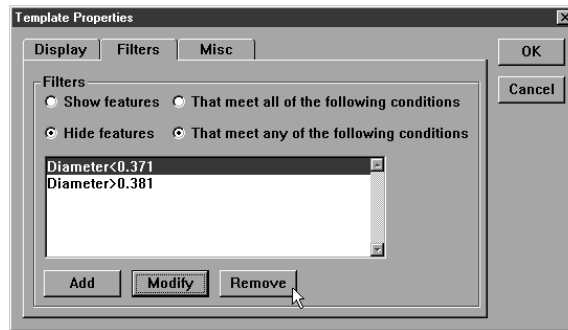

Step 3

Click *yes* in the dialog box.



**Misc tab (miscellaneous)**

The miscellaneous tab contains three check boxes.

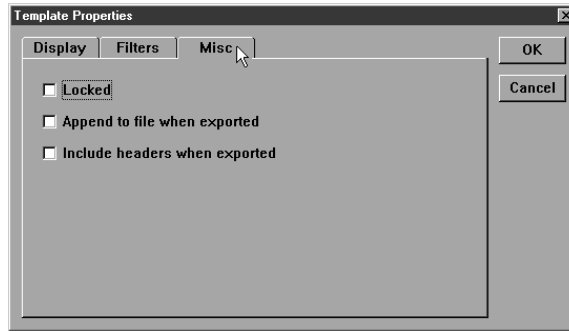

Place a check in the *locked* box to require the supervisor password before templates are edited.

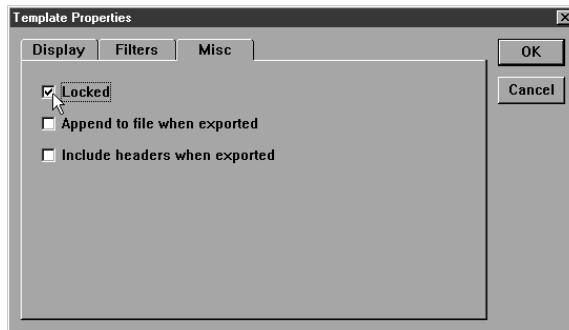

Place a check in the *append to file when exported* box to export template properties.

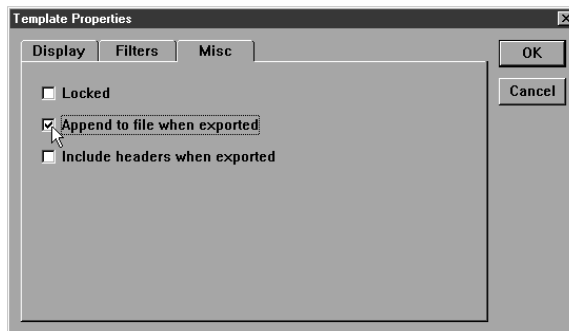

Place a check in the *include headers when exported* box to export report and page headers.

## Column Properties

Columns in each template have properties that can be modified to suit specific application needs. Standard column properties apply to columns in every template. Additionally, there are column properties unique to specific templates.

### Standard column properties

Right click on any template and select column properties from the list. This brings up the column properties dialog box.

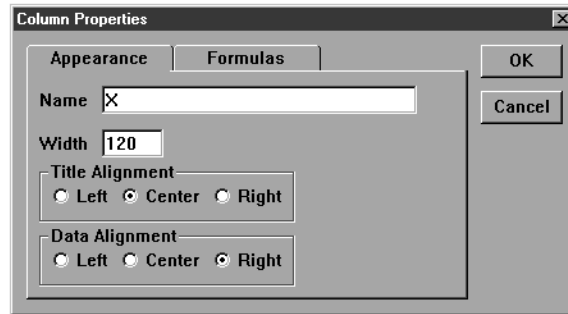

### Appearance tab

The appearance tab allows the user to assign a name to the column, establish column width, title alignment, and data alignment.

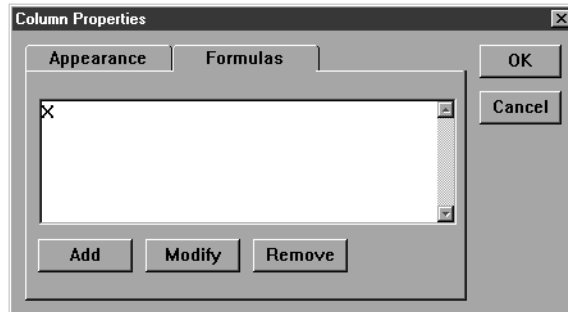

### Formulas tab

Column formulas are conditions (or sets of conditions) that determine what labels appear (or do not appear) with features in a column. Use the formulas tab to establish the conditions features must meet to be labeled.

Use formulas to customize column data and perform calculations. For example, a formula can be written to display the 'X' value of a feature.

A more complex formula can be written to display the standard deviation of several diameters.

### Parantheses( )

Use parantheses to order mathematical equations. For example, in the following equation

$$6*(4+2) = 36$$

the 4 and 2 are added together before being multiplied by the 6.

The same equation without the parantheses is as follows:

$$6*4+2 = 26$$

Here 6 is multiplied by 4 then added to 2.

Work from the innermost set of parantheses to the outermost set in equations using multiple sets of parantheses.

For example,

$$((4+2)*(4+2)+1) = 37$$

Here the addition in the innermost parantheses is performed first, then the two sums are multiplied and added to 1.



### NOTE

**The mathematical order of operations is always multiplication, division, addition, subtraction.**

Parantheses can also be used to call functions such a squares, square root, max, min, etc. For example,

$$\text{sqrt}(100) = 10$$

the function (square root) is performed on the number in the parantheses (100).

### Brackets [ ]

Use brackets to recall previously measured features for a formula. For example,

#### [Circle 1]x

recalls the 'x' value of Circle 1.

A more complex equation might be

$$\text{sqr}([\text{Circle 1}]\text{radius})*\text{PI}$$

Here the radius of Circle 1 is squared and multiplied by pi which produces the area of Circle 1.

### Quote marks ""

Use quote marks to indicate an output in a formula. For example,

$$\text{If}([\text{Circle 1}]\text{radius} \leq 2.0, \text{"Small"})$$

prints the word "Small" in the column if the radius of Circle 1 is less than or equal to 2.0.

A more complex equation might be

$$\text{If}([\text{Circle 1}]\text{radius} \leq 2.0, \text{"Small"}, \text{"Big"})$$

Here the "Small" is printed if the radius of Circle 1 is less than or equal to 2.0 and "Big" is printed if it is greater than 2.0.

Use empty quote marks "" to show no output. For example,

**If([Circle 1]radius>2.0,"","Small")**

gives the same output as

**If([Circle 1]radius<=2.0,"Small")**

using a slightly different formula.

### **Min/Max**

Use the min and max functions to find the minimum or maximum parameter for a series of features. For example,

**Max(-1,-10,"Diameter")**

will produce the maximum diameter of the last 10 circles measured.

## Chapter 6 Templates

### Sample Formula

The following example creates a formula to group circle features into by size.

Use the formula:

**If(Diameter<0.381,"Small","Large")**

to sort circle features into two groups: large or small.

**To create the sample formula**



**NOTE**  
This formula is an example. Steps can be varied to suit specific applications. Once you have created this formula it is easy to create other formulas for your applications.

Step 1

Right click at the top of the template column as shown.

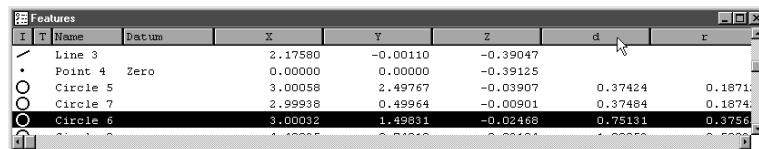

Step 2

Select *column properties* from the list.

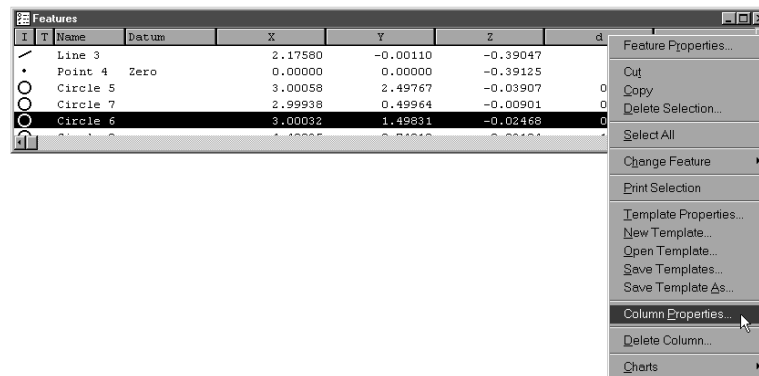

Step 3

Click on the *formulas* tab.

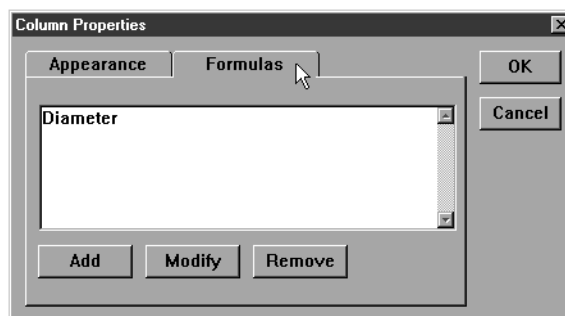



Step 4  
Click *add*.

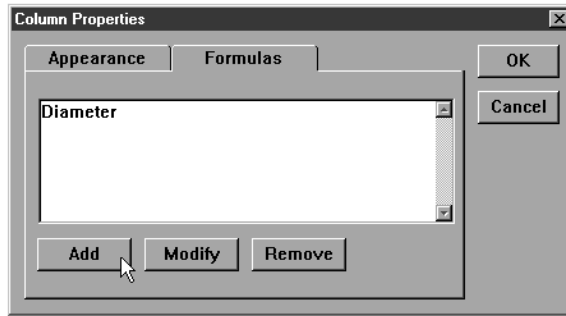

Step 5  
Type 'size group' in the label text box.

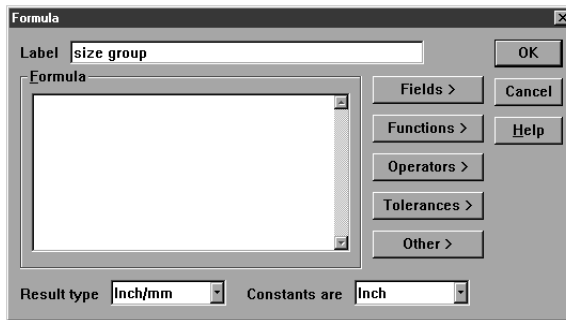

Step 6  
Click on the *fields>* button.

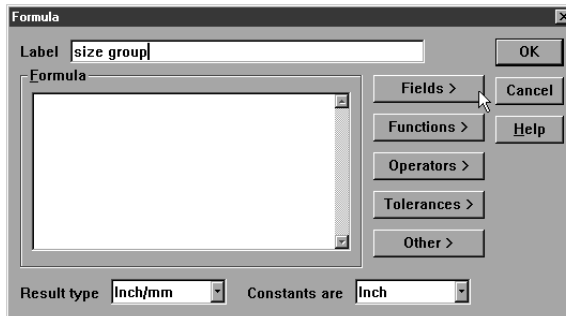

Step 7  
Select *diameter* from the list.



Step 8  
Click on the *other*> button.

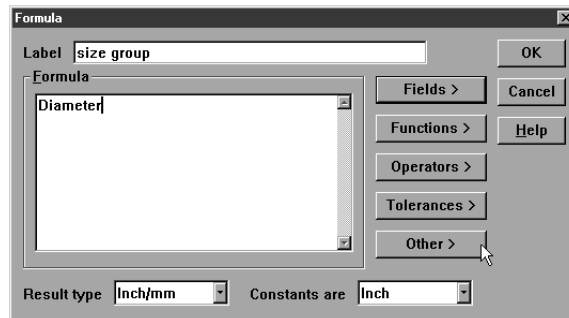

Step 9  
Select the < (less than) symbol from the list.

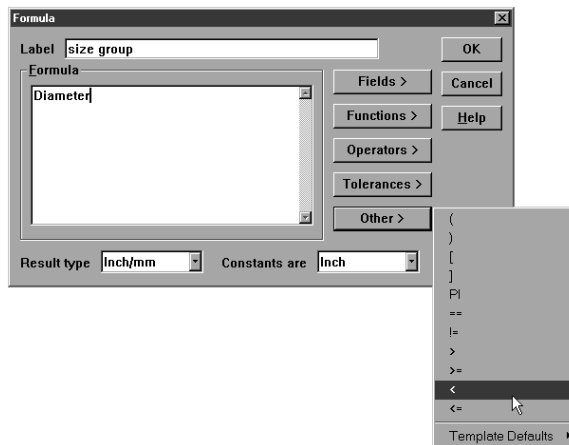

Step 10  
Type 0.381 in the text box as shown.

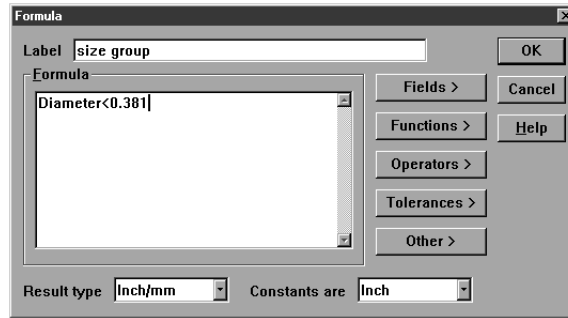

Step 11  
Type in the rest of the formula as follows:  
If(Diameter<0.381,"Small","Large")

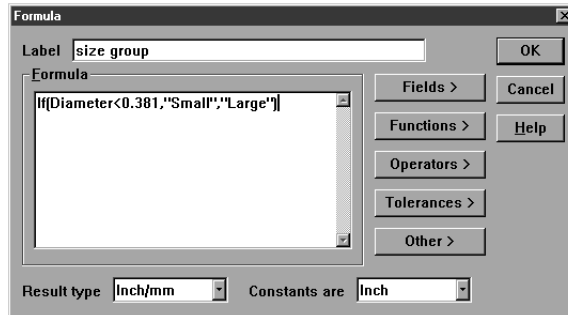

Step 12  
Select *text* from the result type list box.

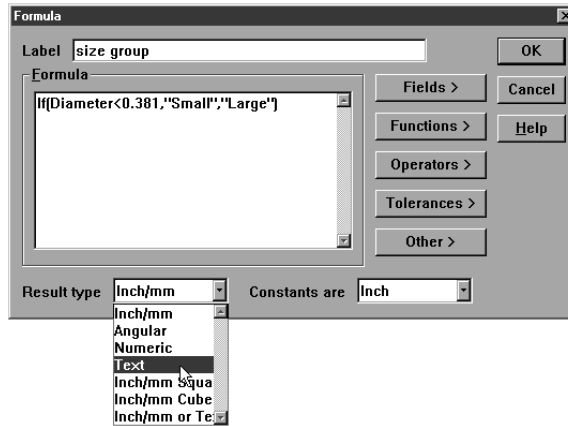

Step 13

Click OK in the formula dialog box.

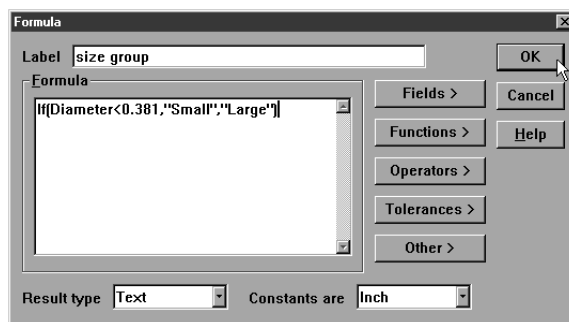

**To modify a formula**

Step 1  
Highlight the desired formula.

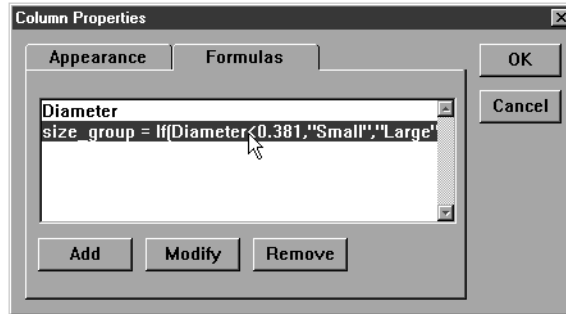

Step 2  
Click the *modify* button on the formulas tab (column properties dialog box).

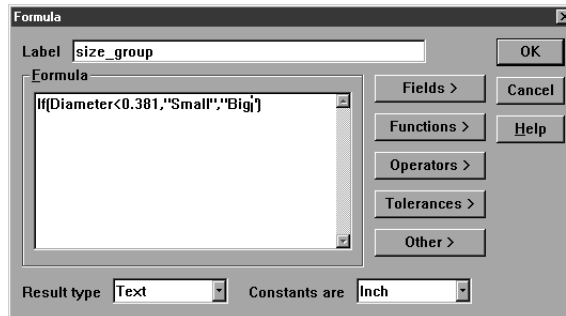

Step 3  
Type in the modification.

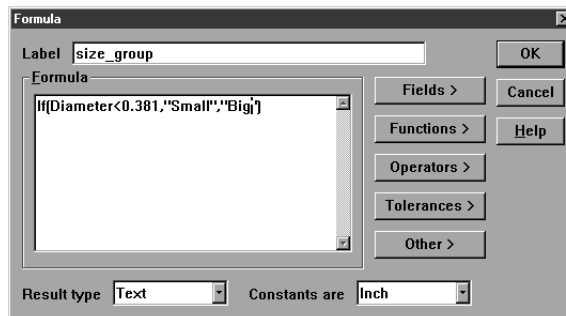

Step 4  
Click OK in the formulas dialog box.

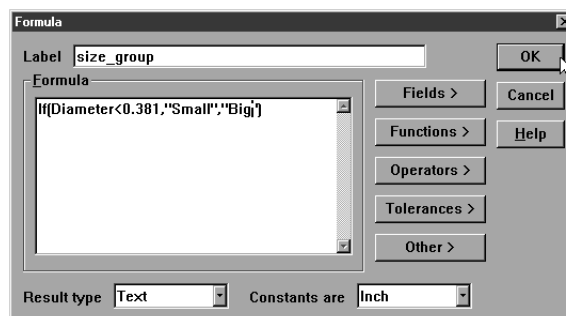

Step 5

Click OK in the column properties dialog box.

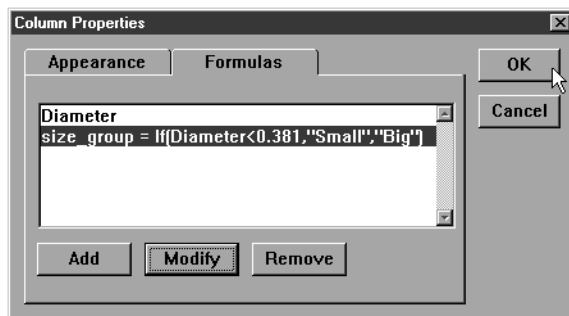

**To remove a formula**

Step 1

Highlight the desired formula in the text box on the formula tab (column properties dialog box).

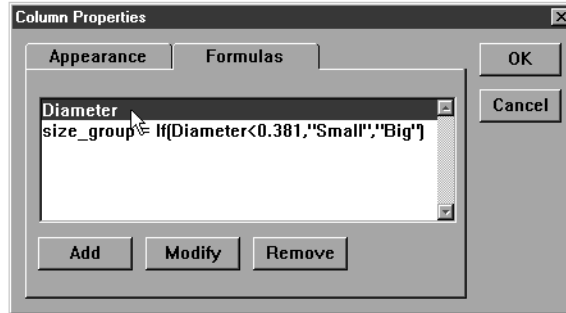

Step 2

Click the *remove* button.

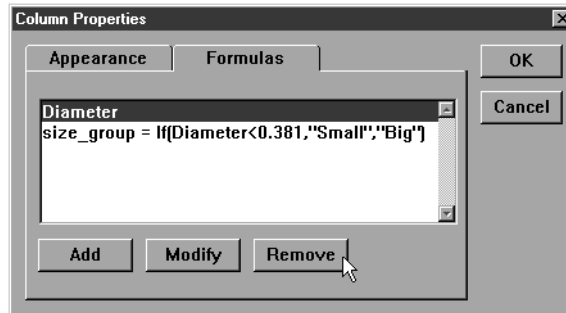

Step 3

Click *yes* in the dialog box.

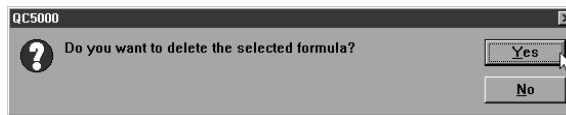

### Runs Template

Use the runs template to track critical features from one program run to the next. Data in the runs is restricted to one feature attribute per column. For example, a column may display only the 'x' value for a given circle.

#### To open the runs template

##### Step 1

Select *open template* from the windows menu.

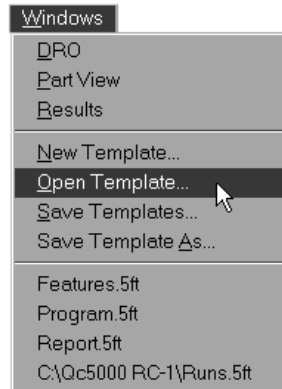

##### Step 2

Select *runs.5ft* from the file name list in the open template dialog box.

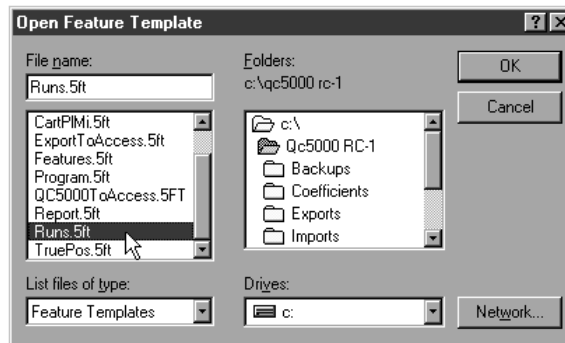

##### Step 3

Click OK in the dialog box.

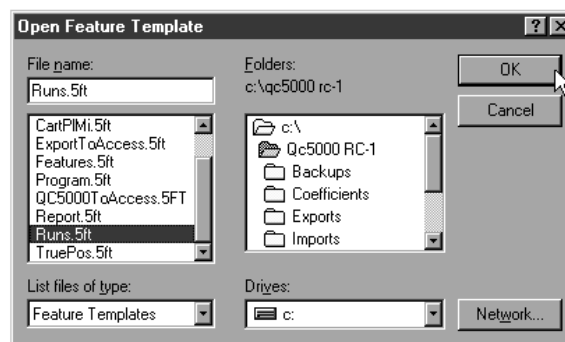



**To add data to the runs template**

**Step 1**

Highlight a feature in the features list.

I	T	Name	Datum	X	Y	Z	d	r
○		Circle 7		2.99938	0.49964	-0.00901	0.37484	0.187
○		Circle 5		3.00058	2.49767	-0.03907	0.37424	0.187
○		Plane 1	Primary	3.21868	1.62520	0.00000		
○		Point 4	Zero	0.00000	0.00000	-0.39125		
○		Line 3		2.17580	-0.00110	-0.39047		

**Step 2**

Click on the desired fields in the results window to highlight them.

Circle 5, from 3 of 3 points

r =	0.18712	d =	0.37424
X =	3.00058	Y =	2.49767
Z =	-0.03907		
F =	0.00000	RF =	Ref #1 PP = XY

**Step 3**

Place the cursor over the highlighted fields and hold down the left mouse button.

Circle 5, from 3 of 3 points

r =	0.18712	d =	0.37424
X =	3.00058	Y =	2.49767
Z =	-0.03907		
F =	0.00000	RF =	Ref #1 PP = XY

**Step 4**

Drag the fields into the runs template.



The new fields appear in the template as shown.

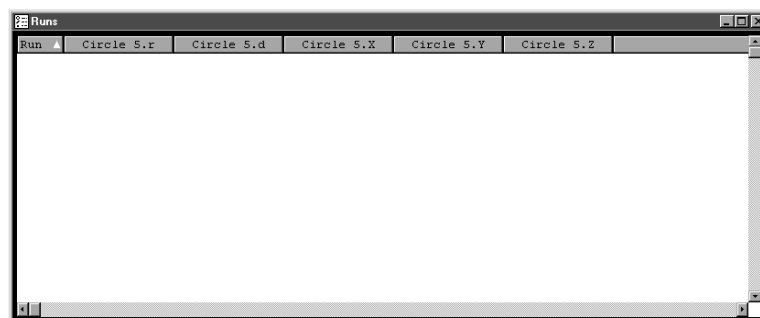

### Nesting Template Windows

Up to ten can be open at one time. Nest templates within a single window to organize the desktop. Use the tabs to view nested windows.



#### NOTE

**Do not open unneeded templates. System speed decreases as more templates are opened. Use the minimum number of templates required for fastest processing.**

#### To nest template windows

##### Step 1

Place the cursor over the title bar of the template window.

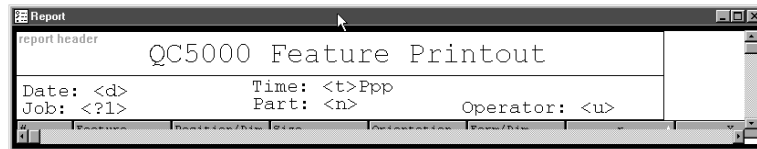

##### Step 2

Hold down the left mouse button and drag the window another template window.

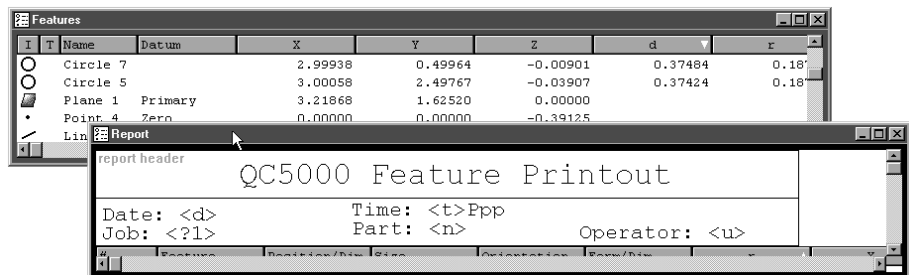

##### Step 3

Release the left mouse button.

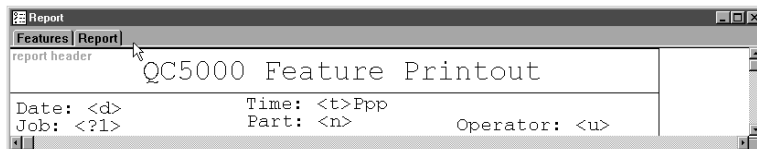

#### To separate template windows

##### Step 1

Place the cursor of the desired template tab.



Step 2

Hold down the left mouse button and drag the template out of the window.

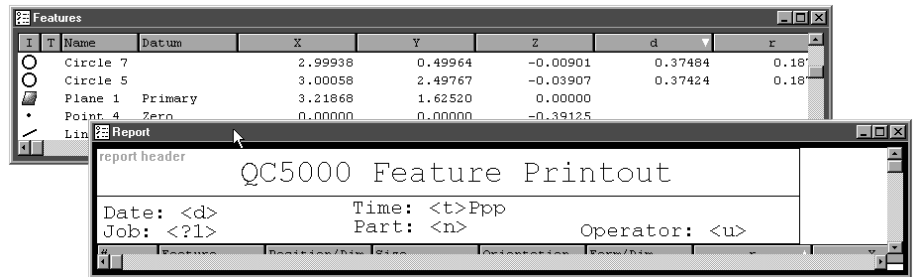

Step 3

Release the mouse button.

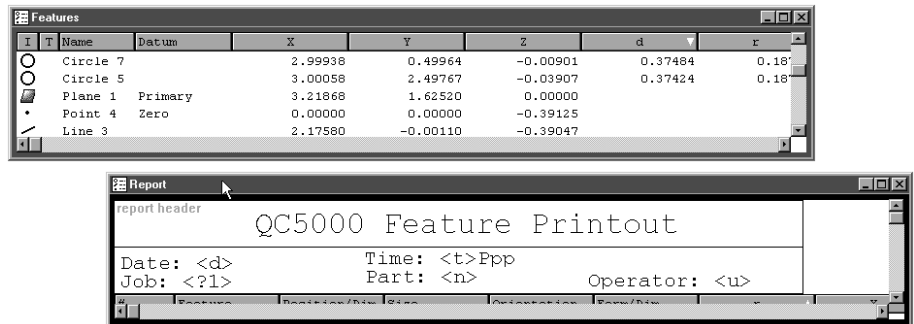

## Chapter 6 Templates

### Creating New Templates

Creating a new template allows you to customize report formats and information in the features list. For example, templates can be designed to export data in a certain format.

#### To create a new template

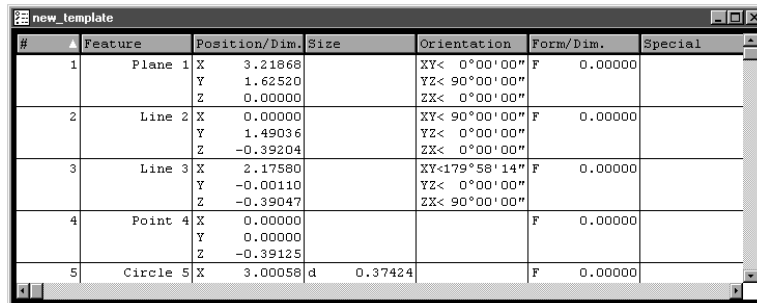

#	Feature	Position/Dim.	Size	Orientation	Form/Dim.	Special
1	Plane 1	X 3.21868 Y 1.62520 Z 0.00000		XY< 0°00'00" YZ< 90°00'00" ZX< 0°00'00"	F 0.00000	
2	Line 2	X 0.00000 Y 1.49036 Z -0.39204		XY< 90°00'00" YZ< 0°00'00" ZX< 0°00'00"	F 0.00000	
3	Line 3	X 2.17580 Y -0.00110 Z -0.39047		XY<179°58'14" YZ< 0°00'00" ZX< 90°00'00"	F 0.00000	
4	Point 4	X 0.00000 Y 0.00000 Z -0.39125			F 0.00000	
5	Circle 5	X 3.00058	d 0.37424		F 0.00000	

#### Step 1

Select *new template* from the windows menu.

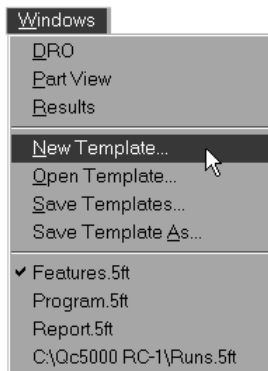

#### Step 2

Type a name for the template in the file name text box.

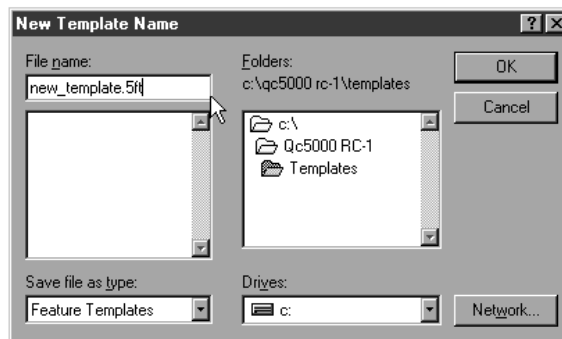

Step 4  
Click OK in the new template name dialog box.

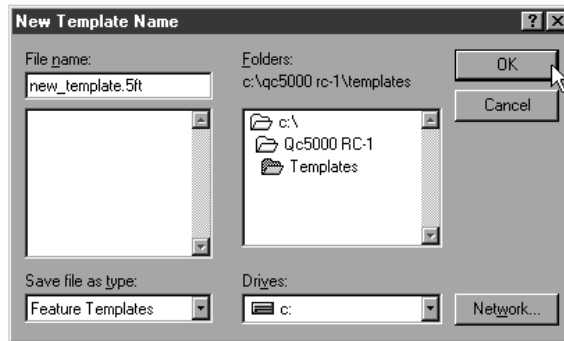

Step 5  
Select type of template to create in the dialog box.

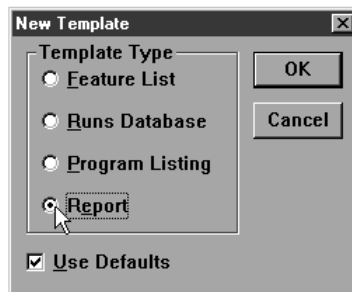

To export a tab delimited file to a spreadsheet

Step 1

Select the features to be exported from the features list.

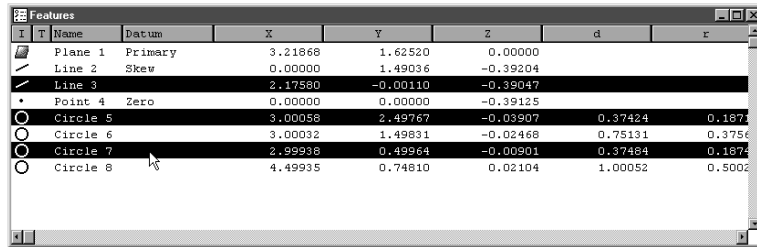

	Name	Datum	X	Y	Z	d	r
Plane 1	Primary		3.21868	1.62520	0.00000		
Line 2	Skew		0.00000	1.49036	-0.39204		
Line 3			2.17580	-0.00110	-0.39047		
Point 4	Zero		0.00000	0.00000	-0.39125		
Circle 5			3.00058	2.49767	-0.03507	0.37424	0.1875
Circle 6			3.00032	1.49631	-0.02468	0.75131	0.3750
Circle 7			2.99938	0.49964	-0.00501	0.37484	0.1875
Circle 8			4.49935	0.74810	0.02104	1.00052	0.5000



NOTE

Hold down the ctrl key to select features that are not listed sequentially in the features list.

Step 2

Select *export* from the file menu.

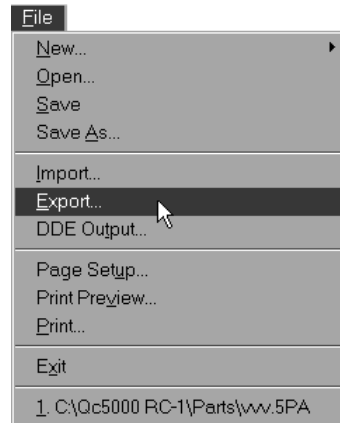

Step 3

Select *tab delimited* from the *save file as type* list in the export dialog box.

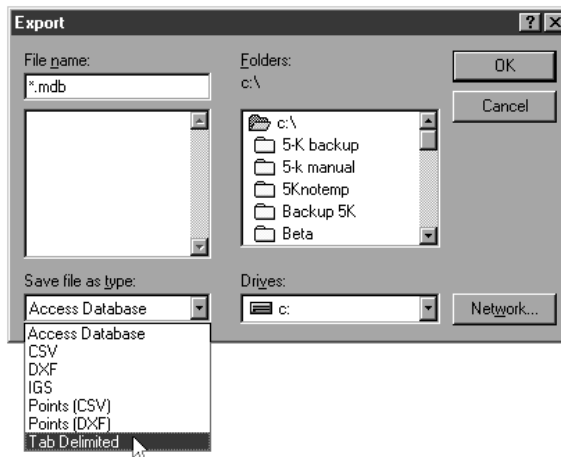

Step 4

Type the name of the file in the file name text box.

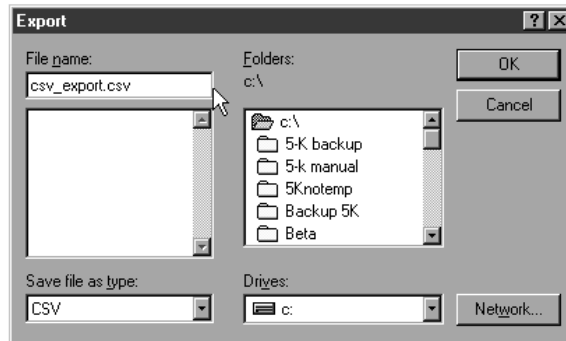

Step 5

Use the *folders* box and drives list to select the storage location for the file.

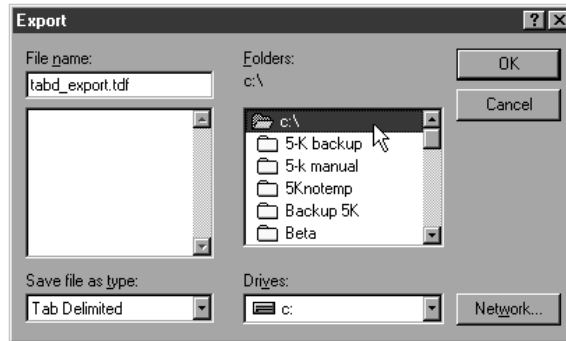

Step 6

Click OK in the export dialog box.

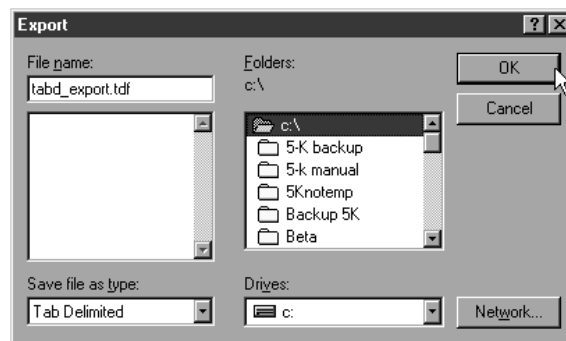

Step 7  
Open the spreadsheet application and open the saved file.

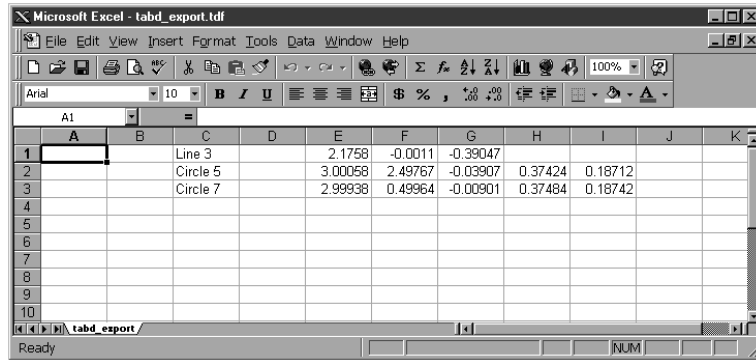

**To export a CSV (comma separated value) file to a spreadsheet**

Step 1  
Select the features to be exported from the features list.

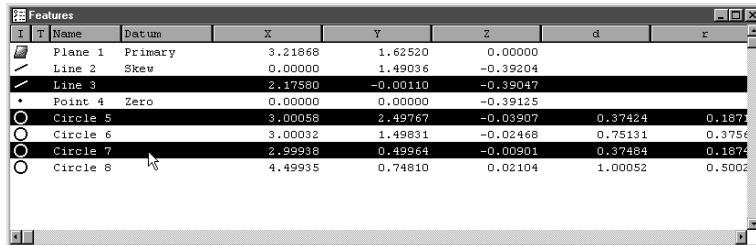

**NOTE**

Hold down the ctrl key to select features that are not listed sequentially in the features list.

Step 2  
Select *export* from the file menu.

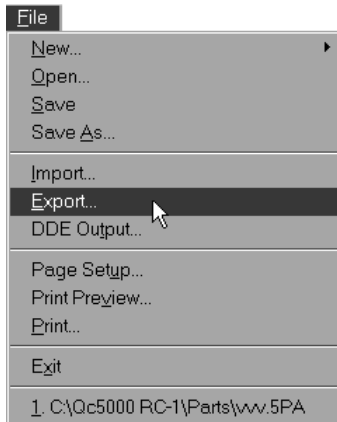



Step 3

Select *CSV* from the save file as type list in the export dialog box.

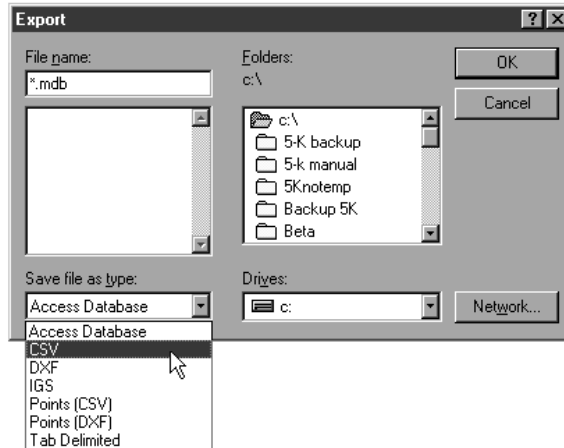

Step 4

Type the name of the file in the file name text box.

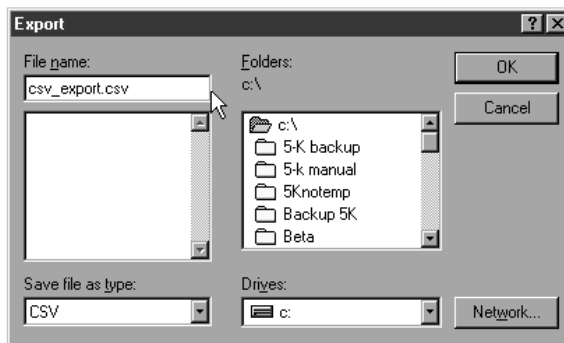

Step 5

Use the *folders* box and drives list to select the storage location for the file.

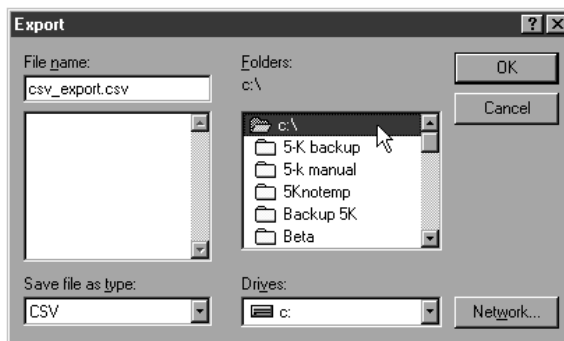

Step 6  
Click OK in the export dialog box.

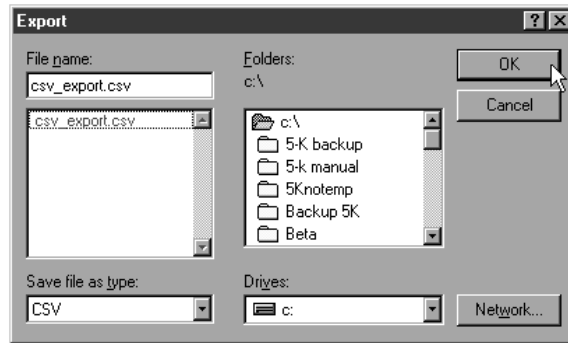

Step 7  
Open the spreadsheet application and open the saved file.

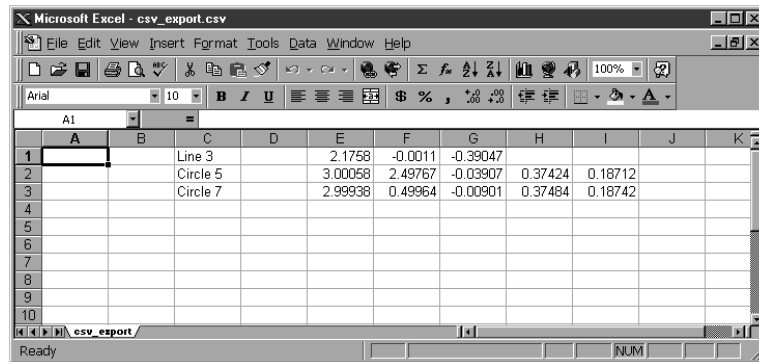

# Chapter 7

## Programming

---

The QC5000 is user programmable. Users can enter a series of steps and save it as a program for later use. When the program is executed the QC5000 prompts the user to perform the necessary steps for the inspection of the part. This function is useful for repetitive measuring of large quantities of parts. QC5000 programs are part specific, that is each program is for a specific part. A sample program and instructions to create it are included in this chapter.

### Programming Overview

The QC5000 programming feature works like a tape recorder. The following sections explain programming features and demonstrate how to create, save, and run a program. To avoid confusion, use the QC5000 demo part for the following sections. Any multi-feature part may be substituted in later programs.

Keep in mind that QC5000 programs execute sequentially. If a step references a feature, that feature must already be measured. Here are two simple tips for hassle free programming:

- Only reference features that have been measured prior to the step that references them.
- Do not delete a features that are part of a construction.

#### NOTE

**In this section all instructions refer to the program toolbar. The same procedures can be performed using the pull down menus at the top of the screen as well.**

#### NOTE

**Toolbars in the QC5000 software can be customized. This manual attempts to display the most common toolbar arrangements. Some users may find the toolbar setup on their system varies from those shown here.**

## Chapter 7 Programming

### The Program Toolbar

To display the program toolbar select 'toolbars' from the View pull down menu. In the Toolbars dialog box, click on 'program' in the list box on the left then click the Show button. Click the OK button to continue.

#### Record/Edit Program



Click the record/edit button to start recording a program. The QC5000 software will record all actions from this point as a new program or as an addition to an existing program. To stop recording, click the Pause Program button (see below).

#### Pause Program

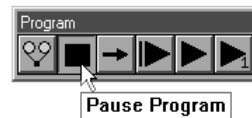

Click the Pause Program button to stop a currently running program or to stop recording/editing a program. The last step executed before the program was paused is highlighted in the program window.

#### New Run

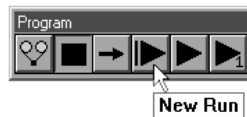

Click the New Run button to run a program from the first step. When New Run is clicked the program begins from the first step regardless of the step selected in the program window.

#### Run Program From Current Step



Click the Run Program From Current Step button to run a program from the currently selected step in the program window.

#### Run Just Current Step

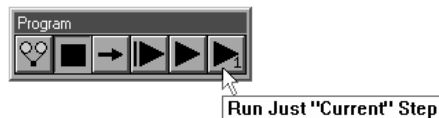

Click the Run Just Current Step to execute only the currently selected step and then pause the program.

## Recording a Program

### To create a program

#### Step 1

Select *new* from the file menu. Then select *part*.

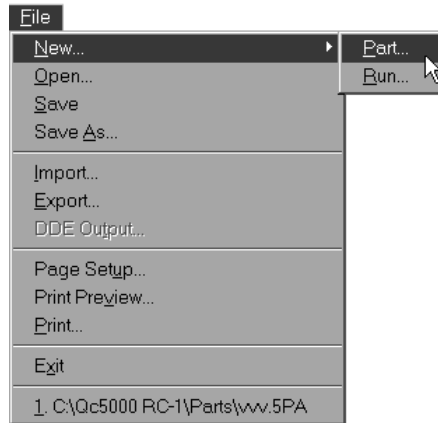

#### Step 2

Click the *record/edit* button on the program toolbar.



#### Step 3

Type a program name as shown.

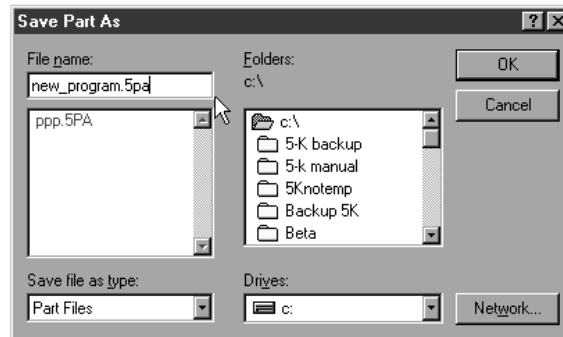

## Chapter 7 Programming

---

Step 4  
Click OK.

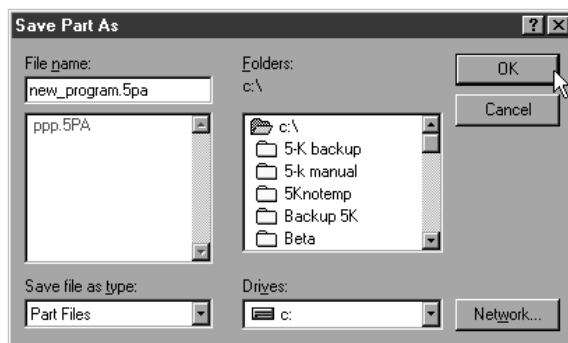

Step 5  
Perform the desired steps.

**To open a saved program**

**Step 1**

Select *open* from the file menu.

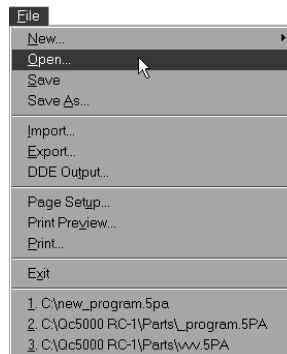

**Step 2**

Highlight the desired program as shown.

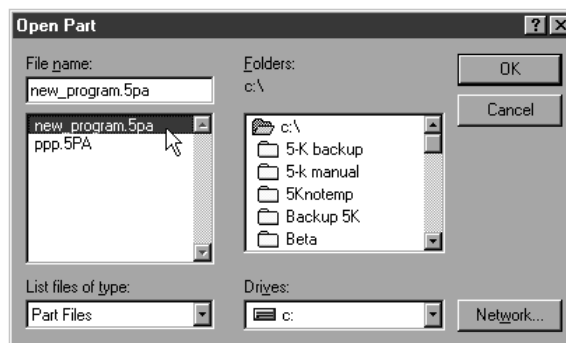

**Step 3**

Click the OK button.

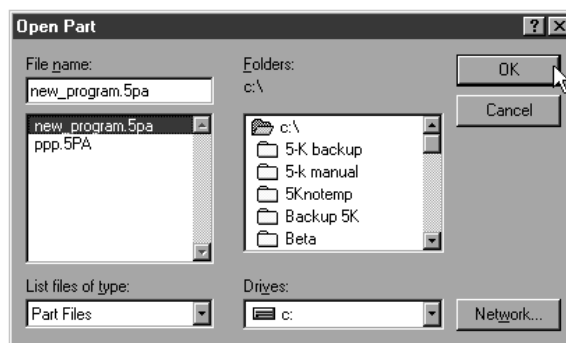

## Chapter 7 Programming

### Running A Program

Running a saved program is easy. Open the part file using the method shown in above.

#### To run a program

Step 1

Select *new* from the file menu.

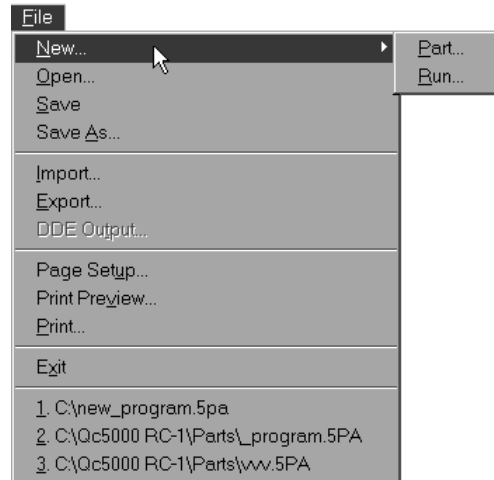

Step 2

Select *run* from the sub-menu.

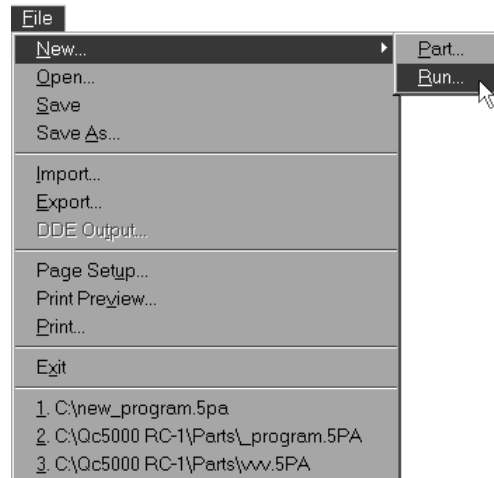

OR

Step 1

Click the *new run button* on the program toolbar.

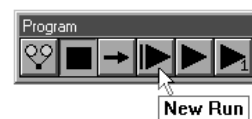



## Sample Program

The following demonstration shows the entire programming process from start to finish. Use the QC5000 demonstration part to avoid confusion, but a program for any multi-feature part can be made with this method. This program will prompt the user to:

- Construct a circle
- Construct a pierce point
- Measure three dimensional features (cylinder and cone)
- Measure two dimensional features (circles and planes)
- Perform a True Position on a circle
- Perform a perpendicularity tolerance
- Perform a width tolerance
- Enter a conditional statement
- Enter a label

Follow the steps straight through to avoid confusion. Each procedure in the program is described in detail elsewhere in this manual. For more information on a particular step consult the index.

### To record the sample program

#### Step 1

Click the *record/edit* button on the program toolbar.



#### Step 2

Type a name for the program as shown.

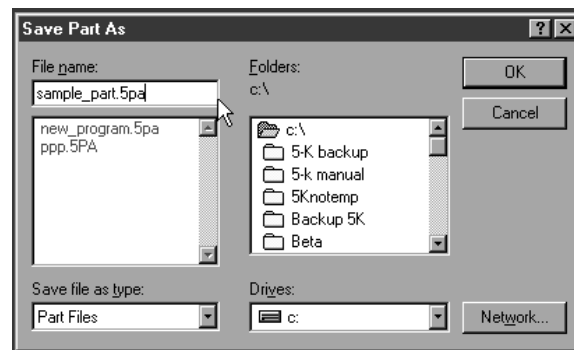

#### Step 3

Click OK in the dialog box.

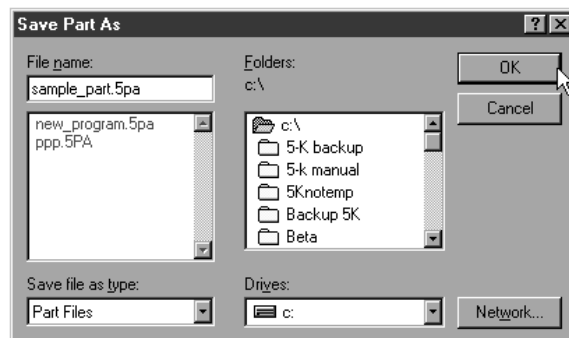

## Chapter 7 Programming

Step 4

Click the *datum magic button* on the datum toolbar.



- create the primary plane

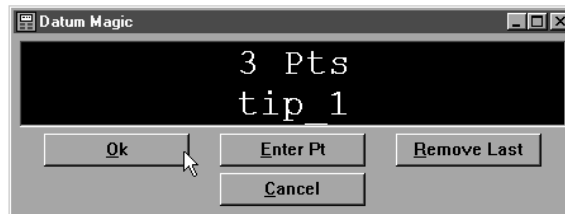
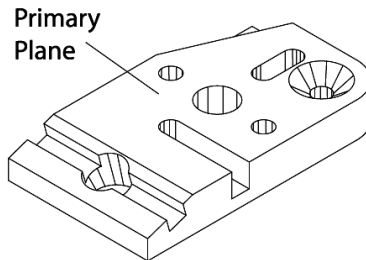

- create the secondary line

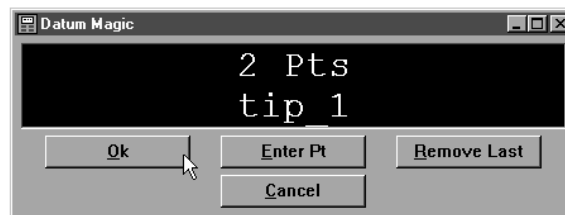
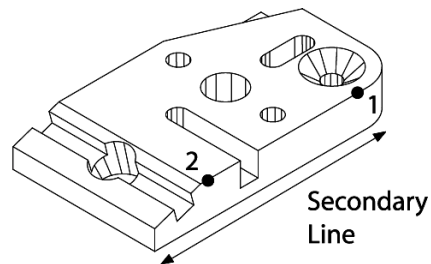

- create the zero point

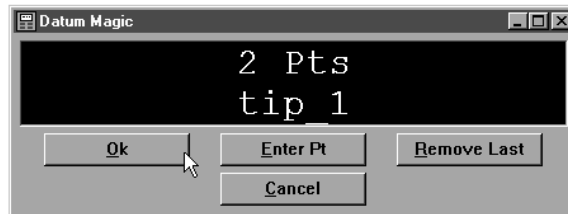
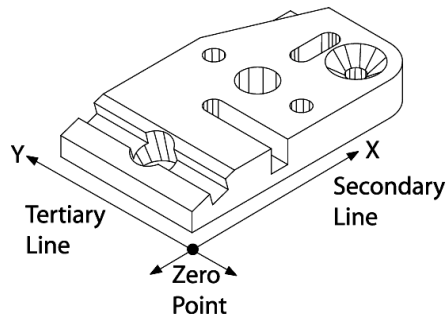

Step 5  
Click the *cone* button on the measure toolbar.

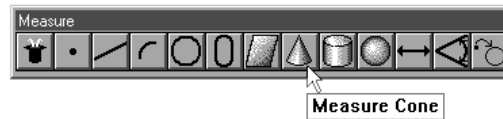

- measure the cone using 9 points

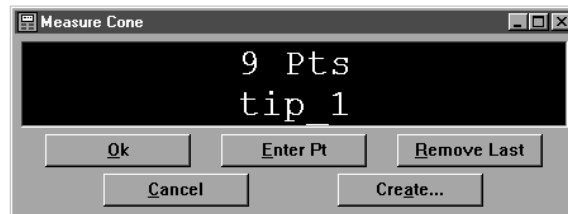

Step 6  
Click the *cylinder* button on the measure toolbar.



- measure the cylinder using 9 points

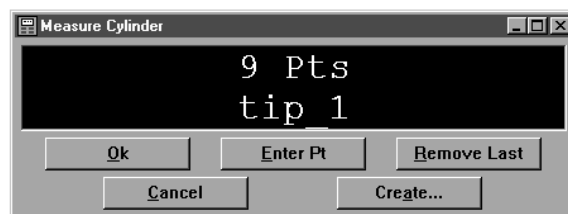

## Chapter 7 Programming

Step 7

Click the *plane button* on the measure toolbar.

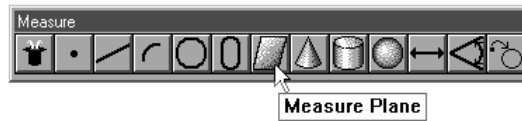

- measure the plane using 6 points

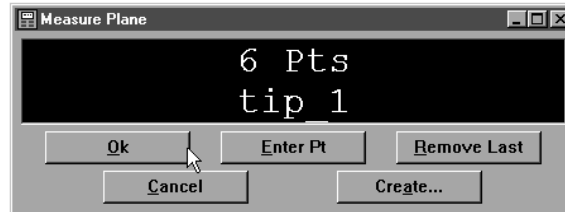

Step 8

Click the *circle button* on the measure toolbar.

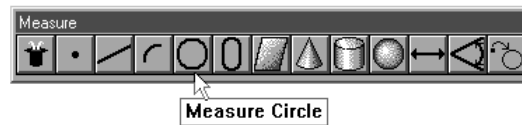

- measure the circle using 6 points

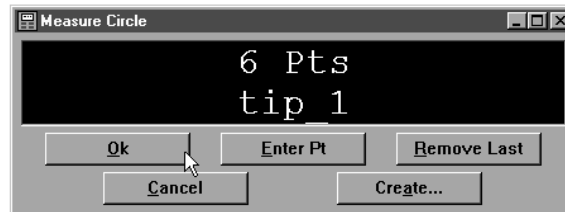

Step 9

Click the *circle button* on the measure toolbar.

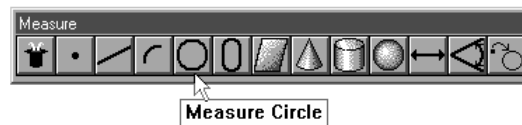

- measure the circle using 6 points

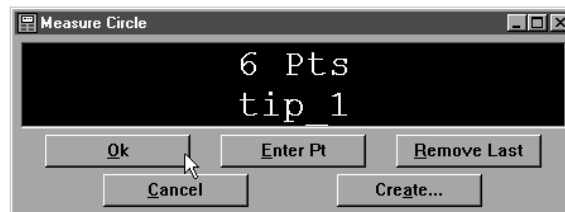

Step 10

Click the *circle button* on the measure toolbar.

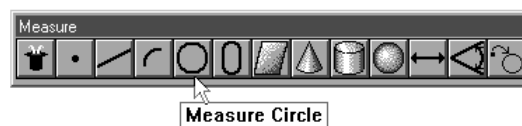

- measure the circle using 6 points

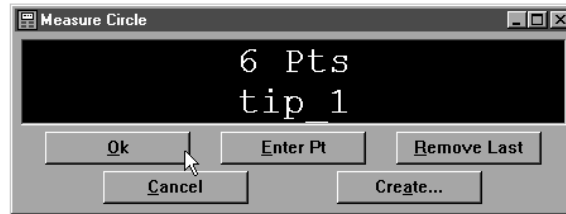

Step 11

Construct a center-to-center distance between the circles 8 and 9.

- Highlight circles 8 and 9 in the features list

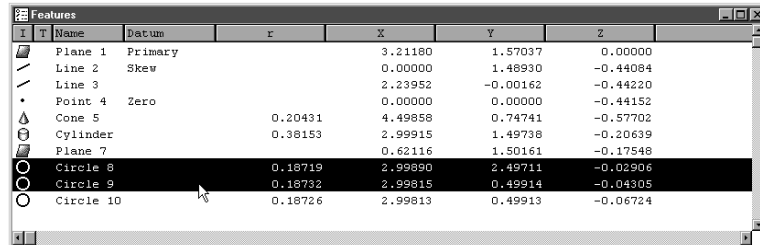

- Click the measure distance button on the measure toolbar



- Click OK in the dialog box

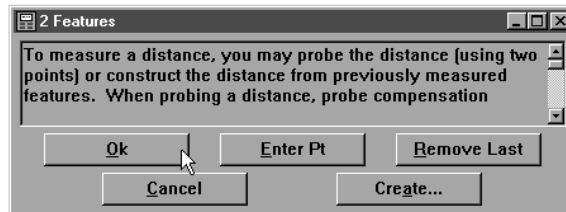

Step 12

Construct a point from the cylinder and the primary plane.

- Highlight the cylinder and the primary plane in the features list

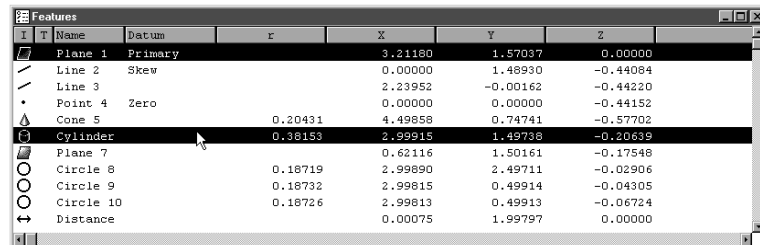

- Click the point button on the measure toolbar



- Click OK in the dialog box

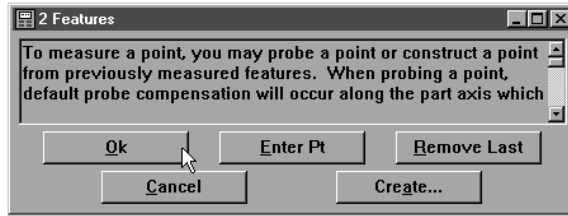

Step 13

Construct an angle between the primary plane and plane 7.

- Highlight the primary plane and plane 7 in the features list

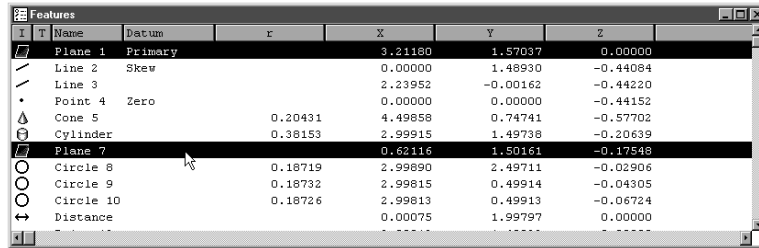

- Click the angle button on the measure toolbar



- Click OK in the dialog box

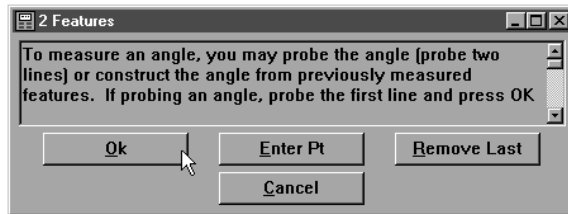

Step 14

Enter a true position tolerance for circle 8.

- highlight circle 8 in the features list

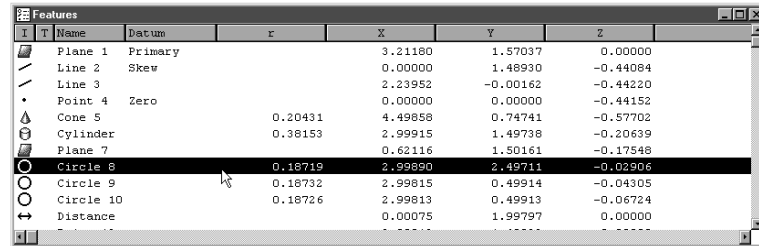

- click the true position/MMC/LMC button on the tolerance toolbar



- enter the tolerance data as shown

The dialog box is titled "True Position Tolerance Entry". It has two main sections: "Position" and "Size".

**Position Section:**

- Buttons: X, Y, Z
- Fields: X (3.00000), Y (2.50000), Z (-0.02906)
- Label: Tol. Dia. (0.06000)

**Size Section:**

- Buttons: R
- Fields: Nominal (0.18750), Nom - (0.006), Nom + (0.006)

Buttons on the right: OK, Cancel, Delete.

- Click OK

This is the same dialog box as above, but the mouse cursor is pointing at the OK button.

- Click OK in the tolerance results window

The dialog box is titled "True Position Tolerance Results". It shows the results of the tolerance check.

**Position Section:**

	Nominal	Actual	Error Dia.	Tol. Dia.	
X	3.00000	2.99890			
Y	2.50000	2.49711	0.00618	0.06000	P
Z	-0.02906	-0.02906			

**Size Section:**

	Nominal	Actual	Deviation	Low limit	High limit	
R	0.18750	0.18719	-0.00031	0.18150	0.19350	P

Buttons on the right: OK, Edit...

Step 15

Enter a width tolerance for the distance.

- highlight the distance in the features list

I	T	Name	Datum	r	X	Y	Z
		Cone 5		0.20431	4.49858	0.74741	-0.57702
		Cylinder		0.38153	2.99915	1.49738	-0.20639
		Plane 7			0.62116	1.50161	-0.17548
		Circle 8		0.18719	2.99890	2.49711	-0.02906
		Circle 9		0.18732	2.99815	0.49914	-0.04305
		Circle 10		0.18726	2.99813	0.49913	-0.06724
		Distance			0.00075	1.99797	0.00000
		Point 12			2.99813	1.49833	0.00000
		Angle 13		0.48437			

## Chapter 7 Programming

- click the *width* button on the tolerance toolbar

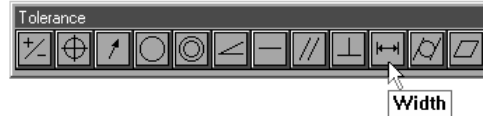

- enter the tolerance data as shown

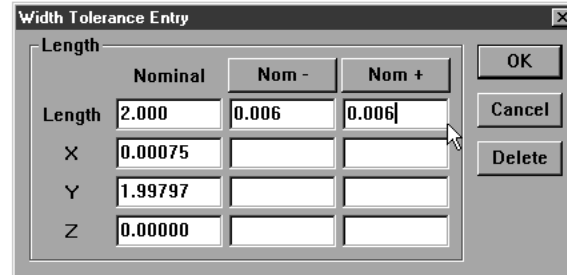

- click OK

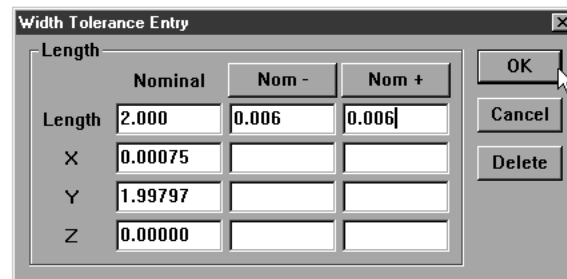

- click OK in the tolerance results window

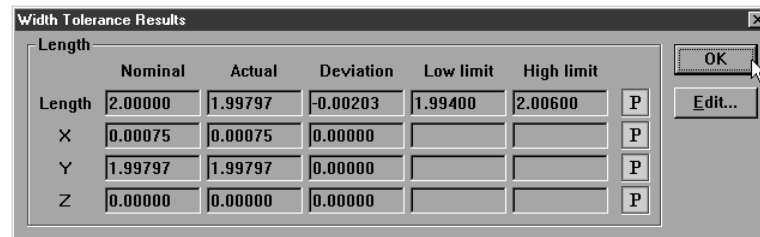

### Step 16

Enter a perpendicularity tolerance for the primary plane.

- highlight the primary plane in the features list

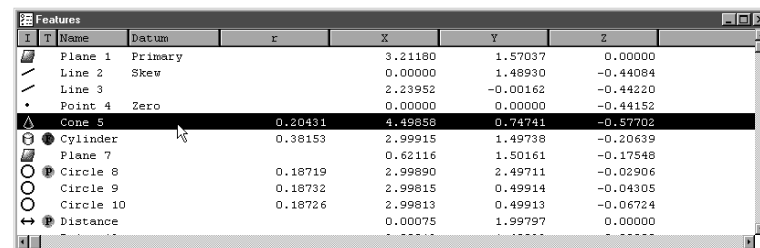

- click the *perpendicularity* button on the tolerance toolbar

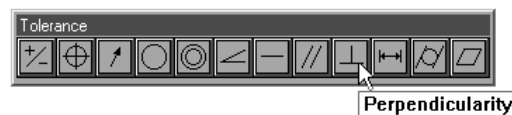



- enter the tolerance zone (0.008 inches) as shown

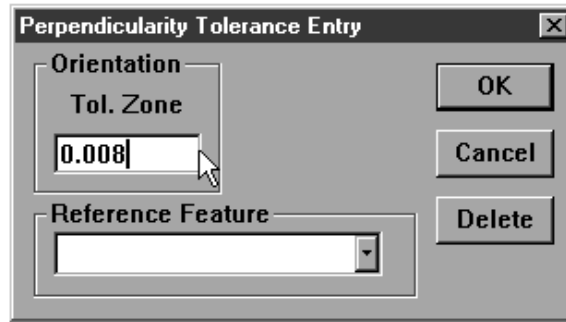

- select the cylinder from the reference feature list

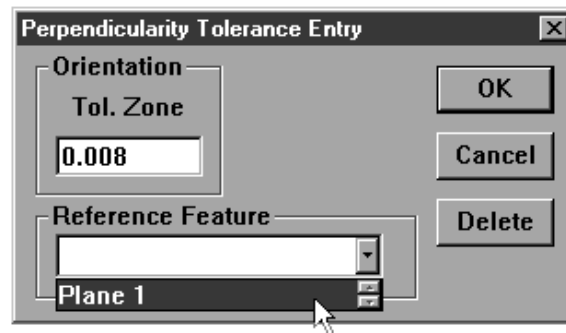

- click OK

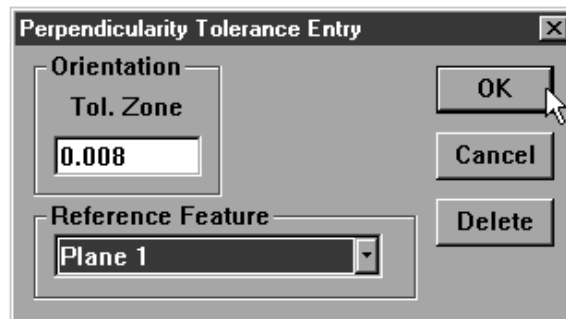

- click OK in the tolerance results window

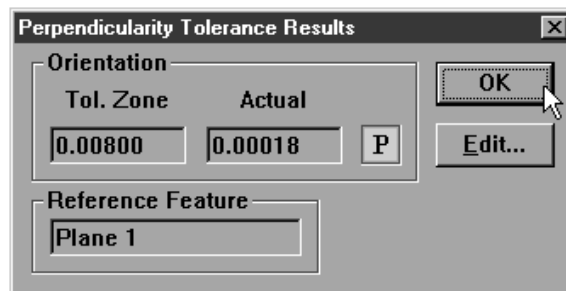

## Chapter 7 Programming

### Creating User Messages

A user message is an onscreen message that is a part of a program. For example, it may be useful to remind an operator to check a certain feature in a particular way. To do this you might insert the message "Make sure to take points clockwise from the left." User messages can say anything, even "Have a nice day."

#### To Insert A User Message

##### Step 1

Select *programming* then *special steps* then *user message* from the tools menu.

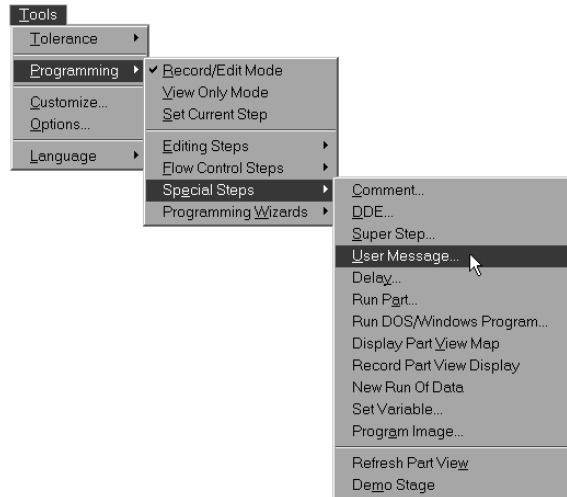

##### Step 2

Type the desired message as shown.



##### Step 3

Click OK in the dialog box.

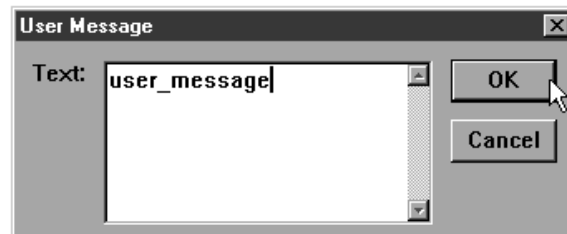

## Expanding the Program Toolbar

This section describes buttons commonly added to the program toolbar by QC5000 users. A procedure for adding buttons to a toolbar follows this section.

### Toggle Break Point

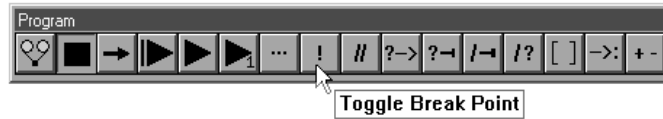

Click the Toggle Break Point button to attach a marker to the currently selected step. A marker instructs the program to stop at a step in the program. To remove a marker, select the step with the marker and click the Toggle Break Point button. Markers can be placed on more than one step within a program.

### Program Comment

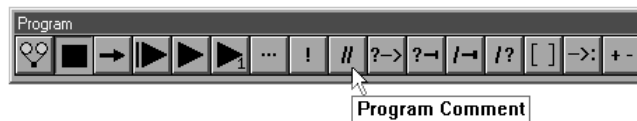

Click to enter a note into the program for future reference. Program comments are simply to explain a step or add information that might help later. Comments do not perform functions.

### Edit Steps



Click the Edit Steps button to edit the currently selected step. The options presented depend on which functionality is associated with the currently selected step. For example, if the current step is .... the following options are presented, ...

### If-Goto



Click to place an If-Goto statement in a program, see the Conditional Statements section for more information.

### If-Then



Click to place an If-Then statement in a program, see the Conditional Statements section for more information.

**Else**



Click to place an Else statement in a program, see the Conditional Statements section for more information.

**Else-If**

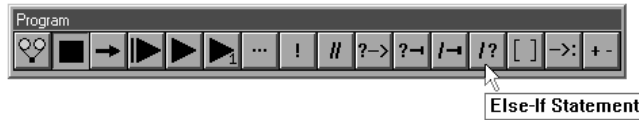

Click to place an Else-If statement in a program, see the Conditional Statements section for more information.

**Super Step**

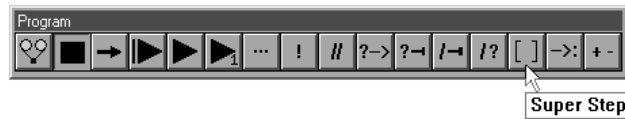

Click to group a selection of steps into a collapsible group (SuperStep). This organizes and shortens the display of large programs in the Program window.

**Goto Label**



Click to create a Goto Label for use with an If- Goto conditional statement. The Goto Label is the action carried out if the test condition is true.

**Offset Positions**

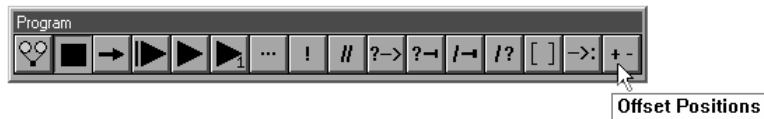

Click to manually enter a coordinate that will offset the current coordinate. This feature is useful for inspecting multiple parts mounted on a fixtured Program Toolbar

This section describes other buttons that users commonly place on the program toolbar. A procedure for adding buttons to the toolbar follows this section.

**Toggle Break Point**

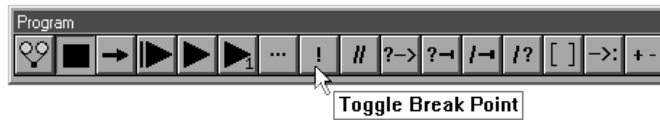

Click the Toggle Break Point button to attach a marker to the currently selected step. A marker instructs the program to stop at a step in the program. To remove a marker, select the step with the marker and click the Toggle Break Point button. Markers can be placed on more than one step within a program.

### Program Comment

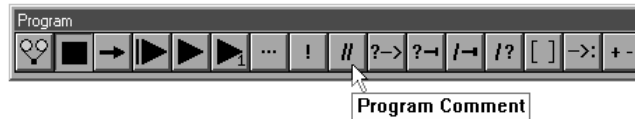

Click to enter a note into the program for future reference. Program comments are simply to explain a step or add information that might help later. Comments do not perform functions.

### Edit Steps



Click the Edit Steps button to edit the currently selected step. The options presented depend on which functionality is associated with the currently selected step. For example, if the current step is .... the following options are presented, ...

### If-Goto



Click to place an If-Goto statement in a program, see the Conditional Statements section for more information.

### If-Then



Click to place an If-Then statement in a program, see the Conditional Statements section for more information.

### Else



Click to place an Else statement in a program, see the Conditional Statements section for more information.

### Else-If



Click to place an Else-If statement in a program, see the Conditional Statements section for more information.

**Super Step**



Click to group a selection of steps into a collapsible group (SuperStep). This organizes and shortens the display of large programs in the Program window.

**Goto Label**

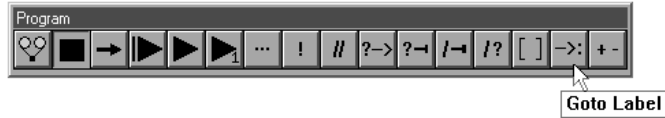

Click to create a Goto Label for use with an If- Goto conditional statement. The Goto Label is the action carried out if the test condition is true.

**Offset Positions**

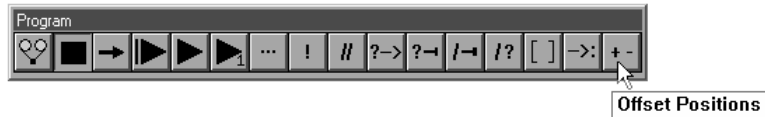

Click to manually enter a coordinate that will offset the current coordinate. This feature is useful for inspecting multiple parts mounted on a fixture.

To add buttons to a toolbar



Step 1

Select *customize* from the tools down menu.



Step 2

Select the *toolbars* tab.



Step 3

Highlight the desired toolbar as shown.

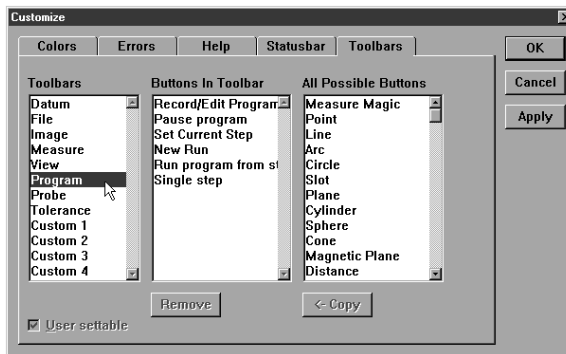

## Chapter 7 Programming

### Step 4

Click on the desired button in the *all possible buttons* list.

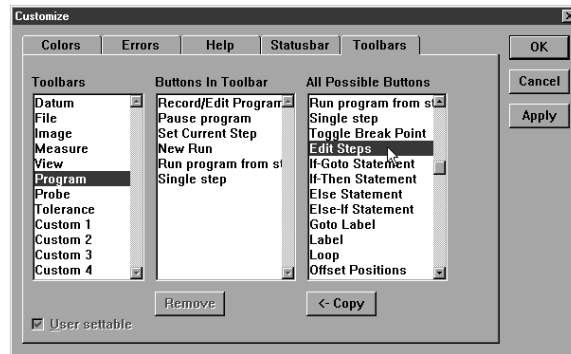

### Step 5

Click the *copy* button.

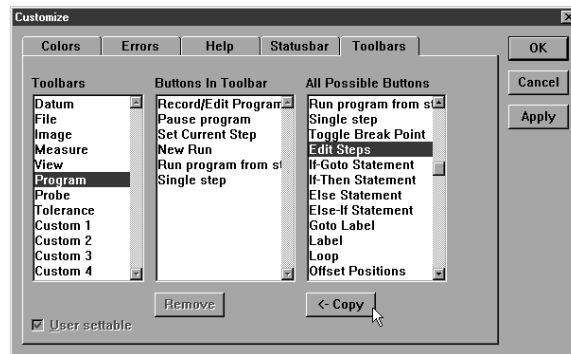

### Step 6

Click OK.

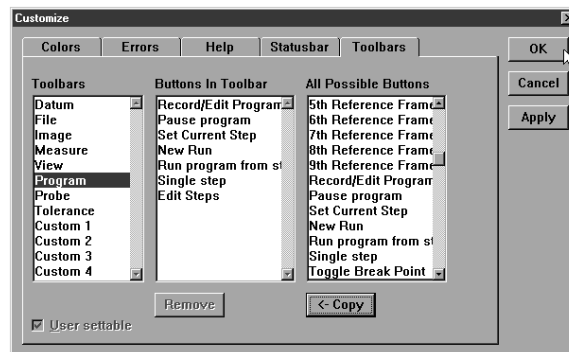

The new button appears in the toolbar.





**To delete buttons from a toolbar**



Step 1

Select *customize* from the tools down menu.



Step 2

Select the *toolbars* tab.

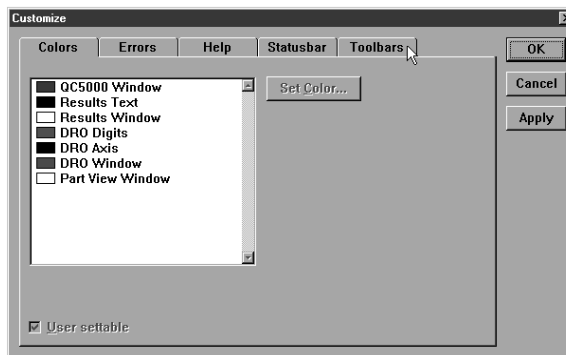

Step 3

Highlight the desired toolbar as shown.

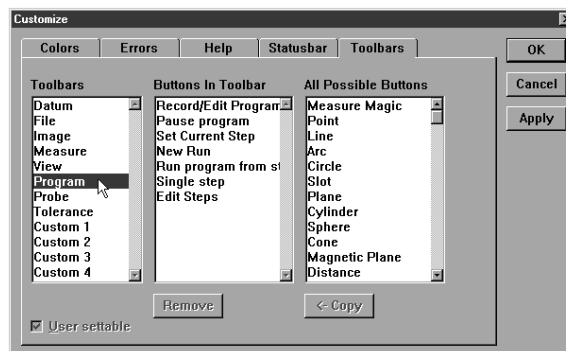

## Chapter 7 Programming

### Step 4

Click on the desired button in the *buttons in toolbar* list.

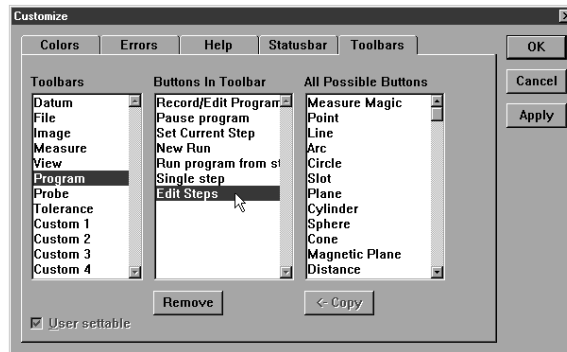

### Step 5

Click the *remove* button.

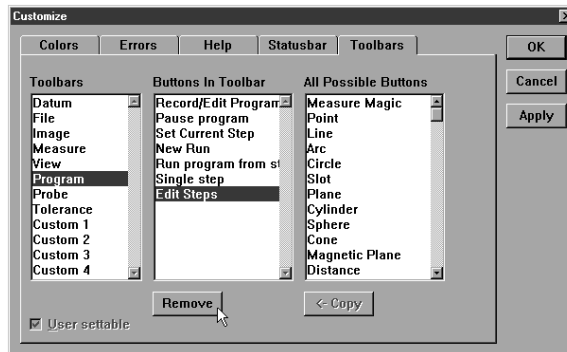

### Step 6

Click OK.

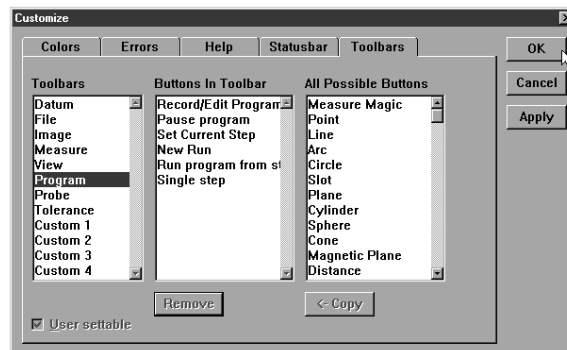

The button is removed from the toolbar.



## Conditional Statements

Conditional statements can be a handy way to handle many inspection tasks. For example, if a feature fails to meet specifications a conditional statement can stop the inspection or require a second inspection. A conditional statement can also check that a feature is within a tolerance by using arithmetical operators (more on this later).

The two basic elements of a conditional statement are the test condition and the action. Essentially conditional statements check the test condition and then do something if the test condition is true and something else if it is false.

### Test Conditions

Test conditions are the inspected feature of the part and any arithmetical operations required by the user. If that seems a bit complex take a look at the conditional statement below.

In this example, 'If Input\_1 > 5mm' is the test condition. 'Input\_1' is the inspected feature and '> 5mm' is the arithmetical operation. If you were to read the test condition out loud it would be: If Input\_1 is greater than 5mm. This is the test condition. All that is needed now is an action.

### Actions

Actions are any steps to be carried out by the program or a labeled line. If-Then statements carry out the steps described and If-Goto statements skip to the labeled line. Both types are shown below.

In this example, 'Measure\_1' is the action.

The types of conditional statements used in QC5000 programs are: If-Goto, If-Then, Else, and Else-If. Else and Else-If statements can only be used with an If-Then statement for example: If-Then Else or If-Then Else-If.

**Arithmetic Operators**

Test conditions are essentially mathematical equations. The chart below lists the arithmetical operators used in the QC5000 software.

QC5000 Arithmetic Operators

Operator	Function
+	addition
-	subtraction
*	multiple
/	division
PI	pi =3.14
==	equals
!=	not equal to
>	greater than
<	less than
>=	greater than or equal to
<=	less than or equal to

Arithmetic operators determine what happens in the test condition. Take a look at the following test condition to get a better understanding.

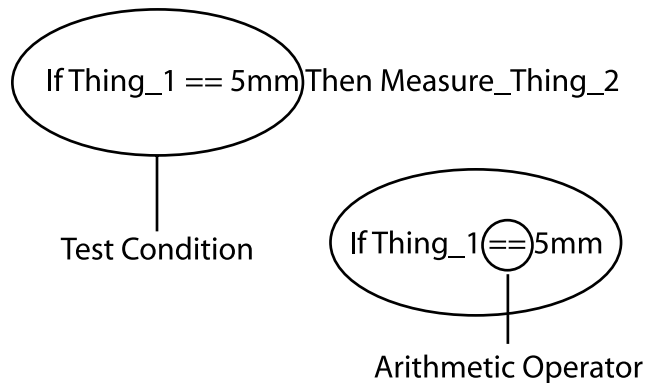

In this example, the '=' arithmetic operator determines that Thing\_1 must equal 5mm for the test condition to be true. The entire test condition reads: if Thing\_1 is equal to 5mm. This means the action Measure\_Thing\_2 will only be carried out if Thing\_1 equals 5mm.

Changing the arithmetic operator changes the entire test condition. For example, if the '=' in the example is changed to '<=' Thing\_1 must be less than or equal to 5mm for the test condition to be true.

**If-Goto Statement**

If-Goto statements check the test condition and, if it is true, go to a labeled line within the program. Use an if-Goto statement to skip ahead in a program if the test condition is true.

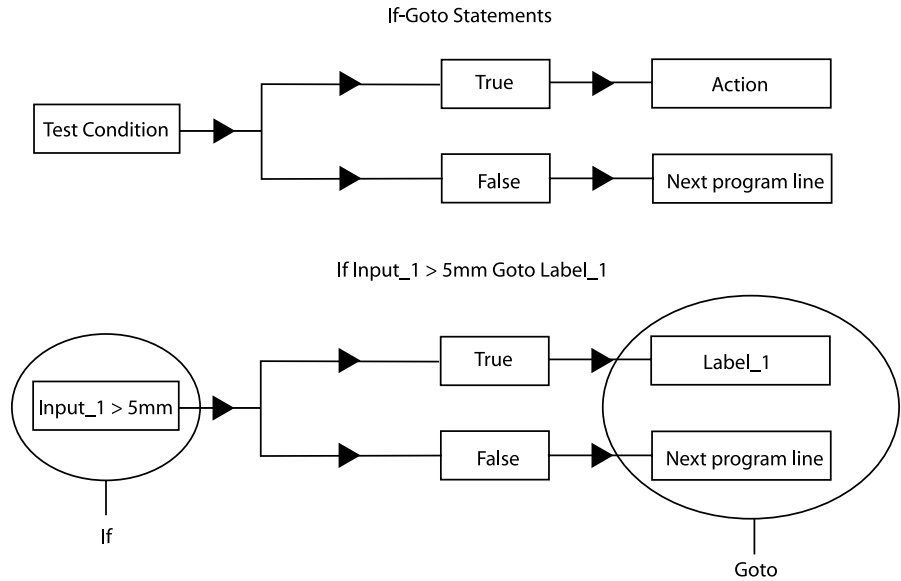

In this example, if the feature measures greater than 5mm the program goes to the line labeled 'Label\_1.'

To place an If-Goto statement in a program, click the If-Goto Statement button in the program toolbar.

**If-Then Statement**

If-Then statements check the test condition and, if it is true, carries out the action and proceeds to the next program line. If the test condition is false the program continues to the next line without carrying out the action.

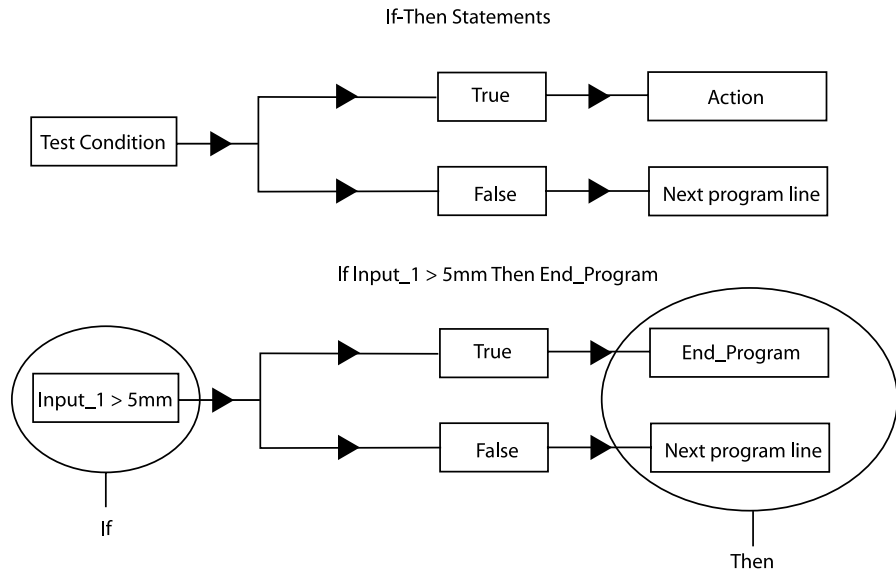

In this example, if the feature measures greater than 5mm the program carries out the action 'End\_Program.' If the feature measures less than 5mm the program continues to the next line.

To place an If-Then statement in a program, click the If-Then Statement button in the program toolbar.

**Else Statement**

Else statements are used in conjunction with an If-Then statement. If the test condition for the If-Then statement is false the program carries out the 'else' action.

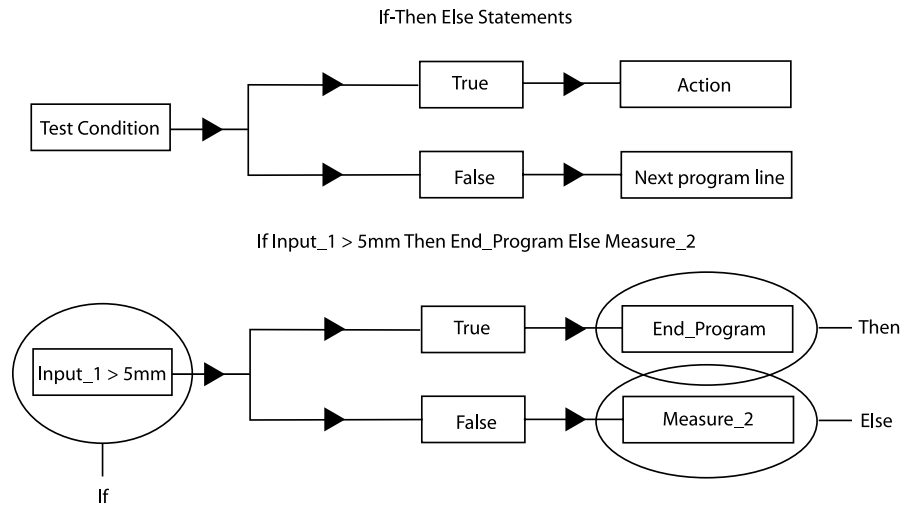

In this example, if the feature measures greater than 5mm the program then carries out the action 'End\_Program.' If the feature measures less than 5mm the program carries out the action 'Measure\_2.'

To place an Else statement in a program, click the Else Statement button in the program toolbar.

**Else-If Statement**

Else-If statements are also used in conjunction with an If-Then statement. If the test condition for the If-Then statement is false the program skips the 'then' action and checks the second test condition. If the second test condition is true the program carries out the second action and if it is false the program continues to the next line.

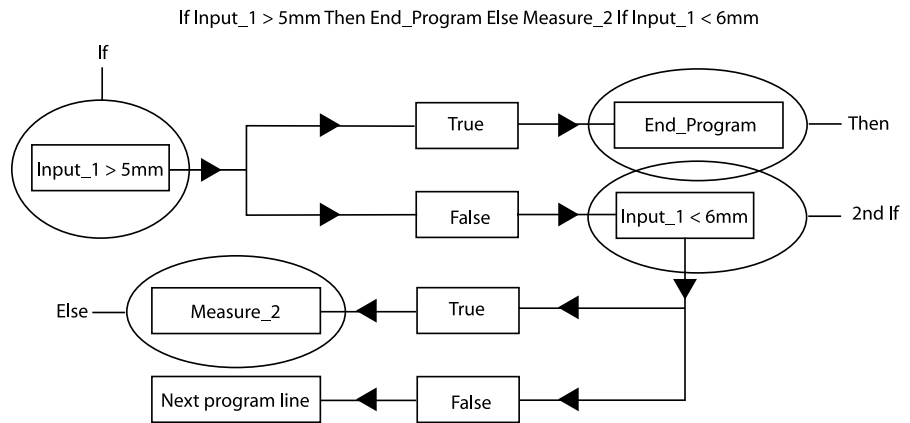
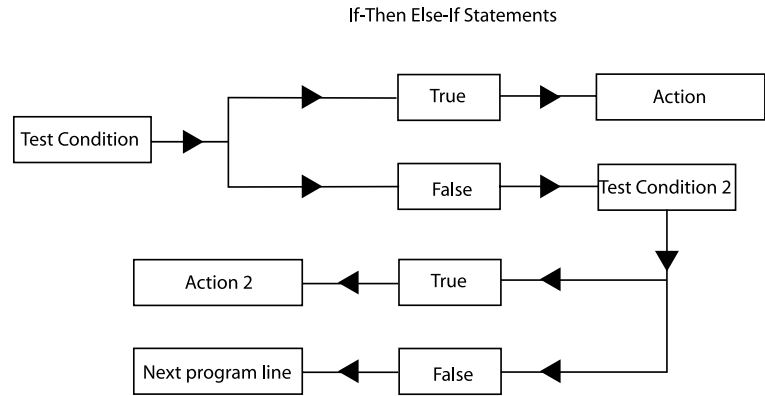

In this example, if the feature measures greater than 5mm the program carries out the action 'End\_Program.' If the feature measures less than 5mm the program checks the second test condition. If the feature measures less than 6mm the program carries out the action "Measure\_2" and if greater than 6mm goes to the next program line.

To place an Else-If statement in a program, click the Else-If Statement button in the program toolbar.



Test conditions are constructed as formulas. Use the following information to help construct useful test conditions.

**Parantheses( )**

Use parantheses to order mathmetical equations. For example, in the following equation

$$6*(4+2) = 36$$

the 4 and 2 are added together before being multiplied by the 6.

The same equation without the parantheses is as follows:

$$6*4+2 = 26$$

Here 6 is multiplied by 4 then added to 2.

Work from the innermost set of parantheses to the outermost set in equations using multiple sets of parantheses.

For example,

$$((4+2)*(4+2)+1) = 37$$

Here the addition in the innermost parantheses is performed first,then the two sums are multiplied and added to 1.



**NOTE**

**The mathematical order of operations is always multiplication, division, addition, subtraction.**

Parantheses can also be used to call functions such a squares, square root, max, min, etc. For example,

$$\text{sqrt}(100) = 10$$

the function (square root) is performed on the number in the parantheses (100).

**Brackets [ ]**

Use brackets to recall previously measured features for a formula. For example,

$$[\text{Circle 1}]x$$

recalls the 'x' value of Circle 1.

A more complex equation might be

$$\text{sqr}([\text{Circle 1}]\text{radius})*\text{PI}$$

Here the radius of Circle 1 is squared and multiplied by pi which produces the area of Circle 1.

### Quote marks ""

Use quote marks to indicate an output in a formula. For example, `If([Circle 1]radius<=2.0,"Small")`

prints the word "Small" in the column if the radius of Circle 1 is less than or equal to 2.0.

A more complex equation might be

**`If([Circle 1]radius<=2.0,"Small","Big")`**

Here the "Small" is printed if the radius of Circle 1 is less than or equal to 2.0 and "Big" is printed if it is greater than 2.0.

Use empty quote marks "" to show no output. For example,

**`If([Circle 1]radius>2.0,"","Small")`**

gives the same output as

**`If([Circle 1]radius<=2.0,"Small")`**

using a slightly different formula.

### Min/Max

Use the min and max functions to find the minimum or maximum parameter for a series of features. For example,

**`Max(-1,-10,"Diameter")`**

will produce the maximum diameter of the last 10 circles measured.





# Chapter 8

## System Setup & Configuration

---

### Before You Begin

You will rarely need to alter settings in the system and encoder setups. The information in this chapter mainly applies to initial setup. It is recommended that system settings be changed only on direction of your dealer or OEM.

#### CAUTION

**Do not change settings in the encoder setup program or supervisor setup options experimentally. Changing these settings can cause serious measurement errors. Contact your dealer or OEM before making an changes to setup functions.**

#### NOTE

**Scale errors cannot be caused by the QC5000. Input from the CMM is read by the software and measurements are performed accordingly. Make certain the CMM is mechanically sound and properly calibrated before installing QC5000.**

### Hardware Setup

Follow the diagram to connect axis and probe cables to the rear of the CPU.

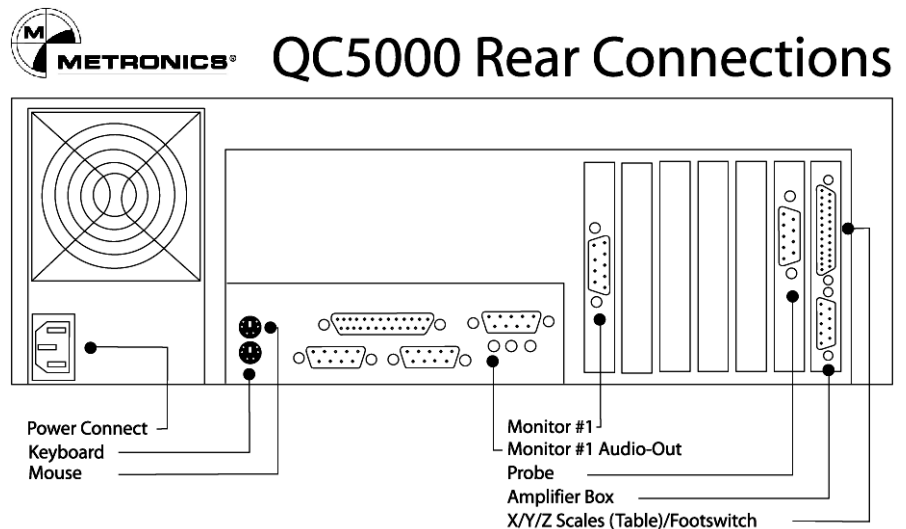

## Chapter 8 Setup Encoder Setup

Use the encoder setup program to detect scale errors and calibrate encoders. Double click on the encoder setup icon to open the program.

### To setup encoders

#### Step 1

Shut down the QC5000

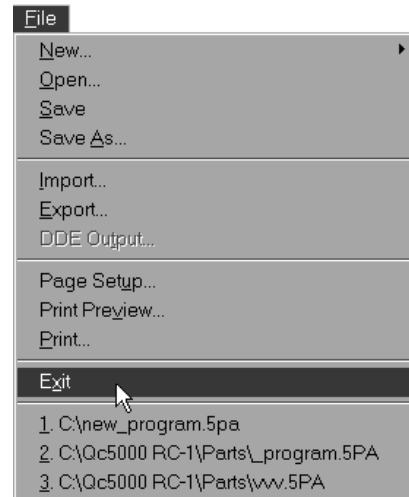

#### Step 2

Double-click the encoder setup icon.



Shortcut to  
Encsetup.exe

#### Step 3

Click OK in the dialog box.

#### Step 4

Select the desired axis as shown.

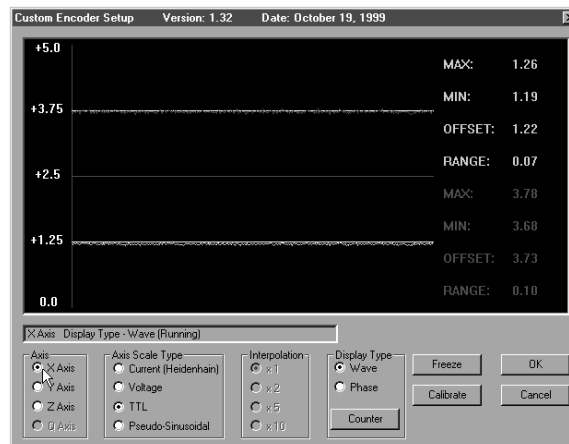

Step 5  
Select the scale type as shown.

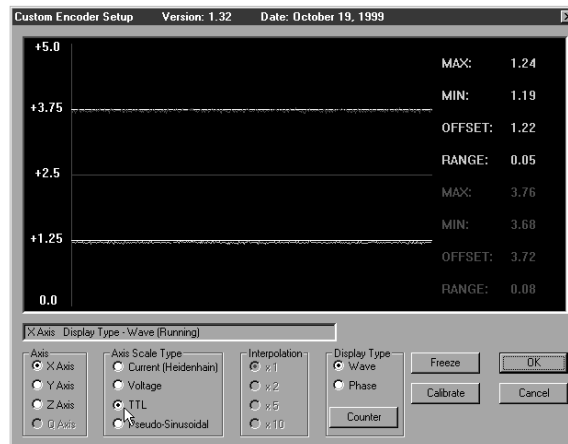

**NOTE**

Consult your distributor/OEM for scale type.

Step 6  
Click the *calibrate* button.

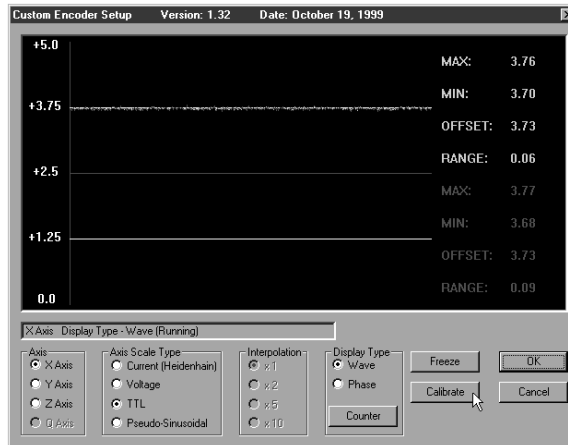

Step 7  
Click OK.



### Step 8

Move the encoder back and forth along the selected axis.

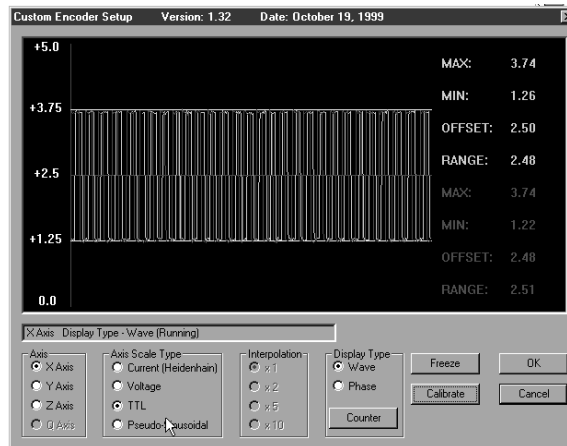

The custom encoder setup window indicates that the calibration is complete and reports the number of scale errors.

### Step 9

Click OK to accept calibration results.

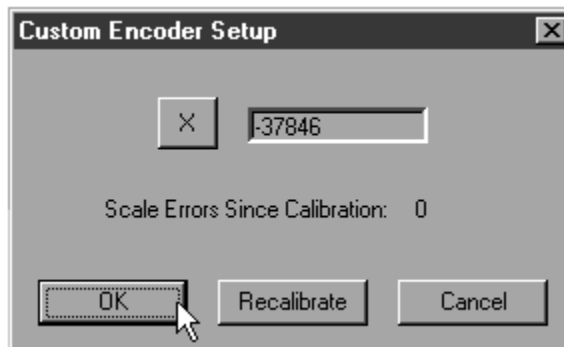

Use the phase mode to determine if the encoder's two waveforms are adjusted to each other. Properly adjusted encoders results in a circle as shown.

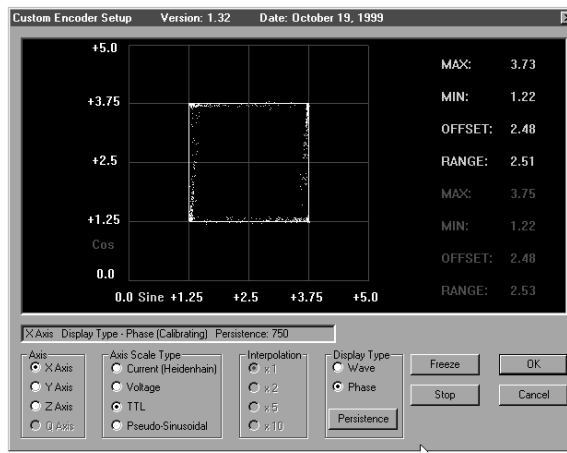



Encoder reader heads may need re-alignment if the wave display appears correct but the phase display does not.

Use the freeze button to freeze the display and examine encoder signals.

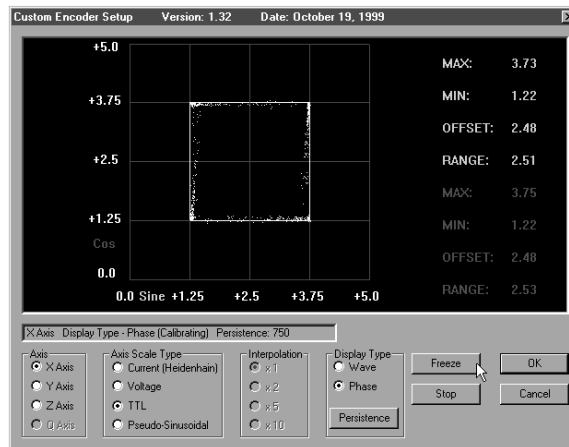

Click the display button to reactivate the display.

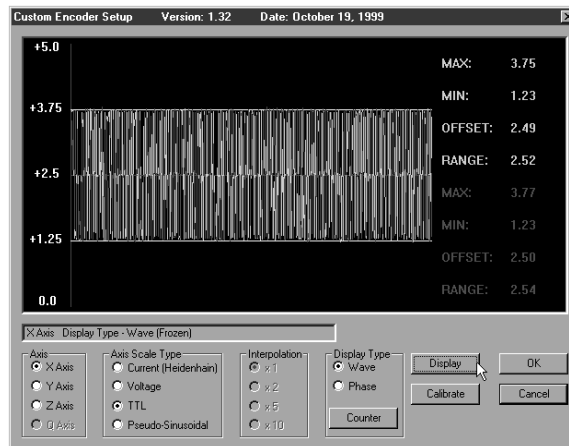

**NOTE**

Do not use the encoder setup program for TTL encoders. Only use the encoder setup program for analog encoders.

**Encoder setup shows continual errors, beeps, or inconsistent wave output**

Step 1  
Make sure the QC5000 is closed.

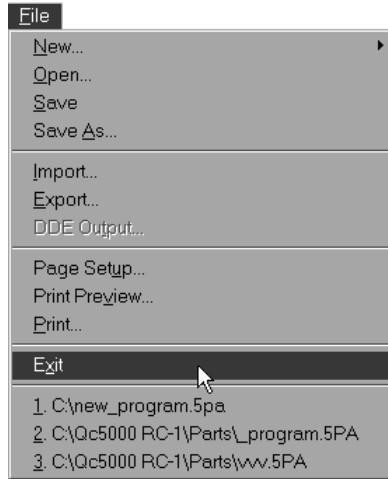

Step 2  
Close the encoder setup program.

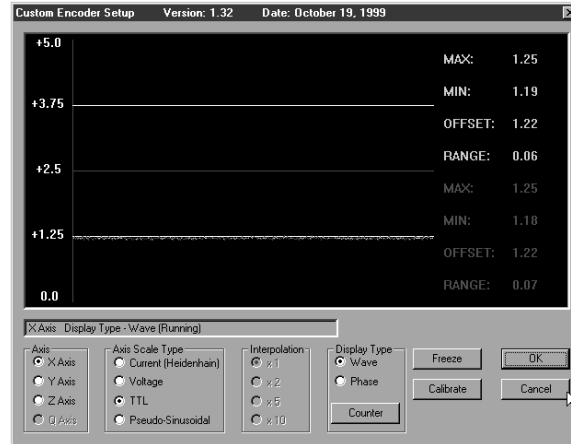

Step 3  
Re-open the encoder setup program.



**NOTE**

Check the Windows NT taskbar to be certain no other copies of QC5000 or Encoder Setup are running.

**Encoder setup show one or two errors after calibrating an axis**

Move the axis in a smooth, continuous, back-and-forth motion while calibrating. Uneven, stop/start motion can result in errors.

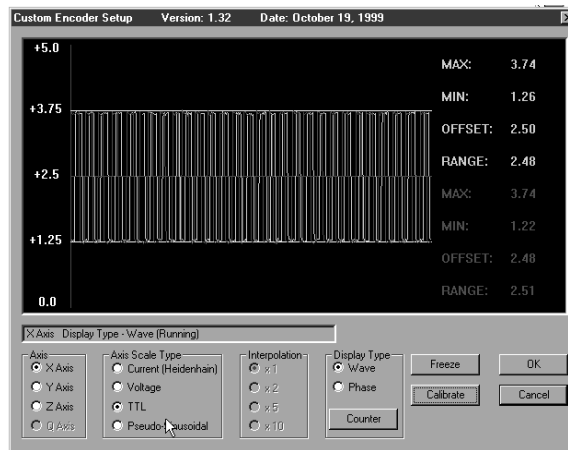

**NOTE**

One or two errors that do not count continually should not affect your measurements. Follow the procedure below for four or more errors.

### Encoder setup shows numerous errors after calibrating an axis

#### NOTE

Check the Windows NT taskbar to be certain no other copies of QC5000 or Encoder Setup are running.

#### Step 1

Re-calibrate the axis using a smooth, continuous, back-and-forth motion.

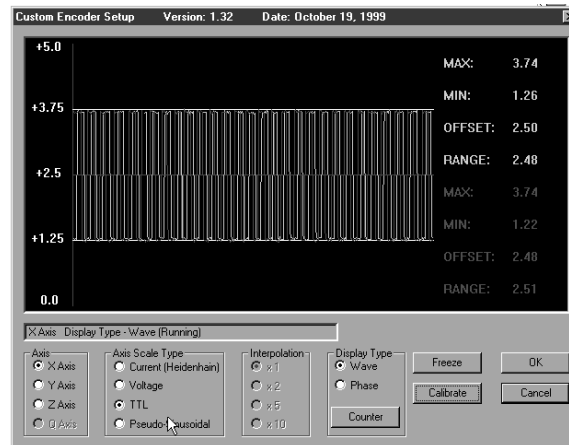

#### NOTE

If re-calibrating the axis does not solve the problem continue to step 2.

#### Step 2

Check all other axes for calibration problems.

#### NOTE

Discontinue troubleshooting and contact your distributor/OEM if no axis will calibrate properly.

Step 3  
Turn off the QC5000 computer.



**!** CAUTION

Do not disconnect QC5000 cables while the computer is on. This can result in damage to the system.

Step 4  
Disconnect the axis cables for the axes calibrating properly.

**METRONICS®** QC5000 Rear Connections

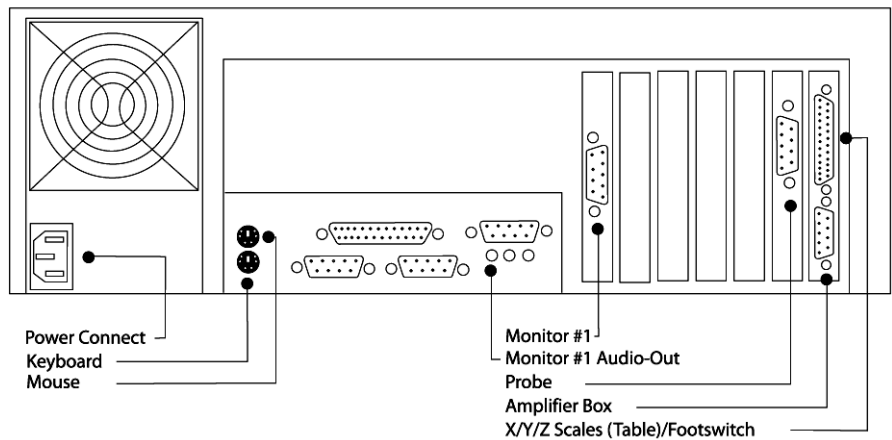

### Step 5

Disconnect the malfunctioning axis cable and connect it to one of the properly calibrating axis ports. For example, if the X axis calibrates properly and the Y does not, connect the Y axis to the X axis port.

### Step 6

Turn on the computer and open encoder setup.



### Step 7

Calibrate the desired axis. For example, if you have moved the Y axis cable to the X axis, calibrate the X axis.

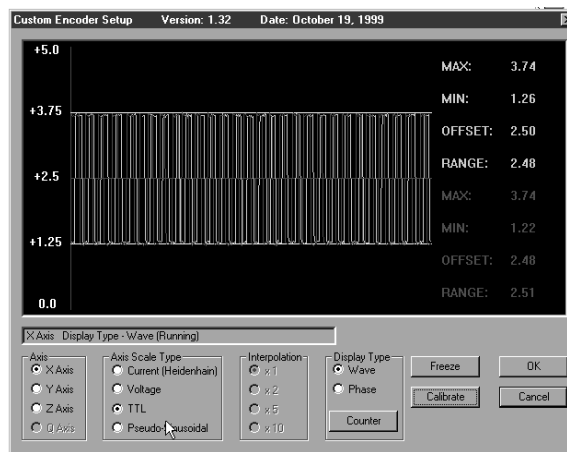

### NOTE

Discontinue troubleshooting and contact your distributor/OEM if the axis will not calibrate properly. There is an error on the CMM/encoder side of the system that may require repair.

### NOTE

Discontinue troubleshooting and contact your distributor/OEM if the axis calibrates properly. There is an error on QC5000 axis port that may require repair.

**Wave (amplitude) calibrates, phase does not calibrate**



If the phase display appears not to calibrate but the axis is not showing errors the system is functioning.



Check the Windows NT taskbar to be certain no other copies of QC5000 or Encoder Setup are running.

Step 1

Re-calibrate the axis using a smooth, continuous, back-and-forth motion.

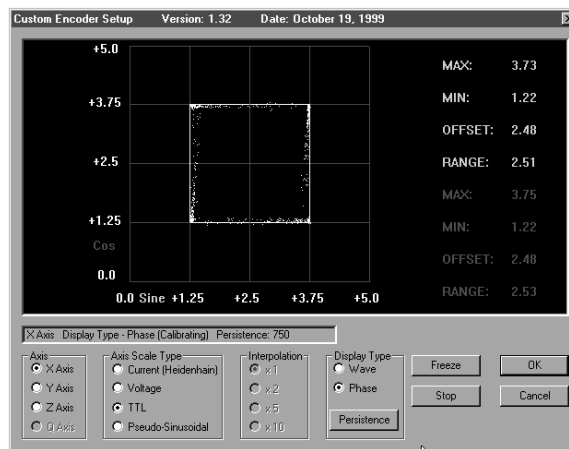

TTL encoders will not calibrate



TTL encoders do not require encoder setup. Use the following procedure.

Step 1  
Close encoder setup.

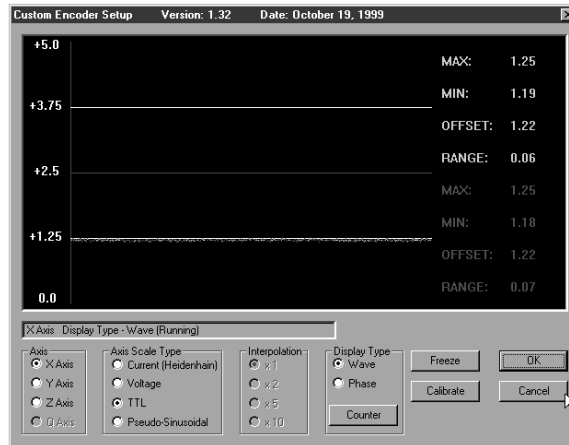

Step 2  
Open QC5000.



Step 3  
Select *options* then *general options* from the tool menu.





Step 4  
Select the *encoders* tab.

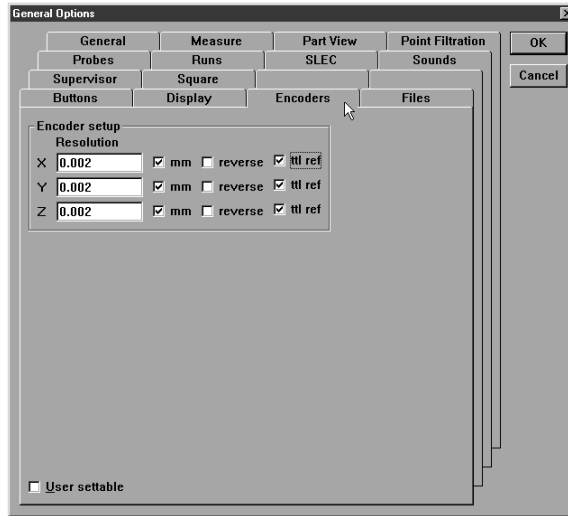

Step 5  
Select *TTL* as shown.

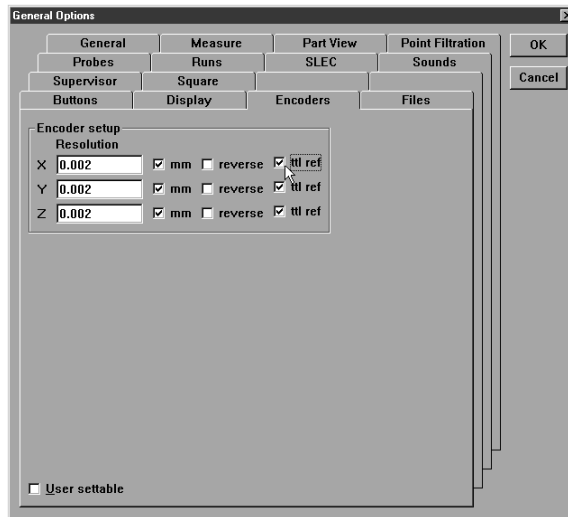

Status bar freezes during calibration or other error message

Step 1  
Close encoder setup.

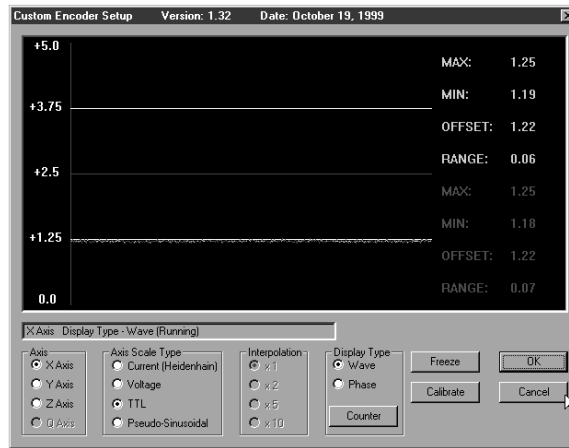

**NOTE**

Check the Windows NT taskbar to be certain no other copies of QC5000 or Encoder Setup are running.

Step 2  
Open encoder setup.



Step 3  
Calibrate the desired axis.

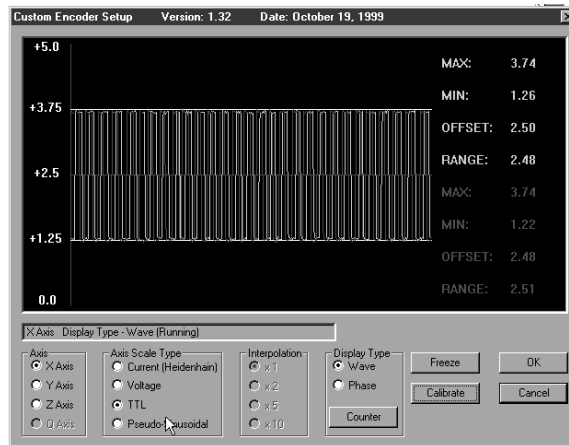



**NOTE**

**Discontinue troubleshooting and contact your distributor/OEM if the problem persists.**

Encoder setup icon is missing

Step 1  
Click the Windows NT *start button*.



Step 2  
Select *find*.

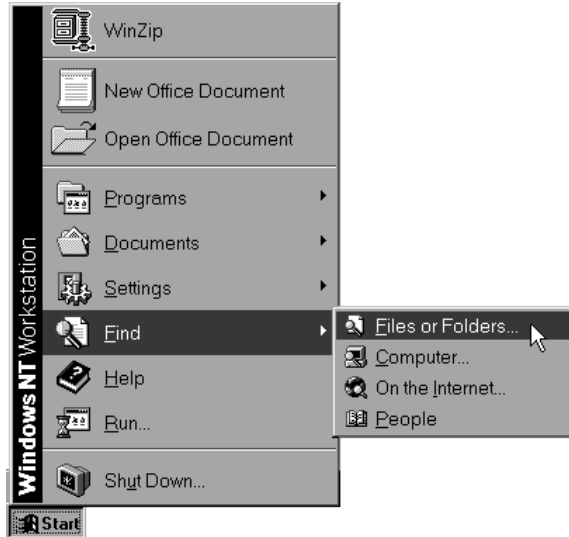

Step 3  
Type in the name *encsetup.exe* and click the *find now* button.

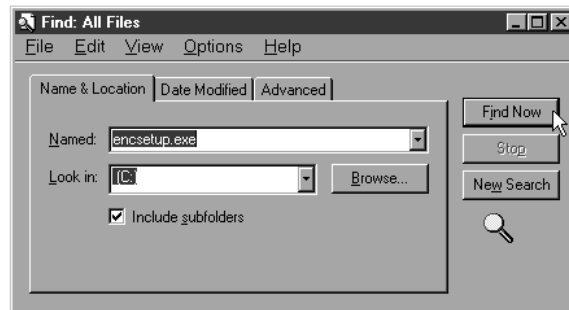

Step 4  
Highlight the *encsetup.exe* file.

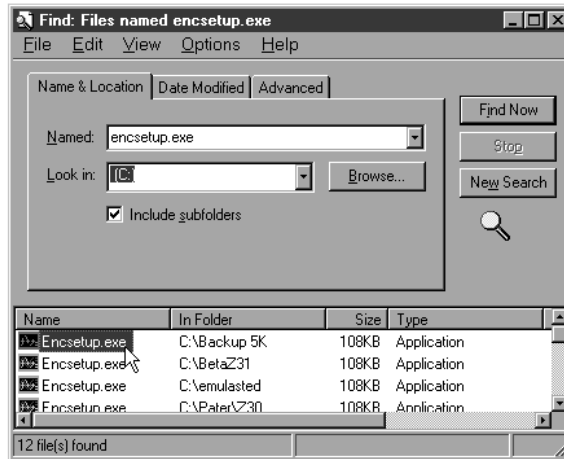

Step 5  
Right click and select *create shortcut*.

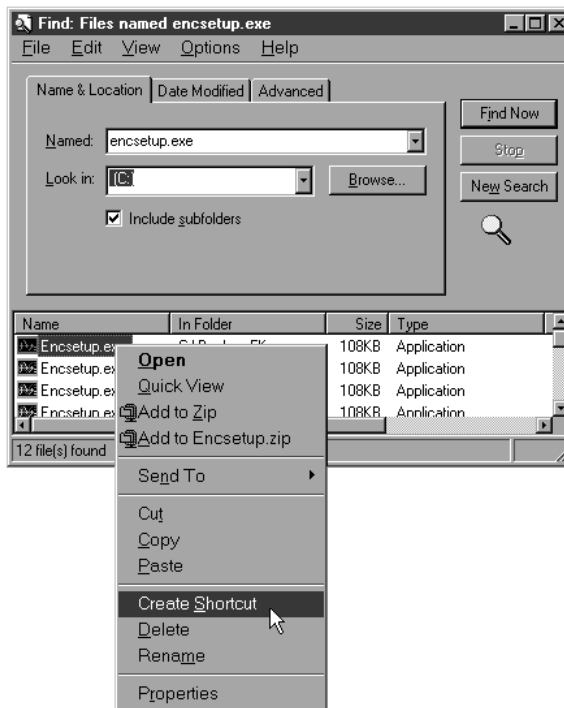

Step 6  
Click *yes* in the dialog box.

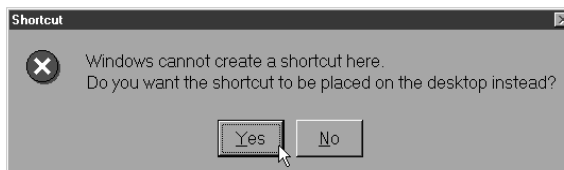

QC5000 counts double, half, or wrong



This process requires the EXACT resolution of the scales. Contact the manufacturer for this information if it is unavailable.

Step 1  
Select *options* from the tools menu.



Step 2  
Select the *encoders* tab.

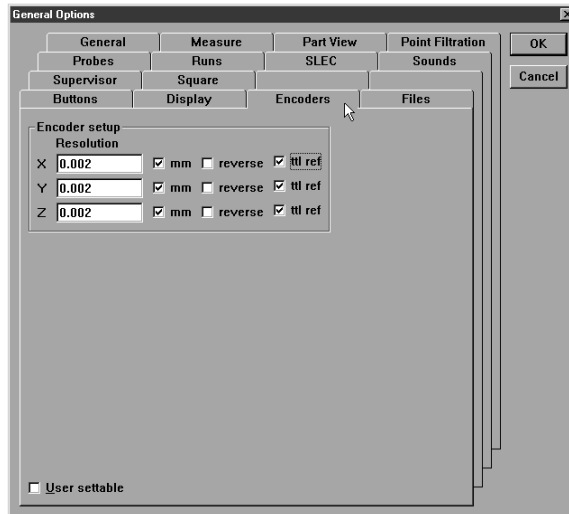

Step 3

Check the *mm check box* if the encoder resolution is metric. Remove the check if encoder resolution is english.

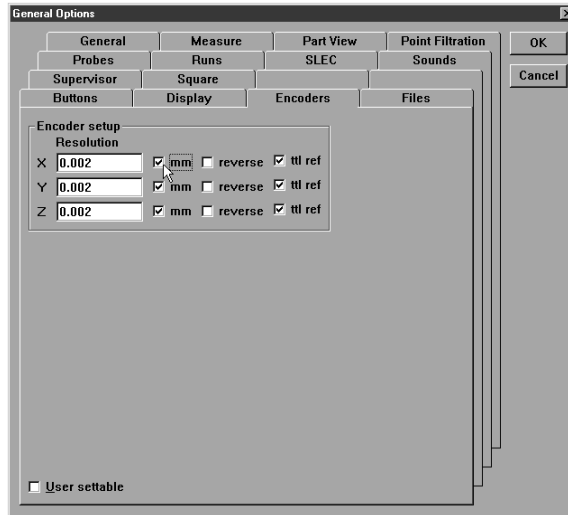

Step 4

Enter the proper resolution for each axis as shown.

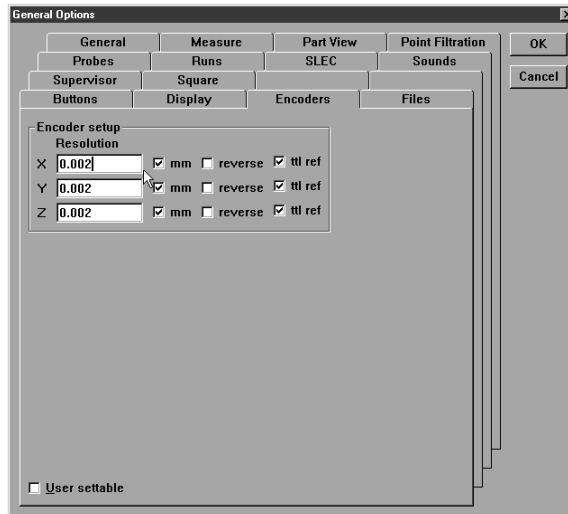

Step 5  
Select the proper encoder type.

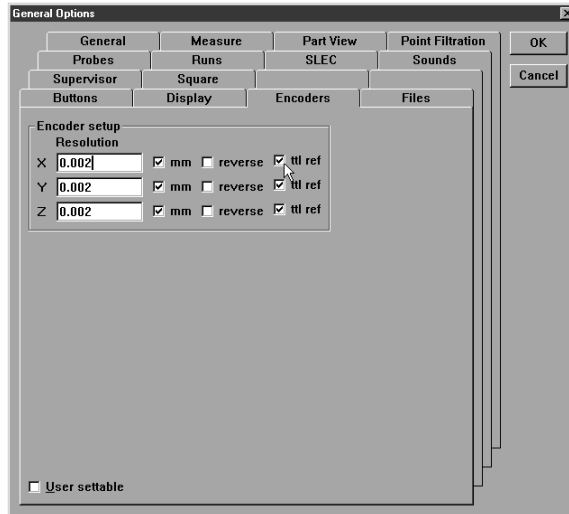

Step 6  
Select the display tab.

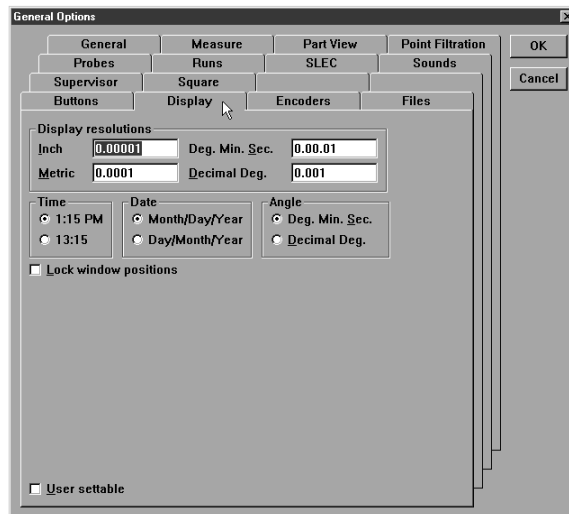



Step 7

Set display resolutions the same as the encoder resolutions.

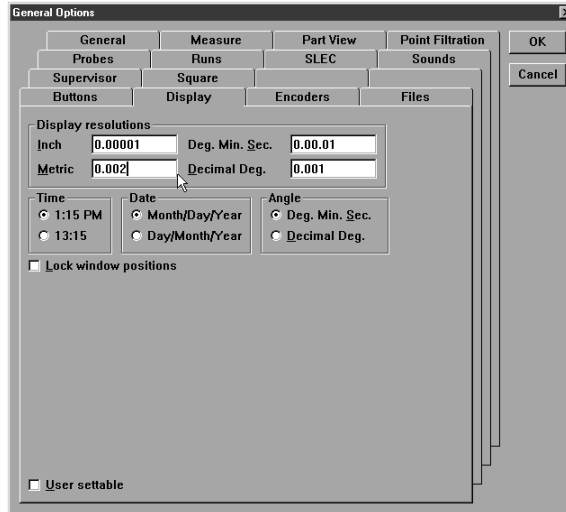

Step 8

Click OK.

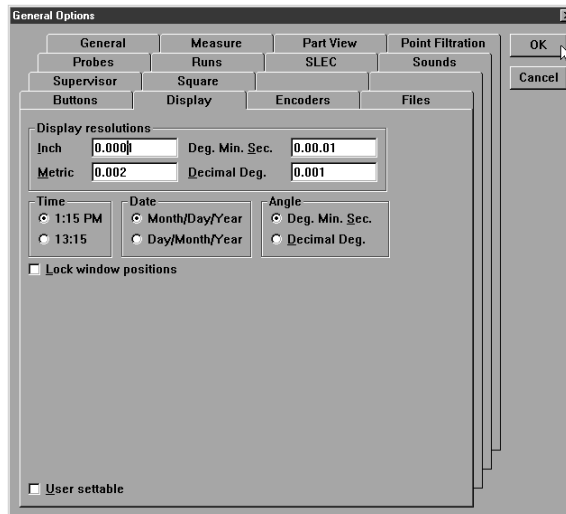

**NOTE**

Measure a gage block to check the new settings. If the result is half the standard, repeat this procedure and double the resolution settings.

## Chapter 8 Setup

### Supervisor Password

System level functions in the QC5000 are password protected. The supervisor password must be entered before changes can be made in these areas.



#### NOTE

Contact your Metronics distributor or OEM for lost or misplaced passwords.

#### To enter the supervisor password

##### Step 1

Select *options* then *general options* from the tools menu.

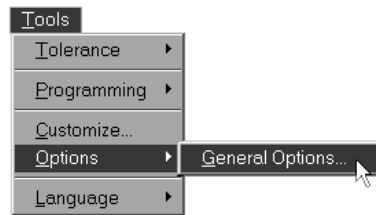

##### Step 2

Select the *supervisor* tab.

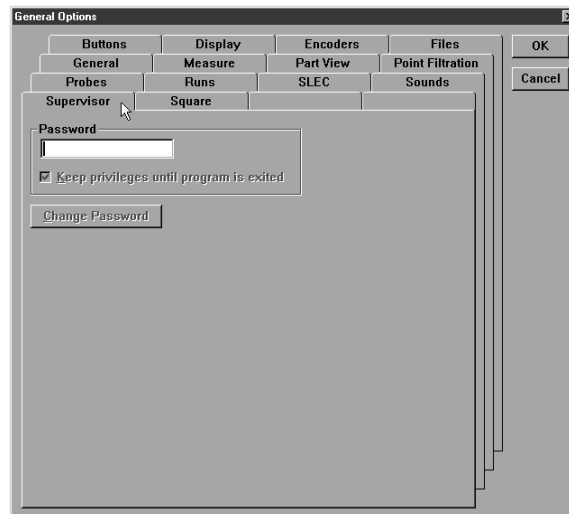

Step 3  
Enter the password as shown.

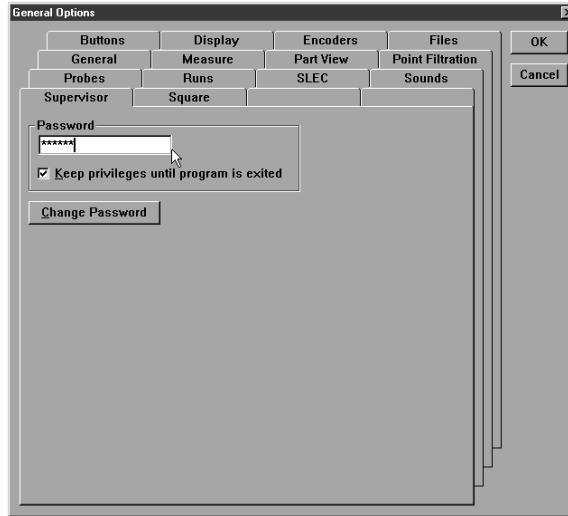

Step 4  
Click OK in the dialog box.

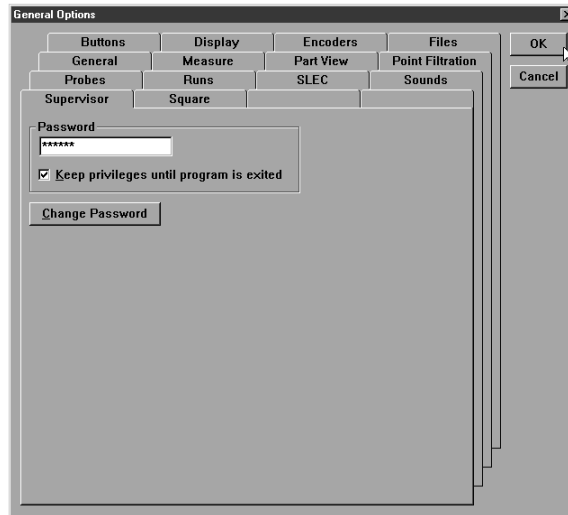

 **NOTE**

Click the verify button and place a check in the *keep privileges until program is exited* box to continue supervisor access until exiting the QC5000.

Supervisors may restrict access to any portion of the options window.

### To restrict access to general options tabs



This demonstration uses the *display* tab but the steps may be used to restrict access to any tab in the options window.

Step 1

Click on the desired tab.

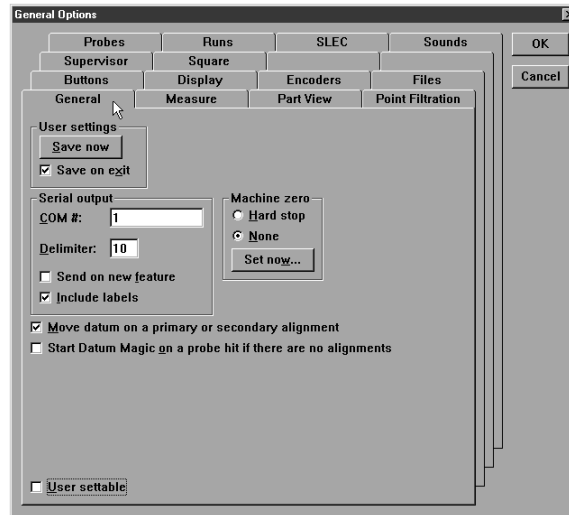

Step 2

Remove the check from the *user settable* box.



If there is no check in the box the tab is already restricted.

Step 3  
Click OK.

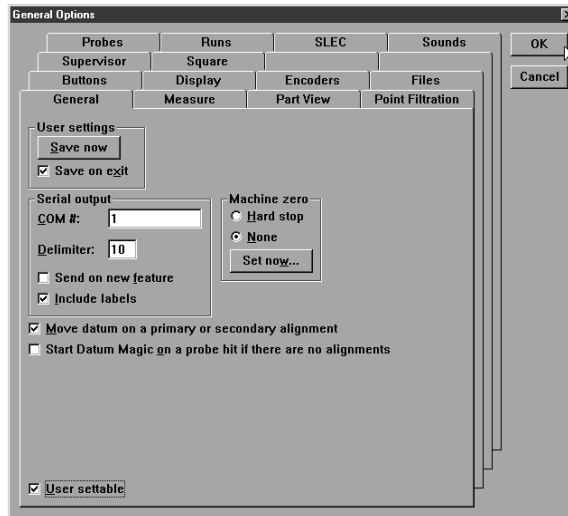

## Chapter 8 Setup

### General Options

Use the general options window to manage and change QC5000 settings. Tabs in the general options windows are:

- Buttons
- Display
- Encoders
- General
- Measure
- Part view
- Probes
- SLEC
- Sounds
- Supervisor
- Square

#### Buttons

Use the buttons tab to set the function of external input buttons (footswitch, etc).

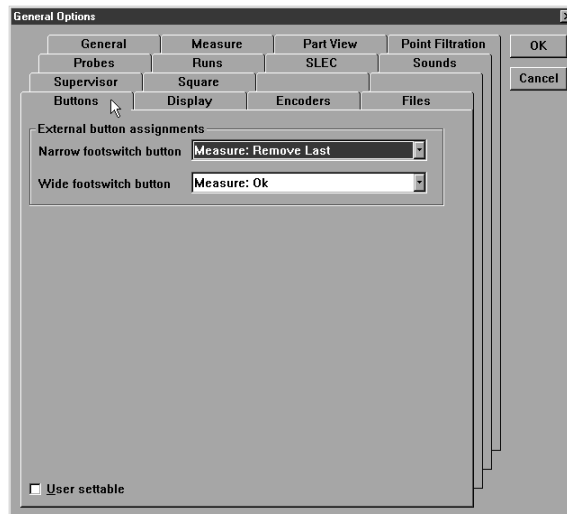

Select one of the following functions to be executed by external devices:

- Measure: OK
- Measure: Enter
- Measure: Remove Last
- Measure: Cancel
- View From Probe

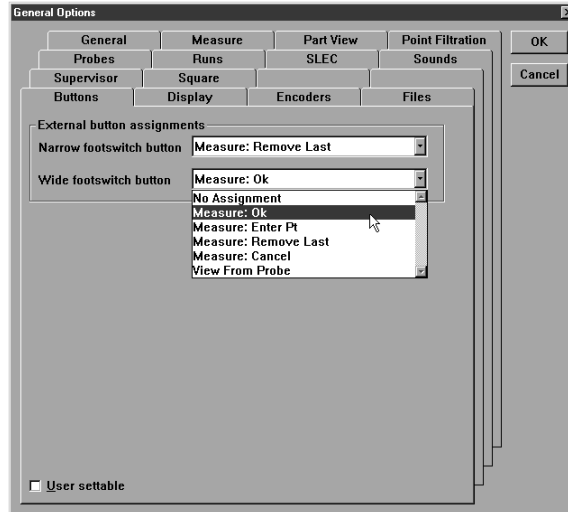

For example, set button 1 to Measure: OK. Each time button 1 is pressed during a measurement it is the same as clicking OK in the measure dialog box.

To set a button function

Step 1

Select the desired function from the pull down list.

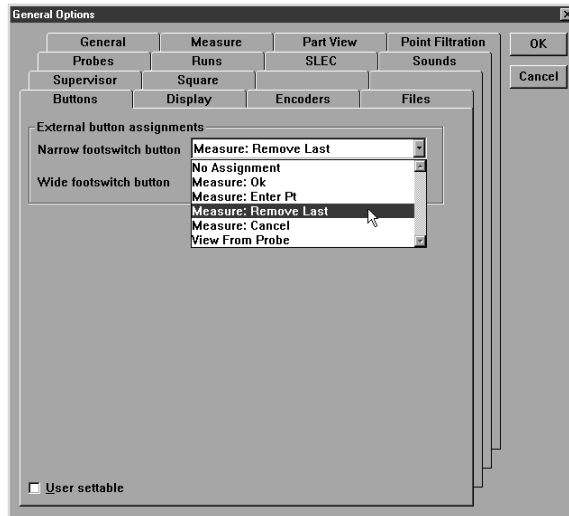

Step 2

Click OK.

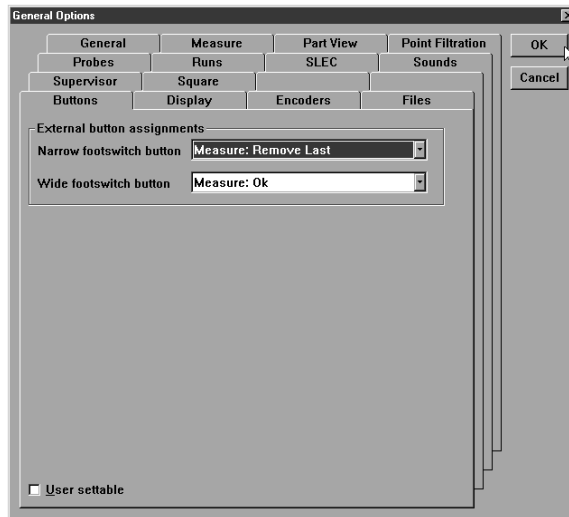



## Display

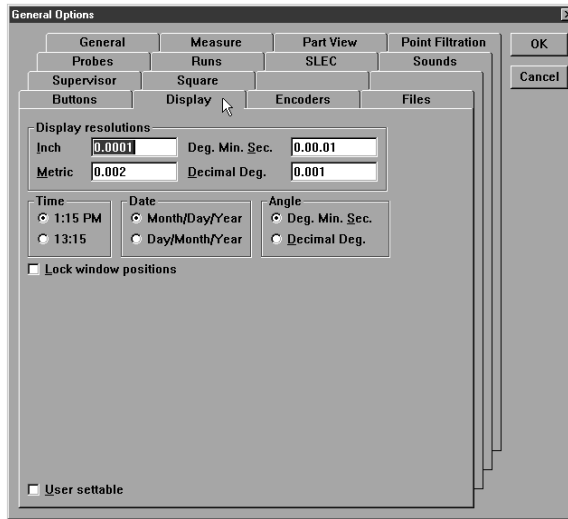

Use the display tab to manage display resolutions, time/date display, and angle units display.

Enter the resolution of the CMM's encoders in the display resolution boxes. Make sure to enter the values in the proper units. For example, do not enter a metric (unconverted) resolution in the inch display resolution box.

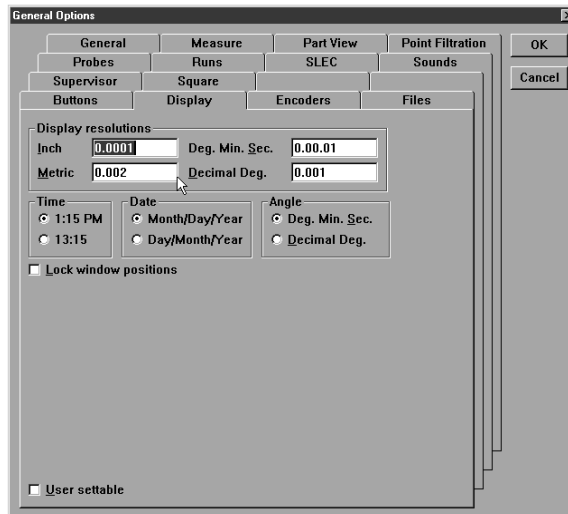

Select the time and date display from the radial button options.

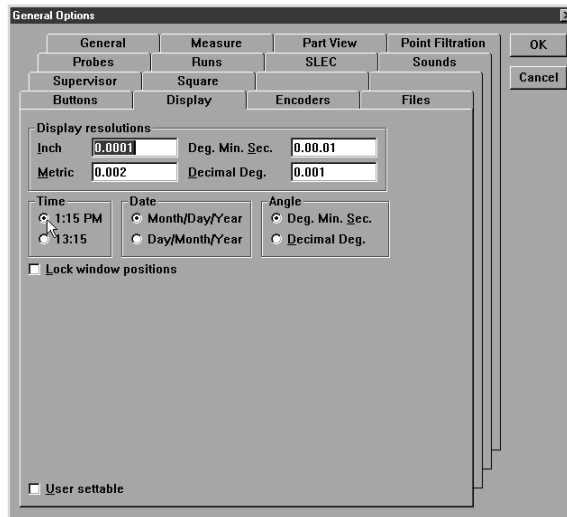

Select angle units to be displayed as degrees/minutes/seconds OR decimal degrees.

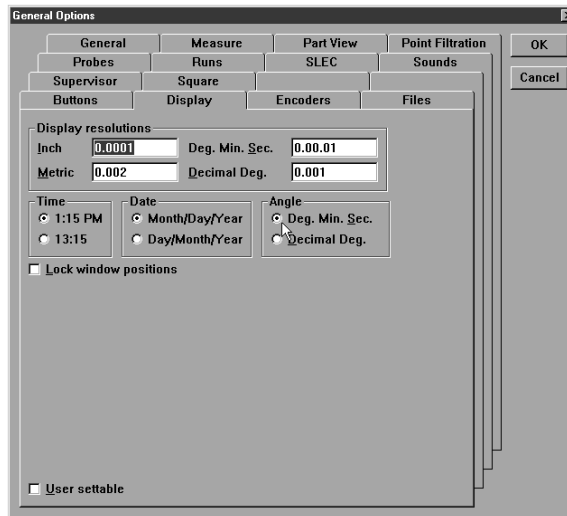

Check the *lock windows position* box to lock QC5000 windows in their current locations.

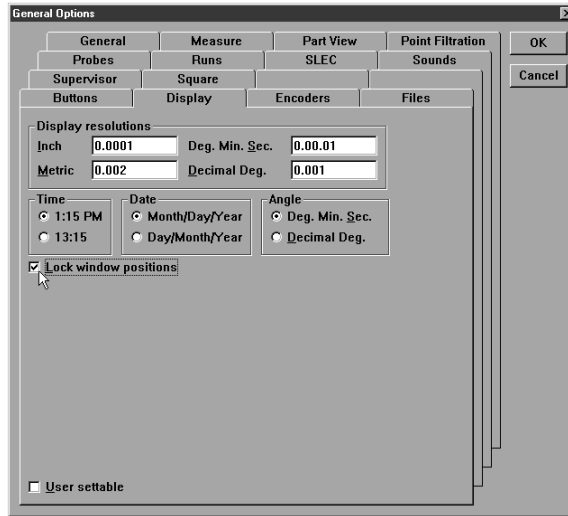

### Encoders

Use the encoders tab to enter the encoder resolution. Enter the resolution values carefully; incorrectly entered resolutions will result in inaccurate measurements.

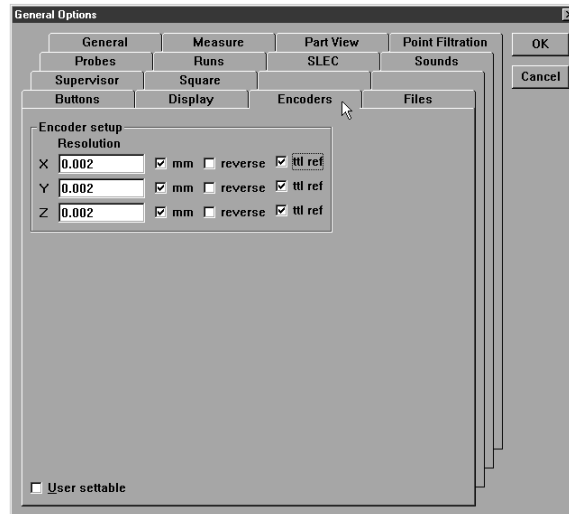

### NOTE

Enter the resolution in the proper units (mm or inches).

Check the *mm* box if encoder units are metric.

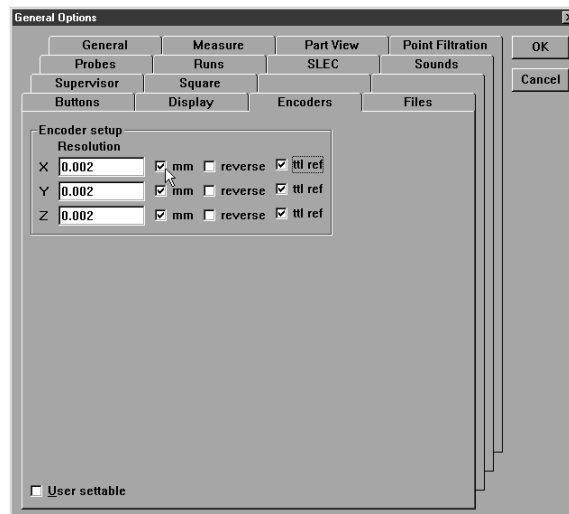

Check the *reverse* box to reverse the count direction of an axis.

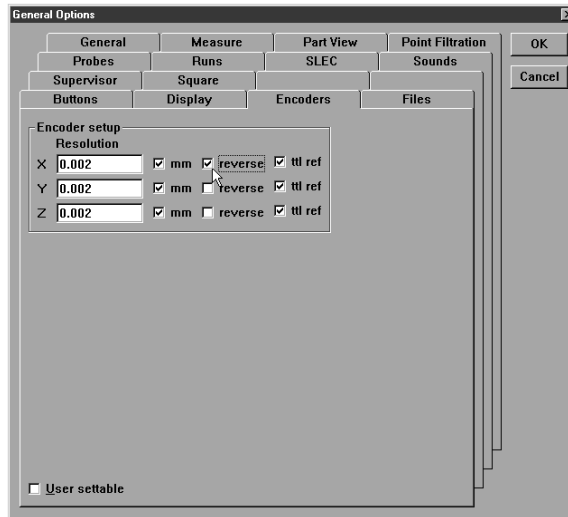

To enter encoder resolution

Step 1

Type the encoder resolution for the desired axis box as shown.

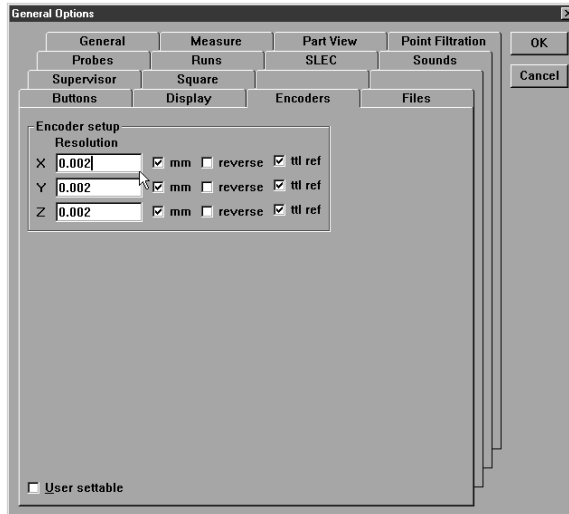

Step 2

Click OK.

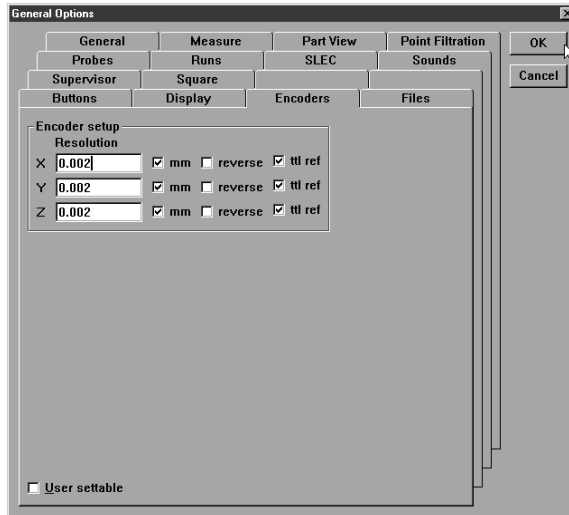

### General

Use the general tab to save option settings without exiting the options window and specify machine zero method.

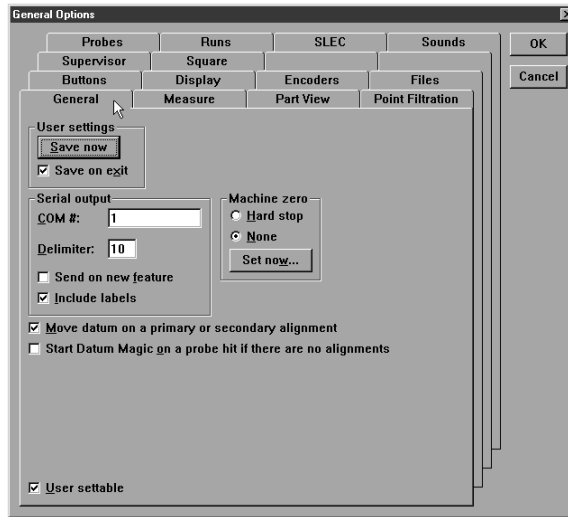

### To set machine zero

#### Step 1

Select *hard stop* in the machine zero box.

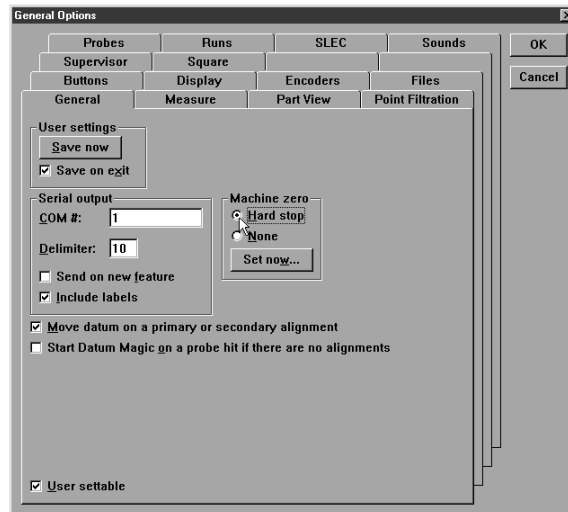

Step 2  
Click the *set now* button.

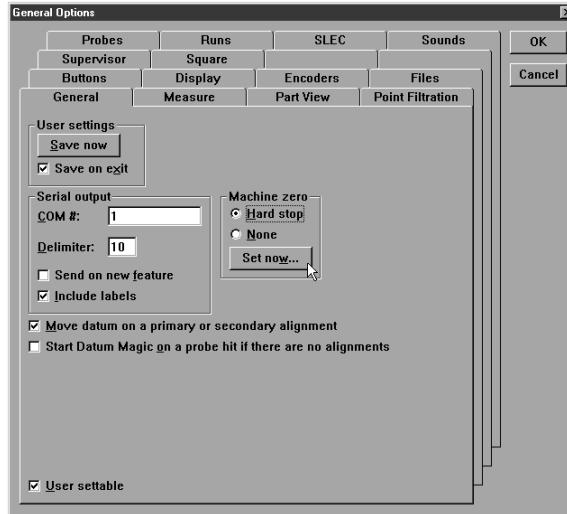

Step 3  
Move the axes of the CMM to the machine zero position.

Step 4  
Click OK in the dialog box.

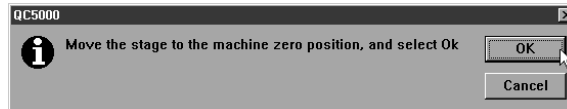

Step 5  
Click OK in the *general options* window.

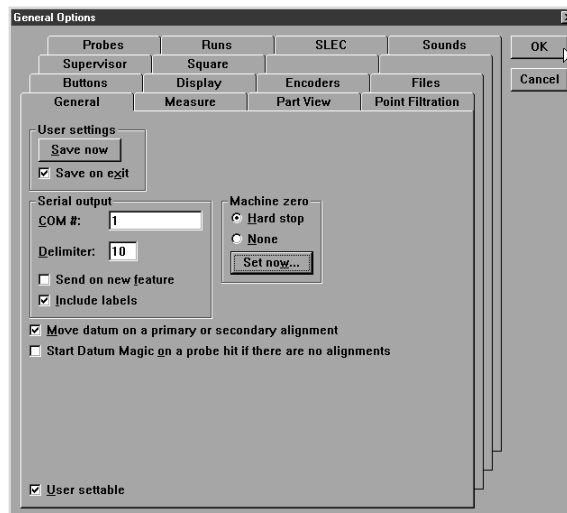



## Measure

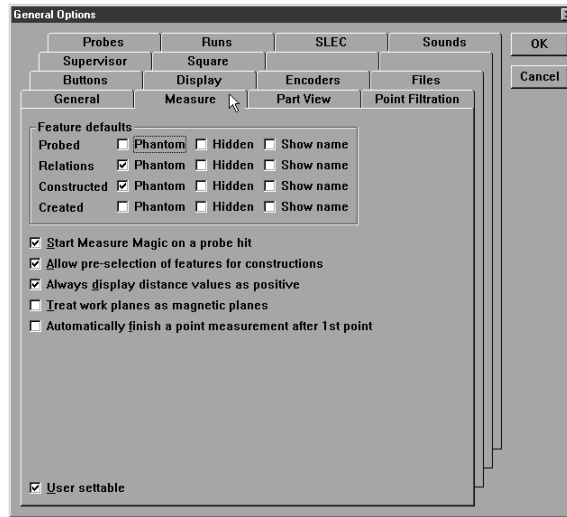

Use the measure tab to establish the default display characteristics in the part view window. Defaults established on this tab apply to all features in the selected category:

- probed
- relations
- constructed
- created



### NOTE

**Individual feature display characteristics (as opposed to groups of features) can be modified using feature properties.**

Select *phantom* to show features as dotted lines in the part view window.

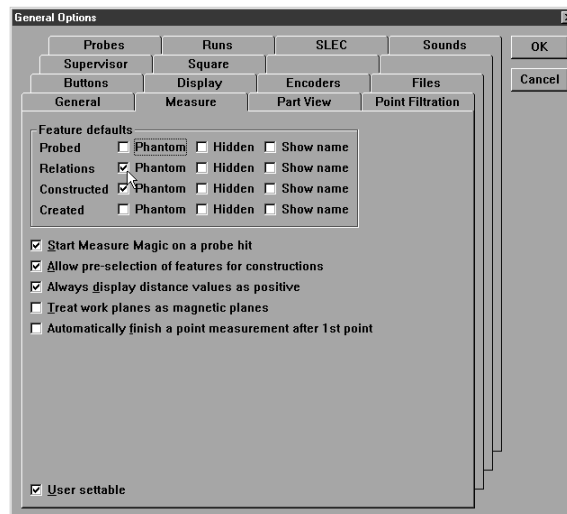

Check *hidden* to remove a feature from the part view window; hidden features still appear in the features list.

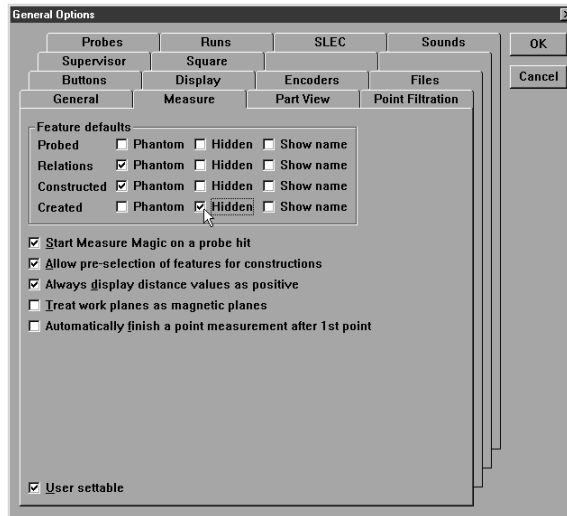

Display the feature name by placing a check in the *show name* box.

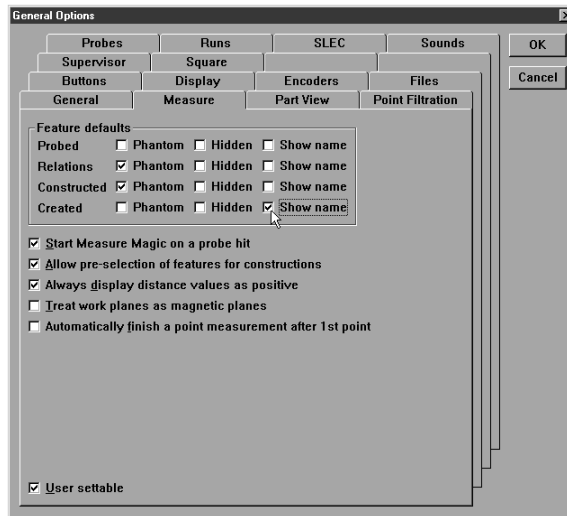

Check *start measure magic on a probe hit* to start measure magic at the first point probed.

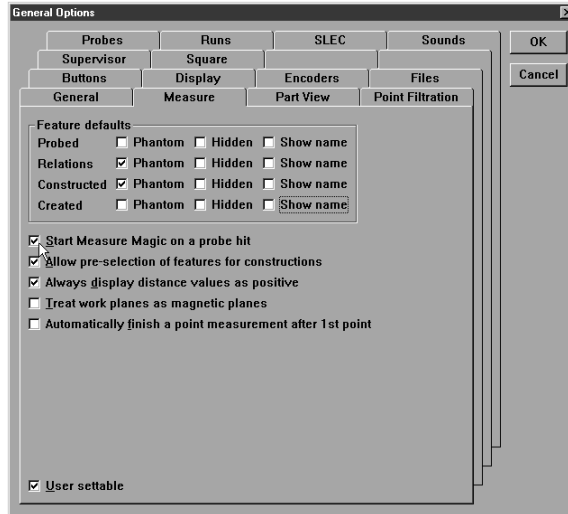

Check *allow pre-selection of features for construction* to permit users to select features for a construction then select the type of construction.

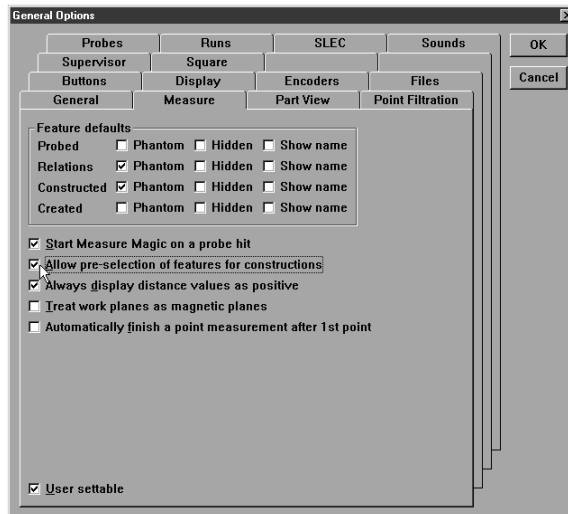

Check *always display distance values as positive* to show distance measurements in positive numbers regardless of the actual direction of measurement.

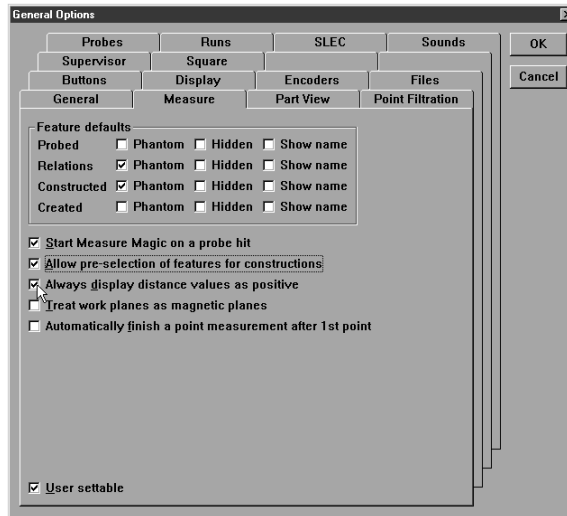

Check *treat work planes as magnetic* to snap two-dimensional figures to the current plane.

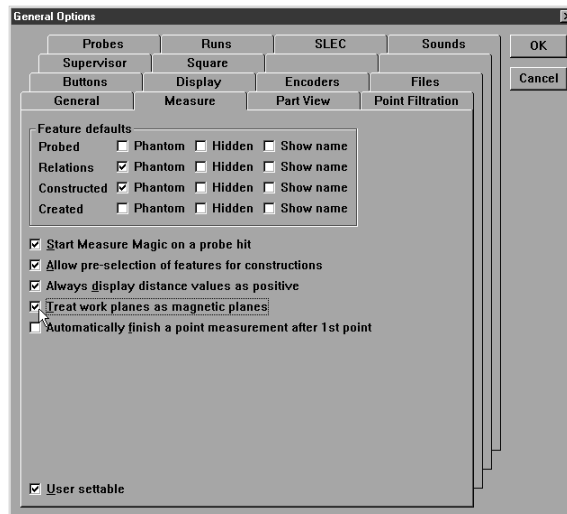

Check *automatically finish a point measurement after the 1st point* to limit point measurements to one probe hit.

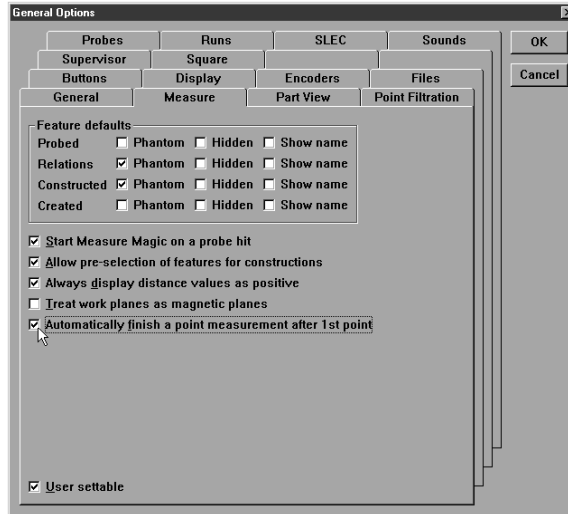

Part view

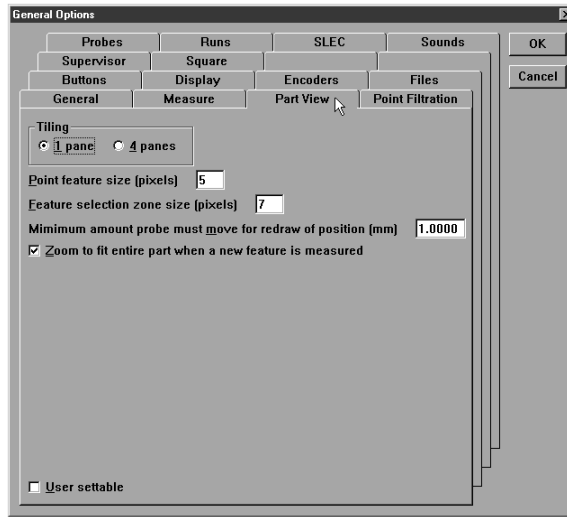

Use the part view tab to toggle the part view window between 1 pane and 4 pane mode, set the pixel size of points in the part view, and set the amount of probe movement required to redraw the part view (view from probe mode).

Click the radial button to select 1 pane or 4 pane part view.

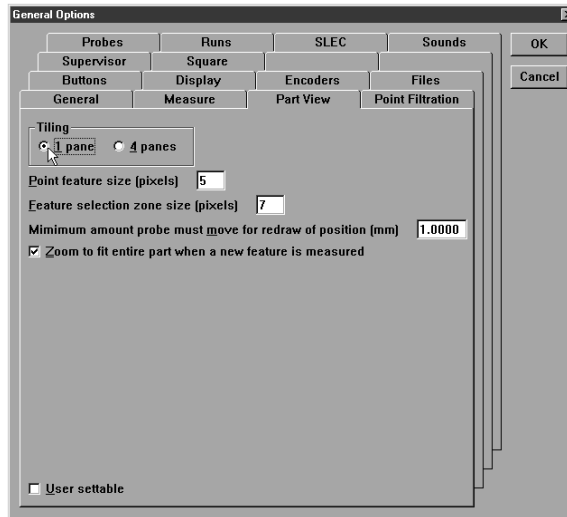

Enter a value for the size of a point (in pixels) in the part view window.

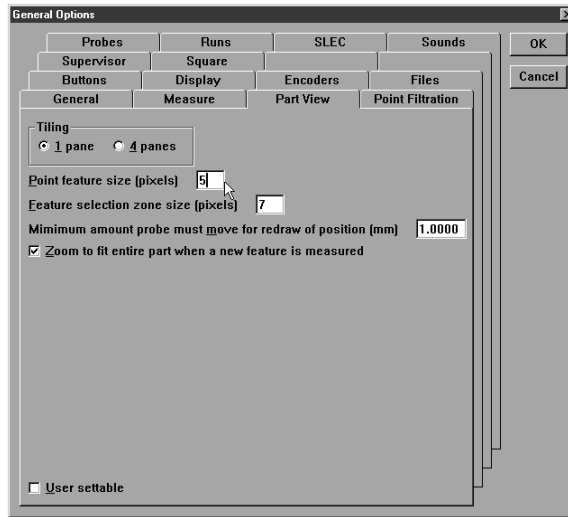

Enter the distance the probe must move for the part view to be re-drawn.

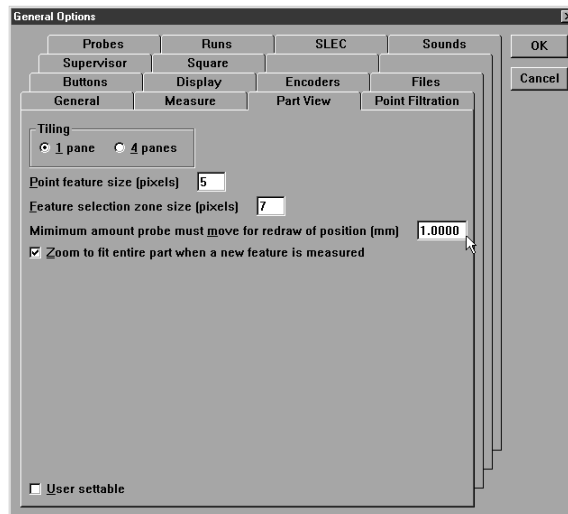

Probes

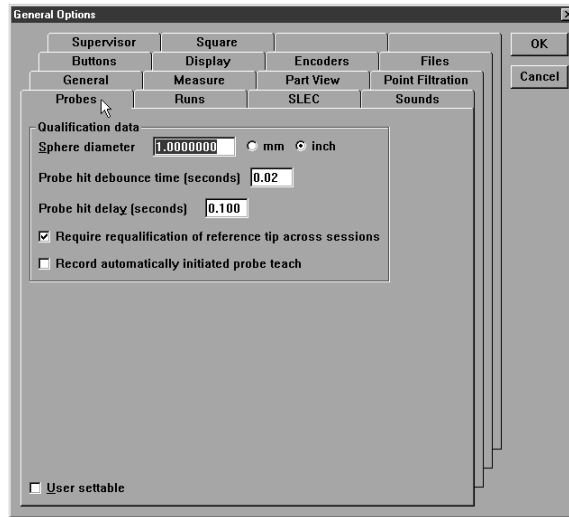

Use the probes tab to enter the diameter of qualification spheres, set probe hit de-bounce time, and set probe direction threshold.



**To enter the diameter of a qualification sphere**

Step 1

Type the resolution in as shown.

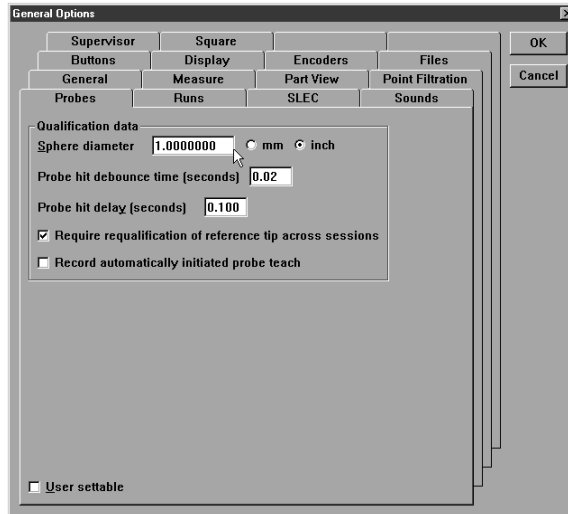

Step 2

Check the *mm* box if units are metric, otherwise leave unchecked.

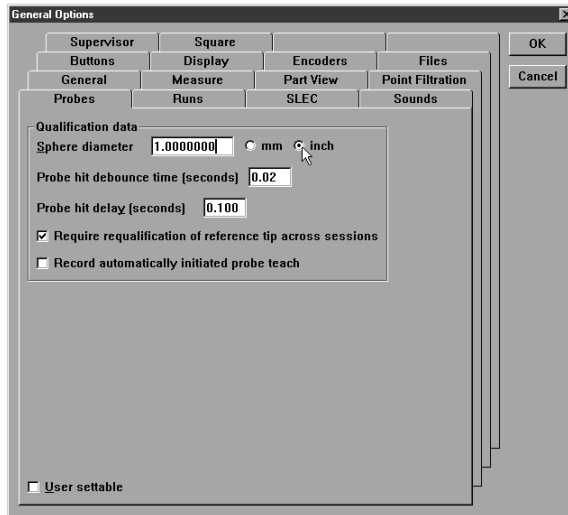

Step 3  
Click OK

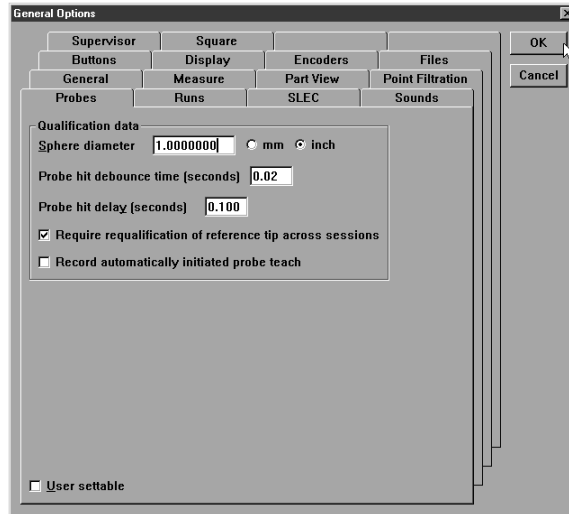

Check *require re-qualification of reference tip across sessions* to prompt the user to teach the reference tip at startup.

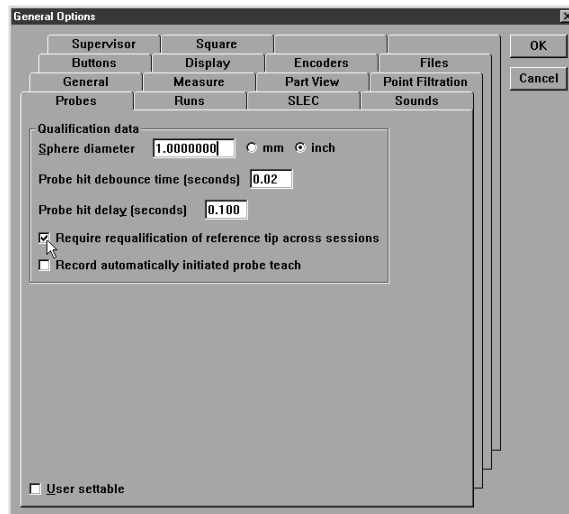

Check *record automatically initiated probe teach* to record a teach program when an unqualified probe tip is selected.

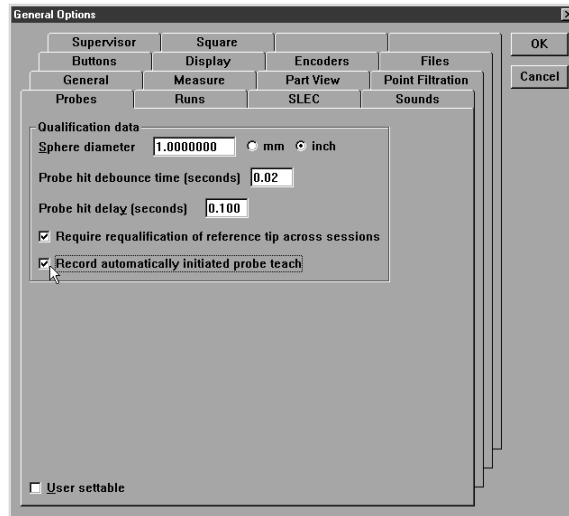

Point Filtration

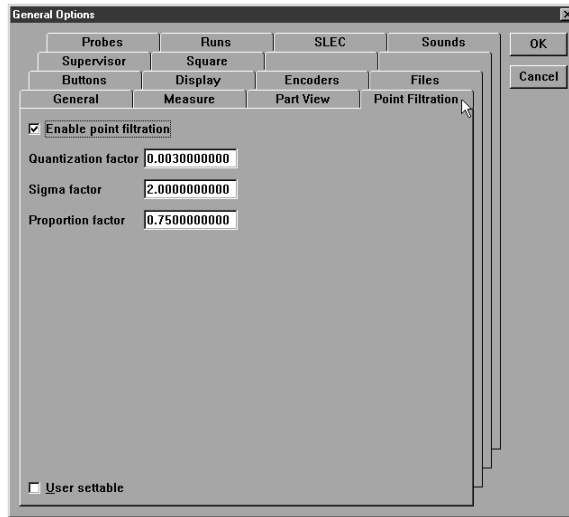

Use the point filtration tab to remove outlier points from measurements. Enter the following values on this tab:

- quantization factor (absolute threshold for outlier points)

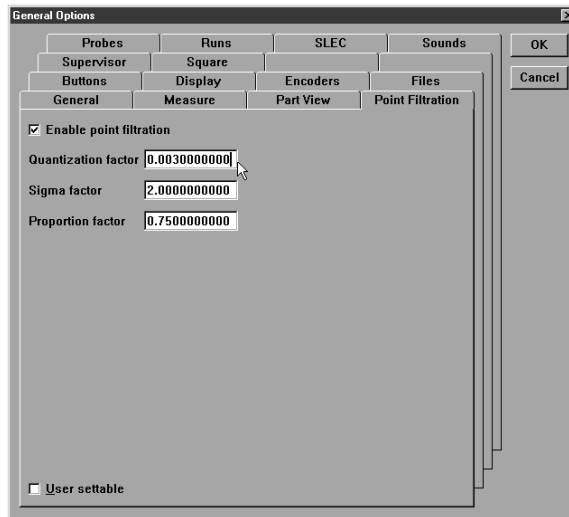

- sigma factor (number of standard deviations points must lie within)

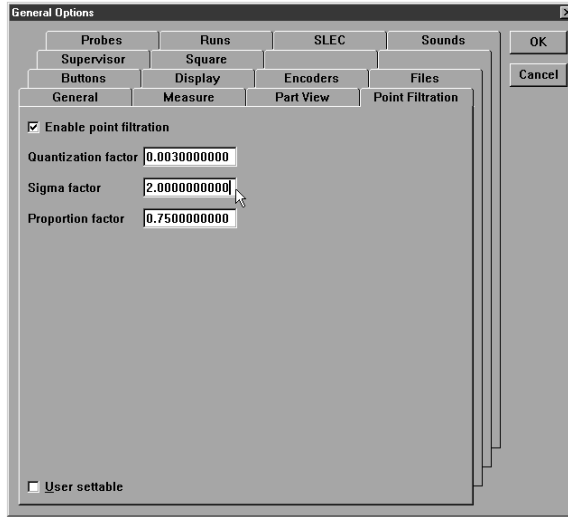

- proportion factor (percentage of original points that must be retained)

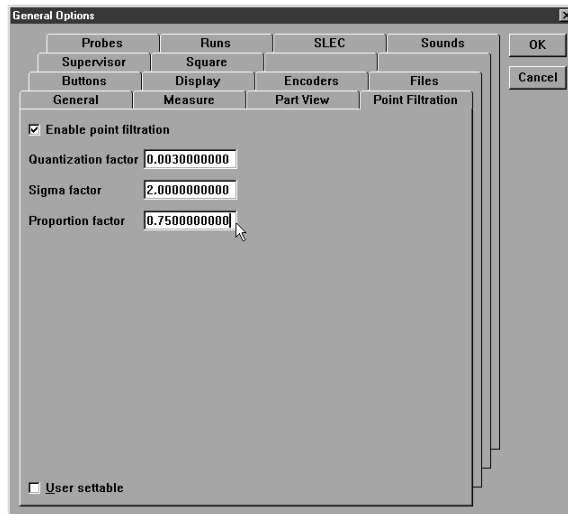

### Files

Use the files tab to manage QC5000 system specific files. Determine default directories for system files on this tab.

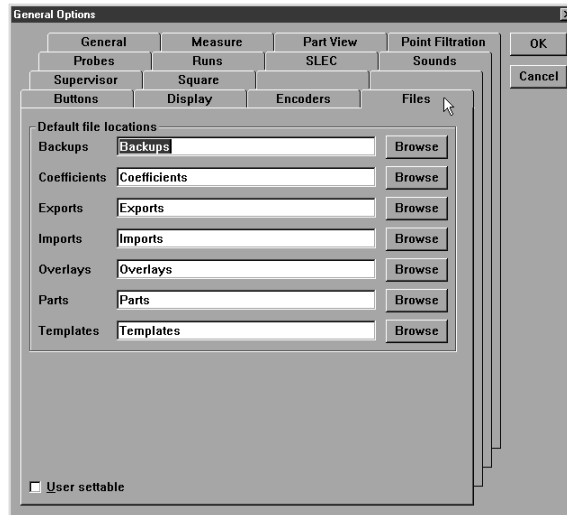

**SLEC (segmented linear error correction)**

Use the SLEC tab to setup and enter SLEC data. SLEC applies linear error correction coefficients to segments of each axis to compensate for encoder and machine travel variations. Use a standard to measure each axis and compare the measured (observed) values to the nominal (standard) values to generate correction coefficients. Correction coefficients are generated for each segment that deviates from the standard value and provide linear compensation for that segment.

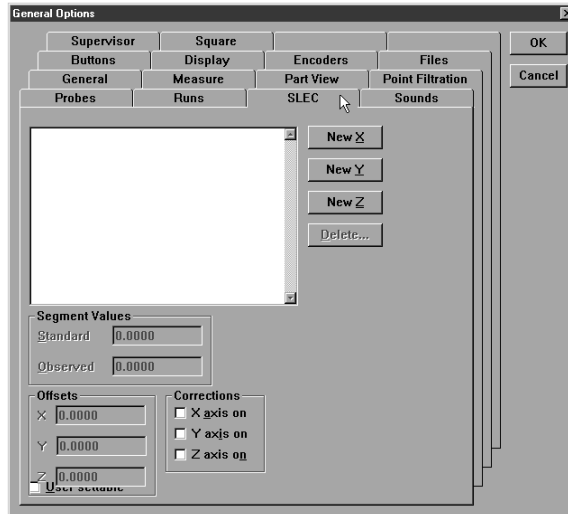

Enter the zero point first for each axis. This does not mean that each axis must start a zero: negative values can be entered. For example, you can enter the zero point for the X axis and then enter standard and observed values for -2.

Correction for the final point on each axes continues in constant manner. Thus a correction applied to the final point continues for all points past the final point. Likewise, if no correction is applied to the final point, no correction applies to points beyond it.

**NOTE**

**Do not use SLEC if your CMM does NOT have a repeatable machine zero. SLEC requires a repeatable machine zero point.**

To enter SLEC data

Step 1

Move the CMM to machine zero.

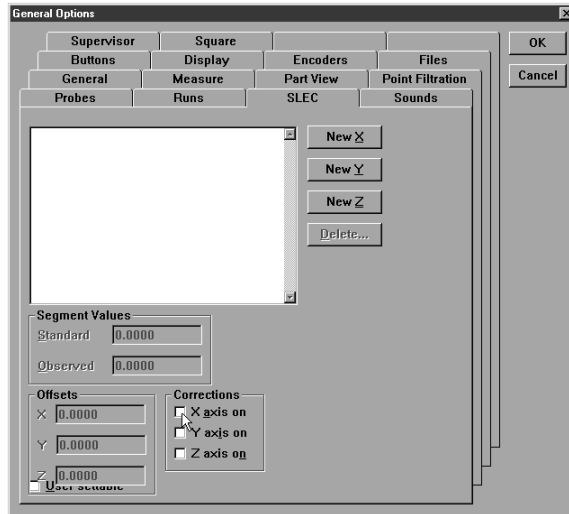

Step 2

Disable (uncheck) *corrections* on the X, Y, and Z axes on the SLEC tab.

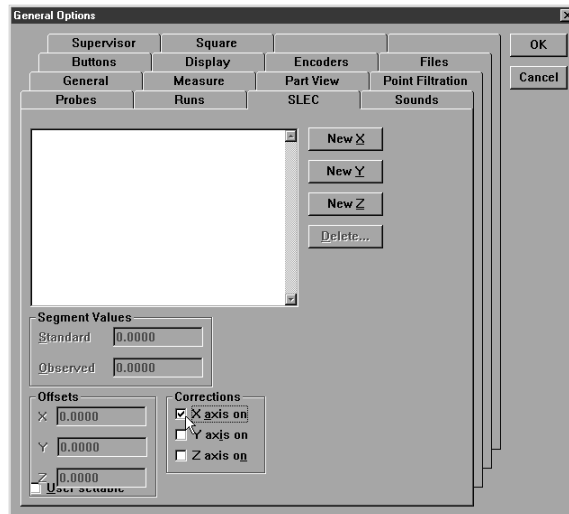



Step 3  
Click *new X*.

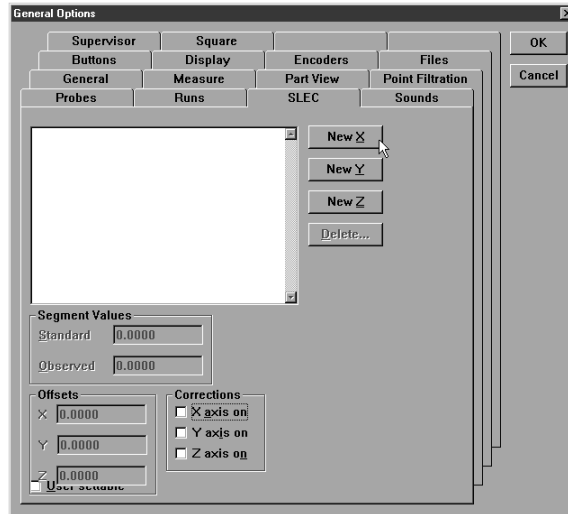

Step 4  
Click *new Y*.

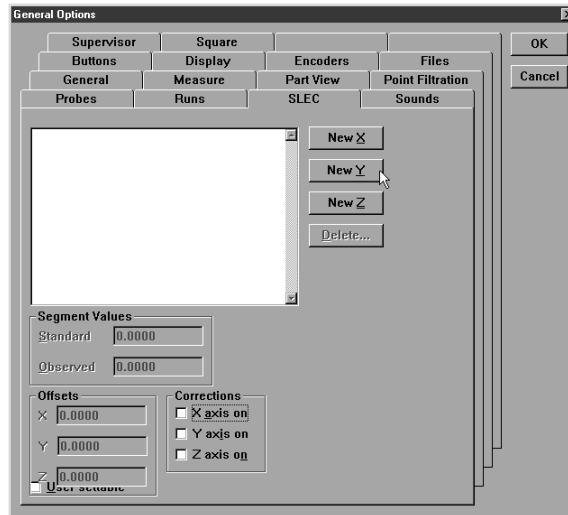

Step 5  
Click *new Z*.

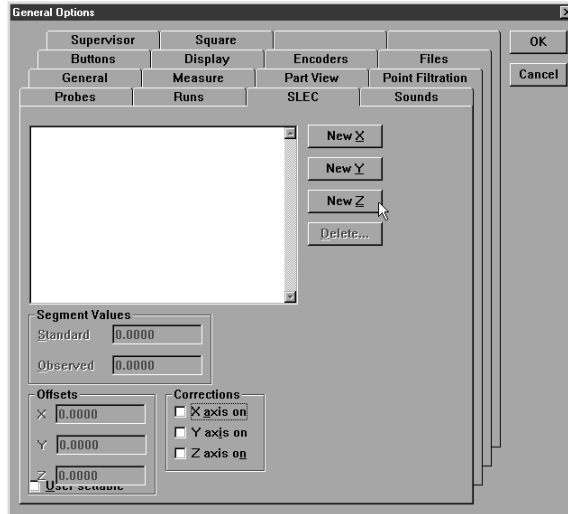

Step 6  
Enter the standard and observed value for the first point on the X axis as shown.

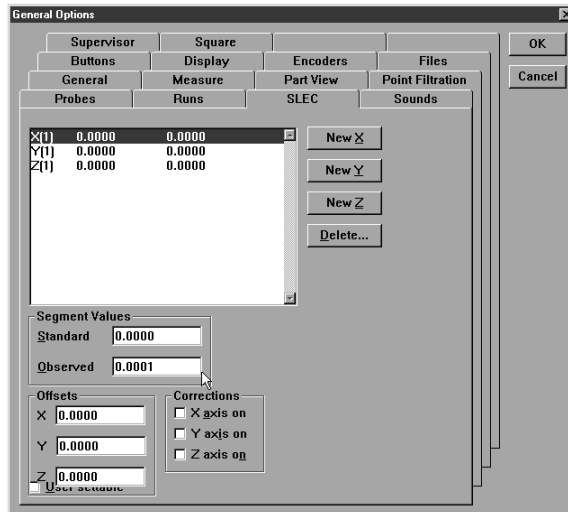

Step 7  
Click *new X*.

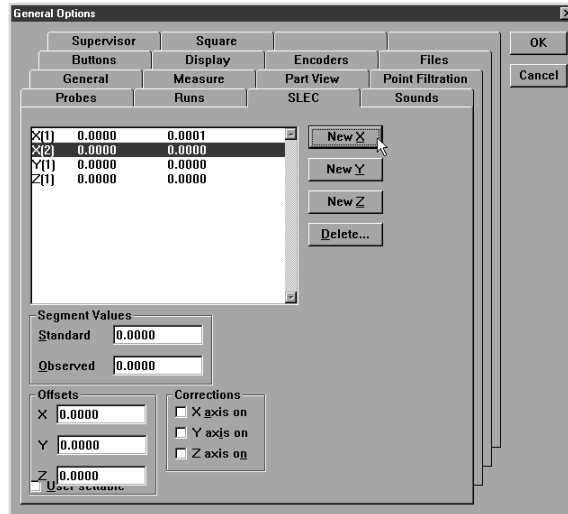

**Repeat steps 6 and 7 until all points are entered.**

Step 8  
Enter the standard and observed value for the first point on the Y axis as shown.

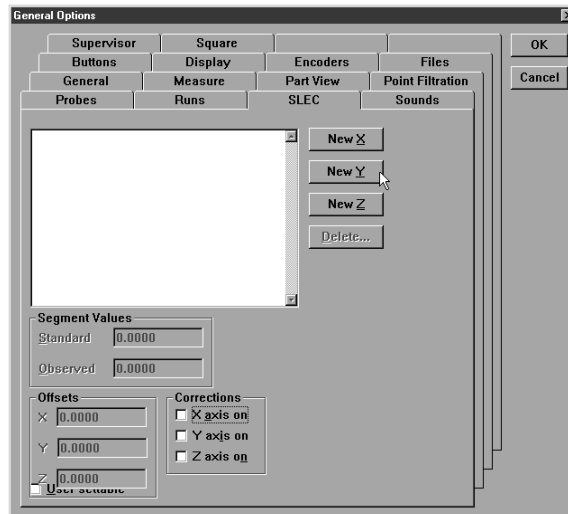

Step 9  
Click *new Y*.

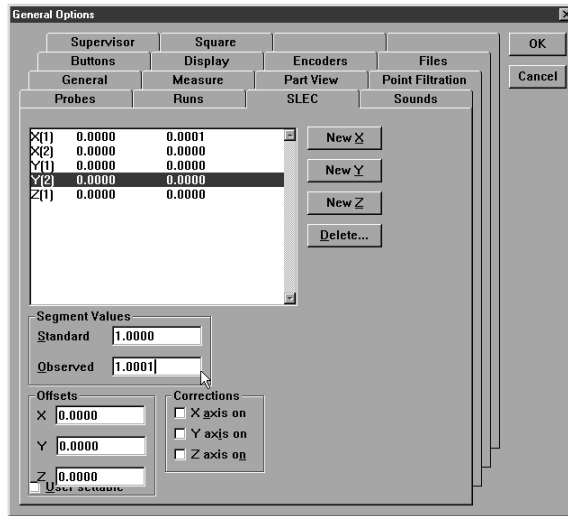

**NOTE**  
Repeat steps 8 and 9 until all points are entered.

Step 10  
Enter the standard and observed value for the first point on the Z axis as shown.

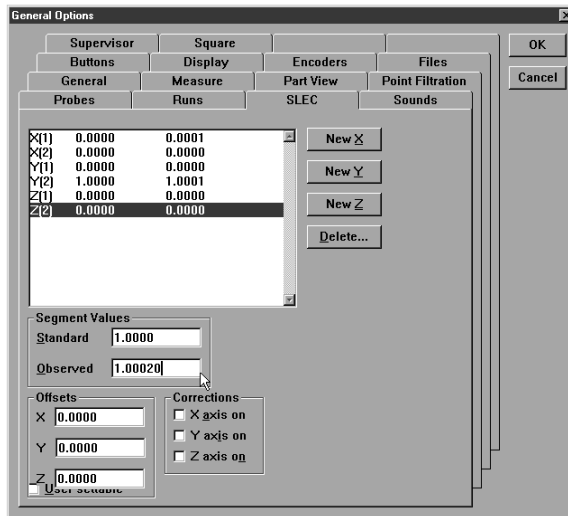

Step 11  
Click *new Z*.

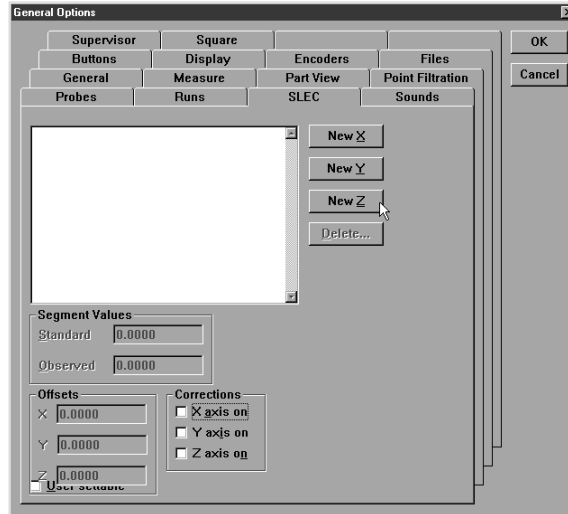

**NOTE**

Repeat steps 10 and 11 until all points are entered.

Step 12  
Enable corrections on the X, Y, and Z axes as shown.

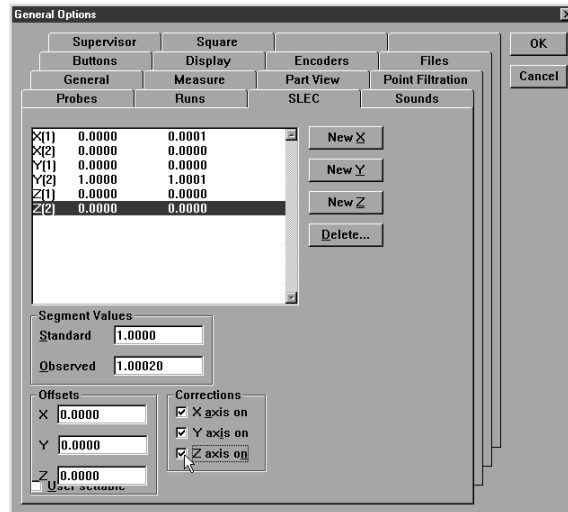

Step 13  
Click OK.

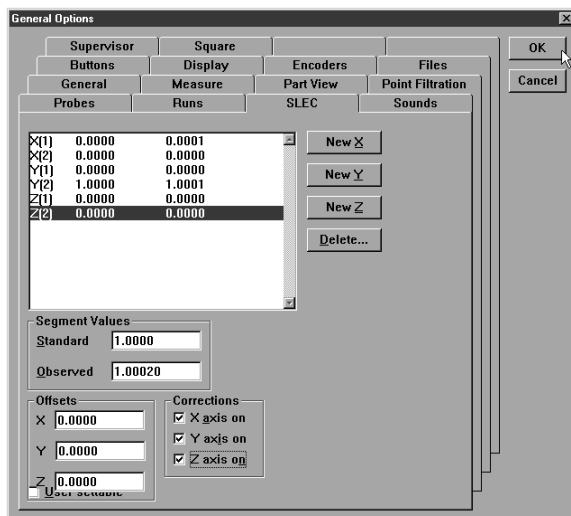

## Sounds

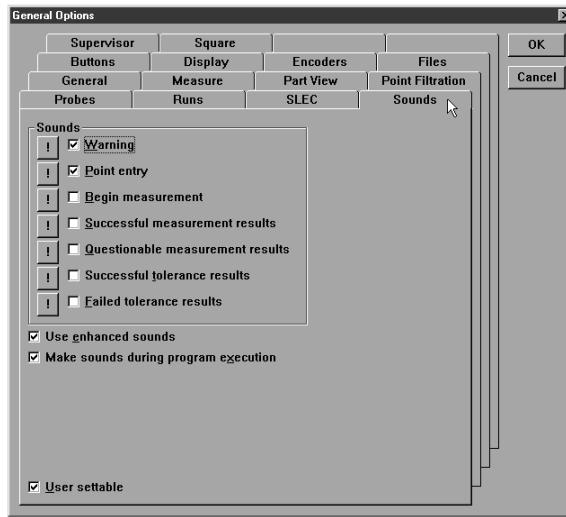

Use the *sound* tab to toggle on/off various system sounds. Place a check beside any item to enable the sound.

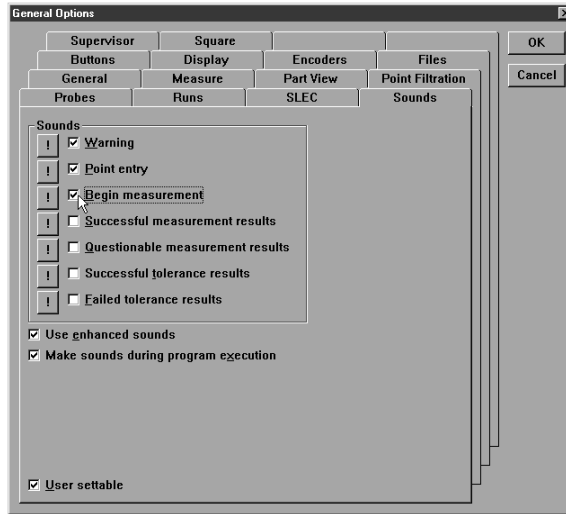

Preview sounds by clicking on the exclamation point as shown.

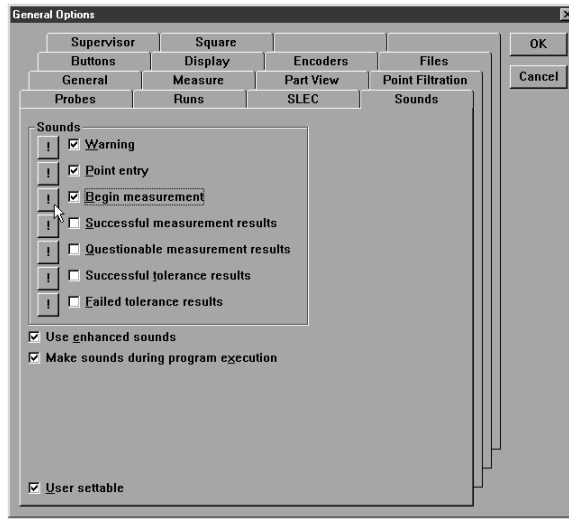

Check *make sounds during program execution* to enable sounds while running a parts program.

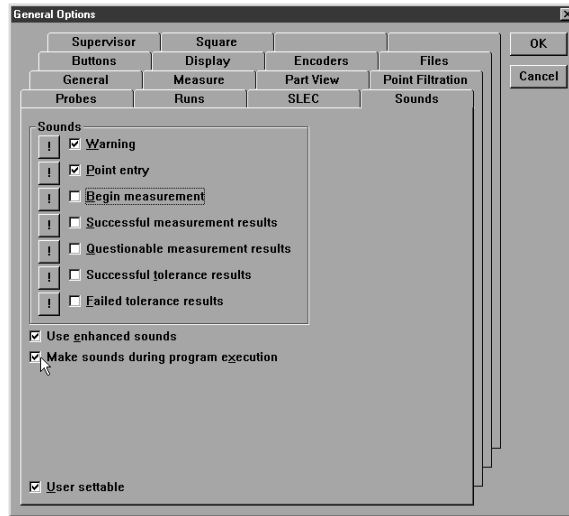



**Square**

Use the square tab to correct for small deviations from ‘squareness’ in the geometry of the CMM.

**To test for squareness**



**Use a bar-ball standard to perform this test.**

Step 1

Disable (uncheck) current squareness correction as shown.

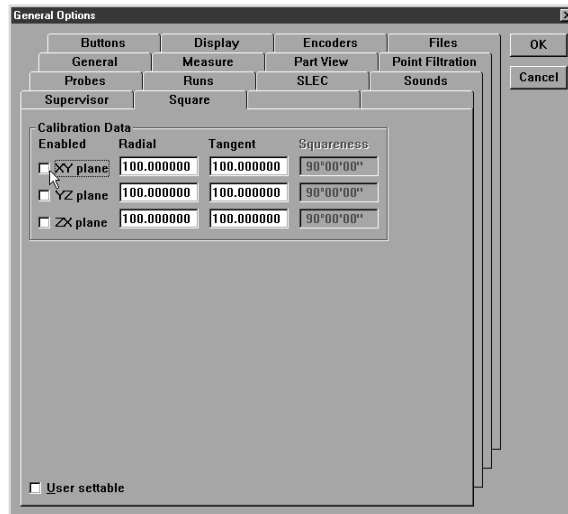

Step 2

Place the bar-ball on the XY plane of the CMM at angle 45 degrees to the X axis.

Step 3

Measure the length of the bar-ball.

Step 4

Place the bar-ball on the XY plane of the CMM at angle 135 degrees to the X axis.

Step 5

Measure the length of the bar-ball.



**Use this procedure to test squareness of each plane (XY, YZ, and ZX).**

Compare the two measurement results. Results that vary significantly indicate the axes are out square.

### To square axes

#### Step 1

Enter the length of the bar-ball at the 45 degree orientation in the radial text box for the XY plane.

#### Step 2

Enter the length of the bar-ball at the 135 degree orientation in the tangent text box for the XY plane.



#### NOTE

**Use the same procedure to square the other axes.**

# Index

## A

- absolute distance 132
- Alternate Datums 184**
- Angle 128. See also Relations**
- Angle Constructions 151**
  - angle from 2 linear features 151
- Arcs 74**
  - To probe an arc 74
- Arithmetic Operators 318. See also Programming**
- Auto Enter 47**
  - auto enter button 44
- Automated Text Input & Prompting 249**

## B

- bounded line distance from 2 lines 143
- Buttons**
  - To remove buttons to a toolbar 32

## C

- CAD files 154**
- Cardinal probe compensation 45**
  - cardinal probe compensation button 44
  - center to center distance 133
  - center to plane distance from a sphere 140
- Changing Probes 55**
- Circles 75**
  - To probe a circle 75
- Cones**
  - To probe a cone 78
- Constructing Features 81**
  - Angle Constructions 151**
    - To construct an angle from 2 linear features 151
  - Circle Constructions 115**
    - To change the location of a tangent circle 120
    - To construct a circle from a cone 116
    - To construct a circle from a sphere

- 115
- To construct a circle from an intersecting cylinder 118
- To construct a circle from an intersecting plane a 117
- To construct a circle tangent to 2 intersecting li 119
- Cone Constructions 127**
  - To construct a cone from 2 co-axial circles 127
- Cylinder Constructions 126**
  - To construct a cylinder from to 2 co-axial circles 126
- Distance Constructions 129**
  - To construct a bounded line distance from 2 lines 143
  - To construct a center to center distance 133
  - To construct a center to plane distance from a sph 140
  - To construct a distance between 2 co-axial planes 150
  - To construct a distance from a positional feature 136, 139
  - To construct a duplicate distance 130
  - To construct a farthest bounded line distance from 146
  - To construct a farthest edge distance 134
  - To construct a nearest bounded line distance from 144
  - To construct a nearest edge distance 135
  - To construct a reverse direction distance 131
  - To construct an absolute distance 132
  - To construct an unbounded distance from 2 linear f 148
  - To construct the farthest plane distance from a sp 142
  - To construct the farthest to line distance 138
  - To construct the length of an axis 129
  - To construct the nearest plane distance from a sph 141
  - To construct the nearest to line distance 137
- Line Constructions 95**
  - To construct a 2 point line from two positional fe 98
  - To construct a bisector of 2 linear features 102, 103
  - To construct a closest point of approach line fro 105

- To construct a gage line 112
- To construct a line by projecting an existing line 114
- To construct a line from a positional feature perp 107
- To construct a line from the intersection of 2 pla 101
- To construct a line parallel to a linear feature u 108
- To construct a midline from the sides of a slot 97
- To construct a perpendicular line through a plane 110
- To construct a plane axis line (Normal Line) 96
- To construct a rotated line from the leg of an ang 111
- To construct a tangent line from 2 radial position 99
- To construct an axis line from a linear feature 95
- Plane Constructions 121**
  - To construct a midplane from 2 planes 123
  - To construct a perpendicular midplane from 2 plane 124
  - To construct a plane from a line and a positional 122
  - To construct a plane from the midpoint of a line 121
- Point Constructions 81**
  - To construct a center point 81
  - To construct a closest point of approach point 87
  - To construct a midpoint from 2 positional features 91
  - To construct a midpoint from two circles 89
  - To construct a perpendicular point from a position 92
  - To construct a point from 2 intersecting lines 86
  - To construct a point from a linear feature and a p 93
  - To construct a point from the intersection of 3 pl 94
  - To construct a point from the intersection of a li 90
  - To construct an anchor point 84
  - To construct an apex point 82
  - To construct an application point 83
  - To construct bounding points 85
  - To construct point from intersecting circles 88
- Sphere Constructions 125**
  - To construct a sphere from a cone

## Index

---

125

### Cylinders

To probe a cylinder 79

## D

### Datum Magic 161

To create a datum using datum magic 161

### Datum Menu 24

### Datum toolbar 27

### Datums

Alternate Datums 184

To rotate the reference frame (datum) 184

### Distance 128. *See also* Relations

distance between 2 co-axial planes 150

distance from a positional feature to a plane 139

### DRO 8. *See also* Windows duplicate distance 130. *See also* Constructing Features: Distance Constructions: To construct a duplicate distance

## E

### Edit Menu 22

encoder resolution 358

### Encoder Setup 328

To setup encoders 328

Troubleshooting Encoder Setup 332

### Export 154, 156, 288

To export a CSV (comma separated value) file to a spreadsheet 288

To export to a CAD file 154

To export to SPC software 156

## F

farthest bounded line distance from 2 lines 146

farthest edge distance 134

farthest plane distance from a sphere 142

farthest to line distance 138

### Feature stamp 11

To open the feature stamp window 11

### Features Template 235. *See also* Templates: Features Template

To open the features template 235

### File Menu 22

### File toolbar 28

## G

### General Options 350, 352

buttons tab 352

display tab 355

encoders tab 358

To enter encoder resolution 360

files tab 376

general tab 361

measure tab 363

part view tab 368

point filtration tab 374

probes tab 370

To enter the diameter of a qualification sphere 371

SLEC tab 377

sound tab 385

square tab 387

To square axes 388

To test for squareness 387

To restrict access to general options tabs 350

## H

### HardProbe group 48

### Hardware Setup 327

### Help Menu 26

## L

### Layers 169

Displaying Layers 174

To assign a color to a layer 181

To assign features to new layers 172

To create a new layer 169

To hide a layer 174

To set a layer as current 170

To show a hidden layer 175

To turn off a layer 177

To turn on a layer 179

### Lines

To probe a line 73

### Locked/unlocked features 10

To lock a feature 10

To unlock a feature 10

## M

### Machine coordinates 68

### Machine Zero

To set machine zero 361

machine zero 33, 63

### Main Menu Bar 22

datum menu 24

edit menu 22

file menu 22

help menu 26

probe menu 25

tools menu 26

view menu 23

windows menu 26

### Master probe tips 52

### Measure Magic 163

To measure a circle 165

To measure a cone 166

To measure a cylinder 167

To measure a line 164

To measure a plane 165

To measure a point 163

To measure a sphere 168

To measure an arc 164

### Measure Menu 24

measure menu 24

### Measure toolbar 27

### Microsoft Access 158. *See also* Export: To export to Microsoft Access

## N

nearest bounded line distance from 2 lines 144

nearest edge distance 135

nearest plane distance from a sphere 141

nearest to line distance 137

### Nesting Template Windows 284. *See also* Templates: Nesting Template Windows

## O

### Offset Alignments 186. *See also* Alternate Datums

To perform an offset alignment (secondary line) 189

To perform an offset alignment (zero point) 192

To perform an offset alignment (primary plane) 186

### Overlays 250. *See also* Report Headers

To place an overlay in a report header 251

To save a report header as an overlay 250

**P**

- Part coordinates 68**
- Part View Window 12**
- Planes**
  - To probe a plane 77
- Points**
  - To probe a point 72
- Polar probe compensation 45**
- Probe Calibration 52**
  - To teach (qualify) a master probe tip 53
  - To teach (qualify) a non-master probe tip 54
- Probe compensation 45**
  - Cardinal probe compensation 44
  - Polar probe compensation 44
  - Probe compensation off 43
    - To activate probe compensation 46
- Probe compensation off 45**
  - probe compensation off button 43
- Probe Families & Groups 48**
- Probe Library 47**
  - Changing Probes 55
  - HardProbe group 48
  - Master probe tips 52
  - Probe Calibration 52
  - Probe Results Window 60
  - StarProbe group 49
    - To add probe tips 57
    - To change the current probe tip 55
    - To create a new probe group 50
    - To delete probe tips 59
    - To view the probes in a group 55
  - TouchProbe group 49
- Probe library 44**
  - probe library button 44
- Probe Menu 25**
- Probe Results Window 60**
  - probe teach button 43
- Probe Toolbar 43**
  - Auto enter 44
  - Cardinal probe compensation 44
  - Polar probe compensation 44
  - Probe compensation off 43
  - Probe library 44
  - Probe teach 43
- Probe toolbar 27**
- Probes**
  - Auto Enter 47
  - Auto enter 44
    - To activate auto enter 47
  - Cardinal probe compensation 44
  - Changing Probes 55

- Master probe tips 52
  - Polar probe compensation 44
  - Probe Calibration 52
  - probe compensation off 43
  - Probe library 44
  - probe teach 43
  - probing technique 43
  - Probing Technique 43**
  - Program Template 252. See also Templates**
    - To open the program template 252
  - Program Toolbar 294. See also Toolbars**
  - Program toolbar 27**
  - Programming 295**
    - Conditional Statements 317
    - Arithmetic Operators 318
    - Else Statement 321
    - Else-If Statement 322
    - If-Goto Statement 319
    - If-Then Statement 320
    - Running A Program 298
    - Sample Program 299
      - To record the sample program 299
      - To create a program 295
      - To open a saved program 297
    - User Messages 308
      - To Insert A User Message 308
  - Projection planes 67**
- R**
- Reference Frame 34, 66, 69**
    - To create a reference frame 69
  - Relations 128**
    - Angle 128
    - Distance 128
  - Report Headers 245. See also Templates: Reports Template**
    - Customizing Report Headers 247
      - To arrange text and graphics in a report header 248
      - To place a graphic in a report header 247
      - To show a report header 245
  - Reports Template 240. See also Templates: Reports Template**
    - reverse direction distance 131. *See also Constructing Features:*
      - Distance Constructions: To construct a reverse direction distance
  - Runs Template 282. See also**

**Templates: Runs Template**

**S**

- Saving Your Work 41, 152**
    - To export to a CAD file 154
    - To export to SPC software 156
    - To save a part file 152
  - SLEC (segmented linear error correction) 377**
    - To enter SLEC data 378
  - SLEC tab. See SLEC (segmented linear error correction)**
  - Slots**
    - To probe a slot 76
  - Sorting the Features List 239**
  - SPC software 156**
  - Spheres**
    - To probe a sphere 80
  - StarProbe group 49**
  - Starting The QC5000 5**
    - To open the QC5000 5
  - Status Bar 17**
    - To add items to the status bar 18
    - To delete items from the status bar 19
  - Supervisor Password 348**
    - To enter the supervisor password 348
- T**
- Template Features Dialog Box 255**
    - Display tab 255
    - Filters tab 260
      - To create a filter 261
      - To modify a filter 267
      - To remove a filter 269
    - Misc tab (miscellaneous) 270
  - Template Properties 254**
    - To access the template features dialog box 254
  - Template Windows 14**
  - Templates 233**
    - Adding Data to Templates 237
      - To drag and drop a multiple results window fields 238
    - Column Properties 271
    - Appearance tab 271
    - Column formulas 271
    - Formulas tab 271
    - Standard column properties 271
      - To create the sample formula 274
      - To modify a formula 279
      - To remove a formula 281
    - Creating New Templates 286

## Index

---

- To create a new template 286
- Features Template 235**
- Sorting the Features List 239**
  - To drag and drop a single results window field int 237
  - To open the features template 235
- Nesting Template Windows 284**
  - To nest template windows 284
  - To separate template windows 284
- Program Template 252**
- Reports Template 240**
- Adding Data to the Reports Template 242**
- Report Headers 245**
- Sorting Data in the Reports Template 244**
  - To drag and drop a multiple results window fields 243
  - To drag and drop a single results window field int 242
  - To open the reports template 240
  - To sort data in the reports template 244
- Runs Template 282**
  - To add data to the runs template 283
  - To open the runs template 282
- Three-dimensional features**
  - 3D Features 78**
    - To add buttons to a toolbar 30
    - To open the QC5000 5
    - To save a report header as an overlay 250
- Tolerance toolbar 27**
- Tolerancing 194**
  - Angle tolerance 229**
    - To perform an angle tolerance 229
  - Bi-directional tolerance (circles, points, arcs, s 196**
    - To perform a bi-directional tolerance 196
  - Circular runout tolerance 227**
    - To perform a circular runout tolerance 227
  - Circularity/sphericity tolerance (circles, spheres 213**
    - To perform a circularity tolerance 213
    - To perform a sphericity tolerance 215
  - Concentricity tolerance (circles, arcs) 208**
    - To perform a concentricity tolerance 208
  - Cylindricity tolerance (cylinders) 217**
    - To perform a cylindricity tolerance 217
  - Flatness tolerance (planes) 219**
    - To perform a flatness tolerance 219
  - MMC/LMC (maximum material condition/least material 202**
    - To perform a LMC 205
    - To perform a MMC tolerance 202
  - Parallelism/Co-planarity tolerance (linear feature 223**
    - To perform a co-planarity tolerance 225
    - To perform a parallelism tolerance 223
  - Perpendicularity tolerance (lines, cylinders, cone 221**
    - To perform a perpendicularity tolerance 221
  - Straightness tolerance (lines) 211**
    - To perform a straightness tolerance (lines) 211
  - Tolerance Toolbar 194**
    - To view the tolerance toolbar 194
  - True position tolerance (circles, points arcs, sph 199**
    - To perform a true position tolerance 199
  - Width tolerance 231**
    - To perform a width tolerance 231
- Toolbars 6, 27**
  - datum toolbar 27
  - file toolbar 28
  - measure toolbar 27
  - probe toolbar 27
  - probing technique 43
  - Program Toolbar 294
    - Edit Steps button 309, 311
    - Else button 310, 311
    - Else-If button 310, 311
    - Goto Label button 310, 312
    - If-Goto button 309, 311
    - If-Then button 309, 311
    - New Run button 294
    - Offset Positions button 310, 312
    - Pause Program button 294
    - Program Comment button 309, 311
    - Record/Edit Program button 294
    - Run Just Current Step button 294
    - Run Program From Current Step button 294
    - Super Step button 310, 312
- Toggle Break Point 309, 310
- Program toolbar 27**
- program toolbar 27**
  - To add buttons to a toolbar 315
  - To add buttons to a toolbar 30
  - To place a toolbar on the QC5000 desktop 28
  - To remove a toolbar from the QC5000 desktop 29
  - To remove buttons to a toolbar 32
  - tolerance toolbar 27
  - view toolbar 27
- Tools Menu 26**
- TouchProbe group 49**
- U**
  - unbounded distance from 2 linear features 148
- User Messages 308. See also Programming**
- V**
  - View Menu 23**
  - View Rotator 13**
    - To use the view rotator 13
  - View toolbar 27**
- W**
  - Windows 6**
    - DRO 8
    - Part View Window 12
    - Results Window 8
      - To move information from the results window to the 9
    - Template Windows 14
      - To nest template windows 16
      - To separate template windows 14
  - Windows Menu 26**

# HEIDENHAIN

---

**DR. JOHANNES HEIDENHAIN GmbH**

Dr.-Johannes-Heidenhain-Straße 5

**83301 Traunreut, Germany**

☎ +49 8669 31-0

FAX +49 8669 5061

E-mail: [info@heidenhain.de](mailto:info@heidenhain.de)

---

**[www.heidenhain.de](http://www.heidenhain.de)**