



HEIDENHAIN



ND 7000 Demo

User's Manual
Turning

Digital Readout
Firmware Version 1235720.1.7.x

English (en)
11/2024

Table of contents

1	Fundamentals.....	7
1.1	Overview.....	8
1.2	Information on the product.....	8
1.2.1	Demo software for demonstration of the device functions.....	8
1.2.2	Demo software features.....	8
1.3	Intended use.....	8
1.4	Improper use.....	8
1.5	Notes on reading the documentation.....	8
1.6	Symbols and fonts used for marking text.....	9
2	Software Installation.....	11
2.1	Overview.....	12
2.2	Downloading the installation file.....	12
2.3	System requirements.....	12
2.4	Installing ND 7000 Demo in Microsoft Windows.....	13
2.5	Uninstalling ND 7000 Demo.....	15

3	Basic Operation.....	17
3.1	Overview.....	18
3.2	Using the touchscreen and input devices.....	18
3.2.1	Touchscreen and input devices.....	18
3.2.2	Gestures and mouse actions.....	18
3.3	General operating elements and functions.....	20
3.4	ND 7000 Demo – startup and shut-down.....	22
3.4.1	Starting ND 7000 Demo.....	22
3.4.2	Shutting down ND 7000 Demo.....	23
3.5	User login and logout.....	24
3.5.1	User login.....	24
3.5.2	User logout.....	24
3.6	Setting the language.....	24
3.7	User interface.....	25
3.7.1	User interface after start-up.....	25
3.7.2	Main menu of the user interface.....	25
3.7.3	Manual operation menu.....	27
3.7.4	MDI menu.....	28
3.7.5	Program run menu (software option).....	30
3.7.6	Programming menu (software option).....	31
3.7.7	File management menu.....	33
3.7.8	User login menu.....	34
3.7.9	Settings menu.....	35
3.7.10	Switch-off menu.....	36
3.8	Position display.....	36
3.8.1	Operating elements of the position display.....	36
3.8.2	Position display functions.....	37
3.9	Status bar.....	40
3.9.1	Operating elements of the status bar.....	41
3.9.2	Additional functions in Manual operation mode.....	42
3.10	OEM bar.....	42
3.10.1	Operating elements of the OEM bar.....	42

4	Software Configuration.....	43
4.1	Overview.....	44
4.2	Setting the language.....	44
4.3	Activating software options.....	44
4.4	Selecting the product version (optional).....	45
4.5	Selecting the Application.....	46
4.6	Copying the configuration file.....	46
4.7	Uploading the configuration data.....	47
5	Application Example.....	49
5.1	Overview.....	50
5.2	Logging in for the application example.....	50
5.3	Requirements.....	51
5.4	Setting up the lathe.....	54
5.4.1	Measuring the reference tool.....	55
5.4.2	Tool measurement.....	56
5.4.3	Finding the preset.....	57
5.5	Roughing the outside contour.....	58
5.6	Turning recesses.....	59
5.7	Finishing the outside contour.....	60

6 ScreenshotClient.....	61
6.1 Overview.....	62
6.2 Information about ScreenshotClient.....	62
6.3 Starting ScreenshotClient.....	63
6.4 Connecting ScreenshotClient with the demo software.....	63
6.5 Connecting ScreenshotClient with the unit.....	64
6.6 Configuring ScreenshotClient for taking screenshots.....	64
6.6.1 Configuring the storage location and file name for screenshots.....	64
6.6.2 Configuring the user interface language of screenshots.....	64
6.7 Creating screenshots.....	65
6.8 Exiting ScreenshotClient.....	66
7 Index.....	67
8 List of figures.....	69

1

Fundamentals

1.1 Overview

This chapter contains information about the product and this manual.

1.2 Information on the product

1.2.1 Demo software for demonstration of the device functions

ND 7000 Demo is a software application you can install on a computer independently of the device. ND 7000 Demo helps you to become familiar with, try out or present the functions of the device.

1.2.2 Demo software features

Because of the missing hardware environment the range of features of the demo software does not correspond to the complete functional range of the device. However, you can use the descriptions to familiarize yourself with the most important functions and the user interface.

1.3 Intended use

The products of the ND 7000 series are advanced digital readouts for use on manually operated machine tools. In combination with linear and angle encoders, digital readouts of this series return the position of the tool in more than one axis and provide further functions for operating the machine tool.

ND 7000 Demo is a software product for demonstration of the basic features of the ND 7000 series products. ND 7000 Demo may be used only for presentation, training or testing purposes.

1.4 Improper use

ND 7000 Demo is not intended for any use other than the intended use. Any use for other purposes is prohibited, specifically:

- For productive purposes in production systems
- As part of production systems

1.5 Notes on reading the documentation

Have you found any errors or would you like to suggest changes?

We are continuously striving to improve our documentation for you. Please help us by sending your suggestions to the following e-mail address:

userdoc@heidenhain.de

1.6 Symbols and fonts used for marking text

In these instructions the following symbols and fonts are used for marking text:

Depiction	Meaning
▶ ... > ...	Identifies an action and the result of this action Example: ▶ Tap OK > The message is closed
■ ... ■ ...	Identifies an item of a list Example: ■ TTL interface ■ EnDat interface ■ ...
Bold	Identifies menus, displays and buttons Example: ▶ Tap Shut down > The operating system shuts down. ▶ Turn the power switch off

2

**Software
Installation**

2.1 Overview

This chapter provides all of the information needed for downloading and properly installing ND 7000 Demo on a computer.

2.2 Downloading the installation file

Before you can install the demo software on a computer, you need to download an installation file from the HEIDENHAIN Portal.

i To download the installation file from the HEIDENHAIN Portal, you need access rights to the Portal's **Software** folder in the directory of the appropriate product.

If you do not have access rights to the Portal's **Software** folder, you can request the access rights from your HEIDENHAIN contact person.

- ▶ Download the latest version of ND 7000 Demo here: <https://portal.heidenhain.de>
- ▶ Select the download folder of your browser
- ▶ Unpack the downloaded file with the extension **.zip** into a temporary storage folder
- > The following files will be unpacked into the temporary storage folder:
 - Installation file with the extension **.exe**
 - File **DemoBackup.mcc**

2.3 System requirements

If you want to install ND 7000 Demo on a computer, the computer system must meet the following requirements:

- Microsoft Windows 7 or higher
- Screen resolution of at least 1280 × 800 recommended

2.4 Installing ND 7000 Demo in Microsoft Windows

- ▶ Select the temporary storage folder into which you unpacked the downloaded file with the **.zip** extension
Further information: "Downloading the installation file", Page 12
- ▶ Run the installation file with the extension **.exe**
- ▶ The installation wizard is opened:



Figure 1: **Installation wizard**

- ▶ Click **Next**
- ▶ In the **License Agreement** installation step, accept the terms of the license
- ▶ Click **Next**



In the **Select Destination Location** installation step, the installation wizard suggests a storage location. We recommend retaining the suggested storage location.

- ▶ In the **Select Destination Location** installation step, select the storage location to which you want to save ND 7000 Demo
- ▶ Click **Next**

i In the **Select Components** installation step, the ScreenshotClient program is also installed by default. ScreenshotClient enables you to take screenshots of the active screen.

If you want to install ScreenshotClient

- ▶ In the **Select Components** installation step, leave the default settings unchanged

Further information: "ScreenshotClient", Page 61

- ▶ In the **Select Components** installation step:
 - Select the type of installation
 - Activate or deactivate the option **Screenshot Utility**

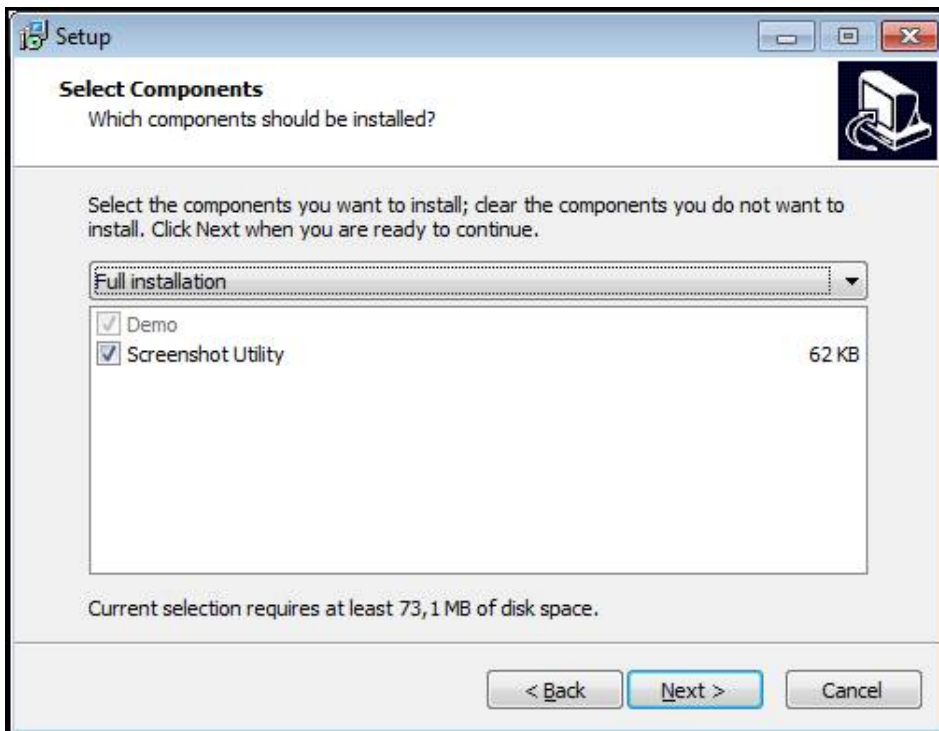

Figure 2: Installation wizard with activated options **Demo software** and **Screenshot Utility**

- ▶ Click **Next**
- ▶ In the **Select Start Menu Folder** installation step, select the storage location at which you want to create the start menu folder
- ▶ Click **Next**
- ▶ In the **Select Additional Tasks** installation step, select or deselect **Desktop icon**
- ▶ Click **Next**
- ▶ Click **Install**
- > Installation starts—the status of installation is shown in the progress bar.
- ▶ After installation has been completed successfully, use **Finish** to close the installation wizard
- > The program has been successfully installed on your computer.

2.5 Uninstalling ND 7000 Demo

- ▶ Click into the search window of the Windows task bar
- ▶ Enter "Remove" as the search term
- ▶ Click these elements in succession:
 - **Adding or removing programs**
 - **ND 7000 Demo**
 - **Uninstalling**
- ▶ Follow the instructions of the wizard
- > The program has been successfully removed from your computer.

3

Basic Operation

3.1 Overview

This chapter describes the user interface, operating elements, and basic functions of ND 7000 Demo.

3.2 Using the touchscreen and input devices

3.2.1 Touchscreen and input devices

The operating elements on the user interface of ND 7000 Demo are operated via a touchscreen or a connected mouse.

To enter data, you can use the screen keyboard of the touchscreen or a connected keyboard.

3.2.2 Gestures and mouse actions

To activate, switch or move the operating elements of the user interface, you can use ND 7000 Demo's touchscreen or a mouse. Gestures are used to operate the touchscreen and the mouse.

i The gestures for operating the touchscreen may differ from the gestures for operating the mouse.
 If the gestures for operating the touchscreen differ from those for operating the mouse, then these instructions describe both operating options as alternative actions.
 The alternative actions for operating the touchscreen or the mouse are identified by the following symbols:



Operation using the touchscreen



Operation using the mouse

The following overview describes the different gestures for operating the touchscreen or the mouse:

Tapping



Means touching the screen briefly with your fingertip



Means pressing the left mouse button once

The actions initiated by tapping include

- Selection of menus, features, or parameters
- Entering characters with the screen keyboard
- Closing dialogs

Holding (long press)



Means touching the screen and holding your finger(s) on it for a few seconds



Means pressing the left mouse button once and holding it down

The actions initiated by holding are

- Quickly changing the values in input fields with plus and minus buttons
- Activate multiple selection

Dragging



Is a combination of long press and then swipe, moving a finger over the touchscreen when at least the starting point of motion is defined



Means pressing the left mouse button once and holding it down while moving the mouse; at least the starting point of the motion is defined

The actions initiated by dragging include

- Scrolling through lists and texts

3.3 General operating elements and functions

The operating elements described below are available for configuring and operating the product via the touchscreen or input devices.



Screen keyboard







The screen keyboard enables you to enter text into the input fields of the user interface. Depending on the input field, a numeric or alphanumeric screen keyboard is shown.

Using the screen keyboard

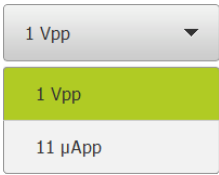
- ▶ To enter values, tap an input field
- > The input field is highlighted.
- > The screen keyboard is displayed.
- ▶ Enter text or numbers
- > If the entry is correct and complete, a green check mark is displayed as applicable.
- > If the entry is incomplete or the values are incorrect, a red exclamation mark is displayed as applicable. In this case, the entry cannot be completed.
- ▶ To apply the values, confirm the entry with **RET**
- > The values are displayed
- > The screen keyboard disappears.

Operating elements

Operating element	Function
	<p>Input fields with plus and minus buttons</p> <p>To adjust a numerical value, use the + (plus) and - (minus) buttons to the left and right of the numerical value.</p> <ul style="list-style-type: none"> ▶ Tap + or - until the desired value is displayed ▶ Long-press + or - to scroll through the values more quickly > The selected value is displayed.
	<p>Toggle switch</p> <p>Use the toggle switch to switch between functions.</p> <ul style="list-style-type: none"> ▶ Tap the desired function > The active function is shown in green. > The inactive function is shown in light gray.
	<p>Slide switch</p> <p>Use the slide switch to activate or deactivate a function.</p> <ul style="list-style-type: none"> ▶ Drag the slider to the desired position or ▶ Tap the slide switch > The function is activated or deactivated.

Operating element	Function
	<p>Drop-down list</p> <p>Buttons that open drop-down lists are indicated by a triangle pointing down.</p> <ul style="list-style-type: none"> ▶ Tap the button > The drop-down list opens. > The active entry is highlighted in green. ▶ Tap the desired entry > The selected entry is applied.
	<p>Undo</p> <p>This button allows you to undo the last action.</p> <p>Processes that have already been concluded cannot be undone.</p> <ul style="list-style-type: none"> ▶ Tap Undo > The last action is undone.
	<p>Add</p> <ul style="list-style-type: none"> ▶ Tap Add to add a feature > The new feature is added.
	<p>Close</p> <ul style="list-style-type: none"> ▶ Tap Close to close a dialog
	<p>Confirm</p> <ul style="list-style-type: none"> ▶ Tap Confirm to conclude an action
	<p>Back</p> <ul style="list-style-type: none"> ▶ Tap Back to return to the higher level in the menu structure

3.4 ND 7000 Demo – startup and shut-down

3.4.1 Starting ND 7000 Demo

i Before using ND 7000 Demo, you need to perform the steps for configuring the software.

ND

- ▶ Tap **ND 7000 Demo** on the Microsoft Windows desktop or
- ▶ Open the following in sequence in Microsoft Windows:
 - **Start**
 - **All programs**
 - **HEIDENHAIN**
 - **ND 7000 Demo**

i

Two executable files with different modes of appearance are available:

- **ND 7000 Demo**: starts within a Microsoft Windows window
- **ND 7000 Demo (full screen)**: starts in full-screen mode

ND

- ▶ Tap **ND 7000 Demo** or **ND 7000 Demo (full screen)**
- ND 7000 Demo starts an output window in the background. The output window is not relevant for operation and is closed again when the ND 7000 Demo is shut down.
- ND 7000 Demo starts the user interface with the **User login** menu.

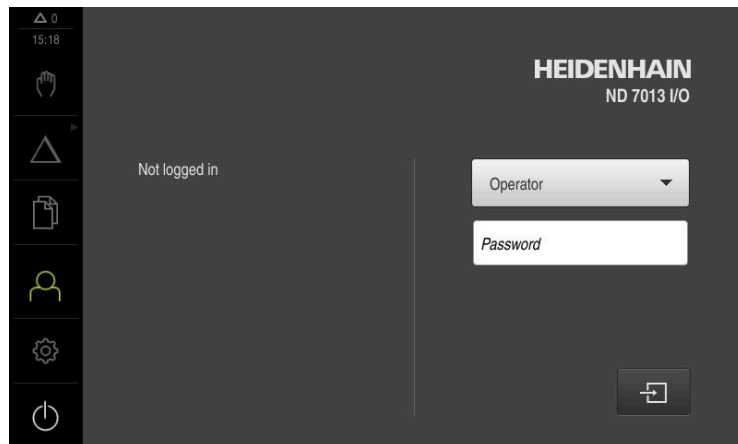

Figure 3: **User login** menu

3.4.2 Shutting down ND 7000 Demo



- ▶ Tap **Switch off** in the main menu



- ▶ Tap **Shut down**
- > ND 7000 Demo is shut down



To shut down ND 7000 Demo in the Microsoft Windows window, also use the **Switch-off** menu.

If you use **Close** to close the Microsoft Windows window, all settings will be lost.

3.5 User login and logout

In the **User login** menu, you can log in and out of the product as a user.

Only one user can be logged in to the product at a time. The logged-in user is displayed. Before a new user can log in, the logged-in user has to log out.



The product provides various authorization levels that grant the user full or restricted access to management and operation functionality.

3.5.1 User login



- ▶ Tap **User login** in the main menu
- ▶ In the drop-down list, select the **OEM** user
- ▶ Tap the **Password** input field
- ▶ Enter the "oem" password of the **OEM** user
- ▶ Confirm entry with **RET**



- ▶ Tap **Log in**
- > The user is logged in and the is displayed.

3.5.2 User logout



- ▶ Tap **User login** in the main menu



- ▶ Tap **Log out**
- > The user is logged out.
- > All functions of the main menu are inactive, except for **Switch off**.
- > The product can only be used again after a user has logged in.

3.6 Setting the language

The user interface language is English. You can change to another language, if desired.



- ▶ Tap **Settings** in the main menu



- ▶ Tap **User**
- > The logged-in user is indicated by a check mark.
- ▶ Select the logged-in user
- > The language selected for the user is indicated by a national flag in the **Language** drop-down list.
- ▶ Select the flag for the desired language from the **Language** drop-down list
- > The user interface is displayed in the selected language.

3.7 User interface

3.7.1 User interface after start-up

User interface after start-up

If automatic user login is activated, and the last user who logged in was of the **Operator** type, then the product displays the **Manual operation** menu after starting up.

If automatic user login is not activated, then the product opens the **User login** menu.

Further information: "User login menu", Page 34

3.7.2 Main menu of the user interface



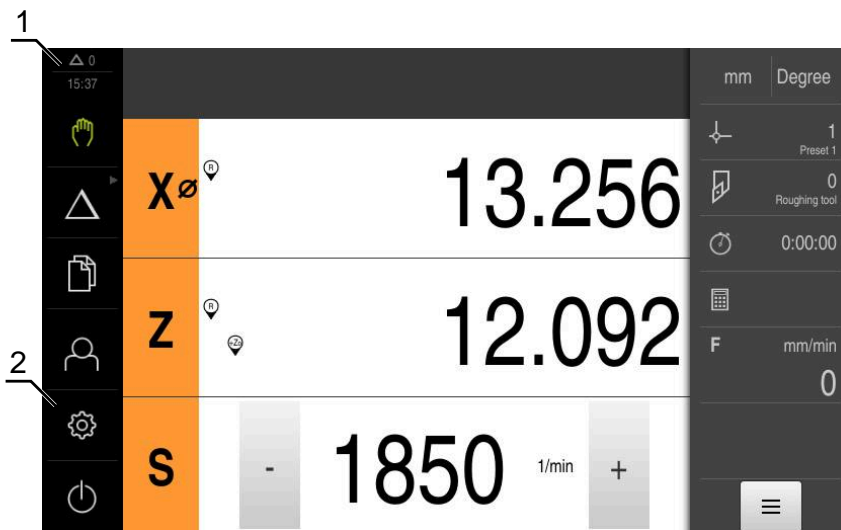



User interface (in Manual operation mode)



- 1 Message display area, displays the time and the number of unclosed messages
- 2 Main menu with operating elements

Main menu operating elements

Operating element	Function
	Message Displays an overview of all messages and the number of messages that have not been closed
	Manual operation Manual positioning of machine axes Further information: "Manual operation menu", Page 27
	MDI mode Direct input of the desired axis movements (Manual Data Input); the distance to go is calculated and displayed Further information: "MDI menu", Page 28
	Program run (software option) Execution of a previously created program with user interface Further information: "Program run menu (software option)", Page 30

Operating element	Function
	<p>Programming (software option)</p> <p>Creation and management of individual programs</p> <p>Further information: "Programming menu (software option)", Page 31</p>
	<p>File management</p> <p>Management of the files that are available on the product</p> <p>Further information: "File management menu", Page 33</p>
	<p>User login</p> <p>Login and logout of the user</p> <p>Further information: "User login menu", Page 34</p>
	<div style="border: 1px solid black; padding: 5px;"> <p> If a user with additional permissions (Setup or OEM user type) is logged in, then the gear symbol appears.</p> </div>
	<p>Settings</p> <p>Settings of the product, such as setting up users, configuring sensors, or updating the firmware</p> <p>Further information: "Settings menu", Page 35</p>
	<p>Switch-off</p> <p>Shutdown of the operating system or activation of power-saving mode</p> <p>Further information: "Switch-off menu", Page 36</p>

Selecting grouped operating elements

When **Software-Option ND 7000 PGM** is activated, the following operating elements are grouped in the main menu:

- **MDI mode**
- **Program run**
- **Programming**

 You can identify grouped operating elements by an arrow.



- ▶ To select an operating element from the group, tap the operating element with the arrow (e.g., tap **MDI mode**)
- > The operating element is shown as active.



- ▶ Tap the operating element again
- > The group opens.
- ▶ Select the desired operating element
- > The selected operating element is shown as active.

3.7.3 Manual operation menu

Call



- ▶ Tap **Manual operation** in the main menu
- > The user interface for Manual operation appears.

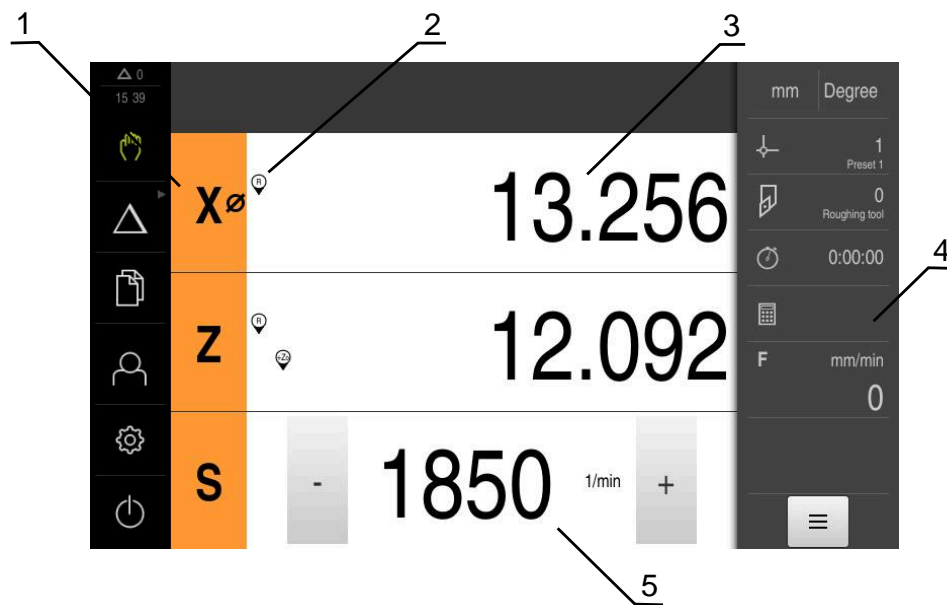

Figure 4: **Manual operation** menu

- 1 Axis key
- 2 Reference
- 3 Position display
- 4 Status bar
- 5 Spindle speed (machine tool)

In the **Manual operation** menu, the workspace shows the position values measured at the machine axes.

The status bar provides auxiliary functions.

3.7.4 MDI menu

Call



- ▶ Tap **MDI** in the main menu



The operating element can belong to a group (based on the configuration).

Further information: "Selecting grouped operating elements", Page 26

- > The user interface for MDI mode is displayed.

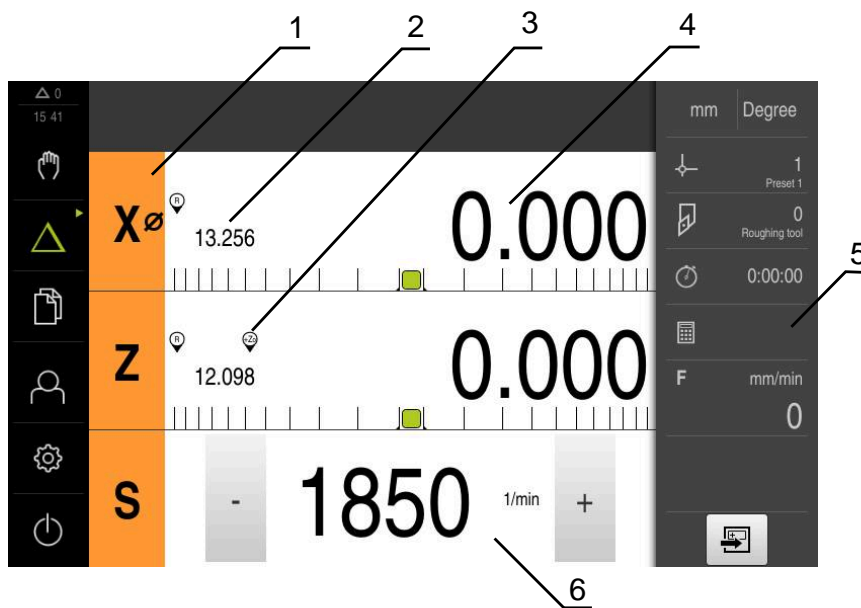

Figure 5: **MDI** menu

- 1 Axis key
- 2 Actual position
- 3 Coupled axes
- 4 Distance-to-go
- 5 Status bar
- 6 Spindle speed (machine tool)

MDI block dialog box

- ▶ Tap **MDI** in the main menu



The operating element can belong to a group (based on the configuration).

Further information: "Selecting grouped operating elements", Page 26



- ▶ Tap **Create** on the status bar
- ▶ The user interface for MDI mode is displayed.

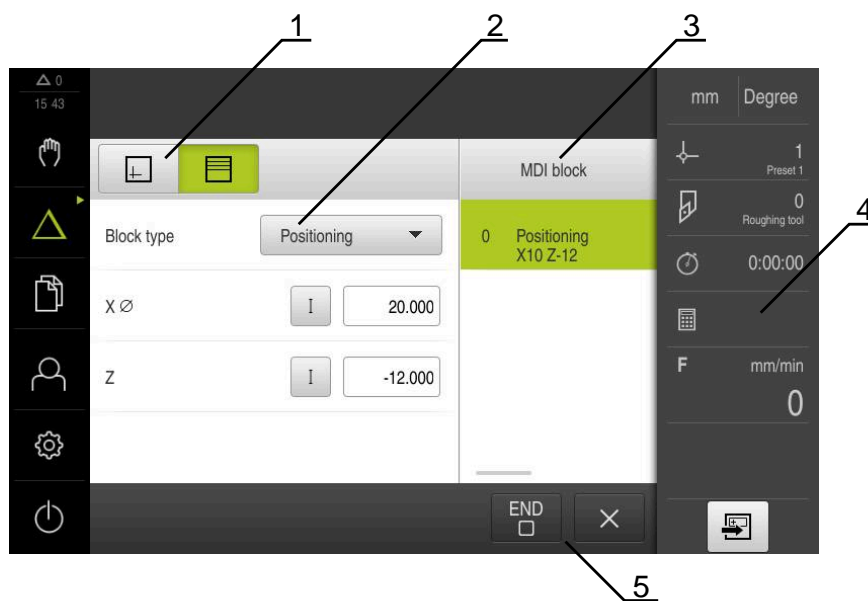

Figure 6: **MDI block** dialog box

- 1 View bar
- 2 Block parameters
- 3 MDI block
- 4 Status bar
- 5 Block tools

The **MDI** (Manual Data Input) menu enables you to enter the desired axis movements directly. You specify the distance to the target point, and the distance to go is then calculated and displayed.

The status bar provides additional measured values and functions.

3.7.5 Program run menu (software option)

Call



- ▶ Tap **Program run** in the main menu



The operating element belongs to a group.

Further information: "Selecting grouped operating elements", Page 26

- The user interface for Program Run is displayed.



Figure 7: **Program run** menu

- 1 View bar
- 2 Status bar
- 3 Program control
- 4 Spindle speed (machine tool)
- 5 Program management

The **Program run** menu makes it possible to execute a program that has previously been created in the Programming operating mode. During execution, a wizard will guide you through the individual program steps.

In the **Program run** menu, you can display a simulation window that visualizes the selected block.

The status bar provides additional measured values and functions.

3.7.6 Programming menu (software option)

Call



- ▶ Tap **Programming** in the main menu



The operating element belongs to a group.

Further information: "Selecting grouped operating elements", Page 26

- > The user interface for programming is displayed.



The status bar and the optional OEM bar are not available in the **Programming** menu.

You can see a visualization of the selected block in the optional simulation window.

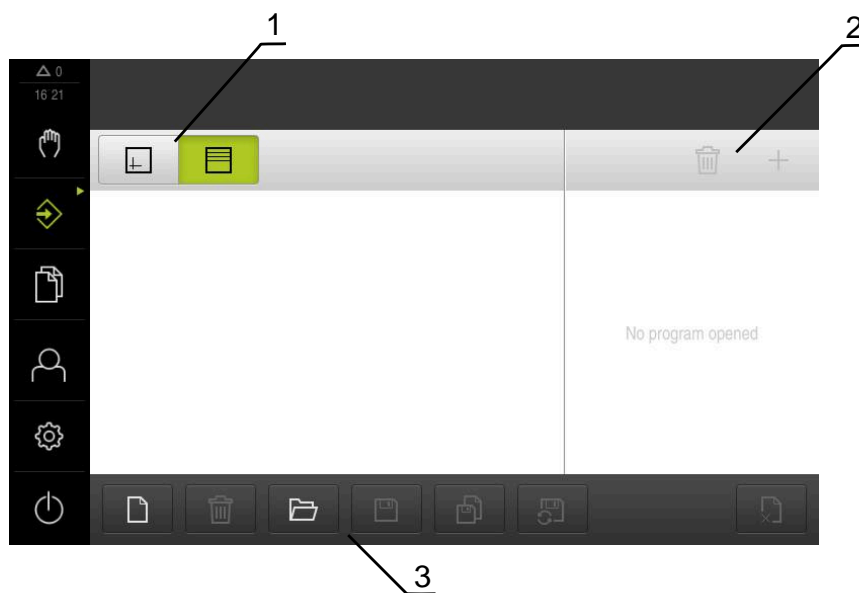

Figure 8: **Programming** menu

- 1 View bar
- 2 Toolbar
- 3 Program management

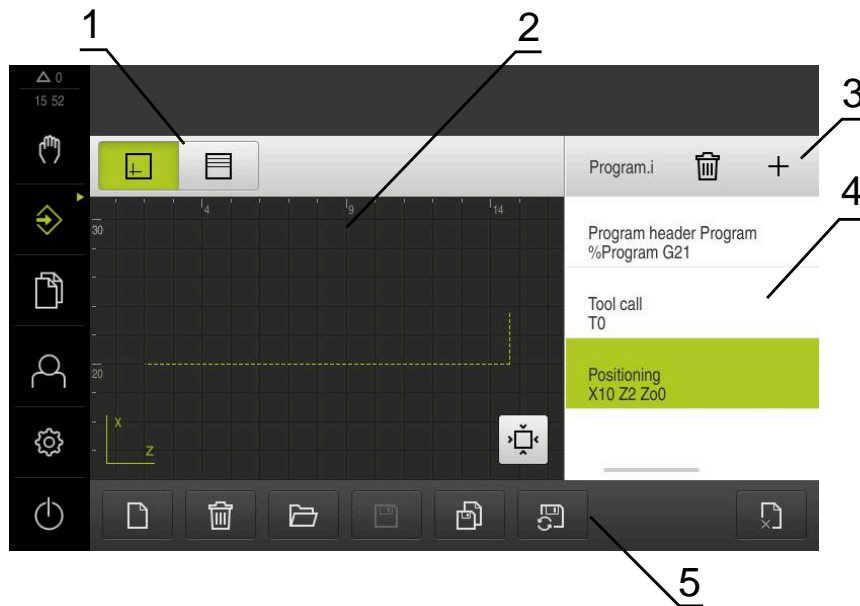

Figure 9: **Programming** menu with opened simulation window

- 1 View bar
- 2 Simulation window (optional)
- 3 Toolbar
- 4 Program blocks
- 5 Program management

In the **Programming** menu, you can create and manage programs. You define individual machining steps or machining patterns as blocks. A sequence of blocks then forms a program.

3.7.7 File management menu

Call



- ▶ Tap **File management** in the main menu
- > The file management user interface is displayed.

Short description

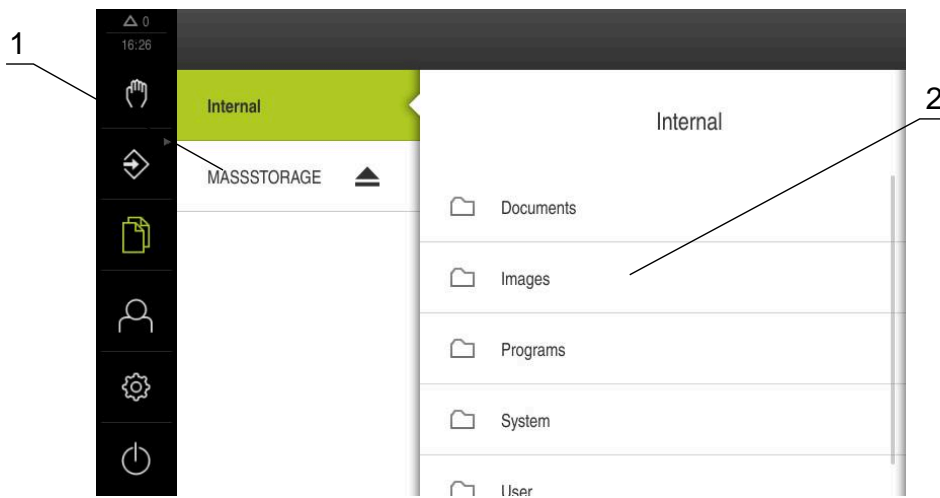

Figure 10: **File management** menu

- 1 List of available storage locations
- 2 List of folders in the selected storage location

The **File management** menu shows an overview of the files stored in the product's memory.

3.7.8 User login menu

Call



- ▶ Tap **User login** in the main menu
- > The user interface for user login and logout is displayed.

Short description

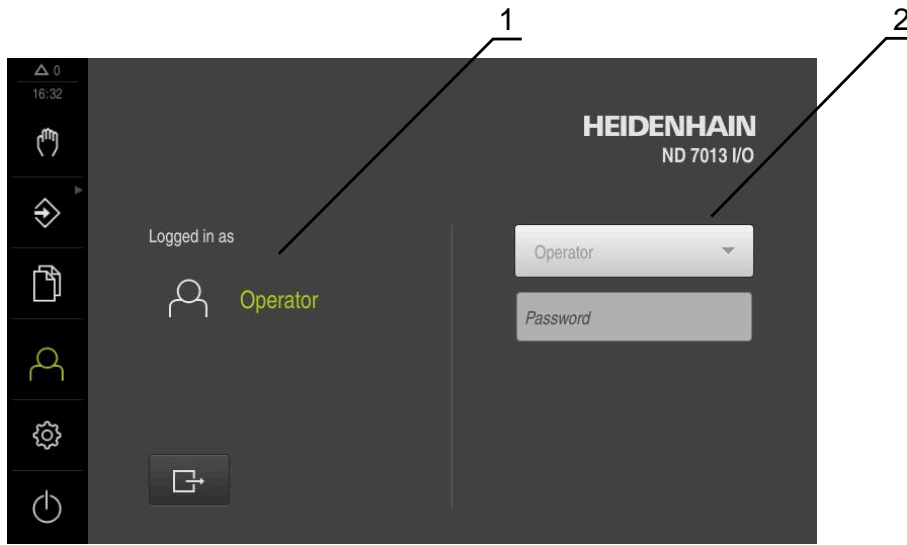

Figure 11: **User login** menu

- 1 Display of the logged-in user
- 2 User login

The **User login** menu shows the logged-in user in the column on the left. The login of a new user is displayed in the right-hand column.

To log in another user, the logged-in user must first log out.

Further information: "User login and logout", Page 24

3.7.9 Settings menu

Call



- ▶ Tap **Settings** in the main menu
- The user interface for the product settings is displayed.

Short description

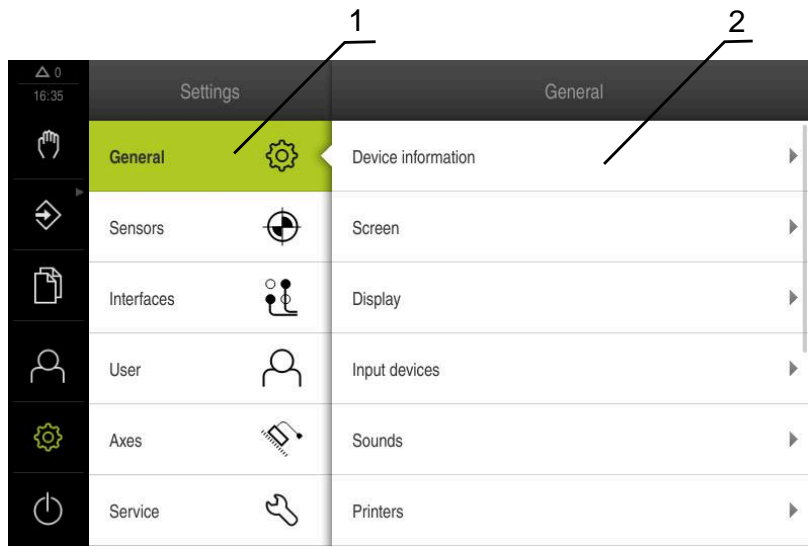

Figure 12: **Settings** menu

- 1 List of setting options
- 2 List of setting parameters

The **Settings** menu shows all of the options for configuring the product. The settings parameters allow you to adapt the product to on-site requirements.

i The product provides various authorization levels that grant the user full or restricted access to management and operation functionality.

3.7.10 Switch-off menu

Call



- ▶ Tap **Switch off** in the main menu
- The operating elements for shutting down the operating system, for activating the energy-saving mode and for activating the cleaning mode are displayed.

Short description

The **Switch off** menu provides the following options:

Operating element	Function
	Shut down Shuts down ND 7000 Demo
	Energy saving mode Switches the screen off and puts the operating system into energy-saving mode
	Cleaning mode Switches the screen off; the operating system continues unchanged

Further information: "ND 7000 Demo – startup and shut-down", Page 22









3.8 Position display

The unit's position display shows the axis positions and additional information about the configured axes (if applicable).

You can also couple the display of axes and have access to the spindle functions.

3.8.1 Operating elements of the position display

Symbol	Meaning
	Axis key Axis key functions: <ul style="list-style-type: none"> ■ Tapping the axis key: opens the input field for position value (Manual operation) or dialog box MDI block (MDI mode) ■ Holding down the axis key: sets the current position as zero point ■ Dragging the axis key to the right: opens menu if functions are available for the axis
	Position display shows the diameter of the radial machining axis X
	Reference mark search performed successfully
	Reference mark search not performed or no reference mark detected

Symbol	Meaning
	Zo axis is coupled with the Z axis. Position display shows the sum of both position values Further information: "Coupling axes", Page 37
 Only the Zo axis can be coupled to the Z axis.	
	Selected gear stage of the gear spindle Further information: "Setting the gear stage for gear spindles", Page 39
	Spindle speed cannot be achieved with selected gear stage ▶ Select a higher gear stage
	Spindle speed cannot be achieved with selected gear stage ▶ Select a lower gear stage
	The CSS (constant surface speed) spindle mode is activated Further information: "Setting the spindle mode", Page 40 If the icon is flashing, then the calculated spindle speed lies outside of the defined speed range. The desired surface speed cannot be attained. The spindle will continue to turn at the maximum or minimum speed
	In MDI mode and Program Run , a scaling factor is applied to the axis
1250 <small>1/min</small>	Actual spindle speed
	Input field for controlling the spindle speed Further information: "Setting the spindle speed", Page 38

3.8.2 Position display functions

Coupling axes

You can couple the display of the axes **Zo** and **Z**. For coupled axes, the position display in the **Z** axis shows the sum of the position values of both axes.

 If the **Z** axis and the **Zo** axis have been coupled, the Program run operating mode is disabled.

Coupling axes



- ▶ In the working space, drag the **Z axis key** to the right



- ▶ Tap **Couple**
- > The **Zo** axis is coupled with the **Z** axis.



- > The icon for the coupled axes appears next to the **axis key Z**.
- > The position value for the coupled axes is shown as a sum.

Decoupling axes



- ▶ In the working space, drag the **Z axis key** to the right



- ▶ Tap **Decouple**
- ▶ The shown sum value is applied to the **Z** axis.
- ▶ Axis **Z0** is set to 0.

Example: Coupling axes

The figure below shows the position values before, during and after coupling the axes **Z** and **Z0**.

X\emptyset	19.250		X\emptyset	19.250		X\emptyset	19.250
Z0	-5.000		Z	-15.000		Z0	0.000
Z	-10.000					Z	-15.000

Axes **Z0** and **Z** not coupled.

Z0 is coupled to axis **Z**.
The sum of both axes is shown in **Z**.

Z0 is decoupled from axis **Z**.
The sum continues to be shown in axis **Z**.
Axis **Z0** is set to 0.

Setting the spindle speed



The following information applies only to units with ID number 1089179-xx.

You can control the spindle speed depending on the configuration of the connected machine tool.

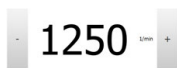

- ▶ To switch from the display of the spindle speed to the input field (if required), drag the display to the right.
- ▶ The **Spindle speed** input field is displayed.
- ▶ Tap or long-press **+** or **-** to set the spindle speed to the desired value
- or
- ▶ Tap the **Spindle speed** input field
- ▶ Enter the desired value
- ▶ Confirm entry with **RET**
- ▶ The product applies the entered spindle speed as the nominal value and controls the spindle of the machine tool accordingly.
- ▶ To return to the display of the actual spindle speed, drag the input field to the left



Setting the gear stage for gear spindles

 The following information applies only to units with ID number 1089179-xx.

If your machine tool uses a gear spindle, then you can select the gear stage used.

 The selection of the gear stages can also be controlled via an external signal.



▶ In the working space, drag the **S axis key** to the right



- ▶ Tap **Gear stage**
- > The **Set gear stage** dialog box appears.
- ▶ Tap the desired gear stage



- ▶ Tap **Confirm**
- > The selected gear stage is now adopted as the new value.
- ▶ Drag the **S axis key** to the left



- > The icon for the selected gear stage appears next to the **S axis key**.

 If the desired spindle speed cannot be attained with the selected gear stage, then the gear stage icon will flash with an upward pointing arrow (higher gear stage) or with a downward pointing arrow (lower gear stage).





Setting the spindle mode

 The following information applies only to units with ID number 1089179-xx.



For spindle mode, you can decide whether the product uses the standard speed mode or **CSS** (constant surface speed).

In the **CSS** spindle mode, the unit calculates the spindle speed such that the surface speed of the turning tool remains constant regardless of the workpiece geometry.

Activating the CSS spindle mode

-  ▶ In the working space, drag the **S axis key** to the right
-  ▶ Tap **CSS mode**
 - > The **Activate CSS** dialog box appears.
 - > Enter the value for **Maximum spindle speed**
-  ▶ Tap **Confirm**
 - > The **CSS** spindle mode is activated.
 - > The spindle speed is shown in the unit of measure **m/min**.
-  ▶ Drag the **S axis key** to the left
 - > The icon for the **CSS** spindle mode appears next to the **S axis key**.

Activating the speed mode

-  ▶ In the working space, drag the **S axis key** to the right
-  ▶ Tap **Speed mode**
 - > The **Activate speed mode** dialog box appears.
 - > Enter the value for **Maximum spindle speed**
-  ▶ Tap **Confirm**
 - > The speed mode is activated.
 - > The spindle speed is shown in the unit of measure **rpm**.
- ▶ Drag the **S axis key** to the left







3.9 Status bar

 The status bar and the optional OEM bar are not available in the **Programming** menu.

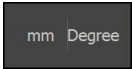
In the status bar, the product shows the feed rate and traversing speed. The operating elements of the status bar also give you direct access to the preset table and tool table, as well as to the stopwatch and calculator features.

3.9.1 Operating elements of the status bar

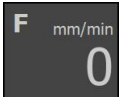
The status bar provides the following operating elements:

Operating element	Function
	Quick access menu Setting of the units for linear values and angular values, configuration of a scaling factor, configuration of the position display for radial machining axes; tapping opens the quick access menu
	Preset table Display of the current preset; tapping opens the preset table
	Tool table Display of the current tool; tapping opens the tool table
	Stopwatch Time display with Start / Stop function in h:mm:ss format
	Calculator Calculator with the most important mathematical functions, speed calculator and taper calculator
	Feed rate Display of the current feed rate of the fastest linear axis If all linear axes are at a standstill, the feed rate of the fastest rotational axis is shown
	Auxiliary functions Auxiliary functions in Manual operation mode
	MDI block For creating machining blocks in MDI mode

3.9.2 Additional functions in Manual operation mode



- ▶ To call the additional functions, tap **Additional functions** in the status bar

The following operating elements are available:

Operating element	Function
	Reference marks For starting the reference mark search
	Presets Setting presets
	Tool data For tool setting (touch-off)

3.10 OEM bar

i The status bar and the optional OEM bar are not available in the **Programming** menu.

Depending on the configuration, the optional OEM bar enables you to control the functions of the connected machine tool.

3.10.1 Operating elements of the OEM bar

i The operating elements that are available on the OEM bar depend on the configuration of the device and of the connected machine tool.

The following operating elements are typically available in the **OEM bar**:

Operating element	Function
	Tapping the tab shows or hides the OEM bar
	Logo Displays the configured OEM logo
	Spindle speed Shows one or more default values for the spindle speed

4

Software Configuration

4.1 Overview



Make sure that you have read and understood the "Basic Operation" chapter before carrying out the actions described below.

Further information: "Basic Operation", Page 17

Before you can use ND 7000 Demo correctly after successful installation, you need to configure ND 7000 Demo. This chapter describes how to perform the following settings:

- Setting the language
- Activating software options
- Selecting the product version (optional)
- Selecting the Application
- Copying the configuration file
- Uploading the configuration data

4.2 Setting the language

The user interface language is English. You can change to another language, if desired.



- ▶ Tap **Settings** in the main menu



- ▶ Tap **User**
- > The logged-in user is indicated by a check mark.
- ▶ Select the logged-in user
- > The language selected for the user is indicated by a national flag in the **Language** drop-down list.
- ▶ Select the flag for the desired language from the **Language** drop-down list
- > The user interface is displayed in the selected language.

4.3 Activating software options

With ND 7000 Demo, you can also simulate characteristics and functions that are dependent on a software option. To do so, you must enable the software option with a license key. To enable the available software options, you must create the license file and upload it.

Creating the license file



- ▶ Tap **Settings** in the main menu
- > The product settings are displayed.



- ▶ Tap **Service**
- ▶ Tap **Software options**
- ▶ Tap **Request options**
- ▶ Select the desired software option
- ▶ Tap **Creating a request**
- ▶ Select the desired storage location
- ▶ Tap **Save as**
- > The license file was created.

Reading the license file



- ▶ Tap **Settings** in the main menu
- > The product settings are displayed.



- ▶ Tap **Service**
- ▶ Tap **Software options**
- ▶ Tap **Activate options**
- ▶ Select the desired software option
- ▶ Tap **Creating a request**
- ▶ Tap **Read license file**
- ▶ Select the previously defined storage location and select the license file
- ▶ Confirm your selection with **Select**
- > The license key is activated.
- ▶ Tap **OK**
- > You are prompted to perform a restart.
- ▶ Perform a restart
- > The functions dependent on the software options are available

4.4 Selecting the product version (optional)

ND 7000 is available in different versions. These versions differ in their interfaces for connectible encoders:

- The ND 7013 version
- The ND 7013 I/O version with additional inputs and outputs for switching functions

In the **Settings** menu, you can select the version that is to be simulated with ND 7000 Demo



- ▶ Tap **Settings** in the main menu



- ▶ Tap **Service**
- ▶ Tap **Product designation**
- ▶ Select the desired version
- > You are prompted to perform a restart.
- > ND 7000 Demo is ready for use in the desired version.

4.5 Selecting the Application

The demo software allows you to simulate the various applications supported by the product.

 When you change the unit's application mode, then all of the axis settings will be reset.

Settings ▶ Service ▶ OEM area ▶ Settings

Parameter	Explanation
Application	<p>The type of application mode; a change becomes active after a restart</p> <p>Settings:</p> <ul style="list-style-type: none"> ■ Milling ■ Turning ■ Radial drilling (software option) <p>Default value: Milling</p>

4.6 Copying the configuration file

Before you can load the configuration data in ND 7000 Demo, you must first copy the downloaded configuration file **DemoBackup.mcc** to an area that can be accessed by ND 7000 Demo.

- ▶ Move to the temporary storage folder
- ▶ For example, copy the configuration file **DemoBackup.mcc** to the following folder: **C: ▶ HEIDENHAIN ▶ [product name] ▶ ProductsMGE5 ▶ Mom ▶ [product abbreviation] ▶ user ▶ User**

 In order for ND 7000 Demo to access the configuration file **DemoBackup.mcc**, you must retain the following part of the path when you save the file: **▶ [product name] ▶ ProductsMGE5 ▶ Mom ▶ [product abbreviation] ▶ user ▶ User.**

- > The configuration file can be accessed by ND 7000 Demo.

4.7 Uploading the configuration data

i Before you can upload the configuration data, you must first activate the license key.

Further information: "Activating software options", Page 44

In order to configure ND 7000 Demo for use on the computer, you must upload the **DemoBackup.mcc** configuration file.



- ▶ Tap **Settings** in the main menu
- > The product settings are displayed.

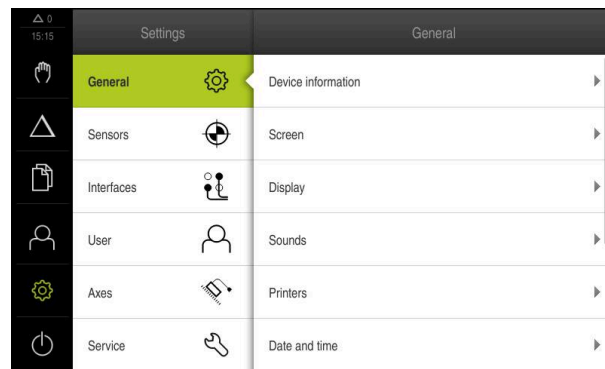

Figure 13: **Settings** menu



- ▶ Tap **Service**
- ▶ Open in succession:
 - **Back up and restore**
 - **Restoring settings**
 - **Complete restoration**
- ▶ In the dialog box, select the storage location:
 - **Internal**
 - **User**
- ▶ Select the **DemoBackup.mcc** configuration file
- ▶ Confirm your selection with **Select**
- > The settings are applied.
- > You are prompted to close the application.
- ▶ Tap **OK**
- > ND 7000 Demo is shut down, and the Microsoft Windows window is closed.
- ▶ Restart ND 7000 Demo
- > ND 7000 Demo is now ready for use.

5

Application Example

5.1 Overview

This chapter describes the production of an example workpiece. This chapter will guide you step by step through the unit's various machining options as you machine the example workpiece. For successful machining of the bearing seat you will need to perform the following machining steps:

Machining step	Mode of operation
Setting up the lathe	Manual operation
Roughing the outside contour	Manual operation
Turning the recesses	Manual operation
Finishing the outside contour	Manual operation

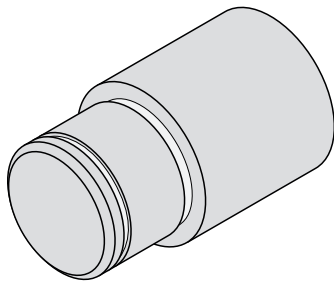

Figure 14: Example workpiece



Make sure that you have read and understood the "Basic Operation" chapter before carrying out the actions described below.

Further information: "Basic Operation", Page 17

5.2 Logging in for the application example

User login

For the application example, the **Operator** user must log in.



- ▶ Tap **User login** in the main menu
- ▶ If required, log out the user who is currently logged in
- ▶ Select the **Operator** user
- ▶ Tap the **Password** input field
- ▶ Enter the password "operator"



If a password other than the default password has been assigned to the user, ask a **Setup** or **OEM** user for the assigned password.

If the password is no longer known, contact a HEIDENHAIN service agency.

- ▶ Confirm entry with **RET**
- ▶ Tap **Log in**



5.3 Requirements

Use a manually operated lathe to machine the bearing seat. The following dimensioned technical drawing is available for the bearing seat:

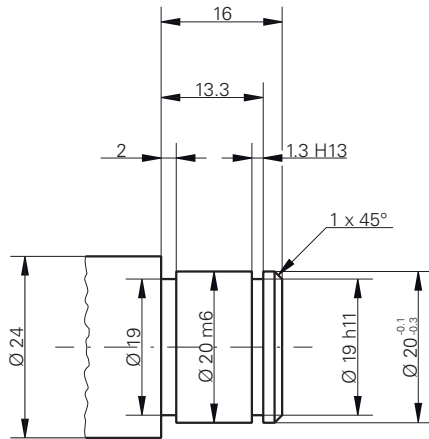

Figure 15: Example workpiece – technical drawing

Lathe

- The lathe is switched on
- A workpiece blank with $\varnothing 24$ mm is clamped into the lathe

Product

- The axes are referenced

Tools

The following tools are available:

Tool	Image
Roughing tool	
Finishing tool	
Recessing tool 1 mm	
Turning chisel (45°)	

Tool table

For the example it is presumed that the tools for machining are not yet defined. You must add in advance all of the tools to be used to the tool table.



- ▶ Tap **Tools** on the status bar
- > The **Tools** dialog box appears.



- ▶ Tap **Open table**
- > The **Tool table** dialog box appears.



- ▶ Tap **Add**
- ▶ Enter the designation **Finishing tool** in the **Tool type** input field
- ▶ Confirm your input with **RET**
- ▶ Enter the value **0** in the **X** input field
- ▶ Confirm your input with **RET**
- ▶ Enter the value **0** in the **Z** input field
- ▶ Confirm your input with **RET**
- > The defined finishing tool is added to the tool table.



- ▶ Repeat this process for the other tools
- ▶ Tap **Close**
- > The **Tool table** dialog is closed.

5.4 Setting up the lathe

In the first machining step, you will set up the lathe. The unit requires the parameters of the individual tools for the calculation for the relative coordinate system. In order to manufacture a workpiece, you will need one of the presets you defined.

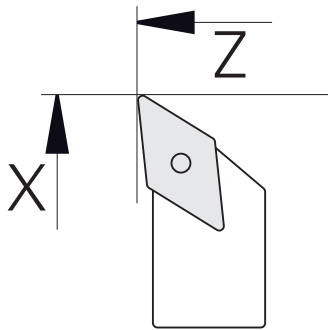

Figure 16: Finishing tool parameters

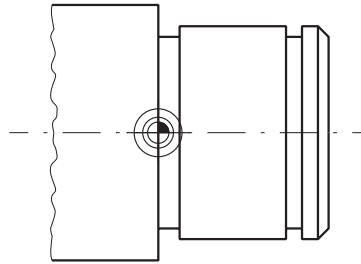

Figure 17: Preset

Call



- ▶ Tap **Manual operation** in the main menu
- The user interface for Manual operation appears.

Coupling axes



For a lathe with a **Z** saddle and a **Zo** top slide, you have the option of coupling both the **Z** and **Zo** axes.



- ▶ In the working space, drag the **Z axis key** to the right



- ▶ Tap **Couple**
- The **Zo** axis is coupled with the **Z** axis.



- The icon for the coupled axes appears next to the **axis key Z**.
- The position value for the coupled axes is shown as a sum.

5.4.1 Measuring the reference tool

For every tool used, determine the position of the cutting edges (for X and/or Z) in relation to the machine coordinate system or to the workpiece preset. To do so, first define a tool based on which all further parameters of the other tools are calculated. In this example, the finishing tool will be used as the reference tool.



- ▶ Insert the finishing tool into the tool holder
- ▶ Tap **Tools** on the status bar
- > The **Tools** dialog box appears.
- ▶ Tap **Finishing tool**



- ▶ Tap **Confirm**
- > The **finishing tool** is shown in the status bar.
- ▶ Set a spindle speed of 1500 rpm



- ▶ Tap **Auxiliary functions** in the status bar



- ▶ Tap **Tool data**
- > The **Set tool data** dialog box opens.
- ▶ Approach the workpiece blank with the finishing tool and perform a touch-off



- ▶ When the appropriate Z value is reached, tap **Save position**
- ▶ Perform face turning with the finishing tool
- ▶ Move the tool to a safe position
- ▶ In the **Z** input field, enter the value **0**



- ▶ Approach the workpiece blank with the finishing tool
- ▶ When the appropriate X value is reached, tap **Save position**
- ▶ Turn a step on the outside diameter of the workpiece blank using the finishing tool
- ▶ Move the tool to a safe position
- ▶ Spindle OFF



- ▶ Measure the turned outside diameter using an appropriate measuring tool
- ▶ Enter the measured value in the **X** input field



- ▶ Tap **Confirm** in the wizard
- > The **Select the tool** dialog box appears.
- ▶ Tap **Finishing tool**
- ▶ Tap **Confirm** in the wizard
- > The parameters are adopted in the tool table.

5.4.2 Tool measurement

You have already defined a finishing tool as the reference tool. For every additional tool, you must determine its offset from the reference tool. During measurement, the parameters of the measured tools are automatically offset from the parameters of the reference tool. The measured parameters are separate for each tool and are retained even after you have deleted the reference tool. In the example, the roughing tool is added as a tool.



- ▶ Insert the roughing tool into the tool holder
- ▶ Tap **Tools** on the status bar
- > The **Tools** dialog box appears.
- ▶ Tap **Roughing tool**



- ▶ Tap **Confirm**
- > The **roughing tool** is shown in the status bar.
- ▶ Set a spindle speed of 1500 rpm



- ▶ Tap **Auxiliary functions** in the status bar



- ▶ Tap **Tool data**
- > The **Set tool data** dialog box opens.
- ▶ Move the tool to the plane surface until tiny chips occur
- ▶ When the appropriate Z value is reached, tap **Save position**
- ▶ Move the tool to a safe position
- ▶ In the **Z** input field, enter the value **0**



- ▶ Approach the workpiece blank with the roughing tool
- ▶ When the appropriate X value is reached, tap **Save position**
- ▶ Turn a step on the outside diameter of the workpiece blank using the roughing tool
- ▶ Move the tool to a safe position
- ▶ Spindle OFF



- ▶ Measure the turned outside diameter using an appropriate means of measurement
- ▶ Enter the measured value in the **X** input field



- ▶ Tap **Confirm** in the wizard
- > The **Select the tool** dialog box appears.
- ▶ Tap **roughing tool**



- ▶ Tap **Confirm** in the wizard
- > The parameters are adopted in the tool table.
- ▶ Repeat this process for the other tools

5.4.3 Finding the preset

To machine the bearing seat, you will need to find the preset. According to the drawing, the dimensions are referenced to the mating surface of the bearing. In the drawing, the area is highlighted in green. Based on this preset the product then calculates all values for the relative coordinate system.

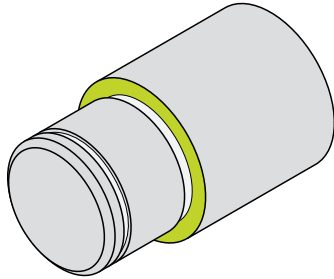



Figure 18: Example workpiece – finding the preset

- ▶  Insert the finishing tool into the tool holder
- ▶ Tap **Tools** on the status bar
- > The **Tools** dialog box appears.
- ▶ Tap **Finishing tool**
- ▶ Tap **Confirm**
- > The **finishing tool** is shown in the status bar.
- ▶ Tap **Auxiliary functions** in the status bar
- ▶ Tap **Presets** in the dialog
- > The **Set preset data** dialog box opens.
- ▶ On the workpiece blank, move the finishing tool along **Z** in the negative direction for approx. 17 mm
- ▶ Tap **Save position**
- > The current position of the tool is saved.
- ▶ Move the tool to a safe position
- ▶ In the **Z** input field, enter the value **0**
- ▶ Tap **Confirm** in the wizard
- > The **Select preset** dialog box appears.
- ▶ Select preset **0** in the **Selected preset** input field
- ▶ Tap **Confirm** in the wizard
- > The probed coordinate is loaded as preset.

5.5 Roughing the outside contour

In the second machining step, you will rough the outside contour. Turn the entire contour with a finishing allowance. A finishing allowance ensures that you will be able to produce a flawless surface using the finishing tool in the final machining step.

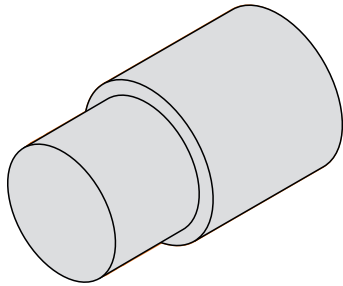

Figure 19: Example workpiece – roughing the outside contour



- ▶ Insert the roughing tool into the tool holder

- ▶ Tap **Tools** on the status bar

- > The **Tools** dialog box appears.

- ▶ Tap **Roughing tool**

- ▶ Tap **Confirm**

- > The associated tool parameters are applied automatically.

- > The **Tools** dialog is closed.

- ▶ Set a spindle speed of 1500 rpm

- ▶ Position the tool:

- X: 25.0 mm

- Z: 16.2 mm

- ▶ Perform the face-turning operation with the roughing tool

- ▶ Move the tool to a safe position

- ▶ Position the tool:

- X: 20.2 mm

- Z: 17.0 mm

- ▶ Position the tool:

- Z: 0.2 mm

- ▶ Position the tool:

- X: 25.0 mm

- ▶ Move the tool to a safe position

- ▶ Spindle OFF

- > You have successfully roughed the outside contour.



5.6 Turning recesses

In the third machining step, you will turn both recesses. One of the recesses serves as an undercut for the mating surface, and the second recesses will hold the securing ring.

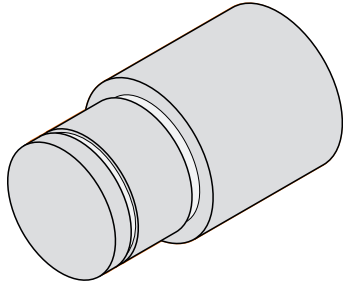

Figure 20: Example workpiece – turning recesses



- ▶ Insert the recessing tool into the tool holder

- ▶ Tap **Tools** on the status bar

- ▶ The **Tools** dialog box appears.

- ▶ Tap **Recessing tool 1 mm**

- ▶ Tap **Confirm**

- ▶ The associated tool parameters are applied automatically.

- ▶ The **Tools** dialog is closed.

- ▶ Set a spindle speed of 400 rpm

- ▶ Position the tool:

- X: 21.0 mm

- Z: 12.3 mm

- ▶ Position the tool:

- X: 18.935 mm

- ▶ Position the tool:

- X: 21.0 mm

- ▶ Position the tool:

- Z: 12.0 mm

- ▶ Position the tool:

- X: 18.935 mm

- ▶ Position the tool:

- X: 21.0 mm

- ▶ Move the tool to a safe position

- ▶ Repeat the procedure for the second recess

- ▶ Switch off the spindle

- ▶ You have successfully machined the recesses.



5.7 Finishing the outside contour

In the fourth and final machining step, you will machine the outside contour using the finishing tool.

i Prior to finishing, you should first machine the chamfer (1 x 45°) and lightly chamfer all of the other edges so as to prevent the formation of burrs.

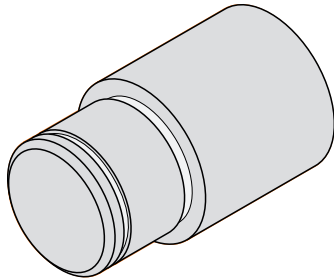

Figure 21: Example workpiece – finishing the outside contour



- ▶ Insert the finishing tool into the tool holder
- ▶ Tap **Tools** on the status bar
- ▶ The **Tools** dialog box appears.
- ▶ Tap **Finishing tool**
- ▶ Tap **Confirm**
- ▶ The associated tool parameters are applied automatically.
- ▶ The **Tools** dialog is closed.
- ▶ Set a spindle speed of 1500 rpm
- ▶ Position the tool:
 - X: 25.0 mm
 - Z: 16.0 mm
- ▶ Perform face turning with the finishing tool
- ▶ Move the tool to a safe position
- ▶ Position the tool:
 - X: 19.8 mm
 - Z: 17.0 mm
- ▶ Position the tool:
 - Z: 12.5 mm
- ▶ Position the tool:
 - X: 20.015 mm
- ▶ Position the tool:
 - Z: 1.5 mm
- ▶ Position the tool:
 - X: 19.5 mm
- ▶ Position the tool:
 - Z: 0.0 mm
- ▶ Position the tool:
 - X: 25.0 mm
- ▶ Move the tool to a safe position
- ▶ Spindle OFF
- ▶ You have successfully finished the outside contour.

6

ScreenshotClient

6.1 Overview

The standard installation of ND 7000 Demo also contains the ScreenshotClient program. With ScreenshotClient, you can take screenshots of the demo software or the unit.

This chapter describes how ScreenshotClient is configured and used.

6.2 Information about ScreenshotClient

With ScreenshotClient, you can take screenshots of the active screen of the demo software or the unit from a computer. Before taking a screenshot, select the desired user interface language, as well as the file name and the location where you want to store the screenshots.

ScreenshotClient creates image files of the desired screen:

- In .PNG format
- With the configured name
- With the appropriate language code
- With the time information of year, month, day, hour, minute, and second

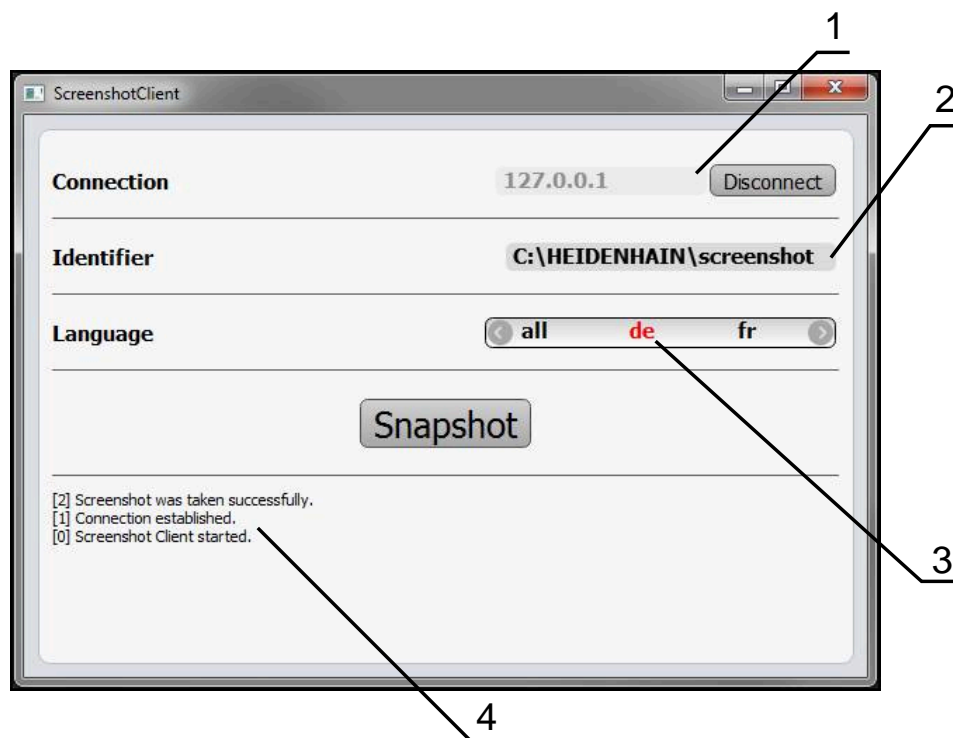

Figure 22: ScreenshotClient user interface

- 1 Connection status
- 2 File path and file name
- 3 Language selection
- 4 Status messages

6.3 Starting ScreenshotClient

- ▶ Select in succession in Microsoft Windows:
 - **Start**
 - **All programs**
 - **HEIDENHAIN**
 - **ND 7000 Demo**
 - **ScreenshotClient**
- > ScreenshotClient is started:

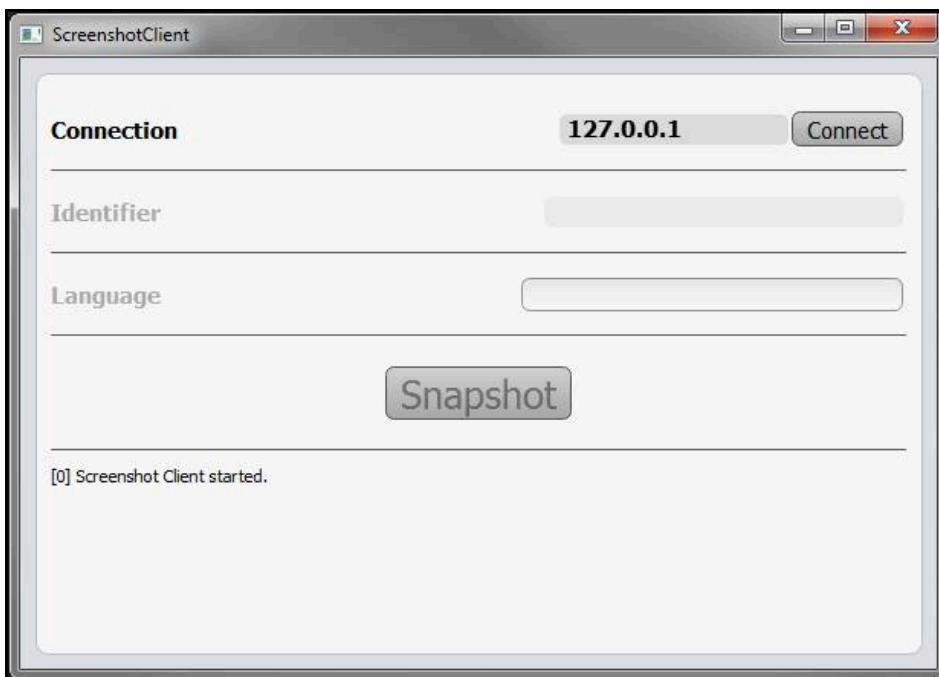

Figure 23: ScreenshotClient has been started (not connected yet)

- > You can now connect ScreenshotClient with the demo software or with the unit.

6.4 Connecting ScreenshotClient with the demo software

i Before establishing a connection with ScreenshotClient, first start the demo software or switch on the unit. Otherwise ScreenshotClient will show the status message **Connection close.** when trying to connect.

- ▶ Start the demo software if you have not already done so
Further information: "Starting ND 7000 Demo", Page 22
- ▶ Tap **Connect**
- > A connection with the demo software is established.
- > The status message is updated.
- > The **Identifier** and **Language** input fields become active.

6.5 Connecting ScreenshotClient with the unit

Requirement: The network must be configured on the device.



For detailed information on configuring the network at the unit, please refer to the "Setup" chapter in the operating instructions of ND 7000.



Before establishing a connection with ScreenshotClient, first start the demo software or switch on the unit. Otherwise ScreenshotClient will show the status message **Connection close**. when trying to connect.

- ▶ Switch on the unit if you have not already done so
- ▶ Enter the **IPv4 address** of the interface in the **Connection** input field. You will find the address in the device settings under:
Interfaces ▶ Network ▶ X116
- ▶ Tap **Connect**
- > A connection with the unit is established.
- > The status message is updated.
- > The **Identifier** and **Language** input fields become active.

6.6 Configuring ScreenshotClient for taking screenshots

Once you have started ScreenshotClient, you can make the following configurations:

- Location at which screenshots are stored, and what the file names are
- User interface language in which the screenshots are created

6.6.1 Configuring the storage location and file name for screenshots

By default, ScreenshotClient saves screenshots to the following storage location:

C: ▶ HEIDENHAIN ▶ [product designation] ▶ ProductsMGE5 ▶ Mom ▶ [product code] ▶ sources ▶ [file name]

You can define a different storage location, if necessary.

- ▶ Tap the **Identifier** input field
- ▶ Enter the path to the storage location and the name for the screenshots into the **Identifier** input field



Use the following syntax to enter the path and file name for screenshots:

[drive]:\[folder]\[file name]

- > ScreenshotClient will save all screenshots to the storage location entered.

6.6.2 Configuring the user interface language of screenshots

The **Language** input field shows all of the user interface languages available for the demo software or the unit. Once you have selected a language code, ScreenshotClient will take screenshots in the corresponding language.



The user interface language you are using in the demo software or on the unit does not have any effect on the screenshots. Screenshots are always created in the language that you have selected in ScreenshotClient.

Screenshots in the desired user interface language

To take screenshots in a desired user interface language



- ▶ Use the arrow keys to select the desired language code in the **Language** input field
- > The selected language code is shown in red.
- > ScreenshotClient creates the screenshots in the desired user interface language.

Screenshots of all available user interface languages

To create screenshots in all available user interface languages



- ▶ Use the arrow keys to select **all** in the **Language** input field
- > The **all** language code is shown in red.
- > ScreenshotClient creates the screenshots in all available user interface languages.

6.7 Creating screenshots

- ▶ In the demo software or on the unit, call the view from which you would like to take a screenshot
- ▶ Switch to **ScreenshotClient**
- ▶ Tap **Snapshot**
- > The screenshot is created and saved to the configured storage location.

 The screenshot is saved in the format [file name]_[language code]_[YYYYMMDDhhmmss] (e.g., **screenshot_en_20170125114100**)

- > The status message is updated:



Figure 24: ScreenshotClient after screenshot has been created successfully

6.8 Exiting ScreenshotClient

- ▶ Tap **Disconnect**
- > The connection to the demo software or the unit is terminated.
- ▶ Tap **Close**
- > ScreenshotClient is exited.

7 Index

A			
Application			
Selecting.....	46		
C			
Configuration data			
Copying the file.....	46		
Uploading the file.....	47		
Configuring			
File name for screenshots.....	64		
ScreenshotClient.....	64		
Software.....	44		
Storage location for screenshots.			
64			
User interface language of			
screenshots.....	64		
Coupling axes.....	54		
D			
Demo software			
Features.....	8		
Intended use.....	8		
Documentation			
Notes on reading.....	8		
Dragging.....	19		
E			
Example			
Bearing seat drawing			
stud bolt.....	51		
Finishing the outside contour..	60		
preset.....	57		
Roughing the outside contour.	58		
Setting up the lathe.....	54		
Turning recesses.....	59		
Workpiece.....	50		
Exiting			
ScreenshotClient.....	66		
F			
File management			
Menu.....	33		
G			
Gestures			
Dragging.....	19		
Holding.....	19		
Operation.....	18		
Tapping.....	18		
H			
Holding.....	19		
I			
Input devices			
Operation.....	18		
Installation file			
Downloading.....	12		
L			
Language			
setting.....	24, 44		
Lathe			
Tool measurement.....	55		
M			
Main menu.....	25		
Manual operation.....	27		
menu.....	27		
MDI			
menu.....	28		
Menu			
File management.....	33		
manual operation.....	27		
MDI.....	28		
Programming.....	31		
Settings.....	35		
Switch-off.....	36		
User login.....	34		
Mouse actions			
Dragging.....	19		
Holding.....	19		
Operation.....	18		
Tapping.....	18		
O			
OEM bar.....	42		
Operating elements.....	42		
Operating elements			
Add.....	21		
Back.....	21		
Close.....	21		
Confirm.....	21		
Drop-down list.....	21		
Main menu.....	25		
OEM bar.....	42		
Plusminus button.....	20		
Screen keyboard.....	20		
Slide switch.....	20		
status bar.....	41		
Toggle switch.....	20		
Undo.....	21		
Operation			
General operation.....	18		
Gestures and mouse actions...	18		
Operating elements.....	20		
Touchscreen and input			
devices.....	18		
P			
Password.....	24		
Default settings.....	50		
Preset			
Probing.....	42		
Product version.....	45		
Programming			
Menu.....	31		
Program run			
Menu.....	30		
Q			
Quick start.....	50		
S			
ScreenshotClient.....	62		
Configuring.....	64		
Connecting.....	63		
Creating screenshots.....	65		
Exiting.....	66		
Information.....	62		
Starting.....	63		
Screenshots			
Configuring the file name.....	64		
Configuring the storage			
location.....	64		
Configuring the user interface			
language.....	64		
Creating.....	65		
Settings			
Menu.....	35		
Shut-down			
Software.....	23		
Software			
Configuration data.....	46, 47		
Downloading the installation			
file.....	12		
Enabling functions.....	44		
installation.....	13		
Shut-down.....	23		
Starting.....	22		
System requirements.....	12		
Uninstallation.....	15		
Software options			
Activating.....	44		
Starting			
ScreenshotClient.....	63		
Software.....	22		
Status bar.....	40		
operating elements.....	41		
Switch-off			
Menu.....	36		
Symbols and fonts used for			
marking text.....	9		
T			
Tapping.....	18		
Tool table			
Creating.....	53		
Touchscreen			
Operation.....	18		
Turning the recess.....	59		

U

Use

Improper..... 8

Intended..... 8

User

Default password..... 24

Login..... 24

Logout..... 24

User login..... 24

User interface

After start-up..... 25

File management menu..... 33

Main menu..... 25

manual operation menu..... 27

MDI menu..... 28

Programming menu..... 31

Program run menu..... 30

Settings menu..... 35

Switch-off menu..... 36

User login menu..... 34

User login..... 24, 34

8 List of figures

Image 1:	Installation wizard	13
Image 2:	Installation wizard with activated options Demo software and Screenshot Utility	14
Image 3:	User login menu.....	22
Image 4:	Manual operation menu.....	27
Image 5:	MDI menu.....	28
Image 6:	MDI block dialog box.....	29
Image 7:	Program run menu.....	30
Image 8:	Programming menu.....	31
Image 9:	Programming menu with opened simulation window.....	32
Image 10:	File management menu.....	33
Image 11:	User login menu.....	34
Image 12:	Settings menu.....	35
Image 13:	Settings menu.....	47
Image 14:	Example workpiece.....	50
Image 15:	Example workpiece – technical drawing.....	51
Image 16:	Finishing tool parameters.....	54
Image 17:	Preset.....	54
Image 18:	Example workpiece – finding the preset.....	57
Image 19:	Example workpiece – roughing the outside contour.....	58
Image 20:	Example workpiece – turning recesses.....	59
Image 21:	Example workpiece – finishing the outside contour.....	60
Image 22:	ScreenshotClient user interface.....	62
Image 23:	ScreenshotClient has been started (not connected yet).....	63
Image 24:	ScreenshotClient after screenshot has been created successfully.....	65

HEIDENHAIN

DR. JOHANNES HEIDENHAIN GmbH

Dr.-Johannes-Heidenhain-Straße 5

83301 Traunreut, Germany

☎ +49 8669 31-0

☎ +49 8669 32-5061

info@heidenhain.de

Technical support ☎ +49 8669 32-1000

Measuring systems ☎ +49 8669 31-3104

service.ms-support@heidenhain.de

NC support ☎ +49 8669 31-3101

service.nc-support@heidenhain.de

NC programming ☎ +49 8669 31-3103

service.nc-pgm@heidenhain.de

PLC programming ☎ +49 8669 31-3102

service.plc@heidenhain.de

APP programming ☎ +49 8669 31-3106

service.app@heidenhain.de

www.heidenhain.com

