



1382631-20

Operating Instructions (Authorized Documentation)

LC 415

14A

Functional Safety

English (en)
05/2026

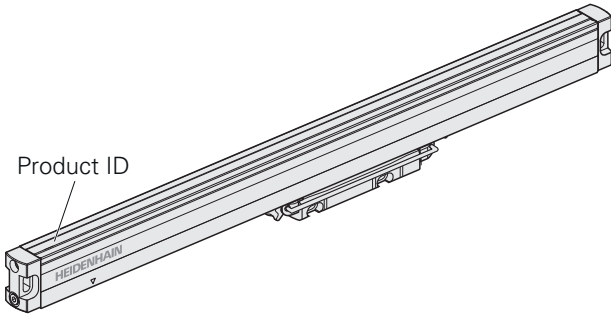

Image without details



Find freely available documents for your product at:
www.heidenhain.com/documentation

Product ID

Search



EN	DE	FR	IT	ES	SV	NL	DA	FI	CS	BG
ET	EL	HU	JA	KO	LV	TR	NO	PL	PT	RU
			SL	RO	SK	LT	HR	zh-CN	zh-TW	

This document is provided in multiple languages:

1382631

Search

1 Fundamentals

1.1 About these instructions

These Instructions contain all the information and safety precautions needed for the proper operation of the product according to its intended use.



Further information is available in specific documents, depending on the life-cycle phase of the product and on the target group for the activity.

Further information: "Information based on the document type, the life-cycle phase of the product, and the target group", Page 2

1.2 Notes on reading this document

⚠ WARNING

Fatal accidents, personal injury or property damage caused by non-compliance with the documentation!

Failure to comply with the documentation may result in fatal accidents, personal injury or property damage.

- ▶ Read the documentation carefully from beginning to end
- ▶ Keep the documentation for future reference

2 Safety

2.1 Intended use

The products of this/these series are encoders for position measurement.

The products are intended for use in research facilities, commercial applications, and in an industrial environment.

The products must be used only in accordance with the information based on the life-cycle phase of the product and on the target group.

Further information: "Information based on the document type, the life-cycle phase of the product, and the target group", Page 2

2.2 Improper use

Any use not specified in "Intended use" is considered improper use. The company operating the device is solely liable for any damage resulting from improper use.

2.3 Obligations of the operating company

The company operating the product must provide the personnel with the most current version of all documentation on the product.

2.4 General safety precautions



Mounting and initial configuration must be conducted by a qualified specialist in compliance with local safety regulations.



Encoders and encoder accessories may only be repaired by trained HEIDENHAIN technicians.

⚠ WARNING

Fatal accidents, personal injury, or property damage when engaging or disengaging live connecting elements!

Engaging or disengaging connecting elements while the system is under power may result in fatal accidents, personal injury, or property damage.

- ▶ Do not engage or disengage any connecting elements while the product is under power.



Encoders and encoder accessories that have contributed to the failure of a safety function in the application must be returned to HEIDENHAIN Traunreut.

3 Declaration of Conformity



The encoder complies with the requirements of the following directives:

EU: 2006/42/EC (valid until 2027-01-19),
(EU) 2023/1230 (valid as of 2027-01-20);
2014/30/EU; 2011/65/EU









4 Information based on the document type, the life-cycle phase of the product, and the target group

 The following documents must be read and observed by the stated target groups before mounting, initial configuration, or disposal of the encoder.

 Freely available documents are available at  www.heidenhain.com/documentation.
Further documents are available upon  **Request**.

 Installation technician,  Designer,  Control manufacturer

Document	Document ID	Life-cycle phase of the product/Contents			
Operating Instructions Operating Instructions LC 415 14A Functional Safety	1382631	<ul style="list-style-type: none"> ■ Operation of the unit 	✓	✓	✓
Montageanleitung Mounting Instructions LC 415, LC 495S End Block 14A FS	737907	<ul style="list-style-type: none"> ■ Mounting the product 	✓	✓	
Mounting Instructions Mounting Instructions MSL 41	894918	<ul style="list-style-type: none"> ■ Mounting the product using the MSL 41 mounting spar 	✓	✓	
Brochure Interfaces of HEIDENHAIN Encoders	1078628	<ul style="list-style-type: none"> ■ Interfaces and measuring methods ■ Electrical connection ■ Interface electronics 		✓	✓
Brochure Linear Encoders for Numerically Controlled Machine Tools	571470	<ul style="list-style-type: none"> ■ Technical features, operating conditions, and mounting information ■ Specifications, mating dimensions ■ Electrical connection ■ Accessory 		✓	✓
Brochure Cables and Connectors	1206103	<ul style="list-style-type: none"> ■ Cables and connectors for signal transmission between the position measuring system and the subsequent electronics 	✓	✓	✓
Technical Information Safety-Related Position Measuring Systems	596632	<ul style="list-style-type: none"> ■ General description of the Safety concept 		✓	✓
Specification Specification for Safe Control	533095  Request	<ul style="list-style-type: none"> ■ Implementation requirements for EnDat2.2 Safe 			✓
Specification CAD	 Website Search for product ID	<ul style="list-style-type: none"> ■ Views ■ Dimensions 	✓	✓	
Declaration of Conformity	 Website Search for product ID	<ul style="list-style-type: none"> ■ Conformity with applicable directives 		✓	✓

Technical support

Measuring systems  +49 8669 31-3104
E-mail: service.ms-support@heidenhain.de
www.heidenhain.com

HEIDENHAIN

DR. JOHANNES HEIDENHAIN GmbH
Dr.-Johannes-Heidenhain-Straße 5
D-83301 Traunreut, Germany