



GAGE-CHEK 2000

Operating Instructions

Evaluation Unit

Notes on the structure of this document

This document consists of three main parts:

Part	Chapter
I	General Information
This part of the documentation provides general information for all persons who come into contact with the product.	<ul style="list-style-type: none"> ■ "Fundamentals", Page 7 ■ "Safety", Page 14 ■ "Basic Operation", Page 19
II	Information for OEM and Setup Users
This part of the documentation provides information on the installation, commissioning and setup of the product.	<ul style="list-style-type: none"> ■ "Transport and Storage", Page 50 ■ "Mounting", Page 56 ■ "Installation", Page 62 ■ "Commissioning", Page 74 ■ "Setup", Page 122 ■ "File Management", Page 151 ■ "Settings", Page 158 ■ "Servicing and Maintenance", Page 173 ■ "Removal and Disposal", Page 185 ■ "Specifications", Page 187
III	Information for the Operator
This part of the documentation provides information on the operation of the device. It serves for daily reference when working with the device.	<ul style="list-style-type: none"> ■ "Preparing a measurement", Page 200 ■ "Preset", Page 202 ■ "Configuring function elements and conducting a measurement", Page 207 ■ "Sending measured values to a computer", Page 242 ■ "What to do if ...", Page 248
Appendix	<ul style="list-style-type: none"> ■ "Index", Page 253 ■ "List of figures", Page 256



General Information

Overview

This part of the documentation contains general information for the OEM, Setup and Operator users.

Contents of chapters in the "General information" part

The table below shows:

- The chapters included in this "General information" part
- The information contained in these chapters
- The target groups that these chapters are mainly intended for

Chapter	Contents	Target group		
		OEM	Setup	Operator
This chapter contains information about...				
1 "Fundamentals"	... this product ... these instructions	✓	✓	✓
2 "Safety"	... safety regulations and safety measures <ul style="list-style-type: none"> ■ for mounting the product ■ for installing the product ■ for operating the product 	✓	✓	✓
3 "Basic Operation"	... the operating elements of the product user interface ... the user interface of the product ... basic functions of the product	✓	✓	✓

Table of contents

1	Fundamentals.....	7
1.1	Overview.....	8
1.2	Information on the product.....	8
1.3	Overview of new and modified functions.....	8
1.4	Demo software for the product.....	8
1.5	Documentation on the product.....	9
1.5.1	Validity of the documentation.....	9
1.5.2	Notes on reading the documentation.....	10
1.5.3	Storage and distribution of the documentation.....	11
1.6	About these instructions.....	11
1.6.1	Document category.....	11
1.6.2	Target groups for the instructions.....	11
1.6.3	Target groups according to user types.....	12
1.6.4	Notes in this documentation.....	12
1.6.5	Symbols and fonts used for marking text.....	13
2	Safety.....	14
2.1	Overview.....	15
2.2	General safety precautions.....	15
2.3	Intended use.....	15
2.4	Improper use.....	15
2.5	Personnel qualification.....	16
2.6	Obligations of the operating company.....	16
2.7	General safety precautions.....	17
2.7.1	Symbols on the product.....	17
2.7.2	Electrical safety precautions.....	18
3	Basic Operation.....	19
3.1	Overview.....	20
3.2	Using the touchscreen and input devices.....	20
3.2.1	Touchscreen and input devices.....	20
3.2.2	Gestures and mouse actions.....	20
3.3	General operating elements and functions.....	22
3.4	GAGE-CHEK 2000 – switch-on and switch-off.....	24
3.4.1	Switching on the GAGE-CHEK 2000.....	24
3.4.2	Activating and deactivating the energy saving mode.....	24
3.4.3	Switching off the GAGE-CHEK 2000.....	25
3.5	User login and logout.....	25
3.5.1	User login.....	26
3.5.2	User logout.....	26
3.6	Setting the language.....	27
3.7	Performing the reference mark search after startup.....	27
3.8	User interface.....	28
3.8.1	User interface after switch-on.....	28
3.8.2	Main menu of the user interface.....	29
3.8.3	Measure menu.....	30
3.8.4	File management menu.....	31
3.8.5	User login menu.....	32
3.8.6	Settings menu.....	33

3.8.7	Switch-off menu.....	34
3.9	Position display.....	34
3.9.1	Operating elements of the position display.....	34
3.10	Customizing the workspace.....	35
3.10.1	Hiding and showing the main menu.....	35
3.10.2	Hiding or displaying the function bar.....	35
3.10.3	Scrolling the function bar.....	35
3.10.4	Moving functions on the function bar.....	35
3.11	Using the function bar.....	36
3.11.1	Operating elements of the function bar.....	36
3.11.2	Function elements.....	36
3.11.3	Adjusting settings in the quick access menu.....	40
3.12	Messages and audio feedback.....	41
3.12.1	Messages.....	41
3.12.2	Wizard.....	42
3.12.3	Audio feedback.....	43

1

Fundamentals

1.1 Overview

This chapter contains information about the product and this manual.

1.2 Information on the product

Product designation	ID	Firmware version	Index
GAGE-CHEK 2000	1089181-xx, 1089182-xx	1248580.1.6.x	---

The ID label is provided on the rear panel of the product.

Example:



- 1 Product designation
- 2 Index
- 3 Part number (ID)

1.3 Overview of new and modified functions

This document provides a short overview of new and modified functions or settings becoming available with version 1248580.1.6.x.

Formula function

The new Formula function performs calculations with position values. Numerous arithmetic operations are possible. For example, you can calculate the mean value, circumference and many other values.

Further information: "Formula", Page 232

Parallel Measured value output

In the new version, the restriction prohibiting the simultaneous use of manually triggered or touch-probe triggered measured value output and continuous measured value output has been removed.

Further information: "Sending measured values to a computer", Page 242

1.4 Demo software for the product

GAGE-CHEK 2000 Demo is software you can install on a computer regardless of the device. GAGE-CHEK 2000 Demo helps you to become familiar with, try out or present the functions of the device.

You can download the current version of the software here:

<https://portal.heidenhain.de>



To download the installation file from the HEIDENHAIN Portal, you need access rights to the **Software** portal folder in the directory of the appropriate product.

If you do not have access rights to the Portal's **Software** folder, you can request the access rights from your HEIDENHAIN contact person.

1.5 Documentation on the product

1.5.1 Validity of the documentation

Before using the documentation and the product, you need to verify that the documentation matches the product.

- ▶ Compare the ID number and the index indicated in the documentation with the corresponding data given on the ID label of the product
- ▶ Compare the firmware version given in the documentation with the firmware version of the product

Further information: "Device information", Page 160

- > If the part numbers and indexes as well as the firmware versions match, the documentation is valid.



If the ID numbers and indexes do not match so that the documentation is not valid, you will find the current documentation at www.heidenhain.com.

1.5.2 Notes on reading the documentation

 WARNING
<p>Fatal accidents, personal injury or property damage caused by non-compliance with the documentation!</p> <p>Failure to comply with the documentation may result in fatal accidents, personal injury or property damage.</p> <ul style="list-style-type: none"> ▶ Read the documentation carefully from beginning to end ▶ Keep the documentation for future reference

The table below lists the components of the documentation in the order of priority for reading.

Documentation	Description
Addendum	An Addendum supplements or supersedes the corresponding contents of the Operating Instructions and, if applicable, of the Installation Instructions. If an Addendum is included in the shipment, it has the highest priority for reading. All other contents of the documentation retain their validity.
Installation Instructions	The Installation Instructions contain all of the information and safety precautions needed for the proper mounting and installation of the product. The Installation Instructions are contained as an excerpt from the Operating Instructions in every delivery. The Installation Instructions have the second highest level of priority for reading.
Operating Instructions	The Operating Instructions contain all the information and safety precautions needed for the proper operation of the product according to its intended use. The Operating Instructions are included on the supplied storage medium and can also be downloaded in the download area from www.heidenhain.com . The Operating Instructions must be read before the unit is put into service. The Operating Instructions have the third highest level of priority for reading.

Have you found any errors or would you like to suggest changes?

We are continuously striving to improve our documentation for you. Please help us by sending your suggestions to the following e-mail address:

userdoc@heidenhain.de

1.5.3 Storage and distribution of the documentation

The instructions must be kept in the immediate vicinity of the workplace and must be available to all personnel at all times. The operating company must inform the personnel where these instructions are kept. If the instructions have become illegible, the operating company must obtain a new copy from the manufacturer.

If the product is given or resold to any other party, the following documents must be passed on to the new owner:

- Addendum (if supplied)
- Installation Instructions
- Operating Instructions

1.6 About these instructions

These instructions provide all the information and safety precautions needed for the safe operation of the device.

1.6.1 Document category

Operating Instructions

These instructions are the **Operating Instructions** for the product.

The Operating Instructions

- Is oriented to the product life cycle
- Contains all information and safety precautions needed for the proper operation of the product according to its intended use

1.6.2 Target groups for the instructions

These instructions must be read and observed by every person who performs any of the following tasks:

- Mounting
- Installation
- Commissioning and configuration
- Operation
- Service, cleaning and maintenance
- Troubleshooting
- Removal and disposal

1.6.3 Target groups according to user types

The target groups of these instructions refer to the various user types of the product and their authorizations.

The product features the following user types:

OEM user

The **OEM** (Original Equipment Manufacturer) user has the highest level of permissions. This user is allowed to configure the product's hardware (e.g. connection of encoders and sensors). He can create **Setup** and **Operator**-type users, and configure the **Setup** and **Operator** users. The **OEM** user cannot be duplicated or deleted. This user cannot be logged in automatically.

Setup user

The **Setup** user configures the product for use at the place of operation. This user can create **Operator**-type users. The **Setup** user cannot be duplicated or deleted. This user cannot be logged in automatically.

Operator user

The **Operator** user is permitted to use the basic functions of the product. An **Operator**-type user cannot create additional users, but is allowed to edit various operator-specific settings, such as his name or the language. A user of the **Operator** group can be logged in automatically as soon as the product is switched on.

1.6.4 Notes in this documentation

Safety precautions

Precautionary statements warn of hazards in handling the product and provide information on their prevention. Precautionary statements are classified by hazard severity and divided into the following groups:

⚠ DANGER
Danger indicates hazards for persons. If you do not follow the avoidance instructions, the hazard will result in death or severe injury .
⚠ WARNING
Warning indicates hazards for persons. If you do not follow the avoidance instructions, the hazard could result in death or serious injury .
⚠ CAUTION
Caution indicates hazards for persons. If you do not follow the avoidance instructions, the hazard could result in minor or moderate injury .
NOTICE
Notice indicates danger to material or data. If you do not follow the avoidance instructions, the hazard could result in property damage .



Informational notes

Informational notes ensure reliable and efficient operation of the product. Informational notes are divided into the following groups:

 The information symbol indicates a **tip**.
A tip provides important additional or supplementary information.

 The gear symbol indicates a function that **depends on the machine**.
The function described depends on the machine if, for example:

- A certain software or hardware option is required on your machine
- The behavior of the functions depends on the configurable machine settings

 The book symbol indicates a **cross reference**.
A cross reference leads to external documentation for example the documentation of your machine manufacturer or other supplier.

1.6.5 Symbols and fonts used for marking text

In these instructions the following symbols and fonts are used for marking text:

Depiction	Meaning
▶ ...	Identifies an action and the result of this action
> ...	Example: ▶ Tap OK > The message is closed
■ ...	Identifies an item of a list
■ ...	Example: ■ TTL interface ■ EnDat interface ■ ...
Bold	Identifies menus, displays and buttons Example: ▶ Tap Shut down > The operating system shuts down. ▶ Turn the power switch off

2

Safety

2.1 Overview

This chapter provides important safety information needed for the proper operation of the unit.

2.2 General safety precautions

General accepted safety precautions, in particular the applicable precautions relating to the handling of live electrical equipment, must be followed when operating the system. Failure to observe these safety precautions may result in personal injury or damage to the product.

It is understood that safety rules within individual companies vary. If a conflict exists between the material contained in these instructions and the rules of a company using this system, the more stringent rules take precedence.

2.3 Intended use

The products of the GAGE-CHEK 2000 series are advanced digital evaluation electronics for the measurement of exact measured values and for positioning tasks in metrology applications. The products are used primarily on measuring machines and positioning equipment.

The products of this series

- must only be used in commercial applications and in an industrial environment
- must be mounted on a suitable stand or holder to ensure the correct and intended operation of the product
- are intended for indoor use in an environment in which the contamination caused by humidity, dirt, oil and lubricants complies with the requirements of the specifications



The products support the use of peripheral devices from different manufacturers. HEIDENHAIN cannot make any statements on the intended use of these devices. The information on their intended use, which is provided in the respective documentation, must be observed.

2.4 Improper use

In particular, the products of the GAGE-CHEK 2000 series must not be used in the following applications:

- Use and storage outside the operating conditions specified in "Specifications"
- Outdoor use
- Use in potentially explosive atmospheres
- Use of the products of the GAGE-CHEK 2000 series as part of a safety function

2.5 Personnel qualification

The personnel for mounting, installation, operation, service, maintenance and removal must be appropriately qualified for this work and must have obtained sufficient information from the documentation supplied with the product and with the connected peripherals.

The personnel required for the individual activities to be performed on the product are indicated in the respective sections of these instructions.

The personnel groups are specified in detail as follows with regard to their qualifications and tasks.

Operator

The operator uses and operates the product within the framework specified for the intended use. He is informed by the operating company about the special tasks and the potential hazards resulting from incorrect behavior.

Qualified personnel

The qualified personnel are trained by the operating company to perform advanced operation and parameterization. The qualified personnel have the required technical training, knowledge and experience and know the applicable regulations, and are thus capable of performing the assigned work regarding the application concerned and of proactively identifying and avoiding potential risks.

Electrical specialist

The electrical specialist has the required technical training, knowledge and experience and knows the applicable standards and regulations, and is thus capable of performing work on electrical systems and of proactively identifying and avoiding potential risks. Electrical specialists have been specially trained for the environment they work in.

Electrical specialists must comply with the provisions of the applicable legal regulations on accident prevention.

2.6 Obligations of the operating company

The operating company owns or leases the device and the peripherals. At all times, the operating company is responsible for ensuring that the intended use is complied with.

The operating company must:

- Assign the different tasks to be performed on the device to suitable, qualified and authorized personnel
- Verifiably train the personnel in the authorizations and tasks
- Provide all materials and means necessary in order for the personnel to complete the assigned tasks
- Ensure that the device is operated only when in perfect technical condition
- Ensure that the device is protected from unauthorized use



2.7 General safety precautions



 The safety of any system incorporating the use of this product is the responsibility of the assembler or installer of the system.

 The product supports the use of a wide variety of peripheral devices from different manufacturers. HEIDENHAIN cannot make any statements on the specific safety precautions to be taken for these devices. The safety precautions provided in the respective documentation must be observed. If there is no documentation at hand, it must be obtained from the manufacturers concerned.

The specific safety precautions required for the individual activities to be performed on the product are indicated in the respective sections of these instructions.

2.7.1 Symbols on the product

The following symbols are used to identify the product:

Symbol	Meaning
	Observe the safety precautions regarding electricity and the power connection before you connect the product.
	Functional ground connection as per IEC/EN 60204-1. Observe the information on installation.
	Product seal. Breaking or removing the product seal will result in forfeiture of warranty and guarantee.

2.7.2 Electrical safety precautions

WARNING

Hazard of contact with live parts when opening the product.

This may result in electric shock, burns or death.

- ▶ Never open the housing
- ▶ Only the manufacturer is permitted to access the inside of the product

WARNING

Hazard of dangerous amount of electricity passing through the human body upon direct or indirect contact with live electrical parts.

This may result in electric shock, burns or death.

- ▶ Work on the electrical system and live electrical components is to be performed only by trained specialists
- ▶ For power connection and all interface connections, use only cables and connectors that comply with applicable standards
- ▶ Have the manufacturer exchange defective electrical components immediately
- ▶ Regularly inspect all connected cables and all connections on the product. Defects, such as loose connections or scorched cables, must be removed immediately

NOTICE

Damage to internal parts of the product!

If you open the product, the warranty and the guarantee will become void.

- ▶ Never open the housing
- ▶ Only the product manufacturer is permitted to access the inside of the product

3

Basic Operation

3.1 Overview

This chapter describes the user interface, operating elements, and basic functions of the product.

3.2 Using the touchscreen and input devices

3.2.1 Touchscreen and input devices

The operating elements on the user interface of the unit are operated via a touchscreen or a connected USB mouse.

To enter data, you can use the screen keyboard of the touchscreen or a connected USB keyboard.

NOTICE

Malfunctions of the touchscreen caused by humidity or contact with water!

Humidity or water can impair the proper functioning of the touchscreen.

- ▶ Protect the touchscreen from humidity or contact with water

Further information: "Product data", Page 188

3.2.2 Gestures and mouse actions

To activate, switch or move the operating elements of the user interface, you can use the unit's touchscreen or a mouse. Gestures are used to operate the touchscreen and the mouse.

i The gestures for operating the touchscreen may differ from the gestures for operating the mouse.

If the gestures for operating the touchscreen differ from those for operating the mouse, then these instructions describe both operating options as alternative actions.

The alternative actions for operating the touchscreen or the mouse are identified by the following symbols:



Operation using the touchscreen



Operation using the mouse

The following overview describes the different gestures for operating the touchscreen or the mouse:

Tapping



Means touching the screen briefly with your fingertip



Means pressing the left mouse button once



The actions initiated by tapping include

- Selection of menus, features, or parameters
- Entering characters with the screen keyboard
- Closing dialogs
- Displaying and hiding the main menu in the **Measure** menu
- Displaying and hiding the function bar in the **Measure** menu

Holding (long press)



Means touching the screen and holding your finger(s) on it for a few seconds



Means pressing the left mouse button once and holding it down

The actions initiated by holding are

- Quickly changing the values in input fields with plus and minus buttons
- Activate multiple selection

Dragging



Is a combination of long press and then swipe, moving a finger over the touchscreen when at least the starting point of motion is defined



Means pressing the left mouse button once and holding it down while moving the mouse; at least the starting point of the motion is defined

The actions initiated by dragging include



- Scrolling through lists and texts

Swiping



A flowing movement of a finger across the touchscreen without a defined starting and end point



Single pressing and holding down of the left mouse button while simultaneously moving the mouse; the starting point and end point of the movement are not clearly defined

The actions initiated by swiping include



- Switching the views

3.3 General operating elements and functions

The operating elements described below are available for configuration and operating the product via the touchscreen or input devices.

Screen keyboard

The screen keyboard enables you to enter text into the input fields of the user interface. Depending on the input field, a numeric or alphanumeric screen keyboard is shown.

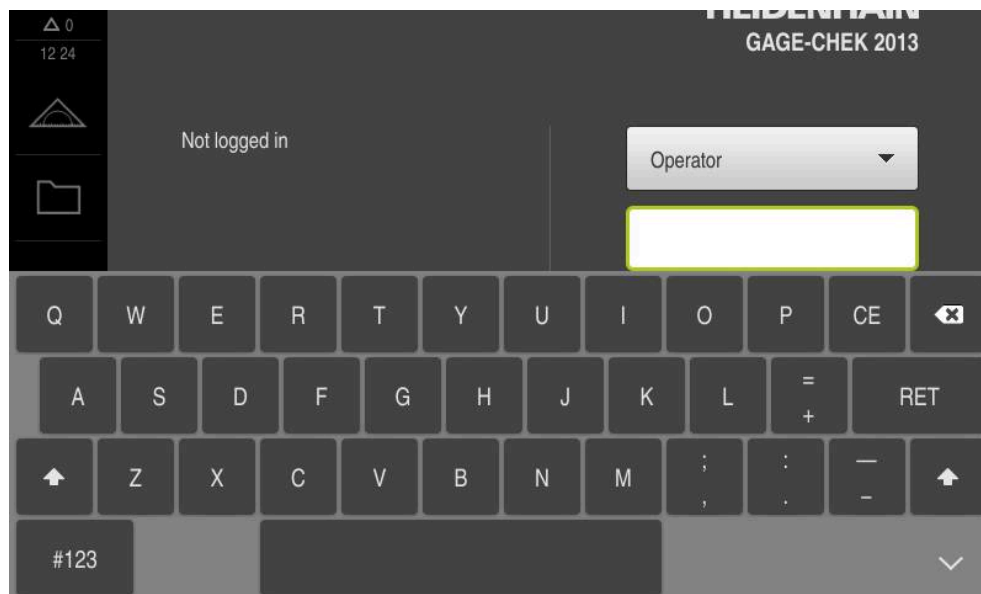



Figure 1: Screen keyboard











Screen keyboard

- ▶ To enter values, tap an input field
- > The input field is highlighted.
- > The screen keyboard is displayed.
- ▶ Enter text or numbers
- > If the entry is correct and complete, a green check mark is displayed, as applicable.
- > If the entry is incomplete or the values are incorrect, a red exclamation mark is displayed, as applicable. In this case, the entry cannot be completed.
- ▶ To apply the values, confirm the entry with **RET**
- > The values are displayed
- > The screen keyboard disappears.

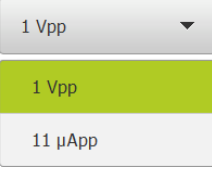
Operating elements

Operating element	Function
	<p>Input fields with plus and minus buttons</p> <p>To adjust a numerical value, use the + (plus) and - (minus) buttons to the left and right of the numerical value.</p> <ul style="list-style-type: none"> ▶ Tap + or - until the desired value is displayed ▶ Long-press + or - to scroll through the values more quickly > The selected value is displayed.



Operating element	Function
	<p>Toggle switch</p> <p>Use the toggle switch to switch between functions.</p> <ul style="list-style-type: none"> ▶ Tap the desired function > The active function is shown in green. > The inactive function is shown in light gray.
 	<p>Slide switch</p> <p>Use the slide switch to activate or deactivate a function.</p> <ul style="list-style-type: none"> ▶ Drag the slider to the desired position or ▶ Tap the slide switch > The function is activated or deactivated.
	<p>Slider</p> <p>Use the slider (horizontal or vertical) to continuously adjust values.</p> <ul style="list-style-type: none"> ▶ Drag the slider to the desired position > The selected value is displayed graphically or in percent.
	<p>Drop-down list</p> <p>Buttons that open drop-down lists are indicated by a triangle pointing down.</p> <ul style="list-style-type: none"> ▶ Tap the button > The drop-down list opens. > The active entry is highlighted in green. ▶ Tap the desired entry > The selected entry is applied.
Operating element	Function
	<p>Undo</p> <p>This button allows you to undo the last action.</p> <p>Processes that have already been concluded cannot be undone.</p> <ul style="list-style-type: none"> ▶ Tap Undo > The last action is undone
	<p>Add</p> <ul style="list-style-type: none"> ▶ Tap Add to add a feature > The new feature is added
	<p>Close</p> <ul style="list-style-type: none"> ▶ Tap Close to close a dialog
	<p>Confirm</p> <ul style="list-style-type: none"> ▶ Tap Confirm to conclude an action
	<p>Back</p> <ul style="list-style-type: none"> ▶ Tap Back to return to the higher level in the menu structure

3.4 GAGE-CHEK 2000 – switch-on and switch-off

3.4.1 Switching on the GAGE-CHEK 2000

 Before using the product, you need to perform the commissioning and setup steps. Depending on the purpose of use, you may have to configure additional setup parameters.
Further information: "Commissioning", Page 74

- ▶ Turn the power switch on
The power switch is located on the rear side of the product
- > The unit powers up. This can take a moment.
- > If automatic user login is active and the last user who logged in was of the **Operator** type, the user interface opens with the **Measure** menu.
- > If automatic user login is not active, the **User login** menu is displayed.
Further information: "User login and logout", Page 25

3.4.2 Activating and deactivating the energy saving mode

If you will not be using the unit for a while, you should activate the energy-saving mode. This switches the unit to an inactive state without interrupting the power supply. The screen is switched off in this state.

Activating energy-saving mode



- ▶ Tap **Switch off** in the main menu



- ▶ Tap **Energy-saving mode**
- > The screen switches off.

Deactivating energy-saving mode



- ▶ Tap anywhere on the touchscreen
- > An arrow appears at the bottom of the screen.
- ▶ Drag the arrow up
- > The screen is switched on and shows the user interface last displayed.



3.4.3 Switching off the GAGE-CHEK 2000

NOTICE	
<p>Damage to the operating system!</p> <p>Disconnecting the power source while the product is on can damage the operating system of the product.</p> <ul style="list-style-type: none"> ▶ Use the Switch-off menu to shut down the product ▶ Do not disconnect the power source while the product is on ▶ Do not turn the power switch off until the product has shut down 	



- ▶ Tap **Switch off** in the main menu



- ▶ Tap **Shut down**
- > The operating system shuts down.
- ▶ Wait until the following message appears on the screen:
You can switch off the device now.
- ▶ Turn the power switch off

3.5 User login and logout

In the **User login** menu, you can log in and out of the product as a user.

Only one user can be logged in to the product at a time. The logged-in user is displayed. Before a new user can log in, the logged-in user has to log out.

<div style="display: flex; align-items: center;"> <p>The product provides various authorization levels that grant the user full or restricted access to management and operation functionality.</p> </div>
--

3.5.1 User login



- ▶ Tap **User login** in the main menu
- ▶ Select the user in the drop-down list
- ▶ Tap the **Password** input field
- ▶ Enter the user's password

User	Default password	Target group
OEM	oem	Commissioner, machine tool builder
Setup	setup	Setup engineer, system configurer
Operator	operator	Operator



If a password other than the default password has been assigned to the user, ask a **Setup** or **OEM** user for the assigned password.
If the password is no longer known, contact a HEIDENHAIN service agency.

- ▶ Confirm entry with **RET**
- ▶ Tap **Log in**
- > The user is logged in and the **Measure** menu is displayed.



Further information: "Target groups according to user types", Page 12

3.5.2 User logout



- ▶ Tap **User login** in the main menu



- ▶ Tap **Log out**
- > The user is logged out.
- > All functions of the main menu are inactive, except for **Switch off**.
- > The product can only be used again after a user has logged in.



3.6 Setting the language

The user interface language is English. You can change to another language, if desired.



- ▶ Tap **Settings** in the main menu



- ▶ Tap **User**
 - > The logged-in user is indicated by a check mark.
 - ▶ Select the logged-in user
 - > The language selected for the user is indicated by a national flag in the **Language** drop-down list.
 - ▶ Select the flag for the desired language from the **Language** drop-down list
 - > The user interface is displayed in the selected language.

3.7 Performing the reference mark search after startup

i If the reference mark search after unit start is active, then all of the unit's functions will be disabled until the reference mark search has been successfully completed.
Further information: "Reference marks (Encoder)", Page 91

i For encoders with EnDat interface, the reference mark search is omitted because the axes are referenced automatically.

If the reference mark search is active on the unit, then a wizard will ask you to traverse the reference marks of the axes.

- ▶ After logging in, follow the instructions of the wizard
- > The Reference symbol stops blinking upon successful completion of the reference mark search.

Further information: "Operating elements of the position display", Page 34

Further information: "Activating the reference mark search", Page 117

3.8 User interface

i The unit is available in different versions, which are variously equipped. The user interface and available functions may vary depending on the version.

3.8.1 User interface after switch-on

Factory default user interface

The figure shows the user interface in the product's factory default setting.

This user interface will also be displayed after the product has been reset to its factory default setting.

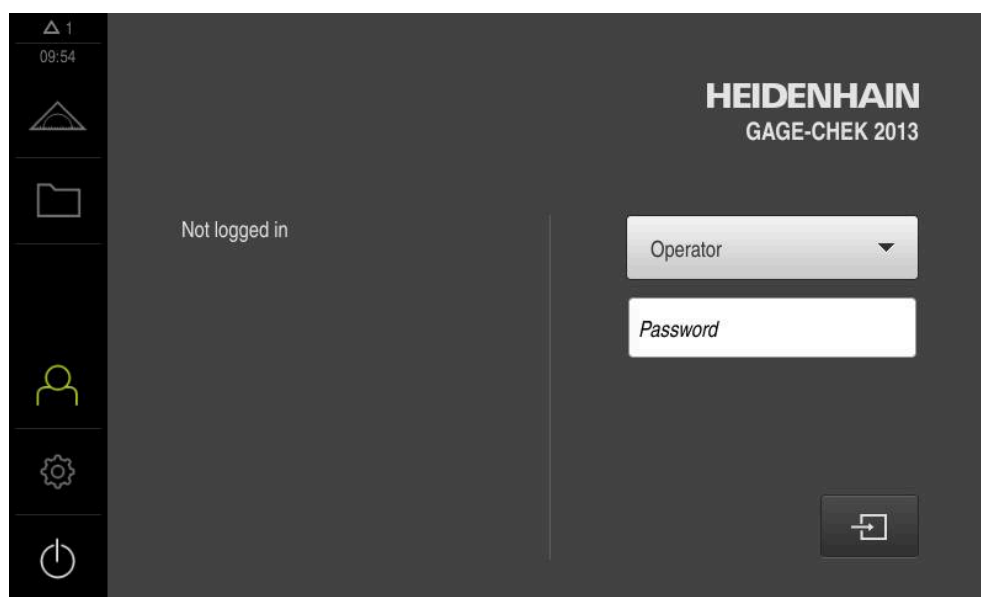

Figure 2: The user interface in the product's factory default setting

User interface after start-up

If automatic user login is activated, and the last user who logged in was of the **Operator** type, then the product displays the **Measure** menu with the workspace and the function bar after starting up.

Further information: "Measure menu", Page 30

If automatic user login is not activated, then the product opens the **User login** menu.

Further information: "User login menu", Page 32

3.8.2 Main menu of the user interface

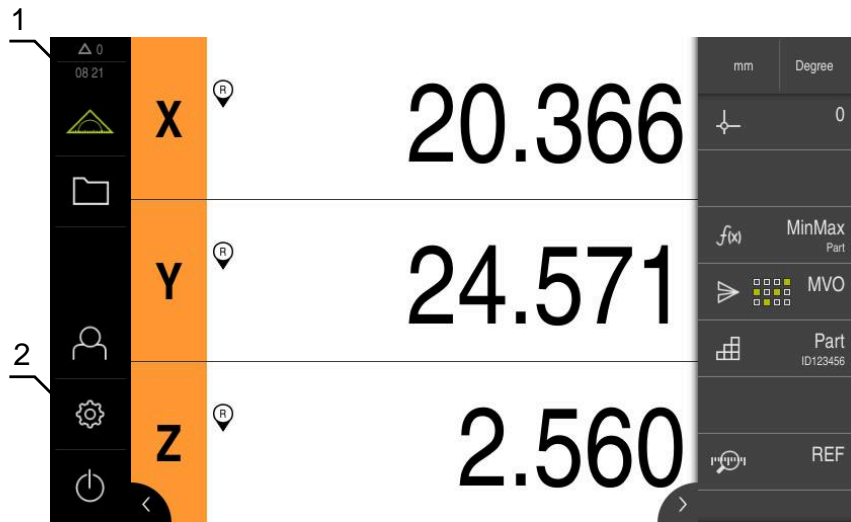







Figure 3: User interface

- 1 Message display area, displays the time and the number of unclosed messages
- 2 Main menu with operating elements

Main menu operating elements

Operating element	Function
	<p>Message</p> <p>Display of an overview of all messages as well as the number of messages that have not been closed</p> <p>Further information: "Messages", Page 41</p>
	<p>Measure</p> <p>Positioning and measurement of minimum, maximum, and range; perform relative measurements</p> <p>Further information: "Measure menu", Page 30</p>
	<p>File management</p> <p>Management of the files that are available on the product</p> <p>Further information: "File management menu", Page 31</p>
	<p>User login</p> <p>Login and logout of the user</p> <p>Further information: "User login menu", Page 32</p>
	<div style="border: 1px solid black; padding: 5px; margin-bottom: 10px;"> <p>i If a user with additional permissions (Setup or OEM user type) is logged in, then the gear symbols appears.</p> </div> <p>Settings</p> <p>Settings of the product, such as setting up users, configuring sensors, or updating the firmware</p> <p>Further information: "Settings menu", Page 33</p>

Operating element	Function
	<p>Switch-off</p> <p>Shutdown of the operating system or activation of power-saving mode</p> <p>Further information: "Switch-off menu", Page 34</p>

3.8.3 Measure menu

Call



- ▶ Tap **Measure** in the main menu
- The user interface for measuring and positioning is displayed.

Short description

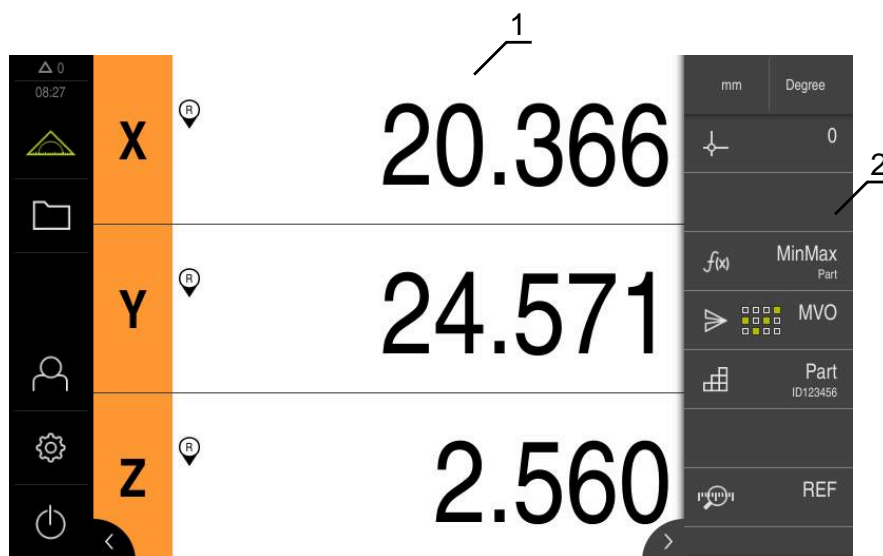

Figure 4: **Measure** menu

- 1 The workspace shows the current position of the measuring plate
- 2 The function bar provides the quick access menu and the function elements

3.8.4 File management menu

Call



- ▶ Tap **File management** in the main menu
- > The file management user interface is displayed.

Short description

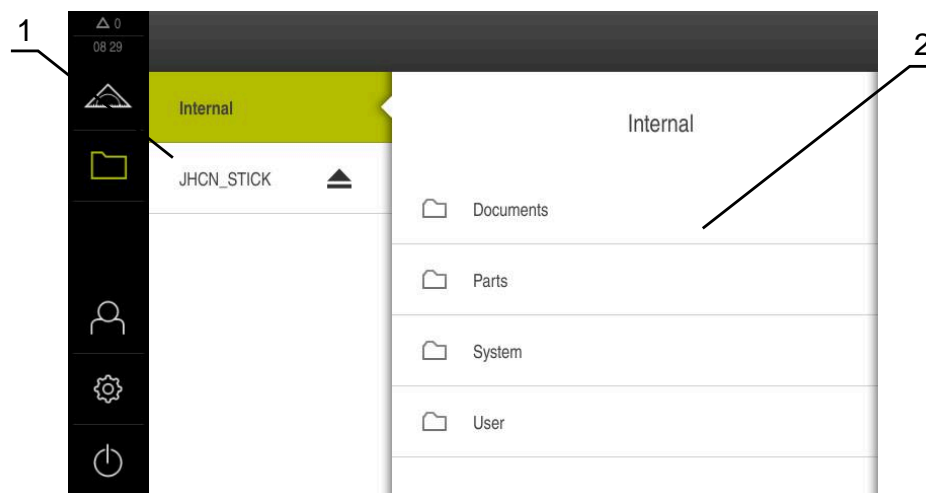

Figure 5: **File management** menu

- 1** List of available storage locations
- 2** List of folders in the selected storage location

The **File management** menu shows an overview of the files stored in the product's memory.

Any connected USB mass storage devices (FAT32 format) or available network drives are shown in the list of storage locations. The USB mass storage devices and the network drives are displayed with their name or drive designation.

Further information: "File Management", Page 151

3.8.5 User login menu

Call



- ▶ Tap **User login** in the main menu
- > The user interface for user login and logout is displayed.

Short description

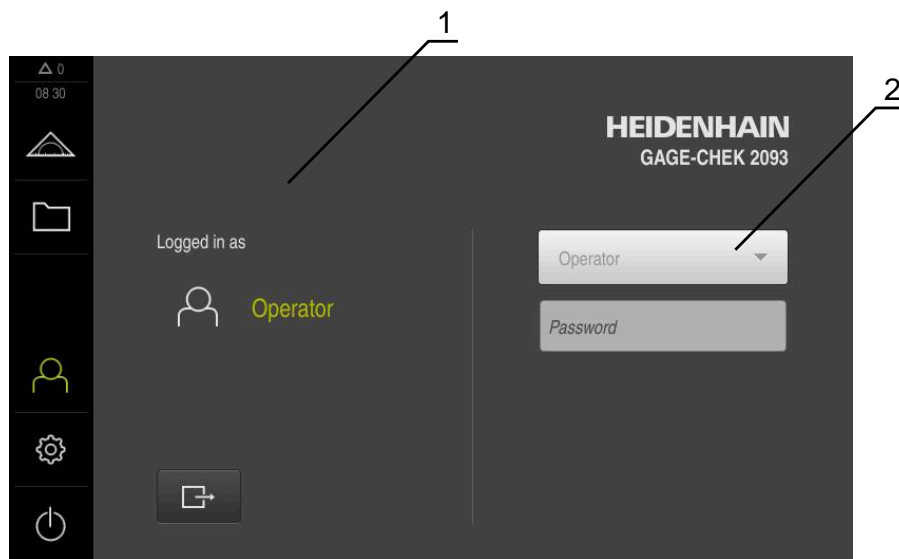

Figure 6: **User login** menu

- 1 Display of the logged-in user
- 2 User login

The **User login** menu shows the logged-in user in the column on the left. The login of a new user is displayed in the right-hand column.

To log in another user, the logged-in user must first log out.

Further information: "User login and logout", Page 25

3.8.6 Settings menu

Call



- ▶ Tap **Settings** in the main menu
- > The user interface for the product settings is displayed.

Short description

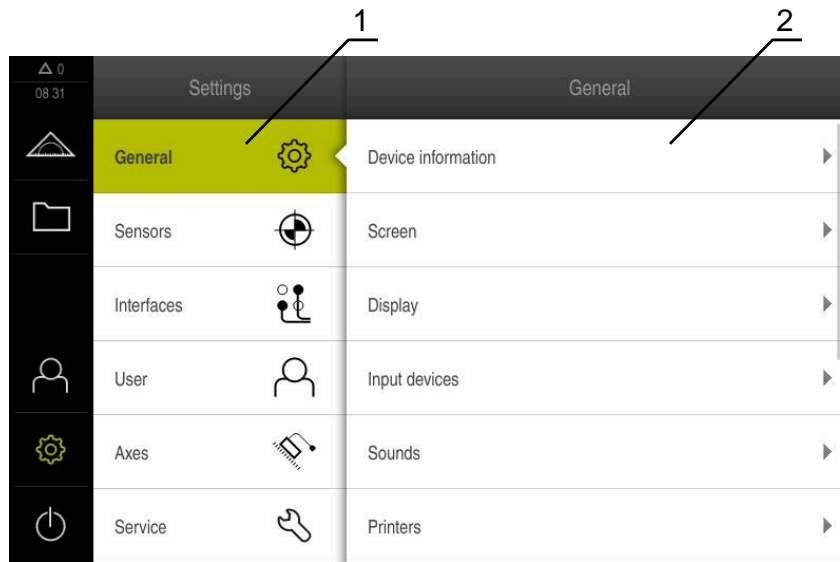

Figure 7: **Settings** menu

- 1 List of setting options
- 2 List of setting parameters

The **Settings** menu shows all of the options for configuring the product. The settings parameters allow you to adapt the product to on-site requirements.

Further information: "Settings", Page 158

i The product provides various authorization levels that grant the user full or restricted access to management and operation functionality.

3.8.7 Switch-off menu

Call



- ▶ Tap **Switch off** in the main menu
- The operating elements for shutting down the operating system, for activating the energy-saving mode and for activating the cleaning mode are displayed.

Short description

The **Switch off** menu provides the following options:

Operating element	Function
	Shut down Shuts down the operating system
	Energy saving mode Switches the screen off and puts the operating system into energy-saving mode
	Cleaning mode Switches the screen off; the operating system continues unchanged

Further information: "GAGE-CHEK 2000 – switch-on and switch-off", Page 24

Further information: "Cleaning the screen", Page 174



3.9 Position display

The unit's position display shows the axis positions and additional information about the configured axes (if applicable).

3.9.1 Operating elements of the position display

Symbol	Meaning
	Axis key Axis key functions: <ul style="list-style-type: none"> ■ Tapping the axis key: opens the input field for position value ■ Holding down the axis key: sets the current position as zero point
	Reference mark search performed successfully
	Reference mark search not performed or no reference mark detected
	Minimum: Lowest measured value (if the MinMax function is active)



Symbol	Meaning
	Maximum: Highest measured value (if the MinMax function is active)
	Range: Difference between the maximum and minimum (if the MinMax function is active)
	Position value is equivalent to the diameter (when D/R function activated)

3.10 Customizing the workspace

In the **Measure** menu, you can enlarge the workspace by hiding the main menu or the function bar.

Call



- ▶ Tap **Measure** in the main menu
- > The user interface for measuring and positioning is displayed.

3.10.1 Hiding and showing the main menu



- ▶ Tap the **tab**
- > The main menu is hidden.
- > The arrow changes direction.
- ▶ To show the main menu, tap the **tab** again

3.10.2 Hiding or displaying the function bar



- ▶ Tap the **tab**
- > The function bar is hidden.
- > The arrow changes direction.
- ▶ To show the function bar, tap the **tab** again

3.10.3 Scrolling the function bar

The function bar becomes scrollable if it has more function elements than can be displayed at one time. When you assign a function to the empty bottom field, an empty field will be added to the bar. Now you can scroll the function bar.



- ▶ Swipe up or down on the function bar
- > The functions are scrolled up or down.

3.10.4 Moving functions on the function bar

You can move the functions on the function bar by drag-and-drop as needed.



- ▶ Hold a function on the function bar
- > The drag-and-drop mode is activated. The function bar is displayed dark.



- ▶ Touch a function and drag it to the desired location
- ▶ To end the drag-and-drop mode, tap a function
- > The function bar is displayed bright.

3.11 Using the function bar



The operation of the function bar may be restricted.

Contact your OEM or Setup user.

Further information: "Function bar", Page 163

3.11.1 Operating elements of the function bar

The function bar provides the following areas and operating elements:

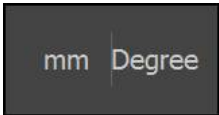

Operating element	Function
	<p>Quick access menu</p> <p>The quick access menu displays the current settings:</p> <ul style="list-style-type: none"> ■ Unit for linear values (Millimeters or Inch) ■ Unit for angular values (Radian, Decimal degrees, or Deg-Min-Sec) ▶ To adjust the settings of the quick access menu, tap the quick access menu <p>Further information: "Adjusting settings in the quick access menu", Page 40</p>

3.11.2 Function elements

Function elements are operating elements that you can add to the function bar and configure individually.







The following function elements are available:

Basic functions



Function element	Short description
	<p>Presets</p> <p>Displays the current preset; tapping opens the preset table</p> <p>Further information: "Preset", Page 202</p>
	<p>Calculator</p> <p>Tapping opens a calculator with basic mathematical functions; the last result is shown in the calculator and on the function bar</p>
	<p>Reference mark search (REF)</p> <p>Tapping starts the reference mark search</p>

Functions for measurements

Function element	Short description
	<p>Part</p> <p>Groups all relevant functions; tapping hides all functions that are irrelevant to the measurement</p> <p>Further information: "Management of parts", Page 238</p>



Function element	Short description
	<p>Mastering</p> <p>Saves the measured values of a reference part as master or adopts the position values of the position display as master; corresponding axes can be selected</p> <p>Further information: "Mastering", Page 220</p>
	<p>dial gage</p> <p>Displays the nominal values, warning thresholds, and tolerance limits via a dial gage; tapping opens the views of the dial gage function</p> <p>Further information: "Dial gage", Page 223</p>
	<p>MinMax</p> <p>Acquires the minimum, maximum, and range; tapping starts the acquisition of measured values according to the configuration</p> <p>Further information: "Minimum, maximum, and range", Page 212</p>
	<p>Formula</p> <p>Offsetting of axis values; tap to activate the formula according to the configuration</p> <p>Further information: "Formula", Page 232</p>
	<p>Relative</p> <p>Tapping activates Relative measurement; the zeroing of axes or the overwriting of a position value has no effect on the selected preset when the Relative function is activated</p> <p>Further information: "Relative measurement", Page 218</p>
	<p>D/R</p> <p>Displays the position values of radial axes; tapping switches from radius to diameter; the product displays the doubled position value</p> <p>Further information: "Diameter/Radius", Page 216</p>

Functions for measured value output

Function element	Short description
	<p>Manual output of measured values</p> <p>Sends the measured values to a computer; tapping starts the data transfer according to the configuration</p> <p>Further information: "Sending measured values to a computer", Page 245</p>
	<p>Measured value output triggered by touch probe</p> <p>Sends the measured values to a computer; tapping activates the automatic output of measured values according to the configuration; the data is transferred when the stylus is deflected</p> <p>Further information: "Sending measured values to a computer", Page 245</p>

Function element	Short description
	<p>Continuous output of measured values</p> <p>Sends the measured values to a computer; tapping activates the automatic output of measured values according to the configuration; the data is transferred continuously at intervals of approx. 200 ms</p> <p>Further information: "Sending measured values to a computer", Page 245</p>

Functions for probing

Function element	Short description
	<p>Edge probing (probing)</p> <p>Tapping starts the wizard for probing an object of measurement</p> <p>Further information: "Probing functions", Page 209</p>
	<p>Determining the center line (probing)</p> <p>Tapping starts the wizard for probing an object of measurement</p> <p>Further information: "Probing functions", Page 209</p>
	<p>Determining the circle center (probing)</p> <p>Tapping starts the wizard for probing an object of measurement</p> <p>Further information: "Probing functions", Page 209</p>

Adding a function element to the function bar

- ▶ Drag an empty function bar field to the left into the workspace
- > A dialog box with all of the available function elements opens.
- ▶ Tap the desired function element
- > The function element is now available.

Removing a function element from the function bar

 The operation of the function bar may be restricted. Contact your OEM or Setup user.

Further information: "Function bar", Page 163

- ▶ Drag the function element to the right
- ▶ Tap **Delete**
- > The function element is removed.



Configuring function elements

You can configure the functions that you have assigned to the function bar.

- ▶ Drag the function element to the left and into the workspace
- > A dialog box for configuration appears.
- ▶ Configure the function element
- ▶ Tap **Close**
- > The selection is saved.



The procedure is identical for all function elements.
For more information on the function elements, please refer to the "Information for the operator" chapter.

Further information: "Information for the Operator", Page 195

Saving the configuration of function elements



The function elements **dial gage**, **Mastering**, **Measured value output** and **MinMax** allow you to save your configuration and open a configuration that has been saved.



The operation of the function bar may be restricted.
Contact your OEM or Setup user.

Further information: "Function bar", Page 163



- ▶ Drag the function element to the right
- ▶ Tap **Save**
- > The **Save configuration** dialog box appears.
- ▶ Select the folder in which the configuration should be saved
- ▶ Enter a name for the file
- ▶ Confirm entry with **RET**
- ▶ Tap **Save**
- > The file has been saved.



You can export or import saved configurations from or to your device via a USB mass storage product.

Further information: "Exporting files", Page 156

Further information: "Importing files", Page 156

Opening the configuration of function elements



The operation of the function bar may be restricted.
Contact your OEM or Setup user.

Further information: "Function bar", Page 163



- ▶ Drag the function element to the right
- ▶ Tap **Open**
- > The **Open configuration** dialog is opened.
- ▶ Navigate to the folder in which the file is saved
- ▶ Tap the desired file
- ▶ Tap **Open**
- > The file is opened.

3.11.3 Adjusting settings in the quick access menu

In the quick access menu, you can adjust the following settings:

- Unit for linear values (**Millimeters** or **Inch**)
- Unit for angular values (**Radian**, **Decimal degrees**, or **Deg-Min-Sec**)



The available settings depend on the configuration of the product and the enabled software options.

Setting the units of measure

Before you start measuring, you need to set the desired units of measure in the quick access menu.

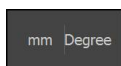

- ▶ Tap the **quick access menu** on the function bar
- ▶ Select the desired **Unit for linear values**
- ▶ Select the desired **Unit for angular values**
- ▶ To close the quick access menu, tap **Close**
- > The selected units are displayed in the **quick access menu**.





3.12 Messages and audio feedback

3.12.1 Messages

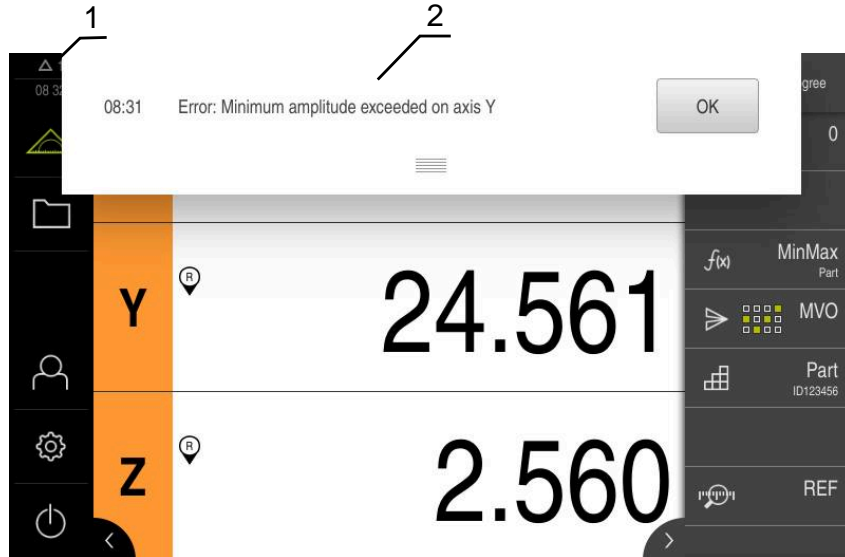

Figure 8: Display of messages in the workspace

- 1 Message display area; displays the time and the number of unclosed messages
- 2 Message list

The messages that appear at the top of the workspace are triggered by, for example, operator errors or uncompleted processes.

The messages are displayed upon occurrence of the message cause or via tapping on the **Messages** display area at the top left of the screen.

Viewing messages

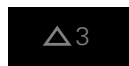

- ▶ Tap **Messages**
- > The message list opens.

Resizing the display area



- ▶ To enlarge the message display area, drag the **handle** down
- ▶ To make the message display area smaller, drag the **handle** up
- ▶ To close the display area, drag the **handle** up out of the screen
- > The number of messages that have not been closed is indicated in **Messages**.

Closing messages

Depending on the content of the messages, you can close messages by means of the following operating elements:



- ▶ To close an informational message, tap **Close**
- > The message disappears.

or

- ▶ To close a message that potentially has an effect on the application, tap **OK**
- > If applicable, the message will now be taken into account by the application.
- > The message disappears.

3.12.2 Wizard

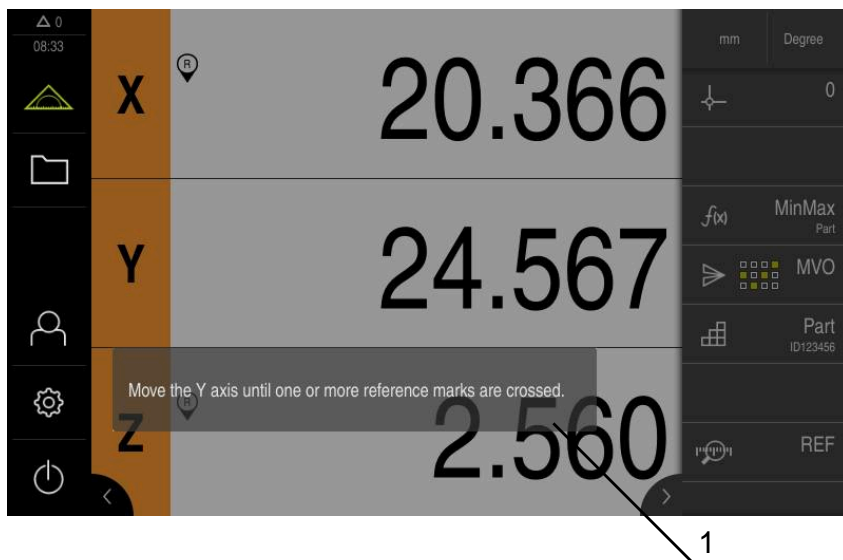

Figure 9: Display of messages in the wizard

1 Wizard (example)

The wizard supports you when you are performing actions and teach sequences or when you are running programs.

You can move the wizard within the workspace .

The following operating elements of the wizard are shown based on the action step or process.



- ▶ To return to the last action step or to repeat the process, tap **Undo**



- ▶ To confirm the displayed action step, tap **Confirm**
- > The wizard proceeds to the next step or completes the process.



- ▶ Tap **Close** to close the wizard

3.12.3 Audio feedback

The product can provide audio feedback to indicate user actions, completed processes or malfunctions.

The available sounds are grouped into categories. The sounds differ within a category.

You can define the audio feedback settings in the **Settings** menu.

Further information: "Sounds", Page 162

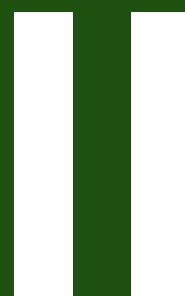

**Information for OEM
and Setup Users**

Overview

This part of the documentation contains important information for the OEM and Setup users to enable them to put the product into service and set it up properly.

Contents of chapters in the "Information for OEM and Setup Users" part

The table below shows:

- The chapters included in this "Information for OEM and Setup Users" part
- The information contained in these chapters
- The target groups that these chapters are mainly intended for

Chapter	Contents	Target group		
		OEM	Setup	Operator
	This chapter contains information about...			
1 "Transport and Storage"	... transporting the product ... storing the product ... items supplied with the product ... accessories for the product	✓	✓	
2 "Mounting"	... correct mounting of the product	✓	✓	
3 "Installation"	... correct installation of the product	✓	✓	
4 "Commissioning"	... commissioning the product	✓		
5 "Setup"	... correct setup of the product		✓	
6 "File Management"	... the functions of the "File management" menu	✓	✓	✓
7 "Settings"	... setting options and associated setting parameters for the product	✓	✓	✓
8 "Servicing and Maintenance"	... general maintenance work on the product	✓	✓	✓
9 "Removal and Disposal"	... removal and disposal of the product ... environmental protection specifications	✓	✓	✓
10 "Specifications"	... the technical data of the product ... product dimensions and mating dimensions (drawings)	✓	✓	✓

Contents

1	Transport and Storage.....	50
1.1	Overview.....	51
1.2	Unpacking.....	51
1.3	Items supplied and accessories.....	51
	1.3.1 Items supplied.....	51
	1.3.2 Accessories.....	52
1.4	In case of damage in transit.....	54
1.5	Repackaging and storage.....	54
	1.5.1 Repackaging the product.....	55
	1.5.2 Storage of the product.....	55
2	Mounting.....	56
2.1	Overview.....	57
2.2	Assembly of the product.....	57
	2.2.1 Mounting on Single-Pos stand.....	58
	2.2.2 Mounting on Duo-Pos stand.....	59
	2.2.3 Mounting on Multi-Pos stand.....	60
	2.2.4 Mounting on Multi-Pos holder.....	61
3	Installation.....	62
3.1	Overview.....	63
3.2	General information.....	63
3.3	Device overview.....	64
3.4	Connecting encoders.....	66
3.5	Connecting touch probes.....	67
3.6	Wiring switching inputs and outputs.....	68
3.7	Connecting input devices.....	72
3.8	Connecting a network peripheral.....	72
3.9	Connecting the line voltage.....	73
4	Commissioning.....	74
4.1	Overview.....	75
4.2	Logging in for commissioning.....	75
	4.2.1 User login.....	75
	4.2.2 Performing the reference mark search after startup.....	76
	4.2.3 Setting the language.....	76
	4.2.4 Changing the password.....	77
4.3	Steps for commissioning.....	77
4.4	Basic settings.....	78
	4.4.1 Activating Software options.....	78
	4.4.2 Setting the date and time.....	81
	4.4.3 Setting the units of measure.....	81
4.5	Configuring a touch probe.....	82
4.6	Configuring the axes.....	83
	4.6.1 Configuring Alias assignment for axis names.....	83
	4.6.2 Overview of typical encoders.....	84
	4.6.3 Configuring axes for encoders with EnDat interface.....	87
	4.6.4 Configuring the axes for encoders with a 1 V _{PP} or 11 μA _{PP} interface.....	88

4.6.5	Configuring axes for encoders with TTL interface.....	93
4.6.6	Performing error compensation.....	97
4.6.7	Coupling axes.....	115
4.6.8	Reference marks.....	116
4.7	OEM area.....	117
4.7.1	Adding documentation.....	118
4.7.2	Adding a startup screen.....	118
4.7.3	Configuring the unit for screenshots.....	119
4.8	Backing up data.....	120
4.8.1	Back up settings.....	120
4.8.2	Back up user files.....	121

5 Setup..... 122

5.1	Overview.....	123
5.2	Logging in for setup.....	123
5.2.1	User login.....	123
5.2.2	Performing the reference mark search after startup.....	124
5.2.3	Setting the language.....	124
5.2.4	Changing the password.....	125
5.3	Single steps for setup.....	126
5.3.1	Setting the date and time.....	127
5.3.2	Setting the units of measure.....	127
5.3.3	Entering and configuring users.....	128
5.3.4	Adding the Operating Instructions.....	130
5.3.5	Configuring the network.....	131
5.3.6	Configuring the network drive.....	132
5.3.7	Configuring operation with a mouse or touchscreen.....	133
5.3.8	Configuring the RS-232 interface.....	133
5.3.9	Network protocols.....	141
5.3.10	Switching functions.....	141
5.3.11	Remote access.....	142
5.3.12	Activating the interface for Data transfer.....	147
5.4	Back up settings.....	149
5.5	Back up user files.....	150

6 File Management..... 151

6.1	Overview.....	152
6.2	File types.....	153
6.3	Managing folders and files.....	153
6.4	Viewing and opening files.....	155
6.5	Exporting files.....	156
6.6	Importing files.....	156

7 Settings..... 158

7.1	Overview.....	159
7.2	General.....	160
7.2.1	Device information.....	160
7.2.2	Screen.....	161
7.2.3	Display.....	161
7.2.4	Sounds.....	162
7.2.5	Printers.....	162
7.2.6	Function bar.....	163
7.2.7	Copyrights.....	163

	7.2.8	Service info.....	163
	7.2.9	Documentation.....	163
7.3		Sensors.....	164
7.4		Interfaces.....	165
	7.4.1	USB.....	165
7.5		User.....	166
	7.5.1	OEM.....	166
	7.5.2	Setup.....	166
	7.5.3	Operator.....	167
7.6		Axes.....	168
	7.6.1	Information.....	169
7.7		Service.....	170
	7.7.1	Firmware information.....	171
8		Servicing and Maintenance.....	173
8.1		Overview.....	174
8.2		Cleaning.....	174
8.3		Maintenance plan.....	175
8.4		Resuming operation.....	175
8.5		Updating the firmware.....	175
8.6		Encoder diagnostics.....	177
	8.6.1	Diagnostics for encoders with 1 V _{PP} /11 μA _{PP} interface.....	177
	8.6.2	Diagnostics for encoders with EnDat interface.....	178
8.7		Restoring files and settings.....	180
	8.7.1	Restore OEM-specific folders and files.....	181
	8.7.2	Restore user files.....	182
	8.7.3	Restoring settings.....	183
8.8		Reset all settings.....	184
8.9		Reset to shipping conditions.....	184
9		Removal and Disposal.....	185
9.1		Overview.....	186
9.2		Removal.....	186
9.3		Disposal.....	186
10		Specifications.....	187
10.1		Overview.....	188
10.2		Product data.....	188
10.3		Product dimensions and mating dimensions.....	190
	10.3.1	Product dimensions with Single-Pos stand.....	192
	10.3.2	Product dimensions with Duo-Pos stand.....	193
	10.3.3	Product dimensions with Multi-Pos stand.....	193
	10.3.4	Product dimensions with Multi-Pos holder.....	194

1

**Transport and
Storage**

1.1 Overview

This chapter contains information on the transportation and storage of the product and provides an overview of the items supplied and the available accessories for the product.



The following steps must be performed only by qualified personnel.

Further information: "Personnel qualification", Page 16

1.2 Unpacking

- ▶ Open the top lid of the box
- ▶ Remove the packaging materials
- ▶ Unpack the contents
- ▶ Check the delivery for completeness
- ▶ Check the delivery for damage

1.3 Items supplied and accessories

1.3.1 Items supplied

The following items are included in delivery:

Name	Description
Addendum (optional)	Supplements or supersedes the contents of the Operating Instructions and, if applicable, of the Installation Instructions.
Operating Instructions	PDF issue of the Operating Instructions on a memory medium in the currently available languages
Product	Evaluation Unit GAGE-CHEK 2000
Installation Instructions	Printed issue of the Installation Instructions in the currently available languages
Single-Pos stand	Stand for rigid mounting, inclination angle 20°, fixing hole pattern 50 mm x 50 mm

1.3.2 Accessories



Software options need to be enabled on the product via a license key. Before you can use the associated hardware components, you need to enable the respective software option.

Further information: "Activating Software options", Page 78

The following accessories are optionally available and can be ordered from HEIDENHAIN:

Accessories	Name	Description	ID
For installation			
	15-pin/9-pin TTL adapter cable	Pin layout conversion of the TTL interface from D-sub connector, 2-row, female, 15-pin to D-sub connector, 2-row, with locking screws, male, 9-pin	1396674-N5
	Adapter cable for touch-probe connection, DIN 5-pin female	Conversion of the pin layout from HEIDENHAIN touch probe interface to Renishaw touch probe interface	1095709-xx
	Adapter connector for 11 μ App	Conversion of the 11 μ App interface from installation in D-sub connector, 2-row, female, 9-pin to D-sub connector, 2-row, with locking screws, male, 15-pin	1089213-01
	Adapter connector for 1 Vpp	Conversion of the 1 Vpp interface from installation in D-sub connector, 2-row, male, 15-pin to D-sub connector, 2-row, with locking screws, male, 15-pin	1089214-01
	Adapter connector for 2 Vpp	Pin layout conversion from HEIDENHAIN 1 Vpp to Mitutoyo-2 Vpp	1089216-01
	Adapter connector for TTL	Conversion of the pin layout from HEIDENHAIN TTL to RSF TTL and Renishaw TTL	1089210-01
	Cables	For information on connecting cables, see "Cables and Connectors for HEIDENHAIN Products" brochure.	---
	Foot switch	Foot switch for external operation with two freely assignable keys; cable length 2.4 m	681041-04
	KT 130 edge finder	Touch probe for probing a workpiece (for setting presets)	283273-xx
	Power cable	Power cable with European plug (type F), length: 3 m	223775-01

Accessories	Name	Description	ID
	RS-232 connecting cable	RS-232 connecting cable, complete with two 9-pin D-sub connectors (female)	366964-xx
	TS 248 touch probe	Touch probe for probing a workpiece (for setting presets), axial cable outlet	683110-xx
	TS 248 touch probe (radial)	Touch probe for probing a workpiece (for setting presets), radial cable outlet	683112-xx
	USB connecting cable	USB connecting cable for connector type A to type B	354770-xx
For mounting			
	Duo-Pos stand	Stand for rigid mounting, inclination angle 20° or 45°, fixing hole pattern 50 mm x 50 mm	1089230-06
	Mounting arm	Mounting arm for mounting to a machine	1089207-01
	Multi-Pos holder	Holder for fastening the device on an arm, continuously tiltable within an angle of 90°, fixing hole pattern 50 mm x 50 mm	1089230-08
	Multi-Pos stand	Stand for continuously variable tilting with a tilting range of 90°, fixing hole pattern 50 mm x 50 mm	1089230-07
	Single-Pos stand	Stand for rigid mounting, inclination angle 20°, fixing hole pattern 50 mm x 50 mm	1089230-05

Recommended RS-232 adapters

HEIDENHAIN recommends the following RS-232 adapters:

Part no.	Model designation	Manufacturer	Interface	Conversion
DA-70156	DIGITUS USB – serial adapter	ASSMANN Electronic GmbH	USB 2.0	Serial
-	USB to RS232 connecting cable	STEINWALD datentechnik GmbH	USB 2.0	Serial
UC232R-10	USB - RS232 adapter cable	Future Technology Devices International Limited	USB 2.0	Serial

i If you connect a USB-to-RS232 connecting cable from the manufacturer STEINWALD datentechnik GmbH to the product, the data interface is configured automatically and is ready immediately. The data format **Steinwald** is used for measured value output. The settings are not configurable.

i For more information on transferring data with products or the data format from **Steinwald**, please refer to:
 STEINWALD datentechnik GmbH
 +49 (9231) 9630-10
vertrieb@steinwald.com

1.4 In case of damage in transit

- ▶ Have the shipping agent confirm the damage
- ▶ Keep the packaging materials for inspection
- ▶ Notify the sender of the damage
- ▶ Contact the distributor or machine manufacturer for replacement parts

i If damage occurred during transit:

- ▶ Keep the packaging materials for inspection
- ▶ Contact HEIDENHAIN or the machine manufacturer

This applies also if damage occurred to requested replacement parts during transit.

1.5 Repackaging and storage

Repackage and store the product carefully in accordance with the conditions stated below.

1.5.1 Repackaging the product

Repackaging should correspond to the original packaging as closely as possible.

- ▶ Re-attach all mounting parts and dust protection caps to the product as received from the factory, or repackage them in the original packaging as received from the factory
- ▶ Repackage the product in such a way that
 - it is protected from impact and vibration during transit
 - it is protected from the ingress of dust or humidity
- ▶ Place all accessories that were included in the shipment in the original packaging
Further information: "Items supplied and accessories", Page 51
- ▶ Enclose all the documentation that was included in the original packaging
Further information: "Storage and distribution of the documentation", Page 11



If the product is returned for repair to the Service department:

- ▶ Ship the product without accessories, without encoders and without peripherals

1.5.2 Storage of the product

- ▶ Package the product as described above
- ▶ Observe the specified ambient conditions
Further information: "Specifications", Page 187
- ▶ Inspect the product for damage after any transport or longer storage times

2

Mounting

2.1 Overview

This chapter describes the mounting of the product. It contains instructions about how to correctly mount the product on stands or holders.

i The following steps must be performed only by qualified personnel.
Further information: "Personnel qualification", Page 16

2.2 Assembly of the product

General mounting information

The mount for the mounting variants is provided on the rear panel. The mounting hole pattern corresponds to a grid of 50 mm x 50 mm.

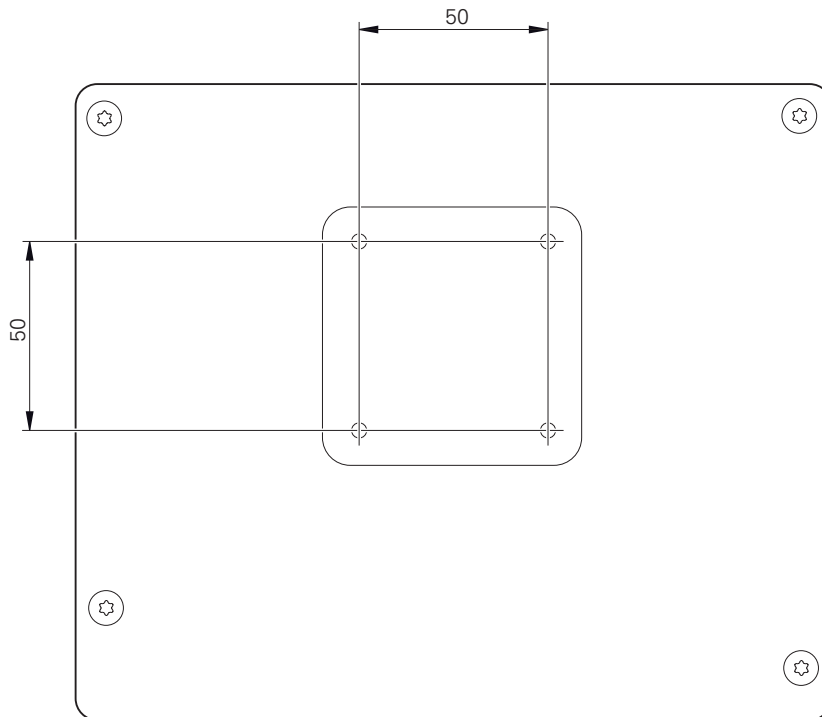

Figure 10: Dimensions of rear panel of the product

The materials for attachment of the mounting variants on the device are included in delivery.

You will also need the following:

- Torx T20 screwdriver
- Torx T25 screwdriver
- Allen key, size 2.5 (Duo-Pos stand)
- Materials for mounting on a supporting surface

i The unit must be mounted to a stand or a holder to ensure the correct and intended use of the product.

2.2.1 Mounting on Single-Pos stand

You can fasten the Single-Pos stand to the product at a 20° angle.

- ▶ Use the provided M4 x 8 ISO 14581 countersunk head screws to fasten the stand to the upper threaded holes on the rear panel



Comply with the permissible tightening torque of 2.6 Nm

- ▶ Fasten the stand with two suitable screws from above to a supporting surface or
- ▶ Attach self-adhesive rubber pads to the underside of the stand
- ▶ Route the cables from behind through the opening in the stand and then to the connections

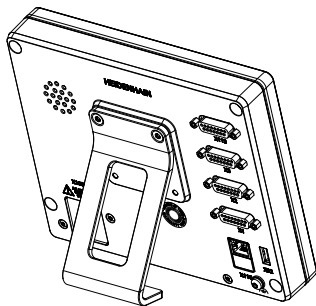

Figure 11: Product mounted on Single-Pos stand

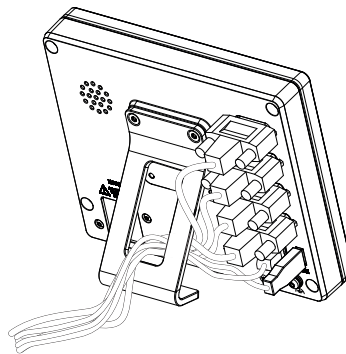

Figure 12: Cable routing on Single-Pos stand

Further information: "Product dimensions with Single-Pos stand", Page 192

2.2.2 Mounting on Duo-Pos stand

You can fasten the Duo-Pos stand to the product at a 20° or 45° angle.

i If you screw the Duo-Pos stand into the product at a 45° angle, you must attach the product at the upper end of the mounting slots. Use a power cable with an angled connector.

- ▶ Use the provided M4 x 8 ISO 7380 hexagon socket screws to fasten the stand to the lower threaded holes on the rear panel

i Comply with the permissible tightening torque of 2.6 Nm

- ▶ Using the mounting slots (width = 4.5 mm), screw the stand to a supporting surface
- or
- ▶ Set up the device freely at the desired location
- ▶ Route the cable from behind through the two supports of the stand and then through the lateral openings to the connections

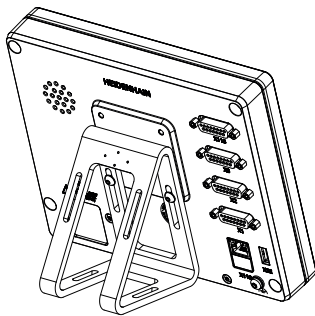

Figure 13: Product mounted on Duo-Pos stand

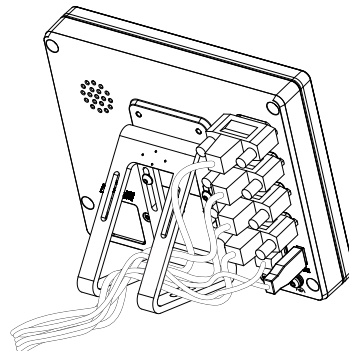

Figure 14: Cable routing on Duo-Pos stand

Further information: "Product dimensions with Duo-Pos stand", Page 193

2.2.3 Mounting on Multi-Pos stand

- ▶ Use the provided M4 x 8 ISO 14581 countersunk head screws (black) to fasten the stand to the threaded holes on the rear panel

i Comply with the permissible tightening torque of 2.6 Nm

- ▶ Using two M5 screws, you can also optionally screw the stand to a supporting surface from the bottom
- ▶ Adjust the desired angle of inclination
- ▶ To fix the stand: Tighten the T25 screw

i Comply with the tightening torque for screw T25

- Recommended tightening torque: 5.0 Nm
- Maximum permissible tightening torque: 15.0 Nm

- ▶ Route the cable from behind through the two supports of the stand and then through the lateral openings to the connections

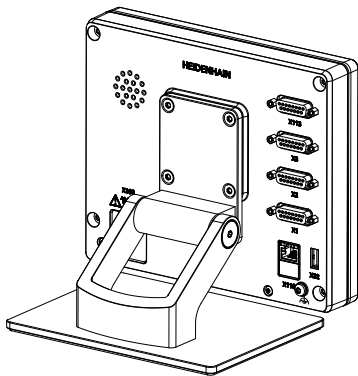

Figure 15: Product mounted on Multi-Pos stand

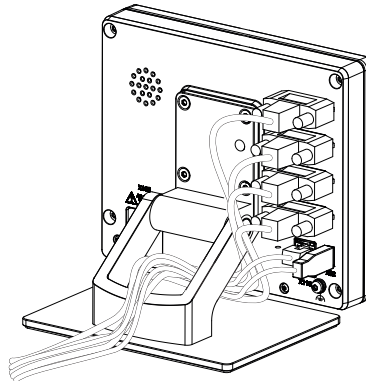

Figure 16: Cable routing on Multi-Pos stand

Further information: "Product dimensions with Multi-Pos stand", Page 193

2.2.4 Mounting on Multi-Pos holder

- ▶ Use the provided M4 x 8 ISO 14581 countersunk head screws (black) to fasten the holder to the threaded holes on the rear panel



Comply with the permissible tightening torque of 2.6 Nm

- ▶ Mount the holder with the supplied M8 screw, the washers, the handle and the M8 hexagon nut to an arm
- or
- ▶ Mount the holder with two screws <7 mm through the two holes to the intended surface
- ▶ Adjust the desired angle of inclination
- ▶ To fix the holder in place: tighten the T25 screw



Comply with the tightening torque for screw T25

- Recommended tightening torque: 5.0 Nm
- Maximum permissible tightening torque: 15.0 Nm

- ▶ Route the cable from behind through the two supports of the holder and then through the lateral openings to the connections

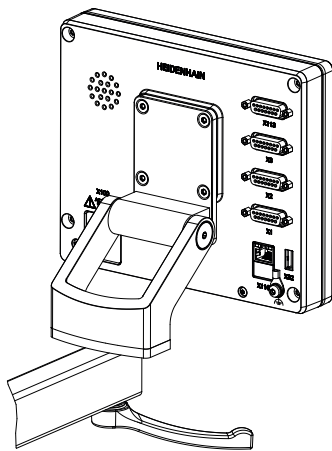

Figure 17: Product mounted on Multi-Pos holder

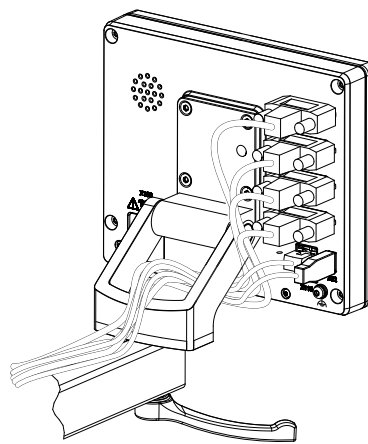

Figure 18: Cable routing on Multi-Pos holder

Further information: "Product dimensions with Multi-Pos holder", Page 194

3

Installation

3.1 Overview

This chapter describes the Installation of the product. It contains information about the product's connections and instructions about how to correctly connect the peripheral devices.



The following steps must be performed only by qualified personnel.

Further information: "Personnel qualification", Page 16

3.2 General information

NOTICE

Interference from sources of high electromagnetic emission!

Peripheral devices, such as frequency inverters or servo drives, may cause interference.

To increase the noise immunity to electromagnetic influences:

- ▶ Use the optional functional ground connection as per IEC/EN 60204-1
- ▶ Use only USB peripherals with continuous shielding, e.g. by metalized film and metal braiding or a metal housing. The degree of coverage provided by the braiding must be 85 % or higher. The shield must be connected around the entire circumference of the connectors (360° connection).

NOTICE

Damage to the device from the engaging and disengaging of connecting elements during operation!

Damage to internal components may result.

- ▶ Do not engage or disengage any connecting elements while the unit is under power

NOTICE

Electrostatic discharge (ESD)!

This device contains electrostatic sensitive components that can be destroyed by electrostatic discharge (ESD).

- ▶ It is essential to observe the safety precautions for handling ESD-sensitive components
- ▶ Never touch connector pins without ensuring proper grounding
- ▶ Wear a grounded ESD wristband when handling device connections

NOTICE**Damage to the product due to incorrect wiring!**

The incorrect wiring of inputs or outputs can cause damage to the product or to peripheral devices.

- ▶ Comply with the pin layouts and specifications of the product
- ▶ Assign only pins or wires that will be used

Further information: "Specifications", Page 187

3.3 Device overview

The connections on the rear panel of the device are protected by dust protection caps from contamination and damage.

NOTICE**Contamination or damage may result if the dust protection caps are missing!**

If no dust protection caps are fitted to unused connections, this may impair the proper functioning of the contacts or destroy them.

- ▶ Remove dust protection caps only when connecting measuring devices or peripherals
- ▶ If you remove a measuring device or peripheral, re-attach the dust protection cap to the connection



The type of connections for encoders may vary depending on the product version.

Rear panel without dust protection caps

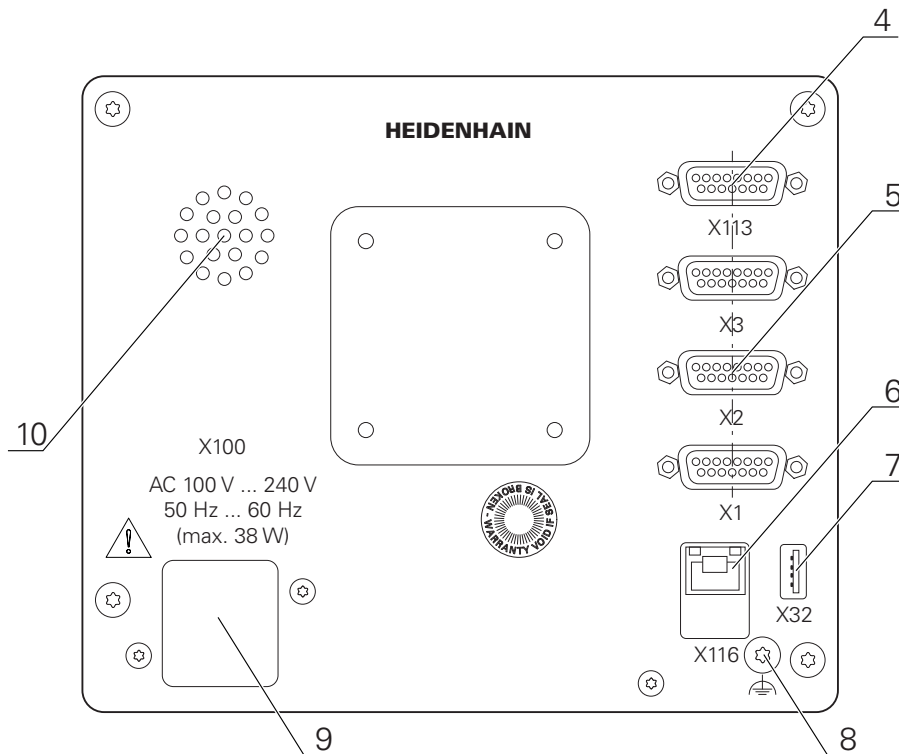

Figure 19: Rear panel on devices with ID 1089181-01

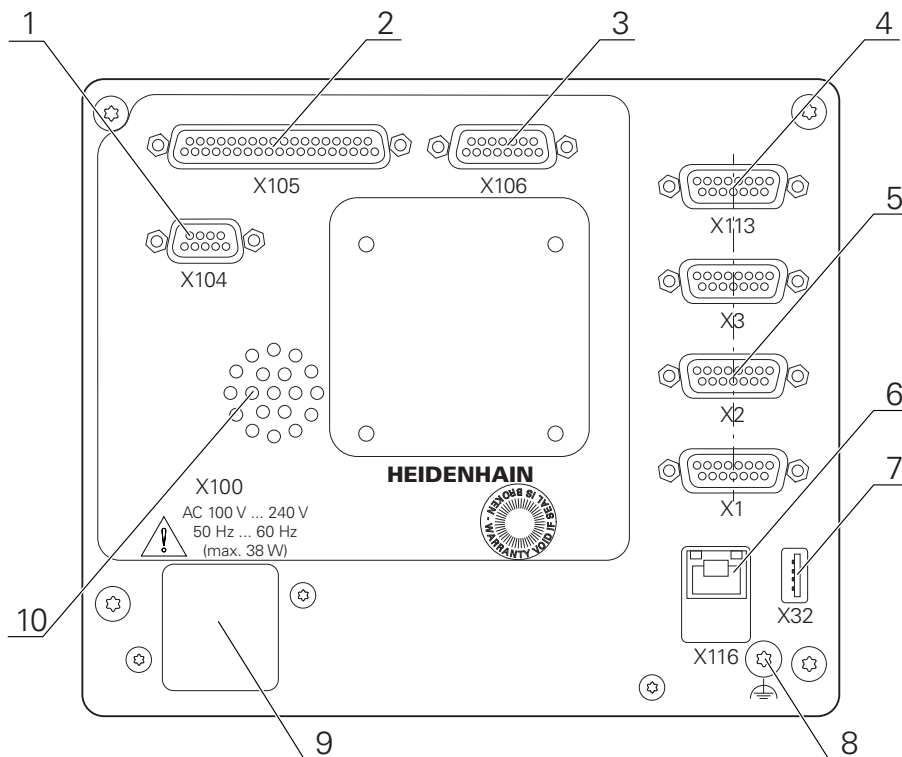

Figure 20: Rear panel on devices with ID 1089182-01

Connections:

- 5 X1 to X3:** device variant with 15-pin D-sub connections for encoders with 1 V_{PP}, 11 μA_{PP} or EnDat 2.2 interface
 - X21 to X23:** Device variant with 9-pin D-sub connections for encoders with a TTL interface
 - X1, X2, X21:** Device variant with two 15-pin D-sub connections for encoders with the 1 V_{PP}, 11μ A_{PP}, or EnDat 2.2 interfaces, and a 9-pin D-sub connection for encoders with a TTL interface
- 7 X32:** USB 2.0 Hi-speed connection (type A) for printers, input devices or USB mass storage
- 10** Speaker
- 8** Functional ground connection as per IEC/EN 60204-1
- 6 X116:** RJ45 Ethernet connection for communication and data exchange with subsequent systems or PC
- 4 X113:** 15-pin D sub connection for touch probes (e.g., HEIDENHAIN touch probe)
- 9 X100:** Power switch and power connection

Additional connections on products with ID 1089182-xx:

- 2 X105:** 37-pin D-sub connection for digital interface (DC 24 V; 24 switching inputs, 8 switching outputs)
- 3 X106:** 15-pin D-sub connection for analog interface (4 inputs, 4 outputs)
- 1 X104:** 9-pin D-sub connection for universal relay interface (2x relay changeover contacts)

3.4 Connecting encoders

i For encoders with an EnDat 2.2 interface: If the corresponding encoder input has already been assigned to an axis in the device settings, then the encoder is automatically detected upon restart, and the settings are adapted. Alternatively, you can assign the encoder input after you have connected the encoder.

- ▶ Comply with the pin layout
- ▶ Remove and save the dust protection cap
- ▶ Route the cables depending on the mounting variant
 - Further information:** "Assembly of the product", Page 57
- ▶ Connect the encoder cables tightly to the respective connections
 - Further information:** "Device overview", Page 64
- ▶ If the cable connectors include mounting screws, do not overtighten them

Pin layout of X1, X2, X3

1 V _{PP} , 11 μA _{PP} , EnDat 2.2								
	1	2	3	4	5	6	7	8
1 V_{PP}	A+	0 V	B+	U _P	/	/	R-	/
11 μA_{PP}	I ₁₊		I ₂₊		/	Internal shield	I ₀₊	/
EnDat	/		/		DATA		/	CLOCK
	9	10	11	12	13	14	15	
1 V_{PP}	A-	Sense 0 V	B-	Sense U _P	/	R+	/	
11 μA_{PP}	I ₁₋		I ₂₋		/	I ₀₊	/	
EnDat	/		/		DATA	/	CLOCK	

Pin layout of X21, X22, X23

TTL								
1	2	3	4	5	6	7	8	9
/	U _{a1}	$\overline{U_{a1}}$	U _{a2}	$\overline{U_{a2}}$	0 V	U _p	$\overline{U_{a0}}$	U _{a0}

3.5 Connecting touch probes

i The following touch probes can be connected to the unit:

- HEIDENHAIN TS 248 touch probe
- HEIDENHAIN KT 130 edge finder
- Renishaw touch trigger probe

Further information: "Items supplied and accessories", Page 51

- ▶ Comply with the pin layout
- ▶ Remove and save the dust protection cap
- ▶ Route the cables depending on the mounting variant
Further information: "Assembly of the product", Page 57
- ▶ Connect the touch probe firmly
Further information: "Device overview", Page 64
- ▶ If the cable connectors include mounting screws, do not overtighten them

Pin layout of X113

1	2	3	4	5	6	7	8
LED+	B 5 V	B 12 V	Dout 0	DC 12 V	DC 5 V	Din 0	GND
9	10	11	12	13	14	15	
Din 1	Din 2	TP	GND	TP	Din 3	LED-	

B – Probe signals, readiness
 TP – Touch Probe, normally closed

Digital inputs:

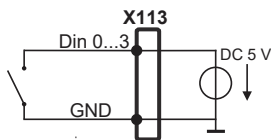

Digital outputs:

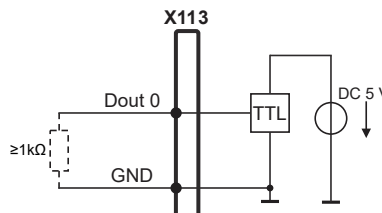

Touch probe:

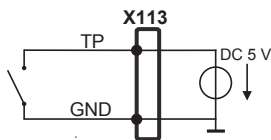

3.6 Wiring switching inputs and outputs

i Depending on the peripherals to be connected, the connection work may need to be carried out by an electrical specialist.
 Example: Safety Extra Low Voltage (SELV) exceeded
Further information: "Personnel qualification", Page 16

i The device fulfills the requirements of standard IEC 61010-1 if power is supplied from a secondary circuit with current limitation as per IEC 61010-13rd Ed., Section 9.4, or from a Class 2 secondary circuit as specified in UL1310.
 In place of IEC 61010-13rd Ed. Section 9.4, the corresponding sections of the standards DIN EN 61010-1, EN 61010-1, UL 61010-1 and CAN/CSA-C22.2 No. 61010-1 can be used as well.

- ▶ Wire switching inputs and outputs in accordance with the following pin layout
 - ▶ Remove and save the dust protection cap
 - ▶ Route the cables depending on the mounting variant
- Further information:** "Assembly of the product", Page 57

- ▶ Connect the connecting cables of the peripherals tightly to their connectors
Further information: "Device overview", Page 64
- ▶ If the cable connectors include mounting screws, do not overtighten them

i The digital or analog inputs and outputs must be assigned in the device settings of the respective switching function.

Pin layout of X104

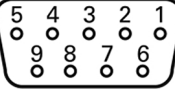
								
1	2	3	4	5	6	7	8	9
R-0 NO	R-0 NC	/	R-1 NO	R-1 NC	R-0 CO	/	/	R-1 CO

CO – Change Over
 NO – Normally Open
 NC – Normally Closed

Relay outputs:

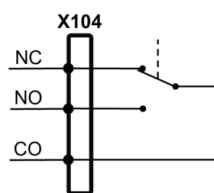

Pin layout of X105

1	2	3	4	5	6	7	8
Din 0	Din 2	Din 4	Din 6	Din 8	Din 10	Din 12	Din 14
9	10	11	12	13	14	15	16
Din 16	Din 18	Din 20	Din 22	Dout 0	Dout 2	Dout 4	Dout 6
17	18	19	20	21	22	23	24
DC 24 V	DC 24 V	GND	Din 1	Din 3	Din 5	Din 7	Din 9
25	26	27	28	29	30	31	32
Din 11	Din 13	Din 15	Din 17	Din 19	Din 21	Din 23	Dout 1
33	34	35	36	37			
Dout 3	Dout 5	Dout 7	DC 24 V	GND			

Digital inputs:

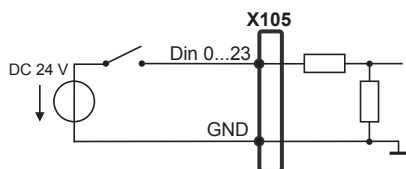

Digital outputs:

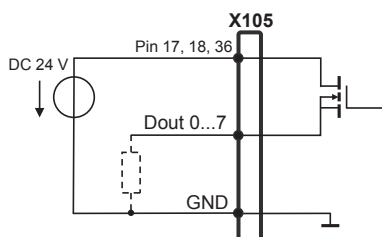

Pin layout of X106

1	2	3	4	5	6	7	8
Aout 0+	Aout 1+	Aout 2+	Aout 3+	GND	GND	Ain 1	Ain 3
9	10	11	12	13	14	15	
Aout 0-	Aout 1-	Aout 2-	Aout 3-	DC 5 V	Ain 0	Ain 2	

Analog inputs:

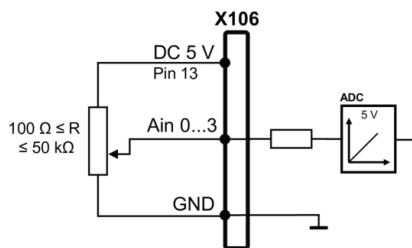

Analog outputs:

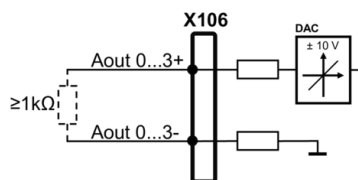

Pin layout of X113

1	2	3	4	5	6	7	8
LED+	B 5 V	B 12 V	Dout 0	DC 12 V	DC 5 V	Din 0	GND
9	10	11	12	13	14	15	
Din 1	Din 2	TP	GND	TP	Din 3	LED-	

B – Probe signals, readiness

TP – Touch Probe, normally closed

Digital inputs:

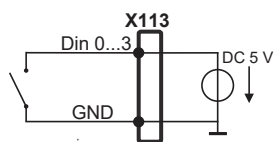

Digital outputs:

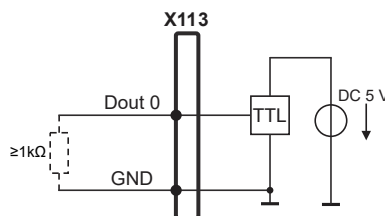

Touch probe:

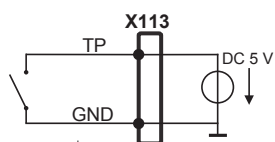

3.7 Connecting input devices

- ▶ Comply with the pin layout
- ▶ Remove and save the dust protection cap
- ▶ Route the cables based on the mounting variant
- ▶ **Further information:** "Assembly of the product", Page 57
- ▶ Connect USB mouse or USB keyboard to USB Type-A port (X32). Make sure the USB cable connector is fully inserted
- ▶ **Further information:** "Device overview", Page 64

Pin layout of X32,

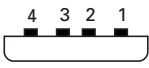
			
1	2	3	4
DC 5 V	Data (-)	Data (+)	GND

3.8 Connecting a network peripheral

- ▶ Comply with the pin layout
- ▶ Remove and save the dust protection cap
- ▶ Route the cables depending on the mounting variant
- ▶ **Further information:** "Assembly of the product", Page 57
- ▶ Connect the network peripheral to Ethernet port X116 using a standard CAT.5 cable. The cable connector must firmly engage in the port
- ▶ **Further information:** "Device overview", Page 64

Pin layout of X116

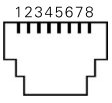
							
1	2	3	4	5	6	7	8
D1+ (TX+)	D1- (TX-)	D2+ (RX+)	D3+	D3-	D2- (RX-)	D4+	D4-

3.9 Connecting the line voltage

⚠ WARNING

Risk of electric shock!

Improper grounding of electrical devices may result in serious personal injury or death by electric shock.

- ▶ Always use 3-wire power cables
- ▶ Make sure the ground wire is correctly connected to the ground of the building's electrical installations

⚠ WARNING

Fire hazard due to wrong power cable!

Use of a power cable that does not meet the requirements of the mounting location may cause a fire hazard.

- ▶ Use only a power cable that meets at least the national requirements of the respective country in which the product is mounted

- ▶ Comply with the pin layout
- ▶ Connect the power connection to a 3-wire grounded power outlet using a power cable that meets requirements

Further information: "Device overview", Page 64

Pin layout X100

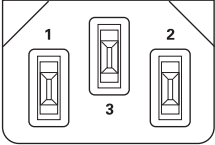
		
1	2	3
L/N	N/L	⊕

4

Commissioning

4.1 Overview

This chapter contains all the information necessary for commissioning the product.

During commissioning, the machine manufacturer's commissioning engineer (**OEM**) configures the product for use on the specific measuring machine.

The settings can be reset to the factory defaults.

Further information: "Reset all settings", Page 184

 Make sure that you have read and understood the "Basic Operation" chapter before carrying out the actions described below.

Further information: "Basic Operation", Page 19

 The following steps must be performed only by qualified personnel.

Further information: "Personnel qualification", Page 16

4.2 Logging in for commissioning

4.2.1 User login

To commission the product, the **OEM** user must log in.



- ▶ Tap **User login** in the main menu
- ▶ If required, log out the user who is currently logged in
- ▶ Select the **OEM** user
- ▶ Tap the **Password** input field
- ▶ Enter the password "**oem**"

 If a password other than the default password has been assigned to the user, ask a **Setup** or **OEM** user for the assigned password.

If the password is no longer known, contact a HEIDENHAIN service agency.



- ▶ Confirm the entry with **RET**
- ▶ Tap **Log in**
- > The user is logged in.
- > The product opens the **Measure** menu

4.2.2 Performing the reference mark search after startup

 If the reference mark search after unit start is active, then all of the unit's functions will be disabled until the reference mark search has been successfully completed.

Further information: "Reference marks (Encoder)", Page 91

 For encoders with EnDat interface, the reference mark search is omitted because the axes are referenced automatically.

If the reference mark search is active on the unit, then a wizard will ask you to traverse the reference marks of the axes.

- ▶ After logging in, follow the instructions of the wizard
- > The Reference symbol stops blinking upon successful completion of the reference mark search.

Further information: "Operating elements of the position display", Page 34

Further information: "Activating the reference mark search", Page 117

4.2.3 Setting the language

The user interface language is English. You can change to another language, if desired.



- ▶ Tap **Settings** in the main menu



- ▶ Tap **User**
 - > The logged-in user is indicated by a check mark.
 - ▶ Select the logged-in user
 - > The language selected for the user is indicated by a national flag in the **Language** drop-down list.
 - ▶ Select the flag for the desired language from the **Language** drop-down list
 - > The user interface is displayed in the selected language.

4.2.4 Changing the password

You must change the password to prevent unauthorized configuration.
The password is confidential and must not be disclosed to any other person.



- ▶ Tap **Settings** in the main menu



- ▶ Tap **User**
 - > The logged-in user is indicated by a check mark.
 - ▶ Select the logged-in user
 - ▶ Tap **Password**
 - ▶ Enter the current password
 - ▶ Confirm entry with **RET**
 - ▶ Enter the new password and repeat it
 - ▶ Confirm entry with **RET**
 - ▶ Tap **OK**
 - ▶ Close the message with **OK**
 - > The new password is available the next time the user logs in.

4.3 Steps for commissioning

 The following commissioning steps build on each other.

- ▶ To correctly commission the product, make sure to perform the steps in the order described here

Prerequisite: You are logged on as a user of the **OEM** type (see "Logging in for commissioning", Page 75).

Basic settings

- Activating Software options
- Setting the date and time
- Setting the units of measure

Configuring a touch probe

- Configuring a touch probe

Configuring the axes

For EnDat interfaces:

- Configuring axes for encoders with EnDat interface
- Performing error compensation
- Ascertaining the line count per revolution

For 1 V_{PP} or 11 μA_{PP} interfaces:

- Activating the reference mark search
- Configuring the axes for encoders with a 1 V_{PP} or 11 μA_{PP} interface
- Performing error compensation
- Ascertaining the line count per revolution

For TTL interface:

- Activating the reference mark search
- Configuring axes for encoders with TTL interface
- Performing error compensation
- Ascertaining the output signals per revolution

-
- Coupling axes

OEM area

- Adding documentation
 - Adding a startup screen
 - Configuring the unit for screenshots
-

Backing up data

- Back up settings
- Back up user files

NOTICE

Loss of or damage to configuration data!

If the product is disconnected from the power source while it is on, the configuration data can be lost or corrupted.

- ▶ Back up the configuration data and keep the backup for recovery purposes

4.4 Basic settings

4.4.1 Activating Software options

You can activate additional **Software options** via a **License key**.



You can view the enabled **Software options** on the overview page.

Further information: "Checking the Software options", Page 80

Requesting license key

You can request a license key by using the following procedure:

- Reading out device information for the license key request
- Creating a license key request

Reading out device information for the license key request



- ▶ Tap **Settings** in the main menu



- ▶ Tap **General**
- ▶ Tap **Device information**
- > An overview of the device information is opened.
- > The product designation, ID number, serial number, and firmware version are displayed.
- ▶ Contact a HEIDENHAIN service agency and submit the displayed device information in order to request a license key for the product
- > The license key and the license file are generated and submitted by e-mail

Creating a license key request



- ▶ Tap **Settings** in the main menu



- ▶ Tap **Service**
- ▶ Tap **Software options**
- ▶ To request a software option that is available for a fee, tap **Request options**
- ▶ To request a free trial option, tap **Request trial options**
- ▶ To select the desired software option, tap its check mark



- ▶ To deselect an entry, tap the check mark for the respective software option

- ▶ Tap **Creating a request**
- ▶ In the dialog box, select the storage location in which you want to save the license key request
- ▶ Enter a suitable file name
- ▶ Confirm your input with **RET**
- ▶ Tap **Save as**
- > The license key request is created and saved in the selected folder.
- ▶ If the license key request is stored on the product, move the file to a connected USB mass storage device (FAT32 format) or the network drive
Further information: "Managing folders and files", Page 153
- ▶ Contact a HEIDENHAIN service agency and submit the file you created in order to request a license key
- > The license key and the license file are generated and submitted by e-mail

Activating a license key

You can activate a license key by

- Reading the license key from the provided license file into the product
- Entering the license key manually into the product

Uploading license key from license file



- ▶ Tap **Settings** in the main menu



- ▶ Tap **Service**
- ▶ Open in succession:
 - **Software options**
 - **Activate options**
- ▶ Tap **Read license file**
- ▶ Select the license file in the file system, on the USB mass storage device or on the network drive
- ▶ Confirm your selection with **Select**
- ▶ Tap **OK**
- > The license key is activated.
- ▶ Tap **OK**
- > You may need to restart the product, depending on the software option.
- ▶ Confirm the restart with **OK**
- > The activated software option is available.

Entering license key manually



- ▶ Tap **Settings** in the main menu



- ▶ Tap **Service**
- ▶ Open in succession:
 - **Software options**
 - **Activate options**
- ▶ Enter the license key into the **License key** input field
- ▶ Confirm the entry with **RET**
- ▶ Tap **OK**
- > The license key is activated.
- ▶ Tap **OK**
- > You may need to restart the product, depending on the software option.
- ▶ Confirm the restart with **OK**
- > The activated software option is available.

Checking the Software options

On the overview page, you can check which **Software options** are enabled for the product.



- ▶ Tap **Settings** in the main menu



- ▶ Tap **Service**
- ▶ Open in succession:
 - **Software options**
 - **Overview**
- > A list of enabled **Software options** is displayed.

4.4.2 Setting the date and time

Settings ► General ► Date and time

Parameter	Explanation
Date and time	Current date and time of the product <ul style="list-style-type: none"> Settings: Year, Month, Day, Hour, Minute Default setting: Current system time
Date format	Format in which the date is displayed Settings: <ul style="list-style-type: none"> MM-DD-YYYY: Month, day, year DD-MM-YYYY: Day, month, year YYYY-MM-DD: Year, month, day Default setting: YYYY-MM-DD (e.g. "2016-01-31")

4.4.3 Setting the units of measure

You can set various parameters to define the units of measure, rounding methods and decimal places.

Settings ► General ► Units

Parameter	Explanation
Unit for linear values	Unit of measure for linear values <ul style="list-style-type: none"> Settings: Millimeters or Inch Default setting: Millimeters
Rounding method for linear values	Rounding method for linear values Settings: <ul style="list-style-type: none"> Commercial: Decimal places from 1 to 4 are rounded down, decimal places from 5 to 9 are rounded up Round off: Decimal places from 1 to 9 are rounded down Round up: Decimal places from 1 to 9 are rounded up Truncate: Decimal places are truncated without rounding up or down Round to 0 and 5: Decimal places ≤ 24 or ≥ 75 are rounded to 0, decimal places ≥ 25 or ≤ 74 are rounded to 5 Default setting: Commercial
Decimal places for linear values	Number of decimal places for linear values Setting range: <ul style="list-style-type: none"> Millimeters: 0 ... 5 Inch: 0 ... 7 Default value: <ul style="list-style-type: none"> Millimeters: 4 Inch: 6
Unit for angular values	Unit for angular values Settings: <ul style="list-style-type: none"> Radian: Angles in radian (rad) Decimal degrees: Angles in degrees ($^{\circ}$) with decimal places Deg-Min-Sec: Angles in degrees ($^{\circ}$), minutes [$'$] and seconds [$''$] Default setting: Decimal degrees

Parameter	Explanation
Rounding method for angular values	<p>Rounding method for decimal angular values</p> <p>Settings:</p> <ul style="list-style-type: none"> ■ Commercial: Decimal places from 1 to 4 are rounded down, decimal places from 5 to 9 are rounded up ■ Round off: Decimal places from 1 to 9 are rounded down ■ Round up: Decimal places from 1 to 9 are rounded up ■ Truncate: Decimal places are truncated without rounding up or down ■ Round to 0 and 5: Decimal places ≤ 24 or ≥ 75 are rounded to 0, decimal places ≥ 25 or ≤ 74 are rounded to 5 ■ Default setting: Commercial
Decimal places for angular values	<p>Number of decimal places for angular values</p> <p>Setting range:</p> <ul style="list-style-type: none"> ■ Radian: 0 ... 7 ■ Decimal degrees: 0 ... 5 ■ Deg-Min-Sec: 0 ... 2 <p>Default value:</p> <ul style="list-style-type: none"> ■ Radian: 5 ■ Decimal degrees: 3 ■ Deg-Min-Sec: 0
Decimal separator	<p>Separator for the display of values</p> <ul style="list-style-type: none"> ■ Settings: Point or Comma ■ Default setting: Point

4.5 Configuring a touch probe

You can use a touch probe to probe points. The stylus of the touch probe can be additionally fitted with a ruby ball tip. In order to use a touch probe, you need to configure the relevant parameters.

Settings ► Sensors ► Touch probe

Parameter	Explanation
Touch probe	<p>Activates or deactivates the connected touch probe for use</p> <ul style="list-style-type: none"> ■ Setting range: ON or OFF ■ Default value: OFF
Diameter	<p>Diameter of the touch probe</p> <ul style="list-style-type: none"> ■ Setting range: \geq 0.0001 ■ Default value: 6.0000
Evaluation of the ready signal	<p>Possibility of setting whether the ready signal of the touch probe should be evaluated, depending on the touch probe</p> <ul style="list-style-type: none"> ■ Setting range: ON or OFF ■ Default value: ON



Use the touch-probe triggered output of measured values to automatically send the measured values to a computer when the stylus is deflected.

Further information: "Configuring the measured value output", Page 242

4.6 Configuring the axes

The procedure varies depending on the interface type of the connected encoder:

- Encoders with EnDat interface:
The encoder applies the parameters automatically
Further information: "Configuring axes for encoders with EnDat interface", Page 87
- Encoders with 1 V_{pp} or 11 μA_{pp} or TTL interface:
The parameters must be configured manually

For the parameters of HEIDENHAIN encoders that are typically connected to the product, refer to the overview of typical encoders.

Further information: "Overview of typical encoders", Page 84

4.6.1 Configuring Alias assignment for axis names

Depending on your application, you can assign axis names yourself. The axis name is a two-digit numerical value, a two-character combination of letters, or a two-character combination of a numerical value and a letter.

Settings ► Axes ► General settings ► Alias assignment for axis names

Parameter	Explanation
C1	■ Setting range: 00 ... 99 and aA ... xX
C2	■ Default value: X (for C1)
C3	■ Default value: Y (for C2) ■ Default value: Z (for C3)

- ▶ Enter a name in the input fields
- > The names are available in the axis configuration. They can be assigned to the respective encoder input

4.6.2 Overview of typical encoders

The following overview lists the parameters of the HEIDENHAIN encoders that are typically connected to the product.



When connecting other encoders, refer to the encoder's documentation for the required parameters.

Linear encoders

Encoder series	Interface	Signal period	Reference mark	Maximum traverse path
AK LIDA 27	TTL	20 μm	One	-
		4 μm		
		2 μm		
AK LIDA 47	TTL	4 μm	One	-
		4 μm	Coded / 1000*)	20 mm
		2 μm	One	-
		2 μm	Coded / 1000*)	20 mm
LS 388C	1 V_{PP}	20 μm	Coded / 1000	20 mm
AK LIDA 28	1 V_{PP}	200 μm	One	-
AK LIDA 48	1 V_{PP}	20 μm	One	-
AK LIF 48	1 V_{PP}	4 μm	One	-

*) "Coded / 1000" only in conjunction with the LIDA 4x3C scale

Examples of absolute encoders that are typically used

Encoder series	Interface	Measuring step
AK LIC 411	EnDat 2.2	1 nm
		5 nm
		10 nm
LIC 211 scanning head	EnDat 2.2	50 nm
		100 nm
LIC 311 scanning head	EnDat 2.2	10 nm

Length gauges

Length gauge series	Interface	Signal period	Reference mark	Maximum traverse path
CT 250x	11 μA_{PP}	2 μm	One	25 mm
CT 600x	11 μA_{PP}	2 μm	One	60 mm
MT 1271	TTL	0.4 μm , 0.2 μm *)	One	12 mm
MT 128x	1 V_{PP}	2 μm	One	12 mm
MT 2571	TTL	0.4 μm , 0.2 μm *)	One	25 mm
MT 258x	1 V_{PP}	2 μm	One	25 mm
MT 60x	11 μA_{PP}	10 μm	One	60 mm
MT 101x	11 μA_{PP}	10 μm	One	100 mm
ST 127x	TTL	4 μm , 2 μm *)	One	12 mm
ST 128x	1 V_{PP}	20 μm	One	12 mm
ST 307x	TTL	4 μm , 2 μm *)	One	30 mm
ST 308x	1 V_{PP}	20 μm	One	30 mm

*) 0.2 μm or 2 μm with 10-fold evaluation
 0.4 μm or 4 μm with 5-fold evaluation

Length gauge series	Interface	Measuring step	Maximum traverse path
AT 121x	EnDat 2.2	23 nm	12 mm
AT 301x	EnDat 2.2	368 nm	30 mm

Angle encoders

Encoder series	Interface	Line count/ outputs signals per revolution	Reference mark	Nominal increment
RON 275	TTLx10	18000	One	-
RON 285	1 V _{PP}	18000	One	-
RON 285C	1 V _{PP}	18000	Coded	20°
RON 785	1 V _{PP}	18000	One	-
RON 785C	1 V _{PP}	18000	Coded	20°
RON 786	1 V _{PP}	18000	One	-
RON 786C	1 V _{PP}	18000	Coded	20°
ROD 280	1 V _{PP}	18000	One	-
ROD 280C	1 V _{PP}	18000	Coded	20°



The formulae below enable you to calculate the nominal increment of the distance-coded reference marks with angle encoders:

Nominal increment = $360^\circ \div \text{number of reference marks} \times 2$

Nominal increment = $(360^\circ \times \text{nominal increment in signal periods}) \div \text{line count}$

4.6.3 Configuring axes for encoders with EnDat interface

If the corresponding encoder input has already been assigned to an axis, a connected encoder with EnDat interface is automatically detected upon restart, and the settings are adapted. Alternatively, you can assign the encoder input after you have connected the encoder.

Prerequisite: An encoder with EnDat interface is connected to the product.

Settings ► **Axes** ► **<Axis name>** ► **Encoder**

Parameter	Explanation
Encoder input	Assignment of the encoder input to the axis of the product Settings: <ul style="list-style-type: none"> ■ Not connected ■ X1 ■ X2 ■ X3 Further information: "Device overview", Page 64
Interface	Automatically detected EnDat interface type
ID label	Information on the encoder that was read from the electronic ID label
Diagnosis	Results of encoder diagnostics, evaluation of encoder function (e.g., based on functional reserves) Further information: "Diagnostics for encoders with EnDat interface", Page 178
Encoder model	Connected encoder model Settings: <ul style="list-style-type: none"> ■ Linear encoder: Linear axis ■ Angle encoder: Rotary axis ■ Angle encoder as linear encoder: Rotary axis is displayed as linear axis ■ Default value: Depending on the connected encoder
Mechanical ratio	For display of a rotary axis as a linear axis: traverse path in mm per revolution <ul style="list-style-type: none"> ■ Setting range: 0.1 mm ... 1000 mm ■ Default value: 1.0
Reference point displacement	Configuration of the offset between the reference mark and the zero point Further information: "Reference point displacement", Page 88

Using an Angle encoder as linear encoder

Certain parameters must be taken into account when configuring an angle encoder or rotary encoder as a linear encoder, in order to prevent an overrun of the system.

- The mechanical ratio must be chosen such that the maximum traverse range of 21474.483 mm is not exceeded
- The reference mark shift should only be used when considering the maximum traverse range of ± 21474.483 mm, since this limit applies both with and without a reference mark shift
- **Only for multiturn rotary encoders with EnDat 2.2:** the rotary encoder must be mounted such that an overrun of the rotary encoder does not affect the machine coordinates negatively

Reference point displacement

Settings ► Axes ► <Axis name> ► Encoder ► Reference marks ► Reference point displacement

Parameter	Explanation
Reference point displacement	Activation of offset calculation between reference mark and zero point of the machine <ul style="list-style-type: none"> ■ Setting range: ON or OFF ■ Default value: OFF
Reference point displacement	Manual input of the offset (in mm or degrees according to the selected encoder type) between reference mark and zero point Default value: 0.00000
Current position for reference point shift	Apply applies the current position as an offset (in mm or degrees, depending on the selected encoder model) between the reference mark and the zero point

4.6.4 Configuring the axes for encoders with a 1 V_{pp} or 11 μA_{pp} interface

Settings ► Axes ► <Axis name> ► Encoder

Parameter	Explanation
Encoder input	Assignment of the encoder input to the axis of the product Settings: <ul style="list-style-type: none"> ■ Not connected ■ X1 ■ X2 ■ X3 Further information: "Device overview", Page 64
Incremental signal	Signal of the connected encoder Settings: <ul style="list-style-type: none"> ■ 1 V_{pp}: Sinusoidal voltage signal ■ 11 μA_{pp}: Sinusoidal current signal ■ Default value: 1 V_{pp}
Encoder model	Connected encoder model Settings: <ul style="list-style-type: none"> ■ Linear encoder: Linear axis ■ Angle encoder: Rotary axis ■ Angle encoder as linear encoder: Rotary axis is displayed as linear axis ■ Default value: Depending on the connected encoder
Signal period	For linear encoders Length of a signal period <ul style="list-style-type: none"> ■ Setting range: 0.001 μm ... 1000000.000 μm ■ Default value: 20.000
Line count	For angle encoders and for display of a rotary axis as a linear axis. Number of lines <ul style="list-style-type: none"> ■ Setting range: 1 ... 1000000 ■ Default value: 1000

Parameter	Explanation
Teach sequence	Starts the teach sequence for determining the Line count for an angle encoder based on a specified angle of rotation.
Display mode	For angle encoders and for the display of a rotary axis as a linear axis. Settings: <ul style="list-style-type: none"> ■ $-\infty \dots \infty$ ■ $0^\circ \dots 360^\circ$ ■ $-180^\circ \dots 180^\circ$ ■ Default value: $-\infty \dots \infty$
Mechanical ratio	For display of a rotary axis as a linear axis: traverse path in mm per revolution <ul style="list-style-type: none"> ■ Setting range: 0.1 mm ... 1000 mm ■ Default value: 1.0
Reference marks	Configuration of the Reference marks Further information: "Reference marks (Encoder)", Page 91
Analog filter frequency	Frequency value of the analog low-pass filter Settings: <ul style="list-style-type: none"> ■ 33 kHz: Suppression of interference frequencies above 33 kHz ■ 400 kHz: Suppression of interference frequencies above 400 kHz ■ Default value: 400 kHz
Terminating resistor	Dummy load to avoid reflections <ul style="list-style-type: none"> ■ Settings: ON or OFF ■ Default value: ON <div style="border: 1px solid black; padding: 5px; margin-top: 10px;">  The terminating resistor is automatically deactivated for incremental signals of the current signal type (11 μA_{PP}) </div>

Parameter	Explanation
Error monitor	<p>Monitoring of signal errors</p> <p>Settings:</p> <ul style="list-style-type: none"> ■ Off: Error monitoring not active ■ Amplitude: Error monitoring of the signal amplitude ■ Frequency: Error monitoring of the signal frequency ■ Frequency & amplitude: Error monitoring of the signal amplitude and signal frequency ■ Default value: Frequency & amplitude <div style="border: 1px solid black; padding: 5px; margin-top: 10px;"> <p> A warning or error message is displayed if one of the limit values for error monitoring is exceeded.</p> </div> <p>The limit values depend on the signal of the connected encoder:</p> <ul style="list-style-type: none"> ■ Signal 1 Vpp, setting Amplitude <ul style="list-style-type: none"> ■ Warning with voltage ≤ 0.45 V ■ Error message with voltage ≤ 0.18 V or ≥ 1.34 V ■ Signal 1 Vpp, setting Frequency <ul style="list-style-type: none"> ■ Error message with frequency ≥ 400 kHz ■ Signal 11 μApp, setting Amplitude <ul style="list-style-type: none"> ■ Warning with current ≤ 5.76 μA ■ Error message with current ≤ 2.32 μA or ≥ 17.27 μA ■ Signal 11 μApp, setting Frequency <ul style="list-style-type: none"> ■ Error message with frequency ≥ 150 kHz
Counting direction	<p>Signal detection during axis movement</p> <p>Settings:</p> <ul style="list-style-type: none"> ■ Positive: The direction of traverse corresponds to the counting direction of the encoder ■ Negative: The direction of traverse does not correspond to the counting direction of the encoder ■ Default value: Positive
Diagnosis	<p>Results of encoder diagnostics, evaluation of encoder function (e.g., based on Lissajous figure)</p> <p>Further information: "Diagnostics for encoders with 1 V_{pp}/11 μA_{pp} interface", Page 177</p>

Ascertaining the line count per revolution

For angle encoders with interfaces of the type 1 V_{PP} or 11 μA_{PP} you can use a teach sequence to ascertain the exact line count per revolution.

Settings ▶ Axes ▶ <Axis name> ▶ Encoder



- ▶ From the **Encoder model** drop-down list, select **Angle encoder**
- ▶ For **Display mode**, select the option **-∞ ... ∞**
- ▶ Tap **Reference marks**
- ▶ Select one of the following options from the **Reference mark** drop-down list:
 - **None**: There is no reference mark
 - **One**: The encoder has one reference mark
- ▶ In order to switch to the previous axis, tap **Back**
- ▶ To start the teach sequence, tap **Start**
- ▶ The teach sequence is started and the Wizard opens.
- ▶ Follow the instructions of the wizard
- ▶ The line count determined during the teach sequence is transferred to the **Line count** field.

 The ascertained line count remains stored if you select a different display mode after the teach sequence.

Reference marks (Encoder)

Settings ▶ Axes ▶ <Axis name> ▶ Encoder ▶ Reference marks

 For encoders with EnDat interface, the reference mark search is omitted because the axes are referenced automatically.

Parameters	Explanation
Reference mark	Definition of the type of reference mark Settings: <ul style="list-style-type: none"> ■ None: There is no reference mark ■ One: The encoder has one reference mark ■ Coded: The encoder has distance-coded reference marks For encoders with TTL interface: <ul style="list-style-type: none"> ■ Reverse coded: The encoder has inverse-coded reference marks ■ Default value: One
Maximum traverse path	For linear encoders with coded reference marks: maximum traverse path for determining the absolute position <ul style="list-style-type: none"> ■ Setting range: 0.1 mm ... 10000.0 mm ■ Default value: 20.0
Nominal increment	For angle encoders with coded reference marks: maximum nominal increment for determining the absolute position <ul style="list-style-type: none"> ■ Setting range: > 0° ... 360° ■ Default value: 10.0

Parameters	Explanation
Interpolation	For encoders with TTL interface: Interpolation value of the encoders and integrated interpolation for the evaluation of the coded reference marks. Settings: <ul style="list-style-type: none"> ■ None ■ 2-fold ■ 5-fold ■ 10-fold ■ 20-fold ■ 50-fold ■ Default value: None
Inversion of reference mark pulses	Specifies whether the reference mark pulses are evaluated in inverted form Settings <ul style="list-style-type: none"> ■ ON: Reference pulses are evaluated in inverted form ■ OFF: Reference pulses are not evaluated in inverted form ■ Default value: OFF
Reference point displacement	Configuration of the offset between the reference mark and the zero point Further information: "Reference point displacement", Page 88

Reference point displacement

Settings ► Axes ► <Axis name> ► Encoder ► Reference marks ► Reference point displacement

Parameter	Explanation
Reference point displacement	Activation of offset calculation between reference mark and zero point of the machine <ul style="list-style-type: none"> ■ Setting range: ON or OFF ■ Default value: OFF
Reference point displacement	Manual input of the offset (in mm or degrees according to the selected encoder type) between reference mark and zero point Default value: 0.00000
Current position for reference point shift	Apply applies the current position as an offset (in mm or degrees, depending on the selected encoder model) between the reference mark and the zero point

4.6.5 Configuring axes for encoders with TTL interface

Settings ► Axes ► <Axis name> ► Encoder

Parameter	Explanation
Encoder input	Assignment of the encoder input to the axis of the product Settings: <ul style="list-style-type: none"> ■ X21 ■ X22 ■ X23 Further information: "Device overview", Page 64
Interface	Automatically detected TTL interface type
Encoder model	Connected encoder model Settings: <ul style="list-style-type: none"> ■ Linear encoder: Linear axis ■ Angle encoder: Rotary axis ■ Angle encoder as linear encoder: Rotary axis is displayed as linear axis ■ Default value: Depending on the connected encoder
Signal period	For linear encoders Length of a signal period The signal period must be calculated: <i>Interval or grating period / Interpolation = Signal period</i> <ul style="list-style-type: none"> ■ Setting range: 0.001 µm ... 1000000.000 µm ■ Default value: 20.000
Output signals per revolution	For angle encoders and for display of a rotary axis as a linear axis Number of output signals <ul style="list-style-type: none"> ■ Setting range: 1 ... 10000000 ■ Default value: 18000
Teach sequence	Starts the teach sequence for determining the Output signals per revolution for an angle encoder based on a specified angle of rotation.
Display mode	For angle encoders and for the display of a rotary axis as a linear axis. Settings: <ul style="list-style-type: none"> ■ -∞ ... ∞ ■ 0° ... 360° ■ -180° ... 180° ■ Default value: -∞ ... ∞
Mechanical ratio	For display of a rotary axis as a linear axis: traverse path in mm per revolution <ul style="list-style-type: none"> ■ Setting range: 0.1 mm ... 1000 mm ■ Default value: 1.0
Reference marks	Configuration of the Reference marks Further information: "Reference marks (Encoder)", Page 91
Terminating resistor	Dummy load to avoid reflections <ul style="list-style-type: none"> ■ Settings: ON or OFF ■ Default value: ON

Parameter	Explanation
Error monitor	<p>Monitoring of signal errors</p> <p>Settings:</p> <ul style="list-style-type: none"> ■ Off: Error monitoring not active ■ Frequency: Error monitoring of the signal frequency ■ Default value: Frequency <div style="border: 1px solid black; padding: 5px; margin: 10px 0;"> <p> A warning or error message is displayed if one of the limit values for error monitoring is exceeded.</p> </div> <p>The limit values depend on the signal of the connected encoder:</p> <ul style="list-style-type: none"> ■ Error message with frequency ≥ 5 MHz
Counting direction	<p>Signal detection during axis movement</p> <p>Settings:</p> <ul style="list-style-type: none"> ■ Positive: The direction of traverse corresponds to the counting direction of the encoder ■ Negative: The direction of traverse does not correspond to the counting direction of the encoder ■ Default value: Positive

Ascertaining the output signals per revolution

For angle encoders with interfaces of the type TTL you can use a teach sequence to ascertain the exact quantity of output signals per revolution.

Settings ► Axes ► <Axis name> ► Encoder

- ▶ From the **Encoder model** drop-down list, select **Angle encoder**
- ▶ For **Display mode**, select the option $-\infty \dots \infty$
- ▶ Tap **Reference marks**
- ▶ Select one of the following options from the **Reference mark** drop-down list:
 - **None**: There is no reference mark
 - **One**: The encoder has one reference mark
- ▶ In order to switch to the previous axis, tap **Back**
- ▶ To start the teach sequence, tap **Start**
- > The teach sequence is started and the Wizard opens.
- ▶ Follow the instructions of the wizard
- > The number of output signals determined during the teach sequence is transferred to the **Output signals per revolution** field.



 The ascertained quantity of output signals remains stored if you select a different display mode after the teach sequence.

Reference marks (Encoder)

Settings ► Axes ► <Axis name> ► Encoder ► Reference marks



For encoders with EnDat interface, the reference mark search is omitted because the axes are referenced automatically.

Parameters	Explanation
Reference mark	<p>Definition of the type of reference mark</p> <p>Settings:</p> <ul style="list-style-type: none"> ■ None: There is no reference mark ■ One: The encoder has one reference mark ■ Coded: The encoder has distance-coded reference marks <p>For encoders with TTL interface:</p> <ul style="list-style-type: none"> ■ Reverse coded: The encoder has inverse-coded reference marks ■ Default value: One
Maximum traverse path	<p>For linear encoders with coded reference marks: maximum traverse path for determining the absolute position</p> <ul style="list-style-type: none"> ■ Setting range: 0.1 mm ... 10000.0 mm ■ Default value: 20.0
Nominal increment	<p>For angle encoders with coded reference marks: maximum nominal increment for determining the absolute position</p> <ul style="list-style-type: none"> ■ Setting range: > 0° ... 360° ■ Default value: 10.0
Interpolation	<p>For encoders with TTL interface:</p> <p>Interpolation value of the encoders and integrated interpolation for the evaluation of the coded reference marks.</p> <p>Settings:</p> <ul style="list-style-type: none"> ■ None ■ 2-fold ■ 5-fold ■ 10-fold ■ 20-fold ■ 50-fold ■ Default value: None
Inversion of reference mark pulses	<p>Specifies whether the reference mark pulses are evaluated in inverted form</p> <p>Settings</p> <ul style="list-style-type: none"> ■ ON: Reference pulses are evaluated in inverted form ■ OFF: Reference pulses are not evaluated in inverted form ■ Default value: OFF
Reference point displacement	<p>Configuration of the offset between the reference mark and the zero point</p> <p>Further information: "Reference point displacement", Page 88</p>

Reference point displacement

Settings ► Axes ► <Axis name> ► Encoder ► Reference marks ►
Reference point displacement

Parameter	Explanation
Reference point displacement	Activation of offset calculation between reference mark and zero point of the machine <ul style="list-style-type: none"> ■ Setting range: ON or OFF ■ Default value: OFF
Reference point displacement	Manual input of the offset (in mm or degrees according to the selected encoder type) between reference mark and zero point Default value: 0.00000
Current position for reference point shift	Apply applies the current position as an offset (in mm or degrees, depending on the selected encoder model) between the reference mark and the zero point

4.6.6 Performing error compensation

Mechanical influences such as guideway error, tilting in the end positions, mounting surface tolerances, or poor mounting (Abbe error) can cause measuring errors. With error compensation, the unit can automatically compensate for systematic measuring errors during measuring point acquisition. Through the comparison of nominal and actual values, one or more compensation factors can be defined and applied during subsequent measurements.

A distinction is made between the following methods:

Configuring error compensation for individual axes

- Linear error compensation (LEC): The compensation factor is calculated based on the specified length of a calibration standard (nominal length) and the actual distance traversed (actual length). The compensation factor is applied linearly to the entire measuring range.
- Segmented linear error compensation (SLEC): The axis is divided into multiple segments with the help of a maximum of 200 supporting points. A distinct compensation factor is defined and applied for every segment.

Configuring error compensation across axes

- Nonlinear error compensation (NLEC): By means of a maximum of a 99 supporting points, the measuring range is divided into a grid with multiple subareas. For every subarea, a distinct compensation factor is determined and applied.
- Squareness error compensation: The compensation factor is determined by comparing the nominal angle of the spatial axes with the measurement result. The compensation factor is applied to the entire measuring range.

NOTICE

Subsequent modifications to the encoder settings can result in measuring errors

If encoder settings such as the encoder input, encoder model, signal period, or reference marks are changed, previously determined compensation factors may no longer apply.

- ▶ If you change encoder settings, then you need to reconfigure the error compensation

i For all methods, the actual error curve must be exactly measured (e.g., with the help of a comparator measuring device or calibration standard).

i Linear error compensation and segmented linear error compensation cannot be combined with each other.

i If you enable a reference point shift, then you need to reconfigure the error compensation. This helps you avoid measuring errors.

Settings ► Axes ► General settings ► Error compensation

Parameter	Explanation
Nonlinear error compensation (NLEC)	Mechanical influences on the X and Y axes are compensated
Squareness error compensation (SEC)	Mechanical influences on the squareness of the X , Y and Z axes relative to each other are compensated

Configuring linear error compensation (LEC)

With linear error compensation (LEC), the product applies a compensation factor that is calculated from the specified length or angle of a reference standard (nominal length or nominal angle) and the actual traverse path (actual length and actual angle). The compensation factor is applied to the entire measuring range.

Settings ► Axes ► <Axis name> ► Error compensation ► Linear error compensation (LEC)

Parameter	Explanation
Compensation	Mechanical influences on the axes of the machine are compensated Settings: <ul style="list-style-type: none"> ■ ON: Compensation is active ■ OFF: Compensation is not active ■ Default value: OFF

 If **Compensation** is active, the **Nominal length** and **Actual length** cannot be edited or generated.

Nominal length	Input field for the length of the calibration standard according to the manufacturer's specifications Input: Millimeters or degrees (depending on the encoder)
Actual length	Input field for entering the measured length (actual distance traversed) Input: millimeters or degrees (depending on the encoder)

Configuring segmented linear error compensation (SLEC)

For a segmented linear error compensation (SLEC), you divide the axis into short segments by defining up to 200 supporting points. The deviations between the actual distance traversed and the segment length in the individual segments determine the compensation values that compensate the mechanical influences acting on the axis.

i If the $-\infty \dots \infty$ display mode is selected for the angle encoder, the error compensation of angle encoders does not affect negative values of the supporting points.

Settings ► Axes ► <Axis name> ► Error compensation ►
Segmented linear error compensation (SLEC)

Parameter	Explanation
Compensation	<p>Mechanical influences on the axes of the machine are compensated</p> <p>Settings:</p> <ul style="list-style-type: none"> ■ ON: Compensation is active ■ OFF: Compensation is not active ■ Default value: OFF
	<p>i When Compensation is active, then the Table of supporting points cannot be edited or created.</p>
Table of supporting points	<p>Opens the table of supporting points for manual editing</p> <p>The table shows the following for the respective segments:</p> <ul style="list-style-type: none"> ■ Supporting point positions (P) ■ Compensation values (D)
Create table of supporting points	<p>Opens the menu for creating a new Table of supporting points</p> <p>Further information: "Create table of supporting points", Page 100</p>

Create table of supporting points

**Settings ▶ Axes ▶ <Axis name> ▶ Error compensation ▶
Segmented linear error compensation (SLEC) ▶ Create table of supporting points**

Parameters	Explanation
Number of supporting points	Number of supporting points on the mechanical axis of the machine <ul style="list-style-type: none"> ■ Setting range: 2 ... 200 ■ Default value: 2
Spacing of the supporting points	Spacing of the supporting points on the mechanical axis of the machine <ul style="list-style-type: none"> ■ Default value: 100.00000
Start point	The start point defines the position starting from which the compensation is applied to the axis <ul style="list-style-type: none"> ■ Default value: 0.00000
Create	Creates a new table of supporting points based on the entries

- ▶ Enter the compensation value (D) "**0.0**" for supporting point **0**
- ▶ Enter the measured compensation values into the **compensation value (D)** input field for each supporting point created
- ▶ Confirm the entries with **RET**

Create table of supporting points

**Settings ▶ Axes ▶ <Axis name> ▶ Error compensation ▶
Segmented linear error compensation (SLEC) ▶ Create table of supporting points**

Parameters	Explanation
Number of supporting points	Number of supporting points on the mechanical axis of the machine <ul style="list-style-type: none"> ■ Setting range: 2 ... 200 ■ Default value: 2
Spacing of the supporting points	Spacing of the supporting points on the mechanical axis of the machine <ul style="list-style-type: none"> ■ Default value: 100.00000
Start point	The start point defines the position starting from which the compensation is applied to the axis <ul style="list-style-type: none"> ■ Default value: 0.00000
Create	Creates a new table of supporting points based on the entries

Adjusting an existing table of supporting points

After a table of supporting points for segmented linear error compensation has been created, this table can then be modified as needed.

Settings ► Axes ► <Axis name> ► Error compensation ► Segmented linear error compensation (SLEC)



- ▶ Use the **ON/OFF** slide switch to deactivate the **Compensation** function
- ▶ Tap **Table of supporting points**
- ▶ The table lists the **supporting point positions (P)** and the **compensation values (D)** of the individual segments.
- ▶ Adjust the **compensation value (D)** for the supporting points
- ▶ Confirm the entries with **RET**
- ▶ To switch to the previous display, tap **Back**
- ▶ Activate **Compensation** with the **ON/OFF** slide switch
- ▶ The adjusted error compensation for the axis is applied.

Further information: "Configuring segmented linear error compensation (SLEC)", Page 99

Configuring the Nonlinear error compensation (NLEC)

Nonlinear error compensation (NLEC)

For a **Nonlinear error compensation (NLEC)** the measuring range is divided into a grid of identically sized surface segments using up to 99 supporting points. For each of the surface segments, a specific compensation factor is determined by comparing nominal and actual values (the measured values) at the supporting points.

The following options are available for measuring the nominal and actual values of the supporting points:

Acquiring nominal values

- Read deviations from the calibration standard (ACF)
- Create a table of supporting points manually

Acquiring actual values

- Import the table of supporting points (TXT or XML)
- Determine the actual values using a teach sequence
- Acquire the actual values manually



The following specifications apply to import files:

- ▶ File names must not contain diacritics or special characters
- ▶ Use a point as decimal character



In the following situations, both nominal and actual values in the existing table of supporting points will be overwritten:

- If you change the number or spacing of the supporting points manually
- If you import a file that contains deviating information on the number or spacing of the supporting points

Parameter	Explanation
Compensation	Mechanical influences on the axes of the machine are compensated Settings: <ul style="list-style-type: none"> ■ ON: Compensation is active ■ OFF: Compensation is not active ■ Default value: OFF
Number of supporting points	Number of measuring points for error compensation on both axes (X and Y) of the encoder <ul style="list-style-type: none"> ■ Setting range: 1 ... 99 (X and Y) ■ Default value: 2 (X and Y)
Spacing of the supporting points	Spacing of the compensation points on the axes (X and Y) <ul style="list-style-type: none"> ■ Setting range: 0.00001 mm ... 100.00000 mm (X and Y) ■ Default value: 1.00000 mm (X and Y)
Read deviations of calibration standard	A file containing the deviations of the calibration standard is read
Import table of supporting points	Uploading a file <ul style="list-style-type: none"> ■ in .txt-format with position information regarding the supporting points ■ in .xml format with position information regarding the supporting points and the deviations of the calibration standard
Export table of supporting points	A file containing the position indications of the supporting points and the deviations of the calibration standard is saved
Table of supporting points	Opens the table of supporting points for manual editing

Deactivating the nonlinear axis error compensation

Before you can configure the **Nonlinear error compensation (NLEC)**, you first need to deactivate it.

Settings ► Axes ► General settings ► Error compensation ► Nonlinear error compensation (NLEC)

- ▶ Use the **ON/OFF** slider to deactivate the **Compensation** function
- > The table of supporting points is now released for editing.

Reading deviations from the calibration standard

 The manufacturer of the calibration standard usually provides you with specifications about the deviations.

Prerequisites:

- An ACF file contains the nominal values; this file must match the import scheme of the product

Further information: "Creating an ACF import file", Page 103

- **Nonlinear error compensation (NLEC)** is deactivated

Settings ► Axes ► General settings ► Error compensation ► Nonlinear error compensation (NLEC)

- ▶ Tap **Read deviations of calibration standard**
- ▶ Navigate to the desired folder
- ▶ Tap the desired file (.ACF)
- ▶ Tap **Select**
- > The nominal values are imported from the file

Creating an ACF import file

To import the calibration data into the product, you must acquire these in an ACF file.

- ▶ Open a new file in the text editor of your computer
- ▶ Save the file under a unique name and the *.acf file extension
- ▶ Enter the values, separated by tab stops as shown in the schema below

 The following specifications apply to import files:

- ▶ File names must not contain diacritics or special characters
- ▶ Use a point as decimal character

ACF schema

The ACF file contains the nominal values of the supporting points on the X and Y axes. The nominal values have been corrected by the deviations from the calibration standard.

The following example shows a grid of 5 x 5 supporting points with a spacing of 25 mm on the X axis and 20 mm on the Y axis, oriented along the X axis.

Example

MM	X
25.0	20.0
5	5
0.0000	0.0000
25.0012	-0.0010
50.0003	-0.0006
75.0010	0.0016
100.0021	0.0000
0.00005	20.0020
25.0013	20.0021
50.0013	20.0022
75.0005	20.0023
99.9996	20.0003
-0.00010	39.9998
24.9981	39.9979
49.9999	40.0001
75.0004	40.0021
100.0019	40.0008
0.00003	59.9992
25.0000	60.0018
50.0001	60.0003
75.0020	59.9990
100.0001	60.0001
-0.00003	80.0021
24.9979	80.0004
50.0020	79.9991
75.0001	79.9985
100.0010	80.0002

Explanation

The overview below shows the structure of the ACF import file.

Value	Explanation	Value	Explanation
MM	Millimeters (not configurable)	X	Alignment axis (X or Y)
25.0	Spacing of supporting points on the X axis	20.0	Spacing of supporting points on the Y axis
5	Number of supporting points on the X axis	5	Number of supporting points on the Y axis
0.0000	Nominal value of the first supporting point on the X axis	0.0000	Nominal value of the first supporting point on the Y axis
25.0012	Nominal value of the second supporting point on the X axis	-0.0010	Nominal value of the second supporting point on the Y axis

i The file contains an additional row with X and Y values for each supporting point.

i The supporting points can be indicated row by row or in a meander-shaped sequence. The product adapts the reading direction automatically.

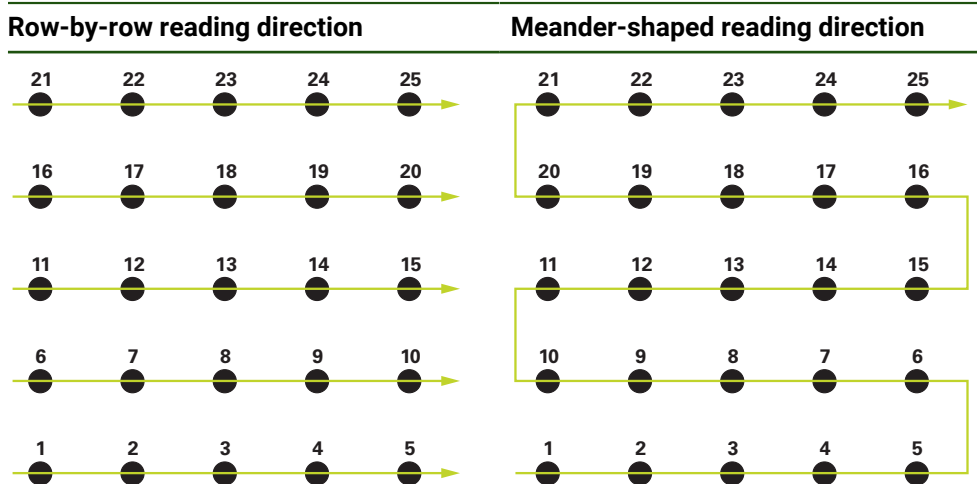

Creating a table of supporting points manually

Settings ► Axes ► General settings ► Error compensation ► Nonlinear error compensation (NLEC)

- ▶ Enter the **Number of supporting points** for the first axis
- ▶ Confirm entry with **RET**
- ▶ Enter the **Spacing of the supporting points** for the first axis
- ▶ Confirm entry with **RET**
- ▶ Repeat this procedure for the second axis
- > The number and spacing of the supporting points are written to the table of supporting points.
- > The existing table of supporting points is overwritten.

Importing the table of supporting points

To adjust the actual values of the supporting points, you can import the following file types:

- XML: contains actual values
- TXT: contains actual values
- Extended TXT: contains deviations from the nominal values

Prerequisites:

- You have an XML or TXT file that matches the import scheme of the product

Further information: "Creating an XML import file", Page 111

Further information: "Creating a TXT import file", Page 106

- **Nonlinear error compensation (NLEC)** is deactivated

Settings ▶ Axes ▶ General settings ▶ Error compensation ▶ Nonlinear error compensation (NLEC)

- ▶ Tap **Import table of supporting points**
- ▶ Navigate to the desired folder
- ▶ Tap the desired file (TXT or XML)
- ▶ Tap **Select**
- > Depending on the imported file type, the table of supporting points is adjusted as follows:
 - **XML:** The actual values are imported from the file
 - **TXT:** The actual values are imported from the file
 - **Extended TXT:** The actual values are corrected by the deviations

i In order to keep the nominal values in the original table of supporting points, define the number and spacing in the import file in the same way as in the original table of supporting points. Otherwise, the nominal values will be overwritten by the grid specified in the import file. Any deviations from the calibration standard that have been read in before will be lost.

Creating a TXT import file

- ▶ Open a new file in the text editor of your computer
- ▶ Save the file under a unique name and add the *.txt file extension
- ▶ Enter the data, separated by tab stops according to one of the schemas below:
 - TXT schema: The file contains the actual values of the supporting points
 - Extended TXT schema: The file contains deviations from the theoretical nominal value

i The following specifications apply to import files:

- ▶ File names must not contain diacritics or special characters
- ▶ Use a point as decimal character

TXT schema

The TXT file contains the actual values of the supporting points on the X and Y axes. The following example shows a grid of 5 x 5 supporting points with a spacing of 25 mm on the X axis and 20 mm on the Y axis, oriented along the X axis.

Example

MM	X
25.0	20.0
5	5
0.0000	0.0000
25.0012	-0.0010
50.0003	-0.0006
75.0010	0.0016
100.0021	0.0000
0.00005	20.0020
25.0013	20.0021
50.0013	20.0022
75.0005	20.0023
99.9996	20.0003
-0.00010	39.9998
24.9981	39.9979
49.9999	40.0001
75.0004	40.0021
100.0019	40.0008
0.00003	59.9992
25.0000	60.0018
50.0001	60.0003
75.0020	59.9990
100.0001	60.0001
-0.00003	80.0021
24.9979	80.0004
50.0020	79.9991
75.0001	79.9985
100.0010	80.0002

Explanation

The following overview explains the values that you can define individually. All values not listed here must be copied as is from the example. The values must be separated by tab stops.

Value	Explanation	Value	Explanation
MM	Unit of measurement: millimeters (alternatively: IN for inches)	X	Alignment axis (X or Y)
25.0	Spacing of supporting points on the X axis	20.0	Spacing of supporting points on the Y axis
5	Number of supporting points on the X axis	5	Number of supporting points on the Y axis
0.0000	Actual value of the first supporting point on the X axis	0.0000	Actual value of the first supporting point on the Y axis
25.0012	Actual value of the second supporting point on the X axis	-0.0010	Actual value of the second supporting point on the Y axis

 The file contains an additional row with X and Y values for each supporting point.

Extended TXT schema

The extended TXT file contains the deviations of the supporting points from the nominal values on the X and Y axes.

The following example shows a grid with 5 x 5 supporting points with a spacing of 25 mm on the X axis and 20 mm on the Y axis.

Example

```

NLEC Data File
0.91
// Serial Number = CA-1288-6631-1710
MM
ON
Number of Grid Points (x, y):
5                5
Grid Block Size (x, y):
25.0            20.0
Offset:
0                0
Station (1, 1)
0.00000         0.00000
Station (2, 1)
0.00120         -0.00100
Station (3, 1)
0.00030         -0.00060
Station (4, 1)
0.00100         0.00160
Station (5, 1)
0.00210         0.00000
Station (1, 2)
0.00005         0.00200
Station (2, 2)
0.00130         0.00210
Station (3, 2)
0.00130         0.00220
Station (4, 2)
0.00050         0.00230
Station (5, 2)
-0.00040        0.00030
Station (1, 3)
-0.00010        -0.00020
Station (2, 3)
-0.00190        -0.00210
Station (3, 3)
-0.00010        0.00010
Station (4, 3)
0.00040         0.00210
Station (5, 3)
0.00190         0.00080
Station (1, 4)

```

```

NLEC Data File
0.00003          -0.00080
Station (2, 4)
0.00000          0.00180
Station (3, 4)
-0.00010         0.00030
Station (4, 4)
0.00200          -0.00100
Station (5, 4)
0.00010          0.00010
Station (1, 5)
-0.00003         0.00210
Station (2, 5)
-0.00210         0.00040
Station (3, 5)
0.00200          -0.00090
Station (4, 5)
0.00010          -0.00150
Station (5, 5)
0.00100          0.00020
    
```

Explanation

The following overview explains the values that you can define individually. All values not listed here must be copied as is from the example.

Value	Explanation
// Serial Number = CA-1288-6631-1710	Serial number (optional)
MM	Unit of measurement: millimeters (alternatively: IN for inches)
Number of Grid Points (x, y):	
5 5	Number of supporting points on the X and Y axes
Grid Block Size (x, y):	
25.0 20.0	Spacing of the supporting points on the X and Y axes
Station (1, 1):	
0.00000 0.00000	Deviation of the first supporting point on the X and Y axes
Station (2, 1):	
0.00120 -0.00100	Deviation of the second supporting point on the X and Y axes

 The file contains a **Station (x, y)** section for each supporting point, indicating the deviations on the X and Y axes.

Creating an XML import file

To create an XML import file, you can either export the existing table of supporting points and edit it as required or create a new file from scratch.

Exporting and editing a table of supporting points

Settings ▶ Axes ▶ General settings ▶ Error compensation ▶ Nonlinear error compensation (NLEC)

- ▶ Tap **Export table of supporting points**
- ▶ Select the desired location, e.g. an external storage medium
- ▶ Navigate to the desired folder
- ▶ Save file under a unique name
- ▶ Edit the values in the XML editor or in a text editor available on your computer

i The exported XML file also contains the nominal values of the supporting points (**<group id="Standard"> </group>** section). This data will not be taken into account when the file is imported. You may remove this section from the import file, if desired.

Creating a new file

- ▶ Create a new file in the XML editor or in a text editor available on your computer
- ▶ Save the file under a unique name and add the *.xml file extension
- ▶ Enter the data as shown in the schema shown below

i The following specifications apply to import files:

- ▶ File names must not contain diacritics or special characters
- ▶ Use a point as decimal character

XML schema

The XML file contains the actual values of the supporting points on the X and Y axes. The following example shows a grid of 5 x 5 supporting points with a spacing of 25 mm on the X axis and 20 mm on the Y axis.

Example

```
<?xml version="1.0" encoding="UTF-8"?>
<configuration>
<base id="Settings">
<group id="CellSize">
<element id="x">25</element>
<element id="y">20</element>
</group>
<group id="General">
<element id="enabled">>false</element>
</group>
<group id="GridSize">
<element id="x">5</element>
<element id="y">5</element>
</group>
<group id="Level0">
<element id="Position" Angle="0" Z="0" Y="0" X="0"/>

```

```

<?xml version="1.0" encoding="UTF-8"?>
<element id="0-0" Y="0" X="0"/>
<element id="1-0" Y="-0.001" X="25.001200000000001"/>
<element id="2-0" Y="-0.0005999999999999995" X="50.000300000000003"/>
<element id="3-0" Y="0.0016000000000000001" X="75.001000000000005"/>
<element id="4-0" Y="0" X="100.0021"/>
<element id="0-1" Y="20.001999999999999" X="5.000000000000002"/>
<element id="1-1" Y="20.002099999999999" X="25.001300000000001"/>
<element id="2-1" Y="20.002199999999998" X="50.001300000000001"/>
<element id="3-1" Y="20.002300000000002" X="75.000500000000002"/>
<element id="4-1" Y="20.000299999999999" X="99.999600000000001"/>
<element id="0-2" Y="39.9998" X="-0.0001"/>
<element id="1-2" Y="39.997900000000001" X="24.998100000000001"/>
<element id="2-2" Y="40.000100000000003" X="49.999899999999997"/>
<element id="3-2" Y="40.002099999999999" X="75.000399999999999"/>
<element id="4-2" Y="40.000799999999998" X="100.001900000000001"/>
<element id="0-3" Y="59.999200000000002" X="3.000000000000001"/>
<element id="1-3" Y="60.001800000000003" X="25"/>
<element id="2-3" Y="60.000300000000003" X="49.999899999999997"/>
<element id="3-3" Y="59.999000000000002" X="75.001999999999995"/>
<element id="4-3" Y="60.000100000000003" X="100.0001"/>
<element id="0-4" Y="80.002099999999999" X="-3.000000000000001"/>
<element id="3-4" Y="79.998500000000007" X="75.000100000000003"/>
<element id="2-4" Y="79.999099999999999" X="50.002000000000002"/>
<element id="4-4" Y="80.000200000000007" X="100.001"/>
</group>
</base>
<base id="version" build="0" minor="4" major="1"/>
</configuration>

```

Explanation

The following overview explains the parameters and values that you can define individually. All items not listed here must be copied as is from the example.

Group	Parameters and values (example)	Explanation
<group id="CellSize">	<element id="x">25</element>	Spacing of supporting points on the X axis. In this example: 25 mm
	<element id="y">20</element>	Spacing of supporting points on the Y axis. In this example: 20 mm
<group id="GridSize">	<element id="x">5</element>	Number of supporting points on the X axis. In this example: 5 supporting points
	<element id="y">5</element>	Number of supporting points on the Y axis. In this example: 5 supporting points
<group id="Level0">	<element id="0-0" Y="0" X="0"/>	Actual value of the first supporting point in mm. In this example: <ul style="list-style-type: none"> ■ X = 0 ■ Y = 0
	<element id="1-0" Y="-0.001" X="25.001200000000001"/>	Actual value of the supporting point in mm. In this example: <ul style="list-style-type: none"> ■ X = -0.001 ■ Y = 25.001200000000001

For each supporting point, the group contains an additional element with these parameters.

Determining the actual values using a teach sequence

 This action cannot be undone.

Settings ▶ Axes ▶ General settings ▶ Error compensation ▶ Nonlinear error compensation (NLEC)

- ▶ To start the teach sequence, tap **Start**
- The wizard is displayed in the **Measure** menu.
- ▶ Follow the instructions of the wizard
- ▶ Measure or construct the required feature
- ▶ Tap **Confirm** in the wizard to continue



 The feature acquired last will be transferred to the table of supporting points.



- ▶ Tap **Close** to close the wizard
- Values measured in the teach sequence are transferred as actual values to the table of supporting points.
- After the teach sequence is complete, the **Measure** menu appears.

Acquire the actual values manually

Settings ▶ Axes ▶ General settings ▶ Error compensation ▶ Nonlinear error compensation (NLEC)

- ▶ Tap **Table of supporting points**
- ▶ Enter the actual values of the supporting points
- ▶ Confirm each entry with **RET**

Activating the nonlinear error compensation

Settings ▶ Axes ▶ General settings ▶ Error compensation ▶ Nonlinear error compensation (NLEC)

- ▶ Activate **Compensation** with the **ON/OFF** slide switch
- > The error compensation is applied from the next measurement.

Configuring Squareness error compensation (SEC)

Squareness error compensation (SEC) enables angular errors to be compensated during measuring point acquisition. The compensation factor is determined by comparing the deviation of the actual measurement result from the nominal angle of the spatial axes. The compensation factor is applied to the entire measuring range.

Settings ▶ Axes ▶ General settings ▶ Error compensation ▶ Squareness error compensation (SEC)

Parameter	Explanation
XY plane	Mechanical influences on the squareness of the axes relative to each other are compensated
XZ Plane	
YZ plane	

- Setting range: **85° ... 95°**
- Default value: **90**

- > The measured values (M) and nominal values (S) of the three spatial axes are displayed
- ▶ Enter the measured values of the reference standard (= nominal values)
- ▶ Activate **Compensation** with the **ON/OFF** slide switch
- > Squareness error compensation is applied from the next measurement

4.6.7 Coupling axes

If you couple axes with each other, the product offsets the position values of the two axes according to the selected calculation type. The position display shows only the principal axis with the calculated position value.

Settings ► **Axes** ► **<Axis name>**

Parameter	Explanation
Axis type	<p>Definition of the axis type</p> <p>Settings:</p> <ul style="list-style-type: none"> ■ Coupled axis: Axis whose position value is offset against a principal axis <div style="border: 1px solid black; padding: 5px; margin: 5px 0;"> <p>i Coupled axes do not appear in the position display. The position axis shows only the principal axis with the calculated position value of both axes.</p> </div> <div style="border: 1px solid black; padding: 5px; margin: 5px 0;"> <p>i For coupled axes, the product adapts the axis name automatically. The axis name consists of the name of the principal axis and the selected calculation type, e.g. +X.</p> </div>
Coupled main axis	<p>Selecting the principal axis to be coupled with the axis</p> <p>Default value: None</p>
Calculation with main axis	<p>Calculation type for the position values of the principal (main) axis and coupled axis</p> <p>Settings:</p> <ul style="list-style-type: none"> ■ +: The position values are added (principal axis + coupled axis) ■ -: The position values are subtracted (principal axis – coupled axis) ■ Default value: +

4.6.8 Reference marks

Settings ► Axes ► General settings ► Reference marks

Parameters	Explanation
Reference mark search after unit start	<p>Setting for the reference mark search after unit start</p> <p>Settings:</p> <ul style="list-style-type: none"> ■ ON: The reference mark search must be performed after startup ■ OFF: No prompt for a mandatory reference mark search is displayed after startup of the product ■ Default value: ON
All users can cancel reference mark search	<p>Specifies whether the reference mark search can be canceled by all user types</p> <p>Settings</p> <ul style="list-style-type: none"> ■ ON: The reference mark search can be canceled by users of any type ■ OFF: The reference mark search can only be canceled by users of the OEM or Setup type ■ Default value: OFF
Reference mark search	Start starts the reference mark search and opens the workspace
Reference mark search status	<p>Indicates whether the reference mark search was successful</p> <p>Display:</p> <ul style="list-style-type: none"> ■ Successful ■ Unsuccessful
Stop of reference mark search	<p>Indicates whether the reference mark search was canceled</p> <p>Display:</p> <ul style="list-style-type: none"> ■ Yes ■ No

Activating the reference mark search

The product uses the reference marks to reference the machine table to the machine, for example. If the reference mark search has been activated, a wizard appears on startup of the product and asks the user to move the axes for the reference mark search.

Prerequisite: The installed encoders have reference marks that have been configured in the axis parameters.



For encoders with EnDat interface, the reference mark search is omitted because the axes are referenced automatically.



The automatic reference mark search on startup of the product can be canceled depending on the configuration.

Further information: "Reference marks (Encoder)", Page 91



- ▶ Tap **Settings** in the main menu



- ▶ Tap **Axes**
- ▶ Open in succession:
 - **General settings**
 - **Reference marks**
- ▶ Activate **Reference mark search after unit start** with the **ON/OFF** slide switch
- > The reference marks must be traversed every time the product is started.
- > The functions of the product will only be available after the reference mark search has been completed.
- > The Reference symbol stops blinking upon successful completion of the reference mark search.
- Further information:** "Operating elements of the position display", Page 34

4.7 OEM area

In the **OEM area**, commissioning engineers can customize the product in various ways:

- **Documentation:** Adding the OEM documentation (e.g., service information)
- **Startup screen:** Defining a startup screen with the OEM's company logo
- **Screenshots:** Configuring the unit for screenshots with the program ScreenshotClient

4.7.1 Adding documentation

You can store and display the product's documentation right on the product.



Only documents in the *.pdf file format can be added as a documentation. The product does not display documents provided in other file formats.

Settings ► Service ► OEM area ► Documentation

Parameter	Explanation
Add OEM service info	Selection of the file (file type PDF). The file is copied automatically to the corresponding folder of the product

4.7.2 Adding a startup screen

You can define an OEM-specific startup screen, e.g. the company name or logo, which will be displayed when the product is switched on. An image file with the following properties needs to be stored on the product for this purpose:

- File type: PNG or JPG
- Resolution: 96 ppi
- Image format: 16:10 (other formats will be scaled proportionally)
- Image size: Max. 1280 x 800 px

Settings ► Service ► OEM area ► Startup screen

Parameter	Explanation
Add startup screen	Selecting the image file that is to be displayed as opening screen (file type: PNG or JPG) Further information: "Adding a startup screen", Page 118
Delete startup screen	Delete clears the user-defined opening screen and restores the default view



When you save the user files, the OEM-specific opening screen is also saved and can be restored.

Further information: "Back up user files", Page 121

4.7.3 Configuring the unit for screenshots

ScreenshotClient

With the ScreenshotClient PC software, you can use a computer to take screenshots of the active screen of the product.

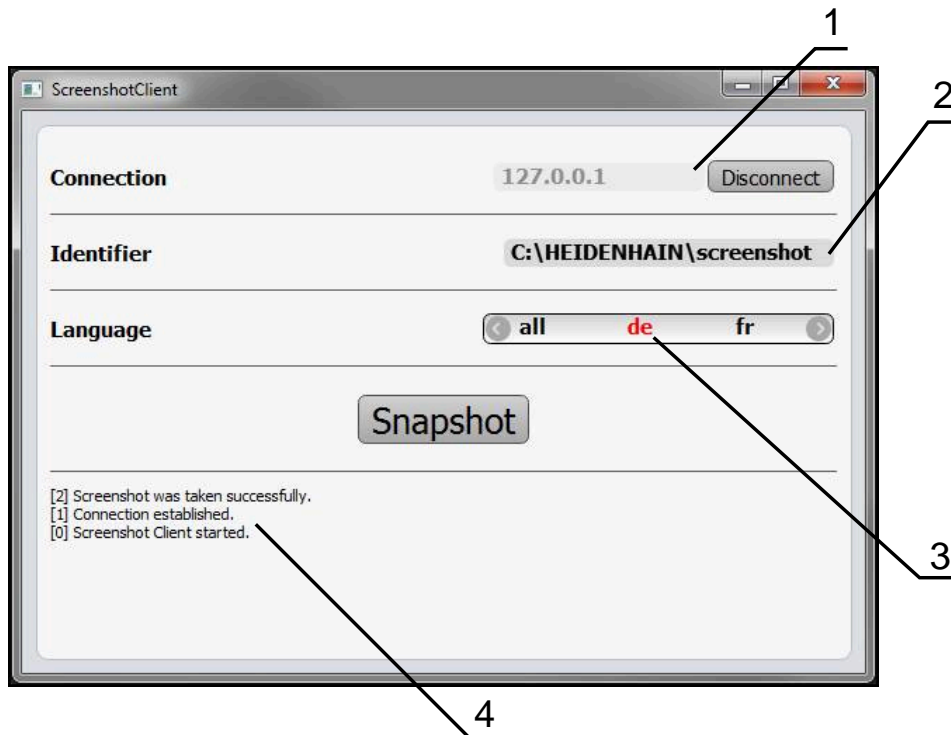

Figure 21: The ScreenshotClient user interface

- 1 Connection status
- 2 File path and file name
- 3 Language selection
- 4 Status messages

i ScreenshotClient is included in the standard installation of **GAGE-CHEK 2000 Demo**.

m For a detailed description, please refer to the **GAGE-CHEK 2000 Demo User's Manual**.

- ▶ <https://www.heidenhain.com/service/downloads/software>
- ▶ Select a category
- ▶ Select the product family
- ▶ Select the desired language

Further information: "Demo software for the product", Page 8

Activating remote access for screenshots

To connect ScreenshotClient with the product via the computer you need to activate **Remote access for screenshots** on the product.

Settings ▶ Service ▶ OEM area

Parameter	Explanation
Remote access for screenshots	<p>Permitting a network connection with the ScreenshotClient program so that ScreenshotClient can take screenshots of the unit from a computer</p> <p>Settings:</p> <ul style="list-style-type: none"> ■ ON: Remote access is possible ■ OFF: Remote access is not possible ■ Default value: OFF



When the unit is shut down, **Remote access for screenshots** is automatically deactivated.

4.8 Backing up data

4.8.1 Back up settings

The product's settings can be backed up as a file so that they are available after a reset to the factory default settings has been performed or for installation on multiple units.

Settings ▶ Service ▶ Back up and restore

Parameter	Explanation
Back up settings	Backing up of settings of the product

Performing Complete backup

During a complete backup of the configuration, all settings of the product are backed up.

- ▶ Tap **Complete backup**
- ▶ If required, connect a USB mass storage device (FAT32 format) to a USB port of the product
- ▶ Select the folder to which you want to copy the configuration data
- ▶ Specify a name for the configuration data, e.g. "<yyyy-mm-dd>_config"
- ▶ Confirm the entry with **RET**
- ▶ Tap **Save as**
- ▶ Tap **OK** to confirm the successful backup of the configuration
- > The configuration file has been backed up.

Safely removing a USB mass storage device



- ▶ Tap **File management** in the main menu
- ▶ Navigate to the list of storage locations
- ▶ Tap **Safely remove**
- The message **The storage medium can be removed now.** appears.
- ▶ Disconnect the USB mass storage device



4.8.2 Back up user files

The user files of the product can be backed up as a file to make it available after a reset to the factory default settings. This, together with the backing up of the settings, enables you to back up the complete configuration of your product.

 All files from all user groups that are stored in the respective folders are backed up and can be restored as user files.
The files in the **System** folder are not restored.

Settings ▶ Service ▶ Back up and restore

Parameter	Explanation
Back up user files	Backing up of user files of the product

Performing back up

The user files can be backed up as a ZIP file on a USB mass storage device or connected network drive.

- ▶ Open in succession:
 - **Back up and restore**
 - **Back up user files**
- ▶ Tap **Save as ZIP**
- ▶ If required, connect a USB mass storage device (FAT32 format) to a USB port of the product
- ▶ Select the folder to which you want to copy the ZIP file
- ▶ Enter a name for the ZIP file, e.g., "<yyyy-mm-dd>_config"
- ▶ Confirm the entry with **RET**
- ▶ Tap **Save as**
- ▶ Tap **OK** to confirm successful backup of the user files
- The user files were backed-up.

Safely removing a USB mass storage device



- ▶ Tap **File management** in the main menu
- ▶ Navigate to the list of storage locations
- ▶ Tap **Safely remove**
- The message **The storage medium can be removed now.** appears.
- ▶ Disconnect the USB mass storage device



5

Setup

5.1 Overview

This chapter contains all the information necessary for setting up the product.

During setup, the setup engineer (**Setup**) configures the product for use with the measuring machine in the respective applications. This includes, for example, setting up operators and configuring networks and printers.

 Make sure that you have read and understood the "Basic Operation" chapter before carrying out the actions described below.
Further information: "Basic Operation", Page 19

 The following steps must be performed only by qualified personnel.
Further information: "Personnel qualification", Page 16

5.2 Logging in for setup

5.2.1 User login

To set up the product, the **Setup** user must log in.



- ▶ Tap **User login** in the main menu
- ▶ If required, log out the user who is currently logged in
- ▶ Select the **Setup** user
- ▶ Tap the **Password** input field
- ▶ Enter the password "**setup**"

 If a password other than the default password has been assigned to the user, ask a **Setup** or **OEM** user for the assigned password.
If the password is no longer known, contact a HEIDENHAIN service agency.



- ▶ Confirm the entry with **RET**
- ▶ Tap **Log in**

5.2.2 Performing the reference mark search after startup

 If the reference mark search after unit start is active, then all of the unit's functions will be disabled until the reference mark search has been successfully completed.

Further information: "Reference marks (Encoder)", Page 91

 For encoders with EnDat interface, the reference mark search is omitted because the axes are referenced automatically.

If the reference mark search is active on the unit, then a wizard will ask you to traverse the reference marks of the axes.

- ▶ After logging in, follow the instructions of the wizard
- > The Reference symbol stops blinking upon successful completion of the reference mark search.

Further information: "Operating elements of the position display", Page 34

Further information: "Activating the reference mark search", Page 117

5.2.3 Setting the language

The user interface language is English. You can change to another language, if desired.



- ▶ Tap **Settings** in the main menu



- ▶ Tap **User**
- > The logged-in user is indicated by a check mark.
- ▶ Select the logged-in user
- > The language selected for the user is indicated by a national flag in the **Language** drop-down list.
- ▶ Select the flag for the desired language from the **Language** drop-down list
- > The user interface is displayed in the selected language.

5.2.4 Changing the password

You must change the password to prevent unauthorized configuration.

The password is confidential and must not be disclosed to any other person.



- ▶ Tap **Settings** in the main menu



- ▶ Tap **User**
 - > The logged-in user is indicated by a check mark.
 - ▶ Select the logged-in user
 - ▶ Tap **Password**
 - ▶ Enter the current password
 - ▶ Confirm entry with **RET**
 - ▶ Enter the new password and repeat it
 - ▶ Confirm entry with **RET**
 - ▶ Tap **OK**
 - ▶ Close the message with **OK**
 - > The new password is available the next time the user logs in.

5.3 Single steps for setup

i The following setup steps build on each other.

- ▶ To correctly set up the product, make sure to perform the steps in the order described here

i The commissioning engineer (**OEM**) may have already carried out several basic settings.

Prerequisite: You are logged on as a user of the **Setup** type (see "Logging in for setup", Page 123).

Basic settings

- Setting the date and time
- Setting the units of measure
- Entering and configuring users
- Adding the Operating Instructions
- Configuring the network
- Configuring the network drive
- Configuring operation with a mouse or touchscreen

Configuring the interfaces

- Configuring the RS-232 interface
- Network protocols
 - MQTT
 - REST
- Switching functions
- Remote access
- Activating the data connection

Backing up data

- Back up settings
- Back up user files

NOTICE

Loss of or damage to configuration data!

If the product is disconnected from the power source while it is on, the configuration data can be lost or corrupted.

- ▶ Back up the configuration data and keep the backup for recovery purposes

5.3.1 Setting the date and time

Settings ► General ► Date and time

Parameter	Explanation
Date and time	Current date and time of the product <ul style="list-style-type: none"> Settings: Year, Month, Day, Hour, Minute Default setting: Current system time
Date format	Format in which the date is displayed Settings: <ul style="list-style-type: none"> MM-DD-YYYY: Month, day, year DD-MM-YYYY: Day, month, year YYYY-MM-DD: Year, month, day Default setting: YYYY-MM-DD (e.g. "2016-01-31")

5.3.2 Setting the units of measure

You can set various parameters to define the units of measure, rounding methods and decimal places.

Settings ► General ► Units

Parameter	Explanation
Unit for linear values	Unit of measure for linear values <ul style="list-style-type: none"> Settings: Millimeters or Inch Default setting: Millimeters
Rounding method for linear values	Rounding method for linear values Settings: <ul style="list-style-type: none"> Commercial: Decimal places from 1 to 4 are rounded down, decimal places from 5 to 9 are rounded up Round off: Decimal places from 1 to 9 are rounded down Round up: Decimal places from 1 to 9 are rounded up Truncate: Decimal places are truncated without rounding up or down Round to 0 and 5: Decimal places ≤ 24 or ≥ 75 are rounded to 0, decimal places ≥ 25 or ≤ 74 are rounded to 5 Default setting: Commercial
Decimal places for linear values	Number of decimal places for linear values Setting range: <ul style="list-style-type: none"> Millimeters: 0 ... 5 Inch: 0 ... 7 Default value: <ul style="list-style-type: none"> Millimeters: 4 Inch: 6
Unit for angular values	Unit for angular values Settings: <ul style="list-style-type: none"> Radian: Angles in radian (rad) Decimal degrees: Angles in degrees ($^{\circ}$) with decimal places Deg-Min-Sec: Angles in degrees ($^{\circ}$), minutes [$'$] and seconds [$''$] Default setting: Decimal degrees

Parameter	Explanation
Rounding method for angular values	<p>Rounding method for decimal angular values</p> <p>Settings:</p> <ul style="list-style-type: none"> ■ Commercial: Decimal places from 1 to 4 are rounded down, decimal places from 5 to 9 are rounded up ■ Round off: Decimal places from 1 to 9 are rounded down ■ Round up: Decimal places from 1 to 9 are rounded up ■ Truncate: Decimal places are truncated without rounding up or down ■ Round to 0 and 5: Decimal places ≤ 24 or ≥ 75 are rounded to 0, decimal places ≥ 25 or ≤ 74 are rounded to 5 ■ Default setting: Commercial
Decimal places for angular values	<p>Number of decimal places for angular values</p> <p>Setting range:</p> <ul style="list-style-type: none"> ■ Radian: 0 ... 7 ■ Decimal degrees: 0 ... 5 ■ Deg-Min-Sec: 0 ... 2 <p>Default value:</p> <ul style="list-style-type: none"> ■ Radian: 5 ■ Decimal degrees: 3 ■ Deg-Min-Sec: 0
Decimal separator	<p>Separator for the display of values</p> <ul style="list-style-type: none"> ■ Settings: Point or Comma ■ Default setting: Point

5.3.3 Entering and configuring users

The following user types, which have different rights, are defined in the product's factory default settings:

- **OEM**
- **Setup**
- **Operator**

Creating a user and password

You can create new **Operator** users. You can use any characters for the user ID and the password. These entries are case-sensitive.

Prerequisite: An **OEM** or **Setup** user is logged in.

 It is not possible to create new **OEM** or **Setup**-type users.

Settings ► User ► +

Parameter	Explanation
	Adds a new user of the Operator type It is not possible to add further OEM and Setup users.
User ID	The User ID is displayed for user selection, e.g., at the login prompt. The User ID cannot be changed once it has been defined.
Name	Name of the user
Password	Entering a password for login
Repeat password	Repeating the password
Show password	You can show the contents of the password fields in plain text and hide them again.

Configuring and deleting a user

Settings ► User ► User name

Parameter	Explanation
Name	Name of the user
First name	First name of the user
Department	Department of the user
Group	Stating the group to which the user belongs
Password	The password can be changed.
Language	Selecting the language to be displayed for the user
Auto login	Selecting whether the user is to be logged on automatically without entering a password. The user must have been logged on before the device is switched off.

 If automatic user login is active for one or more users, the last user who logged in is automatically logged in when the product is switched on. Neither the user ID nor the password needs to be entered.

Remove user account The user can be removed by an OEM user or Setup user.

 **OEM** and **Setup**-type users cannot be deleted.

5.3.4 Adding the Operating Instructions

The product provides the possibility to upload the corresponding Operating Instructions in the desired language. The Operating Instructions can be copied from the supplied USB mass storage device to the product.

The latest version can be downloaded from the download area at www.heidenhain.com.

Settings ► Service ► Documentation

Parameter	Explanation
Add Operating Instructions	Adding the Operating Instructions in the desired language

5.3.5 Configuring the network

Network settings



Contact your network administrator for the correct network settings for configuring the product.

Settings ► Interfaces ► Network ► X116

Parameter	Explanation
MAC address	Unique hardware address of the network adapter
DHCP	Dynamically assigned network address of the product <ul style="list-style-type: none"> Settings: ON or OFF Default value: ON
IPv4 address	Network address consisting of four octets The network address is automatically assigned if DHCP is active, or it can be entered manually <ul style="list-style-type: none"> Setting range: 0.0.0.1 ... 255.255.255.255
IPv4 subnet mask	Identifier within the network, consisting of four octets The subnet mask is automatically assigned if DHCP is active, or it can be entered manually. <ul style="list-style-type: none"> Setting range: 0.0.0.0 ... 255.255.255.255
IPv4 standard gateway	Network address of the router connecting a network <div data-bbox="699 1200 758 1258" data-label="Image"> </div> <p>The network address is automatically assigned if DHCP is active, or it can be entered manually.</p> <ul style="list-style-type: none"> Setting range: 0.0.0.1 ... 255.255.255.255
IPv6 SLAAC	Network address with extended namespace Only required if supported in the network <ul style="list-style-type: none"> Settings: ON or OFF Default value: OFF
IPv6 address	Automatically assigned if IPv6 SLAAC is active
IPv6 subnet prefix length	Subnet prefix in IPv6 networks
IPv6 standard gateway	Network address of the router connecting a network
Preferred DNS server	Primary server for mapping the IP address
Alternative DNS server	Optional server for mapping the IP address

5.3.6 Configuring the network drive

You will need the following data for configuring the network drive:

- **Name**
- **Server IP address or host name**
- **Shared folder**
- **User name**
- **Password**
- **Network drive options**

Further information: "Connecting a network peripheral", Page 72



Contact your network administrator for the correct network settings for configuring the product.

Settings ► Interfaces ► Network drive

Parameter	Explanation
Name	Folder name displayed in the file management Default value: Share (cannot be changed)
Server IP address or host name	Name or network address of the server
Shared folder	Name of the shared folder
User name	Name of the authorized user
Password	Password of the authorized user
Show password	Display of the password in plain text <ul style="list-style-type: none"> ■ Settings: ON or OFF ■ Default value: OFF
Network drive options	Configuration of the Authentication for encrypting the password in the network Settings: <ul style="list-style-type: none"> ■ None ■ Kerberos V5 authentication ■ Kerberos V5 authentication and packet signing ■ NTLM password hashing ■ NTLM password hashing with signing ■ NTLMv2 password hashing ■ NTLMv2 password hashing with signing ■ Default value: None Configuration of the Mount options Settings: <ul style="list-style-type: none"> ■ Default value: nounix,noserverino

5.3.7 Configuring operation with a mouse or touchscreen

The product can be operated either via the touchscreen or a connected (USB) mouse. If the product is in its factory default setting, touching the touchscreen deactivates the mouse. Alternatively, you can set that the product is operated either only via the mouse or only via the touchscreen.

Prerequisite: A USB mouse is connected to the product.

Further information: "Connecting input devices", Page 72

Settings ▶ General ▶ Input devices

Parameter	Explanation
Mouse substitute for multitouch gestures	<p>Specifies whether mouse operation should replace operation using the touchscreen (multitouch)</p> <p>Settings:</p> <ul style="list-style-type: none"> ■ Auto (until first multitouch): Touching the touchscreen causes mouse deactivation ■ On (no multitouch): Operation only possible with the mouse, the touchscreen is deactivated ■ Off (only multitouch): Operation only possible with the touchscreen, the mouse is deactivated ■ Default setting: Auto (until first multitouch)
USB keyboard layout	<p>If a USB keyboard is connected:</p> <ul style="list-style-type: none"> ■ Language selection of the keyboard assignment

5.3.8 Configuring the RS-232 interface

In the product settings you configure the interface for data transfer to the computer.

Requirement: A USB-RS232 adapter is connected to X32.



- ▶ Tap **Settings** in the main menu



- ▶ Tap **Interfaces**
- ▶ Tap **RS-232**
- ▶ Tap **X32**
- ▶ The following settings are sent through the RS-232 adapter, and can be adapted as needed for the receiver software:
 - **Baud rate**
 - **Data bits**
 - **Parity**
 - **Stop bits**
 - **Flow control**

RS-232

Settings ► Interfaces ► RS-232 ► X32

The parameters of the **RS-232** adapter are output.

Parameter	Explanation
Baud rate	Configuration of the transfer rate Setting range: 1 ... 115200
Data bits	Selection of the number of data bits Settings: <ul style="list-style-type: none"> ■ 5 bits ■ 6 bits ■ 7 bits ■ 8 bits
Parity	Selection of the parity bit for verification Settings: <ul style="list-style-type: none"> ■ None ■ Even ■ Odd ■ Space ■ Mark
Stop bits	Selection of the stop bit for synchronization Settings: <ul style="list-style-type: none"> ■ 1 bit ■ 2 bits
Flow control	Selection of the data flow Settings: <ul style="list-style-type: none"> ■ None ■ Hardware ■ Xon/Xoff

Selecting a data format

By assigning a data format to the functions for the measured value output, you specify the format in which the measured values will be sent to the computer. For this purpose, you can use the **Standard** and **Steinwald** data formats, or create your own data format (see "Creating your own data format", Page 138).

Selecting a data format



- ▶ Tap **Settings** in the main menu



- ▶ Tap **Interfaces**
- ▶ Tap **Data transfer**
- ▶ In the **RS-232** drop-down list, select the type of interface



In the following drop-down lists you can choose a separate data format for each function:

- **Data format for data transfer**
- **Data format for touch-probe-triggered data transfer**
- **Data format for continuous data transfer**
- **Data format for switching-function-triggered data transfer**

Each drop-down list contains the data formats **Standard**, **Steinwald**, **MyFormat1**, and all self-created data formats.

- ▶ In order to assign a data format to a function, select the desired data format in the respective drop-down list

Further information: "Activating the interface for Data transfer", Page 147

Brief description of the Standard and Steinwald data formats

In the following, you will find a description of data output in the **Standard** and **Steinwald** data formats. The **Standard** and **Steinwald** data formats cannot be changed.



The **Standard** and **Steinwald** data formats transfer measured values only when the following axis names are assigned: X, Y, Z, Q, R, D, L, W, A, C, f, Lx, Ly, or Lz.

The minimum, maximum, and range values are transferred only if the axis names X, Y, or Q are assigned.



If you want to use specific axis names and transfer measured values to a computer, you must modify, for example, **MyFormat1.xml** or another format file you created by adding the axis names that you assigned.

Further information: "Creating your own data format", Page 138

Data output in the data format Standard

```

2020-07-29T07:50:06.965
X 20.023
X MIN 19.987
X MAX 20.035
X RANGE 0.048
Y 24.090
Y MIN 23.952
Y MAX 24.190
Y RANGE 0.238
    
```

Figure 22: Example of a transfer for the X and Y axes with the active **MinMax** function in the data format **Standard**

Example: **X MIN 19.987 mm**

Start of the transfer block							
2020-07-29			T07:50:06.965			<CR>	<LF>
Date in yyyy-mm-dd			Time in hh:mm:ss.f				
X	MIN		19	.	987	<CR>	<LF>
1	2	3	4	5	6	7	8
						<CR>	<LF>
End of the transfer block, space							

- 1 Axis name
- 2 Function (MIN, MAX, RANGE)
- 3 Algebraic sign (< 0, then minus sign)
- 4 Digits before the decimal point
- 5 Decimal point
- 6 Digits after the decimal point
- 7 Backwards movement of the cursor to the beginning of the line (Carriage return)
- 8 Line feed

Data output in the data format Steinwald

```

START
2020-07-29T07:49:16.008
X 20.024 mm
X MIN 19.987 mm
X MAX 20.035 mm
X RANGE 0.048 mm
Y 24.090 mm
Y MIN 23.952 mm
Y MAX 24.190 mm
Y RANGE 0.238 mm
END
    
```

Figure 23: Example of a transfer for the X and Y axes with the active **MinMax** function in the data format **Steinwald**

Example: **X MIN 19.987 mm**

START							<CR>	<LF>
Start of the transfer block								
2020-07-29			T07:49:16.008				<CR>	<LF>
Date in yyyy-mm-dd			Time in hh:mm:ss.f					
X	MIN		19	.	987	mm	<CR>	<LF>
1	2	3	4	5	6	7	8	9
END							<CR>	<LF>
End of the transfer block								

- 1 Axis name
- 2 Function (MIN, MAX, RANGE)
- 3 Algebraic sign (< 0, then minus sign)
- 4 Digits before the decimal point
- 5 Decimal point
- 6 Digits after the decimal point
- 7 Unit (in this example: millimeter)
- 8 Backwards movement of the cursor to the beginning of the line (Carriage return)
- 9 Line feed

Creating your own data format

In the file management you will find a file that you can copy to a storage medium and then adapt it individually on a computer. Then you can copy the new file to the file storage area of the product and assign it to a function.

Data formats are saved as XML files



- ▶ Tap **File management** in the main menu
- ▶ Open in succession:
 - **Internal**
 - **User**
 - **DataTransfer**
- The folder contains the file **MyFormat1.xml**
- ▶ Copy the file **MyFormat1.xml** to a transfer medium
- ▶ Rename file
- ▶ Edit the file in an XML editor or the computer's text editor
- ▶ Copy the file from the transfer medium to the following folder of the product: **Internal ▶ User ▶ DataTransfer**



In order to prevent your data formats from being removed when the firmware is updated, save each file under a separate name.

When the firmware is updated, the **MyFormat1** file in the **DataTransfer** folder is reset to the status it had when shipped. The file is automatically recreated if it no longer exists. Other files in the **DataTransfer** folder are not affected by a firmware update.

Further information: "Managing folders and files", Page 153

Further information: "Activating the interface for Data transfer", Page 147

XML schema of the MyFormat1.xml file

```

<configuration>
  <base id="Settings">
    <group id="General">
      <group id="Format">
        <group id="MyFormat1">
          <element id="General" prefix="" suffix="" previousValues="false" writeLabel="true" writeUnit="true" writeTimestamp="false" newlineAfterTimestamp="false"/>
          <element id="X MIN" unit="mm" base="10" factor="1" newline="false" prefix="" suffix="" decimalPlaces="3" digits="0" positiveSign="false"/>
          <element id="X MAX" unit="mm" base="10" factor="1" newline="false" prefix="" suffix="" decimalPlaces="3" digits="0" positiveSign="false"/>
          <element id="X RANGE" unit="mm" base="10" factor="1" newline="false" prefix="" suffix="" decimalPlaces="3" digits="0" positiveSign="false"/>
          <element id="Y MIN" unit="mm" base="10" factor="1" newline="false" prefix="" suffix="" decimalPlaces="3" digits="0" positiveSign="false"/>
          <element id="Y MAX" unit="mm" base="10" factor="1" newline="false" prefix="" suffix="" decimalPlaces="3" digits="0" positiveSign="false"/>
          <element id="Y RANGE" unit="mm" base="10" factor="1" newline="false" prefix="" suffix="" decimalPlaces="3" digits="0" positiveSign="false"/>
          <element id="Z MIN" unit="mm" base="10" factor="1" newline="false" prefix="" suffix="" decimalPlaces="3" digits="0" positiveSign="false"/>
          <element id="Z MAX" unit="mm" base="10" factor="1" newline="false" prefix="" suffix="" decimalPlaces="3" digits="0" positiveSign="false"/>
          <element id="Z RANGE" unit="mm" base="10" factor="1" newline="false" prefix="" suffix="" decimalPlaces="3" digits="0" positiveSign="false"/>
          <element id="Q MIN" unit="deg" base="10" factor="1" newline="false" prefix="" suffix="" decimalPlaces="3" digits="0" positiveSign="false"/>
          <element id="Q MAX" unit="deg" base="10" factor="1" newline="false" prefix="" suffix="" decimalPlaces="3" digits="0" positiveSign="false"/>
          <element id="Q RANGE" unit="deg" base="10" factor="1" newline="false" prefix="" suffix="" decimalPlaces="3" digits="0" positiveSign="false"/>
        </group>
      </group>
    </base>
  <base id="version" major="0" minor="0" build="0"/>
</configuration>

```

Figure 24: Data format **MyFormat1.xml**

- 1 Header
- 2 Name of the data format that appears in the **Settings** menu
- 3 General data format settings
- 4 Settings of the axes
- 5 Footer
- 6 End of the data format

The following overview explains the parameters and values that you can define individually. All elements not listed here must be kept as they are.

Element and parameter	Default value	Explanation
group id	"MyFormat1"	Name of the file format that is displayed in the Settings menu
element prefix	" "	Character string that is output before the send block or measured value Numbering of send blocks: If in the line ID="General" the value is "%0x" then the send blocks are numbered sequentially; x defines the quantity of characters for the numbering (x = 0 ... 9) Example: <ul style="list-style-type: none"> ■ prefix="%04" ■ The first send block is assigned the number 0001
element suffix	" "	Character string that is output after the send block or measured value
element previousValues	"false"	<ul style="list-style-type: none"> ■ "true": The previous send block is output in addition to the current send block ■ "false": Only the current send block is output
element writeLabel	"true"	<ul style="list-style-type: none"> ■ "true": The axis name is output before the measured value ■ "false": The axis name is not output
element writeUnit	"true"	<ul style="list-style-type: none"> ■ "true": The unit is output after the measured value Prerequisite: A value must be defined for the "element unit" parameter (see below) ■ "false": The unit is not output
element writeTimestamp	"true"	Time stamp for the send block in the format "yyyy-MM-ddThh:mm:ss.zzz" The value is inserted after the <code>prefix</code> attribute. In combination with the <code>previousValues="true"</code> attribute, the first (current) value receives the current time upon sending. The second (previous) value retains its original time stamp
element newlineAfterTimestamp	"true"	A page break is inserted after the time stamp Only if attribute <code>writeTimestamp="true"</code>

Element and parameter	Default value	Explanation
element id	"X"	<p>Measured value to which the subsequent parameters apply; each measured value is defined in its own line</p> <p>Possible values:</p> <ul style="list-style-type: none"> ■ "X": Current position of X axis ■ "X MIN": Minimum of X axis ■ "X MAX": Maximum of X axis ■ "X RANGE": Range of X axis ■ "Y": Current position of Y axis ■ "Y MIN": Minimum of Y axis ■ "Y MAX": Maximum of Y axis ■ "Y RANGE": Range of Y axis ■ "Z": Current position of Z axis ■ "Z MIN": Minimum of Z axis ■ "Z MAX": Maximum of Z axis ■ "Z RANGE": Range of Z axis ■ "Q": Current position of Q axis ■ "Q MIN": Minimum of Q axis ■ "Q MAX": Maximum of Q axis ■ "Q RANGE": Range of Q axis
element unit	"mm"	<p>The measured value is output in the unit millimeters.</p> <p>Possible values: "mm", "inch", "deg", "dms", "rad"</p> <p>If no value is defined, the units are not adapted</p>
element base	"10"	<ul style="list-style-type: none"> ■ "10": Measured value is output as a decimal value ■ "16": Measured value is output as a hexadecimal value
element factor	"1"	<p>Factor by which the measured value is multiplied</p> <p>Example:</p> <ul style="list-style-type: none"> ■ Measured value: 43.67 ■ factor="100" ■ Measured value output: 4367.00
element newline	"false"	<ul style="list-style-type: none"> ■ "true": There is a line break after the measured value ■ "false": There is no line break after the measured value
element decimalPlaces	"3"	<p>Number of decimal places to which the measured value is rounded</p>
element digits	"0"	<p>Number of digits before the decimal separator to which the measured value is rounded according to commercial practice</p> <p>Example:</p> <ul style="list-style-type: none"> ■ Measured value: 43.67 ■ digits="4" ■ Measured value output: 0043.67
element positiveSign	"false"	<ul style="list-style-type: none"> ■ "true": Output a plus sign before the measured value ■ "false": Do not output a plus sign before the measured value

5.3.9 Network protocols

Settings ► Interfaces ► Network protocols ► MQTT

Parameter	Explanation
MQTT Broker address	IP address of the MQTT Broker
MQTT Port	Port number

Settings ► Interfaces ► Network protocols ► REST

Parameter	Explanation
HTTP Port	Port number

5.3.10 Switching functions

Settings ► Interfaces ► Switching functions

Parameter	Explanation
Axes	Configuration of the inputs for the purpose of setting all of the axes, or individual axes, to zero
Switch the unit for linear values	Assignment of the digital input in accordance with the pin layout in order to execute the respective function
Switch the unit for angular values	Default setting: Not connected
Start reference mark search	Assignment of the digital input in accordance with pin layout in order to start the reference mark search Default setting: Not connected
Stop reference mark search	Assignment of the digital input in accordance with pin layout in order to stop the reference mark search Default setting: Not connected

5.3.11 Remote access

Basics of remote access

The remote access functions enable the interrogation and monitoring of data, as well as the remote control of the product.

For remote control, the actions are divided into two categories:

- Actions that apply to the entire product. You define the corresponding settings in the device settings.
- Actions that apply to a specific function. You define the required settings in the corresponding configuration dialog of the respective function.

Difference between measured value output and remote access

In the case of measured value output, the product triggers the function (for example, after you have tapped the Measured value output button).

In the case of remote access, the remote station triggers the transmission (for example, the computer that evaluates the measured values).

Data transfer methods

The product provides the following data transfer methods for remote access:

- Switching functions and position-dependent switching functions
- Serial interface with RS-232
- Ethernet with MQTT protocol
- Ethernet with HTTP protocol (as a REST implementation)

Text-based data transfer methods (such as RS-232, MQTT, and REST) require a protocol. You select the data transfer method in the settings under Data transfer.

Further information: "Activating the interface for Data transfer", Page 147

Data transfer via switching functions

For remote access via switching functions, the change in a signal level at the switching input triggers a function.

For remote access via position-dependent switching functions, a position value triggers the change in a signal level at the switching output.

The switching inputs and switching outputs are assigned to specific actions based on a list containing the currently available inputs and outputs. The list of available inputs and outputs varies in the number of available connections, depending on the product variant.

Further information: "Switching functions", Page 141

Data transfer via RS-232

Both devices have equal rights in transmissions via the serial interface RS-232. The connection is permanent.

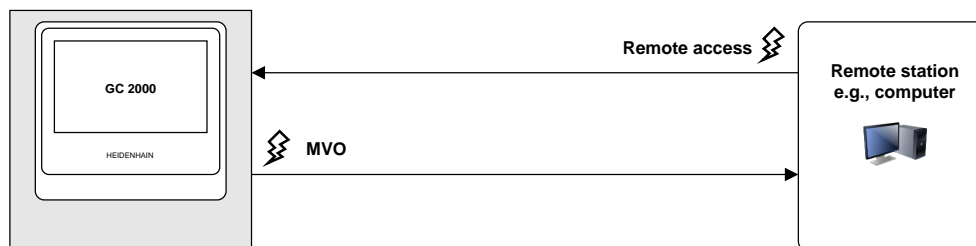

Data transfer via MQTT

Message Queuing Telemetry Transport (MQTT) is an open network protocol for machine-to-machine communication (M2M), enabling the transmission of telemetry data in the form of messages between individual devices.

Both devices have equal rights in transmissions via MQTT. The connection is permanent and via an intermediate module, the broker.

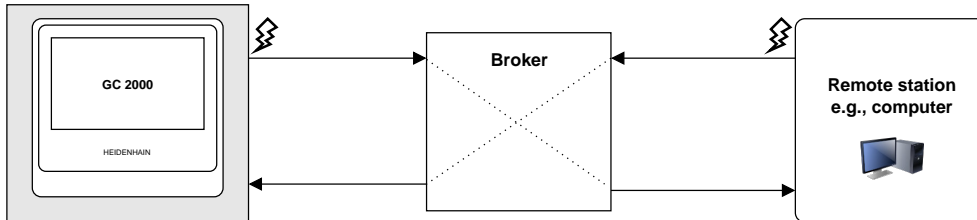

Data transfer via HTTP (REST)

Representational State Transfer (REST) uses HTTP as an application layer protocol. REST focuses on machine-to-machine communication.

In transmissions via REST, the remote station triggers the data transfer. The connection is re-established for every transmission.

A separate, existing connection is available for measured value output.

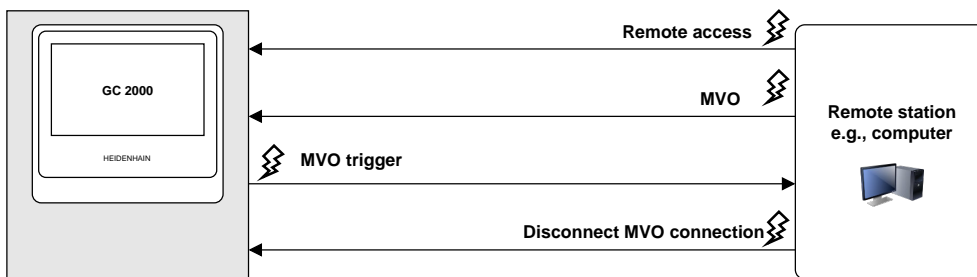

Generally valid remote access commands

In its default setting, the product responds to four immutable basic commands.

Parameter	Explanation
commands	List of all valid remote access commands. The commands available for an external application are thus always known.
firmwareVersion	Remote query of firmware version
firmwareCoreVersion	Remote query of firmware core version
serialNumber	Remote query of serial number

Remote commands

Settings ► Interfaces ► Remote commands

There is a default value for each remote control command. You can overwrite or delete the values, or reset them to their default values.

Parameter	Explanation
Clear all user commands	Deleting all remote control commands
Set all user commands to default values	Resetting all remote control commands to default values

Parameter	Explanation										
Zero all axes	Simultaneous zero reset of all axes <ul style="list-style-type: none"> ■ Command to be transferred ■ Reset user command to default <ul style="list-style-type: none"> ■ Default value: zeroAll 										
Zero the axis	Zero reset of a selected axis <ul style="list-style-type: none"> ■ Command to be transferred ■ Reset user command to default <ul style="list-style-type: none"> ■ Default value: zeroC ■ Indexes Possible indexes between 1 and 3 										
Switch the unit for linear values	Toggling the unit for linear values <ul style="list-style-type: none"> ■ Command to be transferred ■ Reset user command to default <ul style="list-style-type: none"> ■ Default value: toggleLinearUnit 										
Switch the unit for angular values	Toggling the unit for angular values <ul style="list-style-type: none"> ■ Command to be transferred ■ Reset user command to default <ul style="list-style-type: none"> ■ Default value: toggleAngularUnit 										
State of reference mark search	Querying the state of reference mark search <ul style="list-style-type: none"> ■ Command to be transferred ■ Reset user command to default <ul style="list-style-type: none"> ■ Default value: stateREF ■ Indexes Possible indexes between 1 and 3 ■ Possible states <table border="1"> <thead> <tr> <th>State</th> <th>Description</th> </tr> </thead> <tbody> <tr> <td>Started</td> <td>Reference mark search was started</td> </tr> <tr> <td>Cancelled</td> <td>Reference mark search was canceled</td> </tr> <tr> <td>Found</td> <td>Reference mark was found</td> </tr> <tr> <td>No Mark</td> <td>No reference mark was defined in the settings of the encoders</td> </tr> </tbody> </table>	State	Description	Started	Reference mark search was started	Cancelled	Reference mark search was canceled	Found	Reference mark was found	No Mark	No reference mark was defined in the settings of the encoders
State	Description										
Started	Reference mark search was started										
Cancelled	Reference mark search was canceled										
Found	Reference mark was found										
No Mark	No reference mark was defined in the settings of the encoders										
Start reference mark search	Starting the reference mark search <ul style="list-style-type: none"> ■ Command to be transferred ■ Reset user command to default <ul style="list-style-type: none"> ■ Default value: startREF 										
Stop reference mark search	Stopping the reference mark search <ul style="list-style-type: none"> ■ Command to be transferred ■ Reset user command to default <ul style="list-style-type: none"> ■ Default value: stopREF 										

Parameter	Explanation
Error message	<p>Querying the most recent error messages</p> <ul style="list-style-type: none"> ■ Command to be transferred ■ Reset user command to default <ul style="list-style-type: none"> ■ Default value: error ■ Indexes Possible indexes between 1 and 32
Clear error message	<p>Clearing the error messages</p> <ul style="list-style-type: none"> ■ Command to be transferred ■ Reset user command to default <ul style="list-style-type: none"> ■ Default value: errorClear ■ Indexes Possible indexes between 1 and 32
Axis position	<p>Reading out the current position</p> <ul style="list-style-type: none"> ■ Command to be transferred Maximum number of characters: 20 ■ Reset user command to default <ul style="list-style-type: none"> ■ Default value: channelPos ■ Indexes Possible indexes between 1 and 3
Axis minimum	<p>Reading out the measured minimum value of the axis</p> <ul style="list-style-type: none"> ■ Command to be transferred Maximum number of characters: 20 ■ Reset user command to default <ul style="list-style-type: none"> ■ Default value: channelMin ■ Indexes Possible indexes between 1 and 3
Axis maximum	<p>Reading out the measured maximum value of the axis</p> <ul style="list-style-type: none"> ■ Command to be transferred Maximum number of characters: 20 ■ Reset user command to default <ul style="list-style-type: none"> ■ Default value: channelMax ■ Indexes Possible indexes between 1 and 3
Axis range	<p>Reading out the measured range of the axis</p> <ul style="list-style-type: none"> ■ Command to be transferred Maximum number of characters: 20 ■ Reset user command to default <ul style="list-style-type: none"> ■ Default value: channelRange ■ Indexes Possible indexes between 1 and 3
Units	<p>Reading out the selected unit (mm/inches)</p> <ul style="list-style-type: none"> ■ Command to be transferred ■ Reset user command to default <ul style="list-style-type: none"> ■ Default value: units

Parameter	Explanation						
Diameter mode active	<p>Reading out the diameter mode state</p> <ul style="list-style-type: none"> ■ Command to be transferred ■ Reset user command to default <ul style="list-style-type: none"> ■ Default value: diameterModeActive ■ Indexes Possible indexes between 1 and 3 ■ Possible states <table border="1"> <thead> <tr> <th>State</th> <th>Description</th> </tr> </thead> <tbody> <tr> <td>True</td> <td>Diameter mode is active in the queried axis</td> </tr> <tr> <td>False</td> <td>Diameter mode is not active in the queried axis</td> </tr> </tbody> </table>	State	Description	True	Diameter mode is active in the queried axis	False	Diameter mode is not active in the queried axis
State	Description						
True	Diameter mode is active in the queried axis						
False	Diameter mode is not active in the queried axis						
Touch probe active	<p>Querying the state of the touch probe</p> <ul style="list-style-type: none"> ■ Command to be transferred ■ Reset user command to default <ul style="list-style-type: none"> ■ Default value: touchProbeActive ■ Possible states <table border="1"> <thead> <tr> <th>State</th> <th>Description</th> </tr> </thead> <tbody> <tr> <td>True</td> <td>The touch probe is connected and activated</td> </tr> <tr> <td>False</td> <td>The touch probe is not activated</td> </tr> </tbody> </table>	State	Description	True	The touch probe is connected and activated	False	The touch probe is not activated
State	Description						
True	The touch probe is connected and activated						
False	The touch probe is not activated						
Measured value output	<p>Setting up the connection for measured value output</p> <ul style="list-style-type: none"> ■ Command to be transferred ■ Reset user command to default <ul style="list-style-type: none"> ■ Default value: mvo 						
Set the preset	<p>Setting the presets</p> <ul style="list-style-type: none"> ■ Command to be transferred ■ Reset user command to default <ul style="list-style-type: none"> ■ Default value: preset ■ Indexes Possible indexes: depending on the number of presets 						
Lock display	<p>Locking the screen</p> <ul style="list-style-type: none"> ■ Command to be transferred ■ Reset user command to default <ul style="list-style-type: none"> ■ Default value: displayLock <div style="border: 1px solid black; padding: 5px; margin-top: 10px;"> <p> You can unlock the screen only on the device itself.</p> </div>						
Shut down	<ul style="list-style-type: none"> ■ Command to be transferred ■ Reset user command to default <ul style="list-style-type: none"> ■ Default value: shutdown 						

Commands for remote access

	RS-232	MQTT	REST
Remote control: Without index	GC/command	Topic: GC/command Msg: Any	GC/command
Example	GC/startREF	Topic: GC/startREF Msg: 1	GC/startREF
With index	GC/command?Index	Topic: GC/command Msg: Index	GC/command?Index
Example	GC/zeroC?1	Topic: GC/zeroC Msg: 1	GC/zeroC?1
Multiple indexes	GC/command?la&lb...	Not possible	GC/command?la&lb...
Example	GC/zeroC?1&3	-	GC/zeroC?1&3
Remote query: Without index	GC/command	Topic: GC/command or GC/#	GC/command
Example	GC/units	Topic: GC/units or GC/#	GC/units

5.3.12 Activating the interface for Data transfer**Settings ► Interfaces ► Data transfer**

Parameter	Explanation
MQTT	Activation of the MQTT protocol
REST	Activation of the REST protocol
RS-232	Selection of the serial interface Settings: <ul style="list-style-type: none"> ■ None ■ X32 Default value: None

Only if serial interface has been selected

The **Standard** and **Steinwald** data formats transfer measured values only when the following axis names are assigned: X, Y, Z, Q, R, D, L, W, A, C, f, Lx, Ly, or Lz.

The minimum, maximum, and range values are transferred only if the axis names X, Y, or Q are assigned.

Parameter	Explanation
Data format for data transfer	<p>Selection of the data format for measured value output</p> <p>Settings:</p> <ul style="list-style-type: none"> ■ Standard ■ Steinwald ■ MyFormat1 (template for copying) ■ Any data formats you have defined yourself <p>Default value: Standard</p>
Data format for touch-probe-triggered data transfer	<p>Selection of the data format for measured value output</p> <p>Settings:</p> <ul style="list-style-type: none"> ■ Standard ■ Steinwald ■ MyFormat1 (template for copying) ■ Any data formats you have defined yourself <p>Default value: Standard</p>
Data format for continuous data transfer	<p>Selection of the data format for measured value output</p> <p>Settings:</p> <ul style="list-style-type: none"> ■ Standard ■ Steinwald ■ MyFormat1 (template for copying) ■ Any data formats you have defined yourself <p>Default value: Standard</p>
Data format for switching-function-triggered data transfer	<p>Selection of the data format for measured value output.</p> <p>You must assign a digital input for the Measured value output switching function.</p> <p>Settings:</p> <ul style="list-style-type: none"> ■ Standard ■ Steinwald ■ MyFormat1 (template for copying) ■ Any data formats you have defined yourself <p>Default value: Standard</p>

5.4 Back up settings

The product's settings can be backed up as a file so that they are available after a reset to the factory default settings has been performed or for installation on multiple units.

Settings ▶ Service ▶ Back up and restore

Parameter	Explanation
Back up settings	Backing up of settings of the product

Performing Complete backup

During a complete backup of the configuration, all settings of the product are backed up.

- ▶ Tap **Complete backup**
- ▶ If required, connect a USB mass storage device (FAT32 format) to a USB port of the product
- ▶ Select the folder to which you want to copy the configuration data
- ▶ Specify a name for the configuration data, e.g. "<yyyy-mm-dd>_config"
- ▶ Confirm the entry with **RET**
- ▶ Tap **Save as**
- ▶ Tap **OK** to confirm the successful backup of the configuration
- > The configuration file has been backed up.

Safely removing a USB mass storage device



- ▶ Tap **File management** in the main menu
- ▶ Navigate to the list of storage locations
- ▶ Tap **Safely remove**
- > The message **The storage medium can be removed now.** appears.
- ▶ Disconnect the USB mass storage device

5.5 Back up user files

The user files of the product can be backed up as a file to make it available after a reset to the factory default settings. This, together with the backing up of the settings, enables you to back up the complete configuration of your product.



All files from all user groups that are stored in the respective folders are backed up and can be restored as user files.

The files in the **System** folder are not restored.

Settings ► Service ► Back up and restore

Parameter	Explanation
Back up user files	Backing up of user files of the product

Performing back up

The user files can be backed up as a ZIP file on a USB mass storage device or connected network drive.

- ▶ Open in succession:
 - **Back up and restore**
 - **Back up user files**
- ▶ Tap **Save as ZIP**
- ▶ If required, connect a USB mass storage device (FAT32 format) to a USB port of the product
- ▶ Select the folder to which you want to copy the ZIP file
- ▶ Enter a name for the ZIP file, e.g., "<yyy-mm-dd>_config"
- ▶ Confirm the entry with **RET**
- ▶ Tap **Save as**
- ▶ Tap **OK** to confirm successful backup of the user files
- > The user files were backed-up.

Safely removing a USB mass storage device



- ▶ Tap **File management** in the main menu
- ▶ Navigate to the list of storage locations
- ▶ Tap **Safely remove**
- > The message **The storage medium can be removed now.** appears.
- ▶ Disconnect the USB mass storage device

6

File Management

6.1 Overview

This chapter describes the **File management** menu and its functions.

i Make sure that you have read and understood the "Basic Operation" chapter before carrying out the actions described below.
Further information: "Basic Operation", Page 19

Short description

The **File management** menu shows an overview of the files stored in the product's memory.

Any connected USB mass storage devices (FAT32 format) or available network drives are shown in the list of storage locations. The USB mass storage devices and the network drives are displayed with their name or drive designation.

Call



- ▶ Tap **File management** in the main menu
- > The file management user interface is displayed.

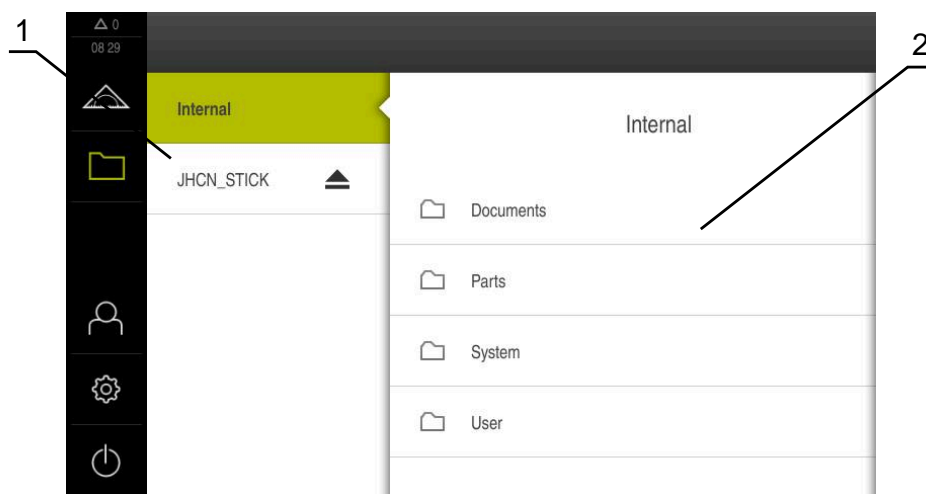

Figure 25: **File management** menu

- 1 List of available storage locations
- 2 List of folders in the selected storage location

6.2 File types

In the **File management** menu you can edit the following file types:



Type	Use	Manage	View	Open	Print
*.mcc	Configuration files	✓	–	–	–
*.dro	Firmware files	✓	–	–	–
*.svg, *.ppm	Image files	✓	–	–	–
*.jpg, *.png, *.bmp	Image files	✓	✓	–	–
*.csv	Text files	✓	–	–	–
*.txt, *.log, *.xml	Text files	✓	✓	–	–
*.pdf	PDF files	✓	✓	–	✓





6.3 Managing folders and files



Folder structure

In the **File management** menu, the files in the **Internal** storage location are saved in the following folders:

Folders	Application
Documents	Document files
System	Audio files and system files
User	User data

Operating element	Function
	<p>Creating a new folder</p> <ul style="list-style-type: none"> ▶ Touch the icon of the folder in which you want to create a new folder, and drag it to the right > The operating elements are displayed. ▶ Tap Create a new folder ▶ Tap the input field in the dialog box and enter a name for the new folder ▶ Confirm your input with RET ▶ Tap OK > A new folder is created.
	<p>Moving a folder</p> <ul style="list-style-type: none"> ▶ Touch the icon of the folder you want to move, and drag it to the right > The operating elements are displayed. ▶ Tap Move to ▶ In the dialog box, select the folder to which you want to move the folder ▶ Tap Select > The folder is moved.

Operating element	Function
	<p>Copying a folder</p> <ul style="list-style-type: none"> ▶ Touch the icon of the folder you want to copy, and drag it to the right > The operating elements are displayed. ▶ Tap Copy to ▶ In the dialog box, select the folder to which you want to copy the folder ▶ Tap Select > The folder is copied.
	<p>Renaming a folder</p> <ul style="list-style-type: none"> ▶ Touch the icon of the folder you want to rename, and drag it to the right > The operating elements are displayed. ▶ Tap Rename folder ▶ Tap the input field in the dialog box and enter a name for the new folder ▶ Confirm your input with RET ▶ Tap OK > The folder is renamed.
	<p>Moving a file</p> <ul style="list-style-type: none"> ▶ Touch the icon of the file you want to move, and drag it to the right > The operating elements are displayed. ▶ Tap Move to ▶ In the dialog box, select the folder to which you want to move the file ▶ Tap Select > The file is moved.
<p> If you move a file into a folder containing a file with the same name, that file is overwritten.</p>	
	<p>Copying a file</p> <ul style="list-style-type: none"> ▶ Touch the icon of the file you want to copy, and drag it to the right > The operating elements are displayed. ▶ Tap Copy to ▶ In the dialog box, select the folder to which you want to copy the file ▶ Tap Select > The file is copied.

Operating element	Function
	<p>Renaming a file</p> <ul style="list-style-type: none"> ▶ Touch the icon of the file you want to rename, and drag it to the right > The operating elements are displayed. ▶ Tap Rename file ▶ Tap the input field in the dialog box and enter a name for the new file ▶ Confirm your input with RET ▶ Tap OK > The file is renamed.
	<p>Deleting a folder or file</p> <p>The folders and files you delete will be permanently deleted and cannot be recovered. If you delete a folder, all subfolders and files contained in that folder will also be deleted.</p> <ul style="list-style-type: none"> ▶ Touch the icon of the folder or file you want to delete, and drag it to the right > The operating elements are displayed. ▶ Tap Delete selection ▶ Tap Delete > The folder or file is deleted.

6.4 Viewing and opening files

Viewing files



- ▶ Tap **File management** in the main menu
- ▶ Navigate to the storage location of the desired file
- ▶ Tap the file
- > A preview image (only with PDF and image files) as well as information about the file are displayed.



Figure 26: **File management** menu with preview image and file information

- ▶ Tap **View**
- > The file contents are displayed.
- ▶ Tap **Close** to close the view



6.5 Exporting files

You can export files to an external USB mass storage device (FAT32 format) or to the network drive. You can either copy or move the files:

- If you copy files, duplicates of the files will remain stored in the product
- If you move files, the files will be deleted in the product



- ▶ Tap **File management** in the main menu
- ▶ In the **Internal** storage location, navigate to the file you want to export
- ▶ Drag the icon of the file to the right
- > The operating elements are displayed.



- ▶ To copy the file, tap **Copy file**



- ▶ To move the file, tap **Move file**
- ▶ In the dialog, select the storage location to which you want to export the file
- ▶ Tap **Select**
- > The file is exported to the USB mass storage device or the network drive.

Safely removing a USB mass storage device



- ▶ Tap **File management** in the main menu
- ▶ Navigate to the list of storage locations



- ▶ Tap **Safely remove**
- > The message **The storage medium can be removed now.** appears.
- ▶ Disconnect the USB mass storage device

6.6 Importing files

You can import files from a USB mass storage device (FAT32 format) or a network drive into the product. You can either copy or move the files:

- If you copy files, duplicates of the files will remain on the USB mass storage device or the network drive
- If you move files, the files will be deleted from the USB mass storage device or the network drive



- ▶ Tap **File management** in the main menu
- ▶ On the USB mass storage device or network drive, navigate to the file you want to import
- ▶ Drag the icon of the file to the right
- > The operating elements are displayed.



- ▶ To copy the file, tap **Copy file**



- ▶ To move the file, tap **Move file**
- ▶ In the dialog, select the storage location to which you want to save the file
- ▶ Tap **Select**
- > The file is stored on the product.

Safely removing a USB mass storage device



- ▶ Tap **File management** in the main menu
- ▶ Navigate to the list of storage locations
- ▶ Tap **Safely remove**
- > The message **The storage medium can be removed now.** appears.
- ▶ Disconnect the USB mass storage device

7

Settings

7.1 Overview

This chapter describes the setting options and the associated settings parameters for the product.

The basic setting options and settings parameters for commissioning and product setup are outlined in the respective chapters:

Further information: "Commissioning", Page 74

Further information: "Setup", Page 122

Short description

 Depending on the type of user that is logged in to the product, settings and settings parameters can be edited and changed (edit permission).
If a user logged in to the product has no edit permission for a setting or a settings parameter, the setting or settings parameter is grayed out and cannot be opened or edited.

Function	Description
General	General settings and information
Sensors	Configuration of sensors and sensor-dependent functions
Interfaces	Configuration of interfaces and network drives
User	Configuration of users
Axes	Configuration of connected encoders and error compensation
Service	Configuration of software options, service functions and information

Calling up



- ▶ Tap **Settings** in the main menu

7.2 General

This chapter describes settings for configuring the operation and display .

Parameter	Further information
Device information	"Device information", Page 160
Screen	"Screen", Page 161
Display	"Display", Page 161
Input devices	"Configuring operation with a mouse or touchscreen", Page 133
Sounds	"Sounds", Page 162
Printers	"Printers", Page 162
Date and time	"Setting the date and time", Page 81
Units	"Setting the units of measure", Page 81
Function bar	"Function bar", Page 163
Copyrights	"Copyrights", Page 163
Service info	"Service info", Page 163
Documentation	"Documentation", Page 163

7.2.1 Device information

Settings ► General ► Device information

The overview displays basic information about the software.

Parameter	Displays the information
Product designation	Product designation of the product
Part number	ID number of the unit
Serial number	Serial number of the product
Firmware version	Version number of the firmware
Firmware built on	Firmware creation date
Last firmware update on	Date of most recent firmware update
Free memory space	Free memory space in the internal storage location Internal
Free working memory (RAM)	Free RAM on the system
Number of unit starts	Number of times the product was started up with the current firmware
Operating time	Operating time of the product with the current firmware

7.2.2 Screen

Settings ► General ► Screen

Parameter	Explanation
Brightness	Brightness of the screen <ul style="list-style-type: none"> ■ Setting range: 1 % ... 100 % ■ Default setting: 85 %
Energy-save-mode timeout	Time until energy-save mode is activated <ul style="list-style-type: none"> ■ Setting range: 0 min ... 120 min If the value is set to 0, the power-saving mode is deactivated ■ Default setting: 30 minutes
Quit the energy saving mode	Required actions to reactivate the screen <ul style="list-style-type: none"> ■ Tap and drag: Touch the touchscreen and drag the arrow upwards from the lower edge ■ Tap: Touch the touchscreen ■ Tap or axis movement: Touch the touchscreen or move the axis ■ Default setting: Tap and drag

7.2.3 Display

Settings ► General ► Display

Parameter	Explanation
Digits before the decimal point for size-adjusted axis display	The number of digits in front of the decimal point indicates the size at which the position values are displayed. If the number of digits in front of the decimal point is exceeded, then the display is reduced in size so that all of the digits can be shown. <ul style="list-style-type: none"> ■ Setting range: 1 ... 6 ■ Default value: 3

7.2.4 Sounds

Settings ► General ► Sounds

The available sounds are grouped into categories. The sounds differ within a category.

Parameter	Explanation
Speaker	Use of the built-in speaker rear panel of the product <ul style="list-style-type: none"> Settings: ON or OFF Default setting: ON
Speaker volume	Volume of the product's speaker <ul style="list-style-type: none"> Setting range: 0 % ... 100 % Default setting: 50 %
Measuring point acquired	Sound to be played after a measuring point was acquired When you select a setting, the associated sound is played <ul style="list-style-type: none"> Settings: Standard, Guitar, Robot, Outer space, No sound Default setting: Standard
Message and Error	Sound to be played when a message is displayed When you select a setting, the associated sound is played <ul style="list-style-type: none"> Settings: Standard, Guitar, Robot, Outer space, No sound Default setting: Standard
Touch tone	Sound to be played when using a touch element When you select a setting, the associated sound is played <ul style="list-style-type: none"> Settings: Standard, Guitar, Robot, Outer space, No sound Default setting: Standard

7.2.5 Printers

Settings ► General ► Printers



The current firmware of the units in this series does not support this function.

7.2.6 Function bar

Settings ► General ► Function bar

Parameter	Explanation
Not all users can configure the function bar	Configuration of function elements <ul style="list-style-type: none"> ■ Settings: ON or OFF ■ Default setting: OFF Further information: "Configuring function elements", Page 39
Load, save and delete not possible for all users	Opening and saving the configuration of function elements, and deletion of function elements <ul style="list-style-type: none"> ■ Settings: ON or OFF ■ Default setting: OFF Further information: "Opening the configuration of function elements", Page 40 Further information: "Saving the configuration of function elements", Page 39 Further information: "Removing a function element from the function bar", Page 38

7.2.7 Copyrights

Settings ► General ► Copyrights

Parameter	Meaning and function
Open source software	Display of the licenses of the software used

7.2.8 Service info

Settings ► General ► Service info

Parameter	Meaning and function
HEIDENHAIN - Customer service	Display of a document containing HEIDENHAIN service addresses
OEM service info	Display of a document containing service information from the machine manufacturer <ul style="list-style-type: none"> ■ Default: document containing HEIDENHAIN service addresses Further information: "Adding documentation", Page 118

7.2.9 Documentation

Settings ► General ► Documentation

Parameter	Meaning and function
Operating Instructions	Display of the operating instructions stored on the product <ul style="list-style-type: none"> ■ Default: no document; the document in the desired language can be added Further information: "Adding the Operating Instructions", Page 130

7.3 Sensors

This chapter describes settings for configuring the sensors.

Parameter	Further information
Touch probe	"Configuring a touch probe", Page 82

7.4 Interfaces

This chapter describes settings for configuring networks, network drives, and USB mass storage devices.

Parameter	Further information
Network	"Configuring the network", Page 131
Network drive	"Configuring the network drive", Page 132
Network protocols	"Network protocols", Page 141
USB	"USB", Page 165
RS-232	"RS-232", Page 134
Data transfer	"Activating the interface for Data transfer", Page 147
Switching functions	"Switching functions", Page 141
Remote commands	"Remote commands", Page 143

7.4.1 USB

Settings ► Interfaces ► USB

Parameter	Explanation
Automatically detect attached USB mass storage devices	Automatic recognition of a USB mass storage device <ul style="list-style-type: none"> ■ Settings: ON or OFF ■ Default setting: ON

7.5 User

This chapter describes settings for configuring users and user groups.

Parameter	Further information
OEM	"OEM", Page 166
Setup	"Setup", Page 166
Operator	"Operator", Page 167
Adding a User	"Creating a user and password", Page 129

7.5.1 OEM

Settings ► User ► OEM

The **OEM** (Original Equipment Manufacturer) user has the highest level of permissions. This user is allowed to configure the product's hardware (e.g. connection of encoders and sensors). He can create **Setup** and **Operator**-type users, and configure the **Setup** and **Operator** users. The **OEM** user cannot be duplicated or deleted. This user cannot be logged in automatically.

Parameters	Explanation	Edit permission
Name	Name of the user ■ Default value: OEM	–
First name	First name of the user ■ Default value: –	–
Department	Department of the user ■ Default value: –	–
Group	Group of the user ■ Default value: oem	–
Password	Password of the user ■ Default value: oem	OEM
Language	Language of the user	OEM
Auto login	On restart of the product: Automatic login of the last logged-in user ■ Default value: OFF	–
Remove user account	Removal of the user account	–

7.5.2 Setup

Settings ► User ► Setup

The **Setup** user configures the product for use at the place of operation. This user can create **Operator**-type users. The **Setup** user cannot be duplicated or deleted. This user cannot be logged in automatically.

Parameters	Explanation	Edit permission
Name	Name of the user ■ Default value: Setup	–
First name	First name of the user ■ Default value: –	–

Parameters	Explanation	Edit permission
Department	Department of the user ■ Default value: –	–
Group	Group of the user ■ Default value: setup	–
Password	Password of the user ■ Default value: setup	Setup, OEM
Language	Language of the user	Setup, OEM
Auto login	On restart of the product: Automatic login of the last logged-in user ■ Default value: OFF	–
Remove user account	Removal of the user account	–

7.5.3 Operator

Settings ► User ► Operator

The **Operator** user is permitted to use the basic functions of the product. An **Operator**-type user cannot create additional users, but is allowed to edit various operator-specific settings, such as his name or the language. A user of the **Operator** group can be logged in automatically as soon as the product is switched on.

Parameters	Explanation	Edit permission
Name	Name of the user ■ Default value: Operator	Operator, Setup, OEM
First name	First name of the user	Operator, Setup, OEM
Department	Department of the user ■ Default value: –	Operator, Setup, OEM
Group	Group of the user ■ Default value: operator	–
Password	Password of the user ■ Default value: operator	Operator, Setup, OEM
Language	Language of the user	Operator, Setup, OEM
Auto login	On restart of the product: Automatic login of the last logged-in user ■ Settings: ON or OFF ■ Default value: OFF	Operator, Setup, OEM
Remove user account	Removal of the user account	Setup, OEM

7.6 Axes

This chapter describes settings for configuring the axes and assigned devices.



Not all of the described parameters and options may be available, depending on the product version, configuration and the connected encoders.

General settings

Settings ► Axes ► General settings

Parameter	Further information
Reference marks	"Reference marks", Page 116
Information	"Information", Page 169
Switching functions	"Switching functions", Page 141
Error compensation	"Performing error compensation", Page 97
Nonlinear error compensation (NLEC)	"Configuring the Nonlinear error compensation (NLEC)", Page 101
Squareness error compensation (SEC)	"Configuring Squareness error compensation (SEC)", Page 114
Alias assignment for axis names	"Configuring Alias assignment for axis names", Page 83

Axis-specific settings

Settings ► Axes ► <Axis name> (settings of the axis)

Parameter	Further information
<Axis name> (settings of the axis)	"Configuring the axes", Page 83
Encoder	"Configuring axes for encoders with EnDat interface", Page 87 "Configuring the axes for encoders with a 1 V _{PP} or 11 μA _{PP} interface", Page 88 "Configuring axes for encoders with TTL interface", Page 93
Reference marks (Encoder)	1 V _{PP} : "Reference marks (Encoder)", Page 91 TTL: "Reference marks (Encoder)", Page 91
Reference point displacement	EnDat: "Reference point displacement", Page 88 1 V _{PP} : "Reference point displacement", Page 88 TTL: "Reference point displacement", Page 88
Diagnostics for encoders with EnDat	"Diagnostics for encoders with EnDat interface", Page 178
Diagnostics for encoders with 1 V _{PP} /11 μA _{PP}	"Diagnostics for encoders with 1 V _{PP} /11 μA _{PP} interface", Page 177
Linear error compensation (LEC)	"Configuring linear error compensation (LEC)", Page 98
Segmented linear error compensation (SLEC)	"Configuring segmented linear error compensation (SLEC)", Page 99
Create table of supporting points	"Create table of supporting points", Page 100

7.6.1 Information

Settings ► Axes ► General settings ► Information

Parameters	Explanation
Assignment of the encoder inputs to the axes	Shows the assignment of the encoder inputs to the axes
Assignment of the analog outputs to the axes	Shows the assignment of the analog outputs to the axes
Assignment of the analog inputs to the axes	Shows the assignment of the analog inputs to the axes
Assignment of the digital outputs to the axes	Shows the assignment of the digital outputs to the axes
Assignment of the digital inputs to the axes	Shows the assignment of the digital inputs to the axes



With the **Reset** buttons, the assignments for the inputs and outputs can be reset.

7.7 Service

This chapter describes settings for product configuration, for maintaining the firmware and for enabling software options.

Parameter	Further information
Firmware information	"Firmware information", Page 171
Back up and restore	"Back up settings", Page 120 "Back up user files", Page 121 "Restore user files", Page 182 "Restoring settings", Page 183
Firmware update	"Updating the firmware", Page 175
Reset	"Reset all settings", Page 184 "Reset to shipping conditions", Page 184
OEM area	"OEM area", Page 117
Documentation (OEM service info)	"Adding documentation", Page 118
Startup screen	"Adding a startup screen", Page 118
Documentation	"Adding the Operating Instructions", Page 130
Software options	"Activating Software options", Page 78

7.7.1 Firmware information

Settings ► Service ► Firmware information

The following information on the individual software modules is displayed for service and maintenance.

Parameter	Explanation
Core version	Version number of the microkernel
Microblaze bootloader version	Version number of the Microblaze bootloader
Microblaze firmware version	Version number of the Microblaze firmware
Extension PCB bootloader version	Version number of the bootloader (expansion board)
Extension PCB firmware version	Version number of the firmware (expansion board)
Boot ID	ID number of the boot process
HW Revision	Revision number of the hardware
C Library Version	Version number of the C library
Compiler Version	Version number of the compiler
Touchscreen Controller version	Version number of the touchscreen controller
Qt build system	Version number of the Qt compilation software
Qt runtime libraries	Version number of the Qt runtime libraries
Kernel	Version number of the Linux kernel
Login status	Information on the logged-in user
SystemInterface	Version number of the system interface module
BackendInterface	Version number of the backend interface module
GuiInterface	Version number of the user interface module
TextDataBank	Version number of the text database module
Optical edge detection	Version number of the optical edge detection module
NetworkInterface	Version number of the network interface module
OSInterface	Version number of the operating system interface module
Metrology	Version number of the metrology module
PrinterInterface	Version number of the printer interface module
Programming	Version number of the programming module
system.xml	Version number of the system parameters
axes.xml	Version number of the axis parameters
encoders.xml	Version number of the encoder parameters
ncParam.xml	Version number of the NC parameters
io.xml	Version number of the parameters for inputs and outputs
opticalEdge.xml	Version number of the parameters for OED
peripherals.xml	Version number of the parameters for peripherals
slec.xml	Version number of the parameters for segmented linear error compensation (SLEC)
lec.xml	Version number of the parameters for linear error compensation (LEC)

Parameter	Explanation
nlec.xml	Version number of the parameters for nonlinear error compensation (NLEC)
microBlazePVRegister.xml	Version number of the "Processor Version Register" of MicroBlaze
info.xml	Version number of the information parameters
audio.xml	Version number of the audio parameters
network.xml	Version number of the network parameters
metrology.xml	Metrology parameters
os.xml	Version number of the operating system parameters
runtime.xml	Version number of the runtime parameters
serialPort.xml	Version number of the parameters of the serial interface
users.xml	Version number of the user parameters
GI Patch Level	Patch level of the golden image (GI)

8

**Servicing and
Maintenance**

8.1 Overview

This chapter describes the general maintenance work on the product.

 The following steps must be performed only by qualified personnel.
Further information: "Personnel qualification", Page 16

 This chapter contains a description of maintenance work for the product only. Any maintenance work on peripheral devices is not described in this chapter.
Further information: Manufacturer's documentation for the respective peripheral devices

8.2 Cleaning

NOTICE

Cleaning with sharp-edged objects or aggressive cleaning agents

Improper cleaning will cause damage to the product.

- ▶ Never use abrasive or aggressive cleaners, and never use strong detergents or solvents
- ▶ Do not use sharp-edged objects to remove persistent contamination

Cleaning the housing

- ▶ Use only a cloth dampened with water and a mild detergent for cleaning the exterior surfaces

Cleaning the screen

Activate cleaning mode to clean the display. This switches the unit to an inactive state without interrupting the power supply. The screen is switched off in this state.



- ▶ Tap **Switch-off** in the main menu to activate the cleaning mode



- ▶ Tap **Cleaning mode**
- > The screen switches off.
- ▶ Use a lint-free cloth and a commercially available glass cleaner to clean the screen



- ▶ To deactivate the cleaning mode, tap anywhere on the touchscreen
- > An arrow appears at the bottom of the screen.
- ▶ Drag the arrow up
- > The screen is switched on and shows the user interface last displayed.

8.3 Maintenance plan

The product is largely maintenance-free.

NOTICE
<p>Operating defective devices</p> <p>Operating defective devices may result in serious consequential damage.</p> <ul style="list-style-type: none"> ▶ Do not repair or operate the device if it is damaged ▶ Replace defective devices immediately or contact a HEIDENHAIN service agency

	<p>The following steps are only to be performed by electrical specialists.</p> <p>Further information: "Personnel qualification", Page 16</p>
---	--

Maintenance step	Interval	Corrective action
▶ All labels and symbols provided on the product must be checked for readability	Annually	▶ Contact HEIDENHAIN service agency
▶ Inspect electrical connections for damage and check their function	Annually	▶ Replace defective cables. Contact HEIDENHAIN service agency if required
▶ Check power cables for faulty insulation and weak points	Annually	▶ Replace power cables according to the specification

8.4 Resuming operation

When operation is resumed, for example when the product is reinstalled after repair or when it is remounted, the same measures and personnel requirements apply as for mounting and installing the product.

Further information: "Mounting", Page 56

Further information: "Installation", Page 62

When connecting the peripheral devices (e.g., encoders), the operating company must ensure safe resumption of operation and assign authorized and appropriately qualified personnel to the task.

Further information: "Obligations of the operating company", Page 16

8.5 Updating the firmware

The firmware is the operating system of the product. You can import new versions of the firmware via the product's USB port or the network connection.

	<p>Prior to the firmware update, you must comply with the release notes for the respective software version and the information they contain regarding reverse compatibility.</p>
---	---

	<p>In order to be on the safe side, the current settings must be backed up if the unit's firmware is going to be updated.</p>
---	---

Prerequisite

- The new firmware is available as a *.dro file
- To update the firmware over the USB port, the current firmware must be stored on a USB mass storage device (FAT32 format)
- To update the firmware via the network interface, the current firmware must be available in a folder on the network drive

Starting a firmware update



- ▶ Tap **Settings** in the main menu
- ▶ Tap **Service**
- ▶ Open in succession:
 - **Firmware update**
 - **Continue**
- > The service application is launched.

Updating the firmware

The firmware can be updated from a USB mass storage device (FAT32 format) or via a network drive.



- ▶ Tap **Firmware update**
- ▶ Tap **Select**
- ▶ If required, connect a USB mass storage device to a USB port of the product
- ▶ Navigate to the folder containing the new firmware



If you have accidentally tapped the wrong folder, you can return to the previous folder.

- ▶ Tap the file name that is displayed above the list

- ▶ Select the firmware
- ▶ Tap **Select** to confirm the selection
- > The firmware version information is displayed.
- ▶ Tap **OK** to close the dialog



The firmware update cannot be canceled once the data transfer has started.

- ▶ Tap **Start** to start the update
- > The screen shows the progress of the update.
- ▶ Tap **OK** to confirm successful update
- ▶ Tap **Finish** to terminate the service application
- > The service application is terminated.
- > The main application is launched.
- > If automatic user login is active, the user interface is displayed in the **Measure** menu.
- > If automatic user login is not active, the **User login** menu is displayed.

Safely removing a USB mass storage device



▶ Tap **File management** in the main menu

▶ Navigate to the list of storage locations



▶ Tap **Safely remove**

▶ The message **The storage medium can be removed now.** appears.

▶ Disconnect the USB mass storage device

8.6 Encoder diagnostics

The diagnostic function allows you to perform a basic functional check of the encoders. For absolute encoders with EnDat interface, the messages from the encoder and its functional reserves are displayed. For incremental encoders with 1 V_{PP} or 11 μA_{PP} interface, the displayed values allow you to evaluate the fundamental functioning of the encoders. Based on this initial diagnostic option for encoders, you can initiate further actions for more detailed testing or repair.



The PWT 101 or PWM 21 from HEIDENHAIN provides further inspection and testing capabilities.

For more information, please refer to www.heidenhain.com.

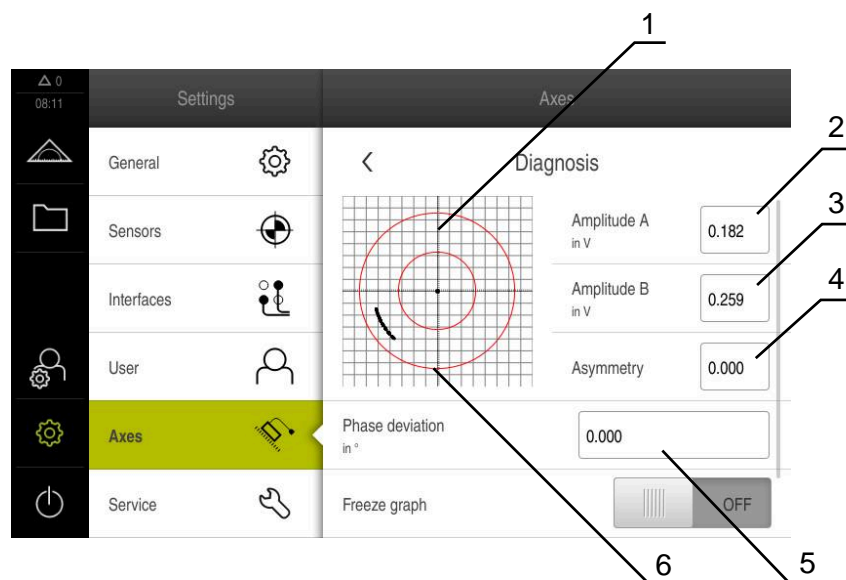

8.6.1 Diagnostics for encoders with 1 V_{PP}/11 μA_{PP} interface

For encoders with 1 V_{PP}/11 μA_{PP} interface, you can evaluate the functioning of the encoder based on the signal amplitudes, asymmetry, and phase deviation. These values are also displayed graphically as a Lissajous figure.



- 1 Lissajous figure
- 2 Amplitude A
- 3 Amplitude B
- 4 Asymmetry
- 5 Phase deviation
- 6 Amplitude tolerances

Settings ▶ Axes ▶ <Axis name> ▶ Encoder ▶ Diagnosis

Parameter	Explanation
Amplitude A	Display of amplitude A in volts (V)
Amplitude B	Display of amplitude B in volts (V)
Asymmetry	Asymmetry value
Phase deviation	Phase deviation from 90°
Freeze graph	Freezing of Lissajous figure Settings: <ul style="list-style-type: none"> ■ ON: The graph is frozen and is not updated when the encoder is moved ■ OFF: The graph is not frozen and is updated when the encoder is moved ■ Default value: OFF
Show tolerance range	Display of tolerance circles in a range from 0.6 V to 1.2 V Settings: <ul style="list-style-type: none"> ■ ON: Two red circles are shown ■ OFF: Tolerance circles are hidden ■ Default value: OFF
Encoder input for comparative measurement	Display of another encoder at another encoder input for comparative measurement; the Freeze graph parameter allows you to superimpose the circles Settings: <ul style="list-style-type: none"> ■ Selection of desired encoder input ■ Default value: Not connected <div style="border: 1px solid black; padding: 5px; margin-top: 10px;"> <p> The parameter is available only if another encoder with 1 V_{PP} or 11 μA_{PP} interface is connected.</p> </div>
Freeze comparative graph	The Lissajous figure of the encoder at the encoder input is frozen for comparative measurement Settings: <ul style="list-style-type: none"> ■ ON: The graph is frozen and is not updated when the encoder is moved ■ OFF: The graph is not frozen and is updated when the encoder is moved ■ Default value: OFF <div style="border: 1px solid black; padding: 5px; margin-top: 10px;"> <p> The parameter is available only if another encoder with 1 V_{PP} or 11 μA_{PP} interface is connected.</p> </div>

8.6.2 Diagnostics for encoders with EnDat interface

You can check the encoders with EnDat interface for proper functioning by reading out the errors or warnings and by evaluating their functional reserves.

Depending on the encoder, not all of the functional reserves and messages are supported.

Functional reserves

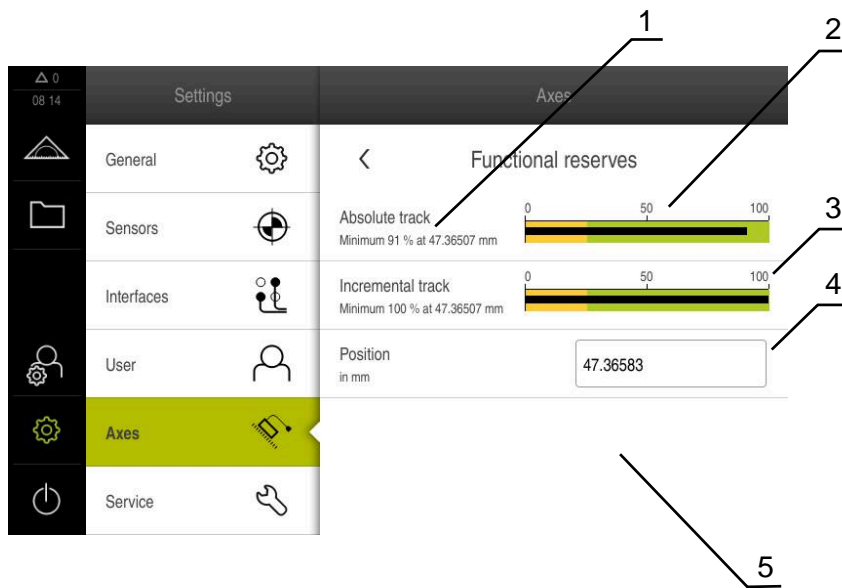

Figure 27: Example of functional reserves of a length gauge

- 1 Minimum percentage value of functional reserves at this specific position
- 2 Absolute track
- 3 Incremental track
- 4 Position value calculation
- 5 Current position of encoder

Path: **Settings ► Axes ► <Axis name> ► Encoder ► Diagnosis Functional reserves**

Parameter	Explanation
Absolute track	Displays the functional reserves of the absolute track
Incremental track	Displays the functional reserves of the incremental track
Position value calculation	Displays the functional reserves of position value calculation
Position	Displays the actual current position of the encoder

The product displays the functional reserves in a bar graph:

Color	Range	Evaluation
Yellow	0 % ... 25 %	Servicing/maintenance recommended; testing recommended (e.g., with PWT 101)
Green	25 % ... 100%	The encoder is within the specification

Errors and warnings

Settings ► Axes ► <Axis name> ► Encoder ► Diagnosis

Message	Description
Encoder error	Encoder errors indicate a malfunction of the encoder Examples of encoder errors that may be displayed: <ul style="list-style-type: none"> ■ Failure of the light unit ■ Incorrect signal amplitude ■ Incorrect position ■ Overvoltage ■ Undervoltage supply ■ Overcurrent ■ Battery failure
Encoder warning	Encoder warnings indicate that certain tolerance limits of the encoder have been reached or exceeded Examples of encoder warnings that may be displayed: <ul style="list-style-type: none"> ■ Frequency collision ■ Temperature exceedance ■ Light-source control reserve ■ Battery charge ■ Reference point

The messages can have the following status:

Status	Evaluation
OK!	The encoder is within the specification
Not supported	Message not supported by the encoder
Error!	Servicing/maintenance recommended; detailed analyses recommended (e.g., with PWT 101)

8.7 Restoring files and settings

You can restore saved files and settings to a device.

The following sequence should be followed when restoring files and settings:

- Restore OEM-specific folders and files
- Restore user files
- Restoring settings

An automatic restart of the product is performed only after the settings have been restored.

8.7.1 Restore OEM-specific folders and files

Backed-up OEM-specific folders and files of the product can be loaded onto a device. This allows you to restore the configuration of a device while restoring the settings.

Further information: "Restoring settings", Page 183

If servicing becomes necessary, an exchange unit can thus be operated with the configuration of the failed unit once the settings have been restored, provided that both units use the same or compatible firmware versions.

Settings ▶ Service ▶ OEM area ▶ Back up and restore

Parameter	Explanation
Restore OEM specific folders and files	Restoring the settings of the OEM area as a ZIP file

- ▶ **Restore OEM specific folders and files**
- ▶ Tap **Load as ZIP**
- ▶ If required, connect a USB mass storage device (FAT32 format) to a USB port of the product
- ▶ Navigate to the folder containing the backup file
- ▶ Select the backup file
- ▶ Tap **Select**
- ▶ Confirm the successful transfer with **OK**



There is no automatic restart when the OEM-specific folders and files are restored. A restart is performed when the settings are restored.

Further information: "Restoring settings", Page 183

- ▶ To restart the product with the transferred OEM-specific folders and files, switch the product off and then back on

Safely removing a USB mass storage device



- ▶ Tap **File management** in the main menu
- ▶ Navigate to the list of storage locations
- ▶ Tap **Safely remove**
- ▶ The message **The storage medium can be removed now.** appears.
- ▶ Disconnect the USB mass storage device



8.7.2 Restore user files

Backed-up user files of the product can be loaded into the product again. Existing user files will be overwritten. This, together with the restoring of the settings, enables you to restore the complete configuration of a unit.

If servicing becomes necessary, a replacement unit can be operated with the configuration of the failed unit after restoring. This requires that the version of the old firmware matches that of the new firmware or that the versions are compatible.

 All files from all user groups that are stored in the respective folders are backed up and can be restored as user files.
The files in the **System** folder are not restored.

Settings ▶ Service ▶ Back up and restore

Parameter	Explanation
Restore user files	Restoring of user files of the product

- ▶ **Restore user files**
- ▶ Tap **Load as ZIP**
- ▶ If required, connect a USB mass storage device (FAT32 format) to a USB port of the product
- ▶ Navigate to the folder containing the backup file
- ▶ Select the backup file
- ▶ Tap **Select**
- ▶ Confirm the successful transfer with **OK**

 There is no automatic restart when the user files are restored. A restart is performed when the settings are restored.
"Restoring settings"

- ▶ To restart the product with the transferred user files, switch the product off and then back on

Safely removing a USB mass storage device



- ▶ Tap **File management** in the main menu
- ▶ Navigate to the list of storage locations
- ▶ Tap **Safely remove**
- ▶ The message **The storage medium can be removed now.** appears.
- ▶ Disconnect the USB mass storage device



8.7.3 Restoring settings

Backed-up settings can be restored to the product. The current configuration of the product is replaced in the process.



Software options that were active when the settings were backed up must be activated before restoring the settings.

A restore can be necessary in the following cases:

- During commissioning, the settings are set on a product and transferred to all identical products
Further information: "Steps for commissioning", Page 77
- After a reset, the settings are copied back to the product
Further information: "Reset all settings", Page 184

Settings ▶ Service ▶ Back up and restore

Parameter	Explanation
Restoring settings	Restoring of the backed up settings

- ▶ **Restoring settings**
- ▶ Tap **Complete restoration**
- ▶ If required, connect a USB mass storage device (FAT32 format) to a USB port on the product
- ▶ Navigate to the folder containing the backup file
- ▶ Select the backup file
- ▶ Tap **Select**
- ▶ Confirm the successful transfer with **OK**
- > The system is shut down
- ▶ To restart the product with the transferred configuration data, switch the product off and then back on

Safely removing a USB mass storage device



- ▶ Tap **File management** in the main menu
- ▶ Navigate to the list of storage locations
- ▶ Tap **Safely remove**
- > The message **The storage medium can be removed now.** appears.
- ▶ Disconnect the USB mass storage device



8.8 Reset all settings

You can reset the settings of the product to the factory defaults if required. The software options are deactivated and must be subsequently reactivated with the available license key.

Settings ► Service ► Reset

Parameter	Explanation
Reset all settings	The settings are reset to factory default settings

- ▶ **Reset all settings**
- ▶ Enter password
- ▶ Confirm entry with **RET**
- ▶ To show the password in plain text, activate **Show password**
- ▶ Tap **OK** to confirm the action
- ▶ Tap **OK** to confirm the reset
- ▶ Tap **OK** to confirm shutdown of the product
- > The device is being shut down.
- > All settings are reset.
- > To restart the product, switch it off and then back on.

8.9 Reset to shipping conditions

You can reset the settings of the product to the factory defaults and delete the user files from product's memory area. The software options are deactivated and must be subsequently reactivated with the available license key.

Settings ► Service ► Reset

Parameter	Explanation
Reset to shipping conditions	Resetting of the settings to the factory default setting and deletion of the user files from the unit's memory area

- ▶ **Reset to shipping conditions**
- ▶ Enter password
- ▶ Confirm entry with **RET**
- ▶ To show the password in plain text, activate **Show password**
- ▶ Tap **OK** to confirm the action
- ▶ Tap **OK** to confirm the reset
- ▶ Tap **OK** to confirm shutdown of the device
- > The device is being shut down.
- > All settings are reset and the user files are deleted.
- > To restart the product, switch it off and then back on.

9

Removal and Disposal

9.1 Overview

This chapter contains information and environmental protection specifications that must be observed for correct disassembly and disposal of the device.

9.2 Removal



Removal of the product must be performed only by qualified personnel.

Further information: "Personnel qualification", Page 16

Depending on the connected peripherals, the removal may need to be performed by an electrical specialist.

In addition, the same safety precautions that apply to the mounting and installation of the respective components must be taken.

Removing the product

To remove the product, follow the installation and mounting steps in the reverse order.

Further information: "Installation", Page 62

Further information: "Mounting", Page 56

9.3 Disposal



NOTICE

Incorrect disposal of the product!

Incorrect disposal of the product can cause environmental damage.

- ▶ Do not dispose of electrical waste and electronic components in domestic waste
- ▶ The integrated backup battery must be disposed of separately from the product
- ▶ Forward the product and the backup battery to recycling in accordance with the applicable local disposal regulations

- ▶ If you have any questions about the disposal of the product, please contact a HEIDENHAIN service agency

10

Specifications

10.1 Overview

This chapter contains an overview of the product data and drawings with the product dimensions and mating dimensions.

10.2 Product data

Device	
Housing	Aluminum cast housing
Housing dimensions	200 mm x 169 mm x 41 mm For devices with ID 1089182-xx: 200 mm x 169 mm x 47 mm
Fastener system, mating dimensions	Mounting hole pattern 50 mm x 50 mm
Display	
Visual display unit	<ul style="list-style-type: none"> ■ LCD widescreen (15:9) color screen 17.8 cm (7") ■ 800 x 480 pixels
Display step	Selectable, min. 0.00001 mm
User interface	User interface (GUI) with touchscreen
Electrical data	
Supply voltage	<ul style="list-style-type: none"> ■ AC 100 V ... 240 V ($\pm 10\%$) ■ 50 Hz ... 60 Hz ($\pm 5\%$) ■ Max. input power 38 W
Buffer battery	Lithium battery type CR2032; 3.0 V
Overtoltage category	II
Number of encoder inputs	3
Encoder interfaces	<ul style="list-style-type: none"> ■ For devices with ID 1089181-01, 1089181-03, 1089182-01: 1 V_{PP}: maximum current 300 mA, max. input frequency 400 kHz ■ For devices with ID 1089181-01, 1089181-03, 1089182-01: 11 μA_{PP}: maximum current 300 mA, max. input frequency 150 kHz ■ For devices with ID 1089181-01, 1089181-03, 1089182-01: EnDat 2.2: maximum current 300 mA ■ For devices with ID 1089181-02, 1089181-03: TTL: maximum current 300 mA, max. input frequency 5 MHz
Interpolation at 1 V _{PP}	4096-fold

Electrical data

Touch probe connection	<ul style="list-style-type: none"> ■ Voltage supply DC 5 V or DC 12 V ■ 5 V or floating switching output ■ Four digital inputs: TTL DC 0 V to +5 V low-active ■ One digital output TTL DC 0 V to +5 V Maximum load 1 kΩ ■ Max. cable length with HEIDENHAIN cable 30 m
------------------------	---

Digital inputs	For devices with ID 1089182-xx:		
	Level	Voltage range	Current range
	High	DC 11 V ... 30 V	2.1 mA ... 6.0 mA
	Low	DC 3 V ... 2.2 V	0.43 mA

Digital outputs	For devices with ID 1089182-xx: Voltage range DC 24 V (20.4 V ... 28.8 V) Output current max. 150 mA per channel
-----------------	--

Relay outputs	For devices with ID 1089182-xx: <ul style="list-style-type: none"> ■ Max. switching voltage AC 30 V / DC 30 V ■ Max. switching current 0.5 A ■ Max. switching capacity 15 W ■ Max. continuous current 0.5 A
---------------	---

Analog inputs	For devices with ID 1089182-xx: Voltage range DC 0 V ... +5 V Resistance 100 Ω \leq R \leq 50 k Ω
---------------	---

Analog outputs	For devices with ID 1089182-xx: Voltage range DC -10 V ... +10 V Maximum load 1 k Ω
----------------	--

5 V voltage outputs	For devices with ID 1089182-xx: Voltage tolerance \pm 5 %, maximum current 100 mA
---------------------	--

Data interface	<ul style="list-style-type: none"> ■ 1 USB 2.0 Hi-Speed (Type A), maximum current 500 mA ■ 1 Ethernet 10/100 Mbit/1 Gbit (RJ45)
----------------	---

Environment

Operating temperature	0 °C to +45 °C
Storage temperature	-20 °C to +70 °C
Relative air humidity	10 % to 80 % RH, non-condensing
Altitude	\leq 2000 m

General information

Directives	<ul style="list-style-type: none"> ■ EMC Directive 2014/30/EU ■ Low Voltage Directive 2014/35/EU ■ RoHS Directive 2011/65/EU
Pollution degree	2

General information

Protection EN 60529	<ul style="list-style-type: none"> ■ Front panel and side panels: IP 65 ■ Rear panel: IP 40
---------------------	---

Mass	<ul style="list-style-type: none"> ■ 1.3 kg ■ With Single-Pos stand: 1.35 kg ■ With Duo-Pos stand 1.45 kg ■ With Multi-Pos stand: 1.95 kg ■ With Multi-Pos holder: 1.65 kg
	For devices with ID 1089182-xx:
	<ul style="list-style-type: none"> ■ 1.5 kg ■ With Single-Pos stand: 1.55 kg ■ With Duo-Pos stand 1.65 kg ■ With Multi-Pos stand: 2.15 kg ■ With Multi-Pos holder: 1.85 kg

10.3 Product dimensions and mating dimensions

All dimensions in the drawings are in millimeters.

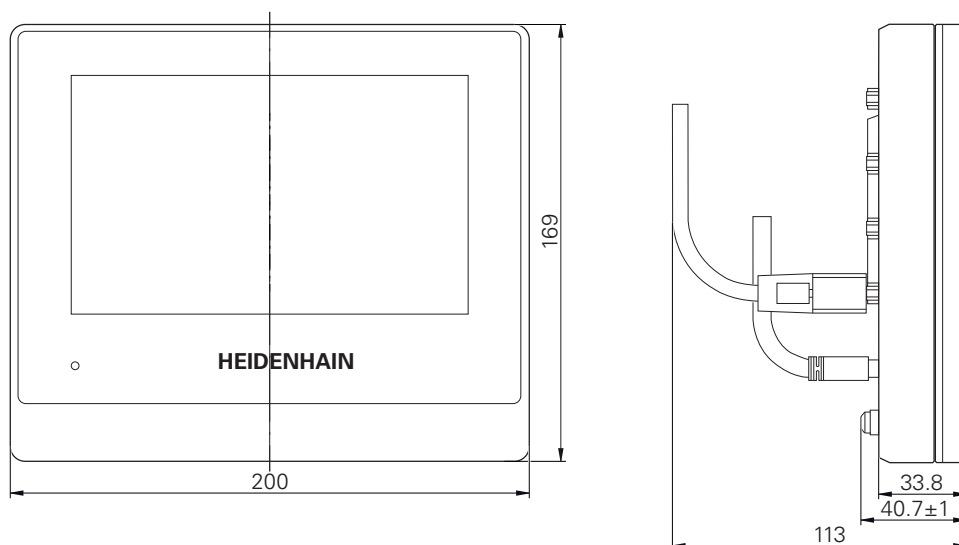

Figure 28: Housing dimensions for devices with ID 1089181-xx

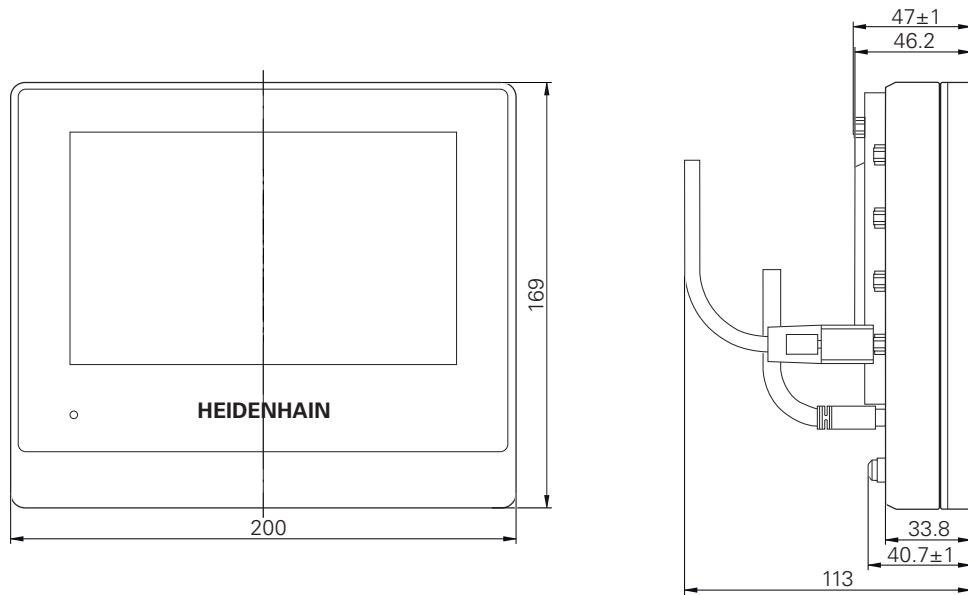

Figure 29: Housing dimensions for devices with ID 1089182-xx

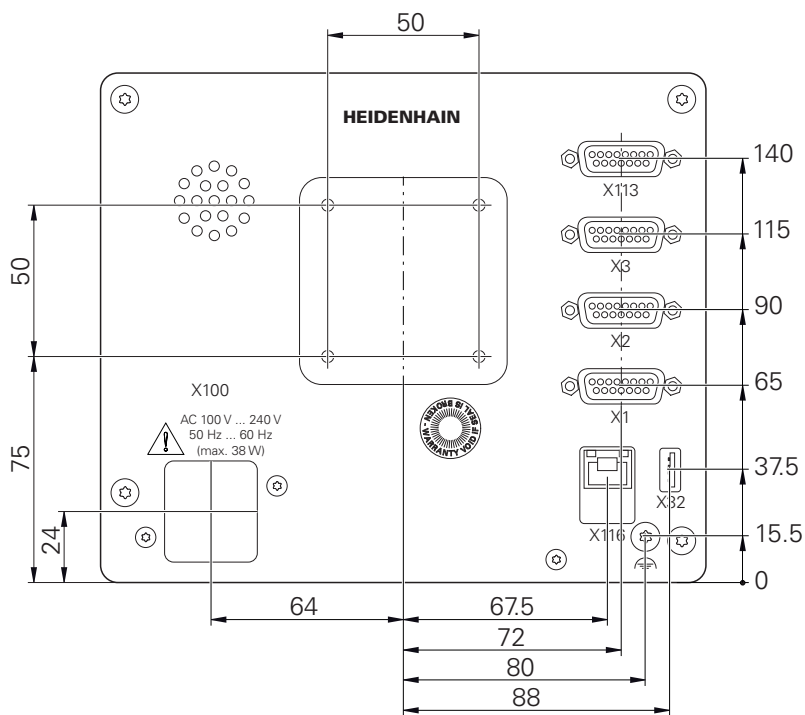

Figure 30: Dimensions of the rear panel for devices with ID 1089181-xx

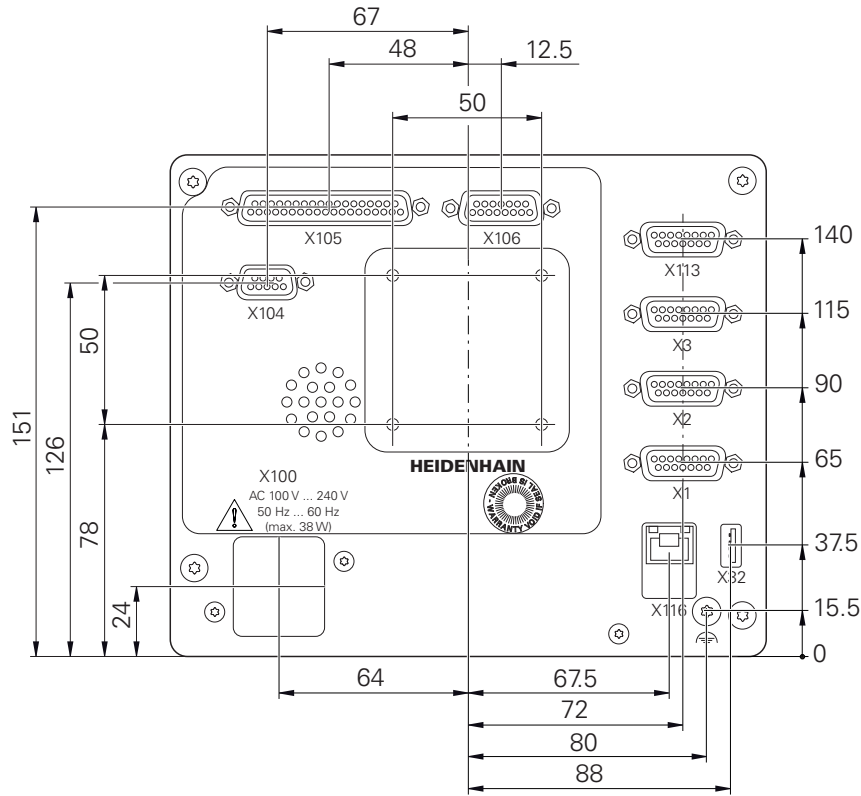

Figure 31: Housing dimensions of the rear panel for devices with ID 1089182-xx

10.3.1 Product dimensions with Single-Pos stand

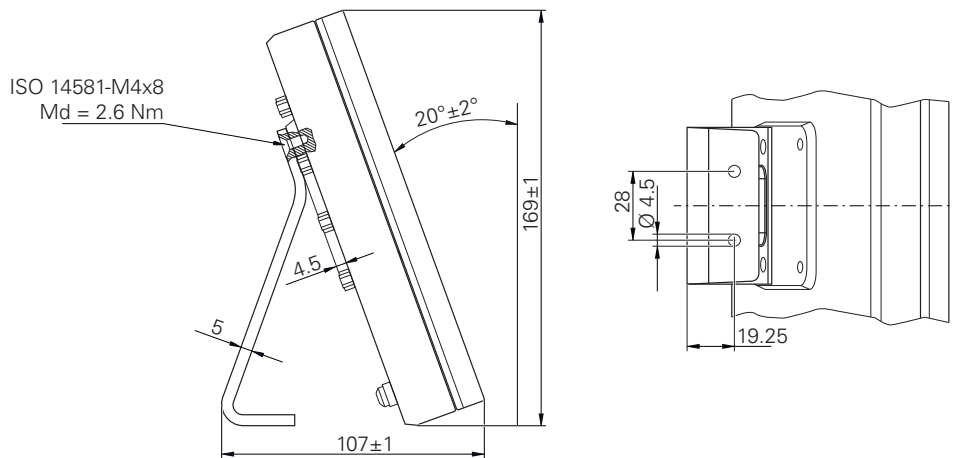

Figure 32: Product dimensions with Single-Pos stand

10.3.2 Product dimensions with Duo-Pos stand

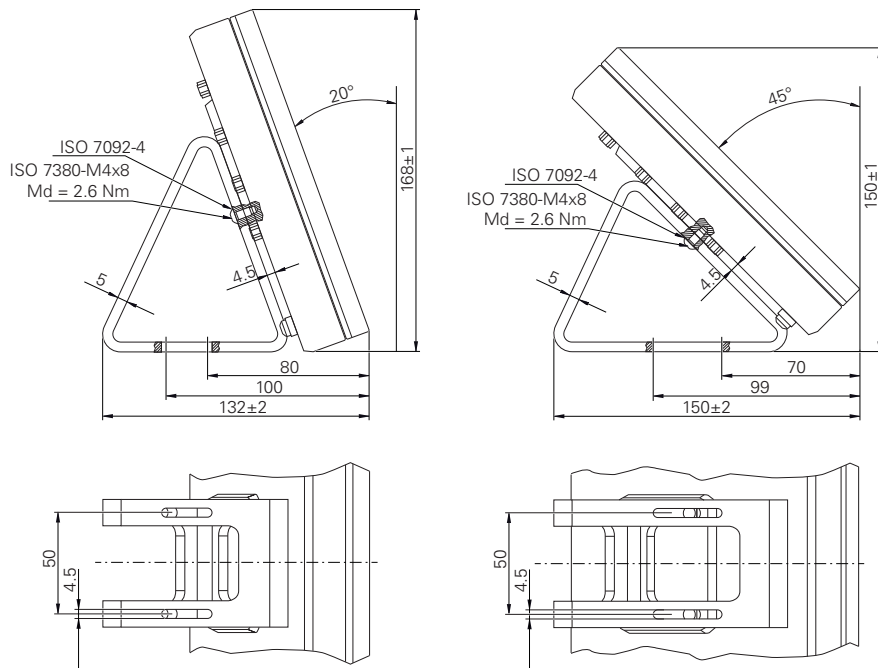

Figure 33: Product dimensions with Duo-Pos stand

10.3.3 Product dimensions with Multi-Pos stand

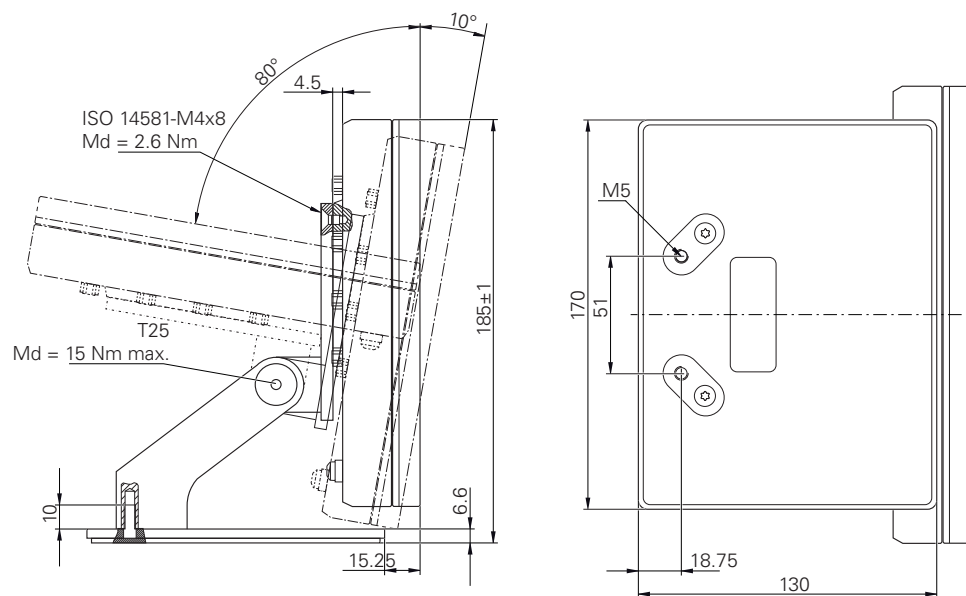

Figure 34: Product dimensions with Multi-Pos stand

10.3.4 Product dimensions with Multi-Pos holder

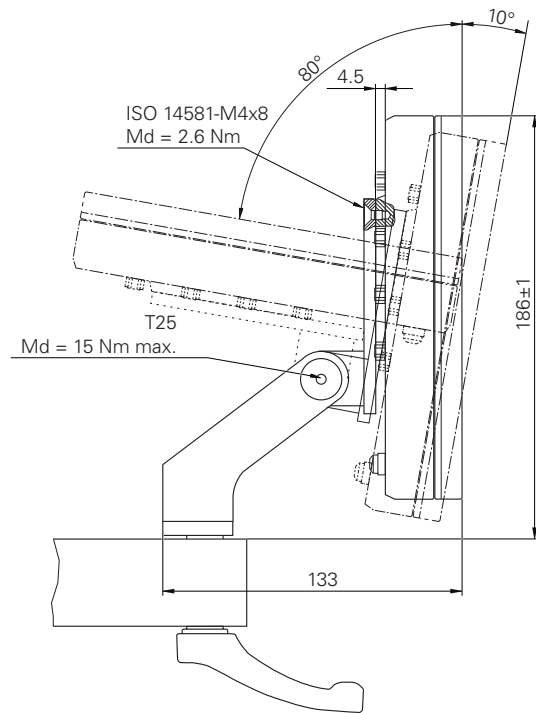

Figure 35: Product dimensions with Multi-Pos holder



**Information for the
Operator**

Overview

This part of the documentation provides the information needed by the users of the Operator type in order to operate the product.

The methods for capturing the measuring points and positioning the axes depend on the respective machine on which GAGE CHEK 2000 is used. A general description follows below.



Make sure that you have read and understood the "Basic Operation" chapter before carrying out the actions described below.

Further information: "Basic Operation", Page 19

Contents of chapters in the "Information for the Operator" part

The table below shows:

- The chapters included in this "Information for the Operator" part
- The information contained in these chapters
- The target groups that these chapters are mainly intended for

Section	Contents	Target group		
		OEM	Setup	Operator
This chapter contains information about...				
1 "Preparing a measurement"	... the preparation of a measurement		✓	✓
2 "Preset"	... the creation of a preset table ... the selection of presets		✓	✓
3 "Lengths and angles"	... the reading of measured values		✓	✓
5 "Probing functions"	... the configuration of the function element ... the performance of a measurement		✓	✓
6 "Minimum, maximum, and range"	... the configuration of the function element ... the performance of a measurement		✓	✓
7 "Diameter/Radius"	... the configuration of the function element ... the performance of a measurement		✓	✓
8 "Relative measurement"	... the configuration of the function element ... the performance of a measurement		✓	✓
9 "Mastering"	... the configuration of the function element ... the performance of a measurement		✓	✓
10 "Dial gage"	... the configuration of the function element ... the performance of a measurement		✓	✓
12 "Management of parts"	... the configuration of the function element ... the performance of a measurement		✓	✓
13 "Sending measured values to a computer"	... the transmission of measured values to a computer (measured value output)		✓	✓
15 "What to do if ..."	... causes of faults or malfunctions of the product ... corrective actions for faults or malfunctions of the product	✓	✓	✓

Contents

1	Preparing a measurement.....	200
1.1	Cleaning the measured object and the measuring machine.....	200
1.2	Stabilizing the temperature of the measured object.....	200
1.3	Reducing environmental influences.....	200
1.4	Fixing the measured object in place.....	200
1.5	Conducting the reference mark search.....	200
2	Preset.....	202
2.1	Creating a preset table.....	202
2.1.1	Manually creating presets.....	202
2.1.2	Probing the preset.....	203
2.1.3	Deleting presets.....	204
2.2	Selecting a preset.....	204
2.2.1	Activating the preset.....	204
2.2.2	Remote access.....	205
2.2.3	Setting a position as a preset.....	205
2.2.4	Probing the preset.....	206
3	Lengths and angles.....	207
3.1	Measuring lengths and angles.....	207
4	Touch probe.....	208
4.1	Measuring with a touch probe.....	208
5	Probing functions.....	209
5.1	Configuring probing functions.....	209
5.2	Measuring with probing functions.....	210
6	Minimum, maximum, and range.....	212
6.1	Configuring the MinMax function.....	212
6.1.1	Remote access.....	213
6.2	Acquiring the minimum, maximum, and range.....	214
7	Diameter/Radius.....	216
7.1	Configuring the Diameter/Radius function.....	216
7.2	Displaying the diameter.....	217
8	Relative measurement.....	218
8.1	Configuring the Relative function.....	218
8.2	Performing a relative measurement.....	219
9	Mastering.....	220
9.1	Configuring the Mastering function.....	220
9.1.1	Remote access.....	221
9.2	Mastering.....	222



10	Dial gage.....	223
10.1	Configure the Dial gage function.....	223
10.1.1	Adding a function element.....	224
10.1.2	Setting general parameters.....	224
10.1.3	Activating axes.....	224
10.1.4	Entering values.....	225
10.1.5	Activating the trigger signal of an individual axis.....	226
10.1.6	Remote access.....	226
10.2	Measuring with the dial gage.....	228
10.2.1	Overview.....	228
10.2.2	Single view.....	229
10.3	Application example of dial gage: Output trigger signal.....	229
11	Formula.....	232
11.1	Fundamentals of Formula function.....	232
11.2	Adding the Formula function.....	233
11.3	Configuring the Formula function.....	233
11.3.1	Customizing the display of the axes.....	233
11.3.2	Remote access.....	234
11.4	Formula application example: Calculating the mean value.....	235
12	Management of parts.....	238
12.1	Configuring the Part function.....	238
12.1.1	Configuring selected functions.....	239
12.2	Working with part management.....	241
13	Sending measured values to a computer.....	242
13.1	Configuring the measured value output.....	242
13.1.1	Functions for measured value output.....	243
13.1.2	Adding a function element.....	243
13.1.3	Selecting contents for the data transfer.....	244
13.1.4	Remote access.....	244
13.2	Sending measured values to a computer.....	245
14	Starting remote access.....	247
14.1	Starting remote access via REST.....	247
14.2	Starting remote access via MQTT.....	247
14.3	Starting remote access via RS-232.....	247
15	What to do if	248
15.1	Overview.....	249
15.2	Exporting logging files.....	249
15.3	System or power failure.....	249
15.3.1	Restoring the firmware.....	250
15.3.2	Restoring settings.....	250
15.4	Malfunctions.....	250
15.4.1	Troubleshooting.....	250

1 Preparing a measurement

1.1 Cleaning the measured object and the measuring machine

Contamination, for example from chips, dust and oil residues, leads to incorrect measurement results. The measured object, the holder for the measured object, and the sensor must be clean before you start measuring.

- ▶ Clean the measured object, the holder for the measured object, and the sensors with appropriate cleaning products

1.2 Stabilizing the temperature of the measured object

The objects to be measured should be stored at the measuring machine for an appropriate amount of time to allow the objects to adjust to the ambient temperature. Since the dimensions of the measured objects vary with temperature changes, the temperature of the measured objects must be stabilized.

This ensures the reproducibility of the measurement. The reference temperature is usually 20 °C.

- ▶ Stabilize the temperature of the measured objects for an appropriate amount time

1.3 Reducing environmental influences

Environmental influences, such as incident light, ground vibration or air humidity, can affect the measuring machine, the sensors or the measured objects, and thus falsify the measurement results. Certain influences, such as incident light, also have a negative effect on the measurement uncertainty.

- ▶ Eliminate or avoid environmental influences as far as possible

1.4 Fixing the measured object in place

The measured object must be fixed in place on the measuring plate or in an appropriate holder, depending on its size.

- ▶ Position the measured object in the center of the measuring range
- ▶ Use e.g. modeling clay to fix small measured objects in position
- ▶ Use fixtures to fix large measured objects in position
- ▶ Make sure that the measured object is fastened neither too loosely nor too tightly

1.5 Conducting the reference mark search

With the help of reference marks, the unit can assign axis positions of the encoder to the machine.

If no reference marks for the encoder are provided by a defined coordinate system, you need to perform a reference mark search before you start measuring.

i If the reference mark search after unit start is active, then all of the unit's functions will be disabled until the reference mark search has been successfully completed.
Further information: "Reference marks (Encoder)", Page 91

i For encoders with EnDat interface, the reference mark search is omitted because the axes are referenced automatically.

If the reference mark search is active on the unit, then a wizard will ask you to traverse the reference marks of the axes.

- ▶ After logging in, follow the instructions of the wizard
- > The Reference symbol stops blinking upon successful completion of the reference mark search.

Further information: "Operating elements of the position display", Page 34

Further information: "Activating the reference mark search", Page 117

Starting the reference mark search manually

i A manual reference mark search can be performed only by the **Setup** and **OEM** user types.

If the reference mark search was not performed on startup, you can start it manually later.



- ▶ Tap **Settings** in the main menu
- ▶ Open in succession:
 - **Axes**
 - **General settings**
 - **Reference marks**
- ▶ Tap **Start**
- > The Reference icon blinks.
- ▶ Follow the instructions of the wizard
- > The Reference icon stops blinking upon successful completion of the reference mark search.

2 Preset

2.1 Creating a preset table

You can access the preset table on the status bar. The preset table contains the absolute positions of the presets with respect to the reference mark. You can save a maximum of 99 presets in the preset table.

2.1.1 Manually creating presets

If you create presets manually in the preset table, the following applies:

- The entry in the preset table assigns the new position values to the current actual position of the individual axes
- Clearing the entry with **CE** resets the position values for the individual axes to the machine zero point again. The new position values are thus always referenced to the machine zero point



- ▶ Tap **Measure** in the main menu
- ▶ Drag an empty function bar field to the left and into the workspace
- > A dialog box for selecting the function element appears.
- ▶ Tap **Presets**



- ▶ Tap **Close**
- > The function element is now available.



- ▶ Drag the **Presets** function element to the left and into the workspace
- > The **Preset table** dialog box appears.



- ▶ Tap **Add**
- ▶ Enter a name in the **Description** input field
- ▶ Tap the input field for one or more desired axes and enter the appropriate position value
- ▶ Confirm with **RET**
- > The defined preset is added to the preset table.



- ▶ To protect a preset entry from accidental changes or deletion, tap the **Lock** icon next to the preset entry
- > The icon changes and the entry is locked.



- ▶ Tap **Close**
- > The **Preset table** dialog is closed.

2.1.2 Probing the preset

You can use a touch probe to determine presets by probing them. The wizard guides you through each respective step.

Prerequisites:

- The touch probe was configured
- The desired probing function is configured; the **Select preset** function is activated

Further information: "Configuring a touch probe", Page 82

Further information: "Configuring probing functions", Page 209



- ▶ Tap the desired function element on the function bar:

- ▶ **Edge probing**

or



- ▶ **Determining the center line**

or



- ▶ **Determining the circle center**

- ▶ Follow the instructions of the wizard
- > The measured values are acquired when the stylus is deflected.
- > The product determines the desired position based on the measured values.
- > The **Select preset** dialog box appears.
- ▶ To overwrite an existing preset, select the entry from the preset table
- or
- ▶ To add a new preset, enter a new number into the **Selected preset** input field
- ▶ Confirm the entry with **RET**
- ▶ To overwrite a position value, enter the desired value for the corresponding axis under **Set position values**
- ▶ Confirm the entry with **RET**
- or
- ▶ In order to apply a measured position value as the new zero point, leave the input fields under **Set position values** empty
- ▶ Tap **Confirm** in the wizard
- > The system applies the position as the preset.



2.1.3 Deleting presets



- ▶ Drag the **Presets** function element to the left and into the workspace
- > The **Preset table** dialog box appears.



The entries in the preset table can be locked to prevent accidental modification or deletion. So you might need to unlock an entry first in order to edit it.



- ▶ If necessary, tap **Unlock** at the end of the row



- > The entry is enabled for editing.
- ▶ To select presets, tap the checkbox in the relevant row



- ▶ Tap **Delete**
- > A message appears.
- ▶ Close the message with **OK**
- > The selected presets are deleted from the preset table.



- ▶ Tap **Close**
- > The **Preset table** dialog is closed.

2.2 Selecting a preset

The following options are available for defining the preset of a measurement:

- Activate an existing preset from the preset table
- Set a position as a preset by zeroing the axis or entering a position value
- Probing a preset with a touch probe

2.2.1 Activating the preset

Prerequisite:

- The **Presets** function element is available on the function bar
Further information: "Adding a function element to the function bar", Page 38
- The preset table contains presets
Further information: "Creating a preset table", Page 202



- ▶ Tap **Presets**
- ▶ The **Presets** dialog box appears
- ▶ Tap the desired preset



- ▶ Tap **Confirm**
- > The preset is set.
- > The selected preset is displayed in the function element.

2.2.2 Remote access

Remote access via switching functions

You assign digital inputs to specific actions in order to operate remote access via switching functions.

Action	Description
Set a preset	<p>The preset is set.</p> <ul style="list-style-type: none"> ▶ In the Preset table dialog box, swipe across the touchscreen from right to left ▶ Assign the digital input to the desired function <div style="border: 1px solid black; padding: 5px; margin-top: 10px;"> <p> More than one input is available depending on the product variant.</p> </div>

Remote access via remote control commands

You can set presets via Ethernet or RS-232 by sending a command from a connected device to the product.

Further information: "Remote commands", Page 143

2.2.3 Setting a position as a preset

Prerequisite:

- The axes are referenced

Setting the current position as preset



- ▶ Approach the desired position
- ▶ Long-press the **axis key**
- > The active preset in the preset table is overwritten with the current position.
- > The active preset is applied as the new value.

Defining the position values of the current position



- ▶ Approach the desired position
- ▶ In the working space, tap the **axis key** or the position value
- ▶ Enter the desired position value
- ▶ Confirm the entry with **RET**
- > The position value is applied to the current position.
- > The entered position value is linked with the current position and overwrites the active preset in the preset table.
- > The active preset is applied as the new value.

2.2.4 Probing the preset

You can use a touch probe to determine presets by probing them. The wizard guides you through each respective step.

Prerequisites:

- The touch probe was configured
- The desired probing function is configured; the **Select preset** function is activated

Further information: "Configuring a touch probe", Page 82

Further information: "Configuring probing functions", Page 209



- ▶ Tap the desired function element on the function bar:

- ▶ **Edge probing**

or



- ▶ **Determining the center line**

or



- ▶ **Determining the circle center**

- ▶ Follow the instructions of the wizard
- > The measured values are acquired when the stylus is deflected.
- > The product determines the desired position based on the measured values.
- > The **Select preset** dialog box appears.
- ▶ To overwrite an existing preset, select the entry from the preset table
- or
- ▶ To add a new preset, enter a new number into the **Selected preset** input field
- ▶ Confirm the entry with **RET**
- ▶ To overwrite a position value, enter the desired value for the corresponding axis under **Set position values**
- ▶ Confirm the entry with **RET**
- or
- ▶ In order to apply a measured position value as the new zero point, leave the input fields under **Set position values** empty
- ▶ Tap **Confirm** in the wizard
- > The system applies the position as the preset.



3 Lengths and angles

3.1 Measuring lengths and angles

Requirement:

- The axes have been configured
Further information: "Configuring the axes", Page 83
- The reference mark search has been successfully completed
Further information: "Performing the reference mark search after startup", Page 27

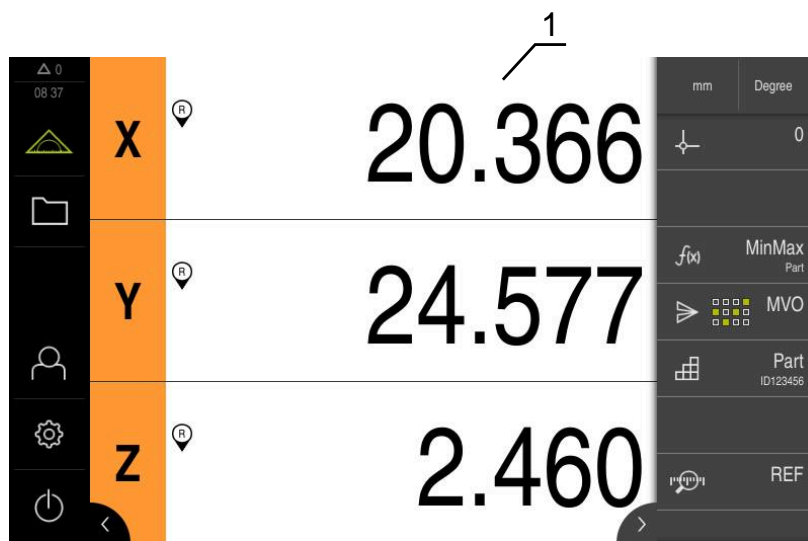

Figure 36: **Measure** menu

1 Current axis positions

- ▶ Select a preset where necessary
- ▶ Move to the desired position or acquire measured values
- > The result can be read.
- > You can send the measured values to a computer.

Further information: "Sending measured values to a computer", Page 245

4 Touch probe

4.1 Measuring with a touch probe

Requirement: The touch probe has been configured

Further information: "Configuring a touch probe", Page 82

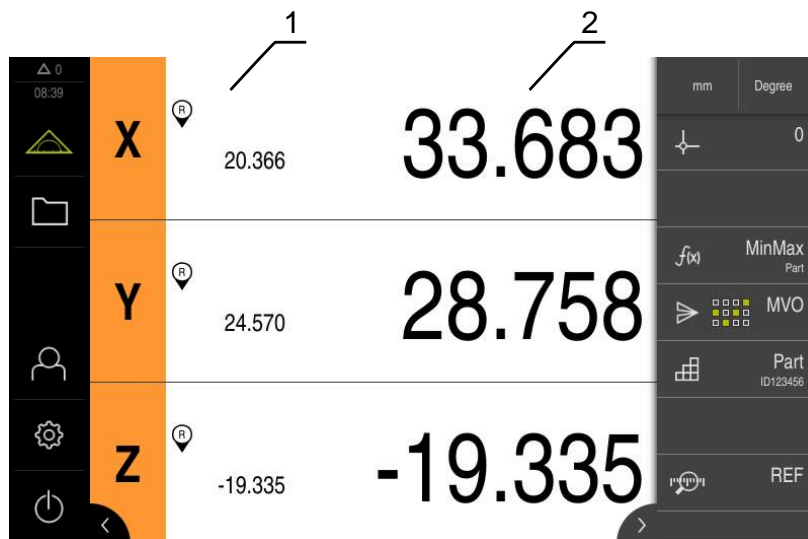

Figure 37: **Measure** menu with touch probe

- 1 Current axis position
- 2 Last measured value, captured upon deflection of the stylus
 - ▶ Select a preset where necessary
 - ▶ Move to the desired position
 - ▶ The display of the position is updated when the stylus is deflected.
 - ▶ You can send the measured values to a computer.

Further information: "Sending measured values to a computer", Page 245

5 Probing functions

5.1 Configuring probing functions

The probing functions assist you in the acquisition of positions. The wizard guides you through each respective step.

When configuring the probing functions, you can specify whether the **Select preset** dialog box will be displayed afterwards and whether the measured values will be transferred automatically to a computer.

Prerequisites:

- The touch probe was configured
- The optional interface for data transmission was configured

Further information: "Configuring a touch probe", Page 82

Further information: "Configuring the measured value output", Page 242

The following probing functions are available:

Icon	Function	Scheme
	<p>Edge probing</p> <p>Probe the edge of a workpiece (one probing procedure)</p> <p>Determines the coordinate of the traversed axis</p>	
	<p>Determining the center line</p> <p>Determine the centerline of a workpiece (two probing procedures)</p> <p>Determines the coordinate of the traversed axis</p>	
	<p>Determining the circle center</p> <p>Determine the center point of a circular form (hole or cylinder) (four probing procedures)</p> <p>Determines the coordinates of both axes and the circle diameter</p>	

Adding a function element



- ▶ Tap **Measure** in the main menu
- ▶ Drag an empty function bar field to the left and into the workspace
- A dialog box for selecting the function element appears.



- ▶ Tap the desired function element (e.g., **Determining the circle center (probing)**)
- The function element is now available.

Configuring a function



- ▶ Drag the function element to the left in the workspace
- ▶ Use the **ON/OFF** sliding switch in the dialog to activate the desired functions:
 - **MVO**: The measured value is automatically transferred to the computer
 - **Select preset**: Once probing has completed, you can use the acquired coordinates as preset
- ▶ When using the **Determining the circle center** probing function, select the plane of the circle via the drop-down lists; default: Plane of the **X** and **Y** axes



- ▶ Tap **Close**
- The selection is saved.



The product uses the data format for measured value output that is selected for manual data transmission in the product settings.

Further information: "Selecting a data format", Page 134

5.2 Measuring with probing functions

A touch probe allows you to determine positions by probing. For this purpose, the product provides special probing functions. A wizard guides you through the procedure.

Requirements:

- The touch probe has been configured
- The desired probing function has been configured
- When determining a new preset: The **Select preset** function must be activated in the settings of the function element
- When using the **Determining the circle center** probing function: At least two axes are configured with a linear encoder or an angle encoder as linear encoder

Further information: "Configuring a touch probe", Page 82

Further information: "Configuring probing functions", Page 209

Further information: "Configuring the axes", Page 83



Figure 38: Function bar with the function elements for probing functions

- 1 Function elements start the wizard for probing a measured object
- 2 If measured value output is activated, the function element shows the interface for data transmission





- ▶ Tap the desired function element on the function bar:
- ▶ **Edge probing**
or
- ▶ **Determining the center line**
or
- ▶ **Determining the circle center**
- ▶ Follow the instructions of the wizard
- ▶ The measured values are acquired when the stylus is deflected.
- ▶ The product determines the desired position based on the measured values.
- ▶ If the **Select preset** function is activated, a dialog appears in which you can apply the position as the new preset.
- ▶ If the **MVO** function is enabled, the product transmits the measured values to the computer.

6 Minimum, maximum, and range

6.1 Configuring the MinMax function

The **MinMax** function helps you to acquire the following measured values:

Minimum	Maximum	Range
		

You can activate and deactivate this function by tapping the **MinMax** function element on the function bar. When the function is active, the measured values will be captured and shown in the position display. You can then transfer the measured values to a computer via the measured value output. If you activate the **MinMax** function again, then the existing measured values will be overwritten.

The following steps are necessary in order to configure the **MinMax** function:

- Add the **MinMax** function element to the function bar
- Select measured values that are to be captured and displayed when the **MinMax** function is active

Adding a function element



- ▶ Tap **Measure** in the main menu
- ▶ Drag an empty function bar field to the left and into the workspace
- > A dialog box for selecting the function element appears.
- ▶ Tap the **MinMax** function element
- > The **MinMax** function element is now available.

Selecting measured values



- ▶ Drag the **MinMax** function element to the left and into the workspace
- > A dialog box for selecting the measured values appears.
- ▶ Enter a name in the **Name** input field
- ▶ Enter more information in the **Comment** input field if required
- ▶ Tap the desired measured values to select them



- ▶ Tap **Close**
- > The selection is saved.
- > If you activate the **MinMax** function, the selected measured values will be captured and shown in the position display



Ensure that the **MinMax** function covers all measured values that you want to send to a computer as part of the measured value output. If measured values are missing then the value 0 is sent.



The measured value output always transmits the last position values acquired. If you do not move an axis, the previously acquired values will be transferred.

6.1.1 Remote access

You have various options for remote access. You can control the product via switching functions or you can send commands from a connected device via Ethernet oder RS-232.

Requirement: A connection has already been set up (e.g., GC/mvo)

Further information: "Activating the interface for Data transfer", Page 147

Activating a switching function

You assign digital inputs to specific actions in order to operate remote access via switching functions.

Action	D
Start function	The function is started.
Stop function	The function is terminated.
Pause function	The function is paused and can be restarted using Start function .
Restart function	The function is terminated and restarted.

- ▶ In the **MinMax** dialog box, swipe across the touchscreen from right to left
- ▶ Assign the digital input to the desired function



More than one input is available depending on the product variant.

Activating Remote commands

You activate commands in order to operate remote access via remote control commands. You can use default commands or your own commands.

Action	Description	Default command
Start function	The function is started.	fctStartCmd1 ¹⁾
Stop function	The function is terminated.	fctStopCmd1 ¹⁾
Pause function	The function is paused and can be restarted using Start function .	fctPauseCmd1 ¹⁾
Restart function	The function is terminated and restarted.	fctRestartCmd1 ¹⁾

¹⁾ The numbering is incremented sequentially.

- ▶ In the **MinMax** dialog box, swipe twice across the touchscreen from right to left
- ▶ Tap **Reset all user commands to default values** or
- ▶ Tap the input field and enter your own command



6.2 Acquiring the minimum, maximum, and range

Requirement: The **MinMax** function has been configured

Further information: "Configuring the MinMax function", Page 212

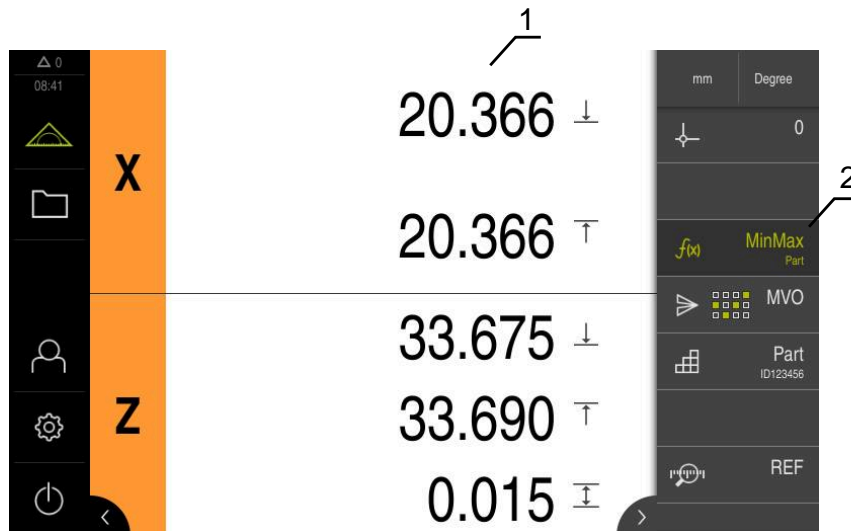



Figure 39: **Measure** menu with active **MinMax** function

- 1 Minimum, maximum, and range
- 2 Function element when the **MinMax** function is active

You can activate the **MinMax** function during the measurement in order to determine the following values:

- **Minimum:** lowest value
- **Maximum:** highest value
- **Range:** difference between the highest and the lowest value

 The individual configuration determines which value are captured and shown in the position display



- ▶ Select a preset where necessary
- ▶ Tap **MinMax** in order to start the acquisition
- ▶ The green lettering of the function element indicates that the **MinMax** function is active.
- ▶ The position display shows the minimum, maximum, and range for each axis (depending on the configuration).
- ▶ Perform measurement
- ▶ In order to interrupt the acquisition, drag the green **MinMax** function element to the right
- ▶ The **MinMax** function is paused, and the icon turns gray.
- ▶ Tap the gray **MinMax** function element in order to continue capturing
- ▶ To complete the capture processes, tap the green **MinMax** function element
- ▶ The **MinMax** function is deactivated.
- ▶ The position display shows the current position of each axis.
- ▶ You can send the measured values to a computer.

Further information: "Sending measured values to a computer", Page 245



The last measured values remain in the product's buffer memory and can be transferred via measured value output, until you capture new measured values with the **MinMax** function.

7 Diameter/Radius

7.1 Configuring the Diameter/Radius function

The **Diameter/Radius** function allows you to double position values in the position display. With radial axes, you can thus switch between the radius and diameter. You can activate and deactivate the conversion by tapping the **D/R** function element on the function bar. When you configure the function element, you can define which axes will be affected by the conversion.

The following steps are necessary in order to configure the **Diameter/Radius** function:

- Add the **D/R** function element to the function bar
- Select the axes to be affected by the switch

Adding a function element



- ▶ Tap **Measure** in the main menu
- ▶ Drag an empty function bar field to the left and into the workspace
- > A dialog box for selecting the function element appears.



- ▶ Tap the **D/R** function element
- > The **D/R** function element is now available.

Selecting axes



- ▶ Drag the **D/R** function element to the left and into the workspace
- > A dialog box for selecting the axes appears.



- ▶ In order to select axes, tap each diameter symbol



- ▶ Tap **Close**
- > The selection is saved.
- > When you activate the **D/R** function, the product doubles the position value of the selected axes.

7.2 Displaying the diameter

Requirement: The **Diameter/Radius** function has been configured

Further information: "Configuring the Diameter/Radius function", Page 216

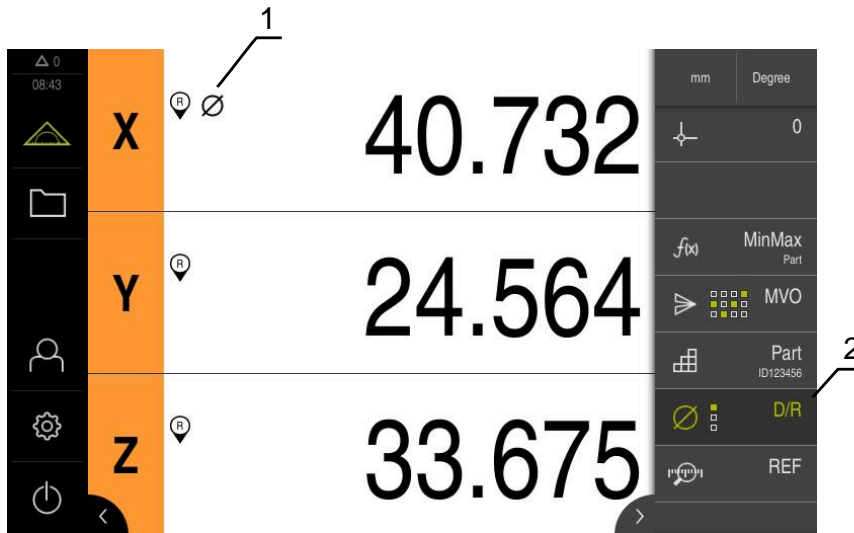





Figure 40: **Measure** menu with active **D/R** function

- 1 The diameter symbol indicates that the conversion of the position value for the axis is active
- 2 Function element with active **D/R** function

By means of the **Diameter/Radius** function, you can double position values in the position display. With radial axes, you can thus switch between the radius and diameter. You can activate and deactivate the conversion by tapping the **D/R** function element on the function bar. When you configure the function element, you can define which axes will be affected by the conversion.

- 
 - ▶ In order to display the diameter, tap the **D/R** function element
 - > The green lettering of the function element indicates that the **D/R** function is active.
 - > The product doubles the position values of the selected axes.
- 
 - > For the axes whose position value is converted, the diameter symbol appears.
- 
 - ▶ In order to display the radius, tap the **D/R** function element again
 - > This conversion is deactivated for all axes.

8 Relative measurement

8.1 Configuring the Relative function

The **Relative** function allows you to measure independently of the selected preset. When the **Relative** function is active, you can zero axes and perform measurements, for example, without these actions affecting the selected preset. When you deactivate the **Relative** function, all of the position values and measuring steps are once again referenced to the selected preset.

You can activate and deactivate this function by tapping the **Relative** function element on the function bar.

Adding a function element



- ▶ Tap **Measure** in the main menu
- ▶ Drag an empty function bar field to the left and into the workspace
- > A dialog box for selecting the function element appears.



- ▶ Tap the **Relative** function element
- > The **Relative** function element is now available.

8.2 Performing a relative measurement

Requirement: The **Relative** function has been configured

Further information: "Configuring the Relative function", Page 218

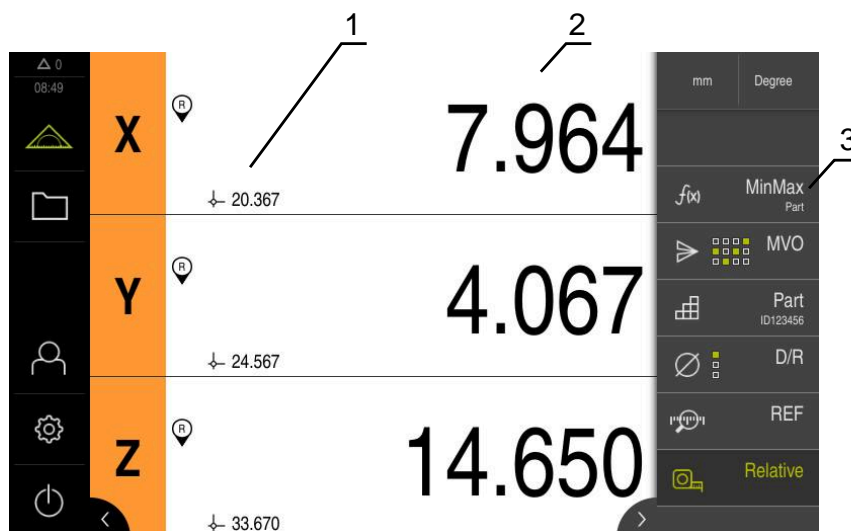

Figure 41: **Measure** menu with activated **Relative** function

- 1 Position value referenced to the selected preset
- 2 Position value of the relative measurement, independent of the selected preset
- 3 Function element with active **Relative** function

The **Relative** function allows you to perform relative measurements independently of the selected preset. When the **Relative** function is active, the preset table is barred from editing, so that the zeroing of axes or the overwriting of position values has no effect on the selected preset.



- ▶ In order to perform a relative measurement, tap the **Relative** function element
- > The green lettering of the function element indicates that the **Relative** function is active.
- > The position display switches over to the position values of the relative measurement.
- > The preset table is barred from editing.
- ▶ Zero the axis as needed
- or
- ▶ Overwrite the position values as needed
- ▶ Perform the desired measurement



- ▶ In order to end the relative measurement, tap the **Relative** function element again
- > The position display switches over to the standard view.
- > The preset table is enabled for editing.

9 Mastering

9.1 Configuring the Mastering function

The **Mastering** function allows you to set the position values in the position display. Measure, for example, a part on the measuring machine and save the values from the measuring log as a reference part. In addition, you can directly adopt the values of a part that you are using as a reference part from the position display. When configuring the function element, you specify the axes to be affected by **Mastering**.

The following steps are necessary in order to configure the **Mastering** function:

- Add the **Mastering** function element to the function bar
- Select the axes
- Enter or load the values that will be set

Adding a function element



- ▶ Tap **Measure** in the main menu
- ▶ Drag an empty function bar field to the left into the workspace
- > The dialog for selecting the function element appears.



- ▶ Tap the **Mastering** function element
- > The function element is now available.

Configuring the values



- ▶ Drag the **Mastering** function element to the left into the workspace
- > The **Mastering** dialog box appears.
- ▶ Enter a name in the **Name** input field
- ▶ Enter more information in the **Comment** input field if required
- ▶ Tick the checkbox of the desired axes



- ▶ Tap **Apply** in order to load the current values of the position display
- or

- ▶ Enter values for the desired axes



- ▶ Tap **Close**

9.1.1 Remote access

You have various options for remote access. You can control the product via switching functions or you can send commands from a connected device via Ethernet oder RS-232.

Requirement: A connection has already been set up (e.g., GC/mvo)

Further information: "Activating the interface for Data transfer", Page 147

Activating a switching function

You assign digital inputs to specific actions in order to operate remote access via switching functions.

Action	Description
Trigger function	<p>The function is started.</p> <ul style="list-style-type: none"> ▶ In the Mastering dialog box, swipe across the touchscreen from right to left ▶ Assign the digital input to the desired function <div style="border: 1px solid black; padding: 5px; margin-top: 10px;">  More than one input is available depending on the product variant. </div>

Activating Remote commands

You activate commands in order to operate remote access via remote control commands. You can use default commands or your own commands.

Action	Description	Default command
Trigger function	The function is started.	fctStartCmd1 ¹⁾

1) The numbering is incremented sequentially.

- ▶ In the **Mastering** dialog box, swipe twice across the touchscreen from right to left
- ▶ Tap **Reset all user commands to default values** or
- ▶ Tap the input field and enter your own command



9.2 Mastering

Requirement: The **Mastering** function is configured

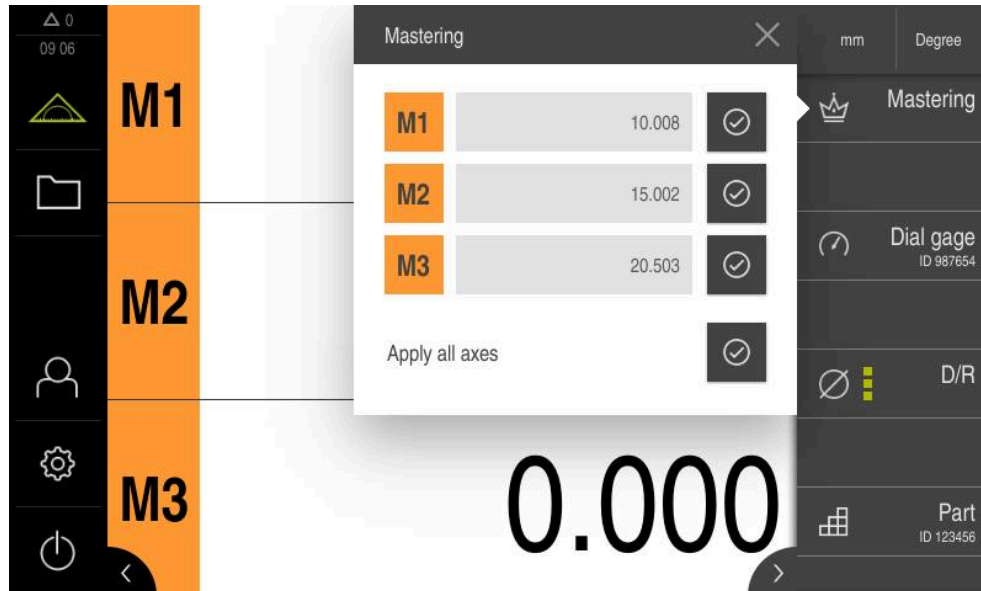

Figure 42: **Measure** menu with open **Mastering** function

The **Mastering** function allows you to set saved position values in the position display.



- ▶ Tap **Mastering**



- ▶ Set each axis value individually
or
- ▶ Tap **Apply all axes** to set all of the saved values
- ▶ The current position values are overwritten with the saved values

10 Dial gage

10.1 Configure the Dial gage function

The dial gage provides a graphical depiction of the nominal values, the warning threshold values, and the tolerance limits. The **dial gage** function has various views. With the dial gage, you can perform absolute measurements or difference measurements.

You can save the settings of the dial gage, use them on other devices, or call them again at a later time.

Absolute measurement

In an absolute measurement, the nominal value is entered with its limits. You can specify ahead of time whether you want to enter the limits as absolute or relative values. In the subsequent measurement, the actual value is determined and compared with the nominal value.

Difference measurement

In a difference measurement, the distance between the actual value and zero or a specified value is determined. For difference measurements, you can, for example, manufacture a reference part and then, for each measurement, **Zero the current axis values** of your axis or use **Mastering** to reset your axis.

Further information: "Configuring the Mastering function", Page 220

Comparison of graphical depictions

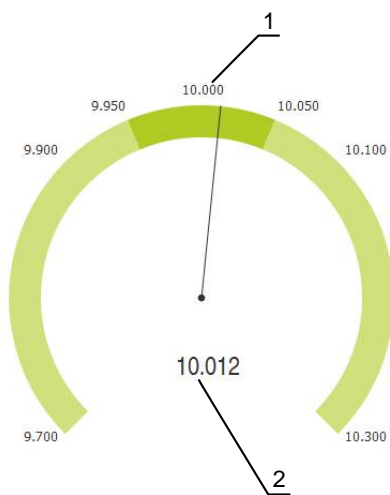

Figure 43: Example of an absolute measurement

- 1 Nominal value (e.g., 10.000)
- 2 Actual value (e.g., 10.012)

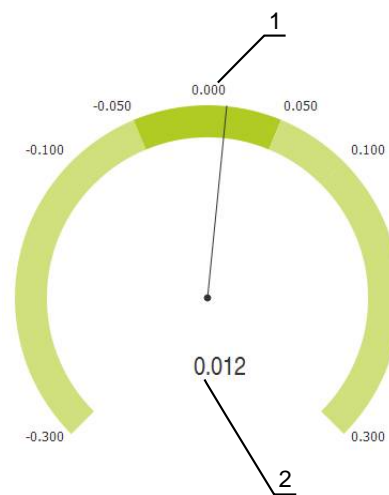

Figure 44: Example of a difference measurement

- 1 Nominal value (e.g., 0.000)
- 2 Difference from nominal value: (e.g., 0.012)

10.1.1 Adding a function element

The following steps are necessary in order to configure the **dial gage** function:

- Add the **dial gage** function element to the function bar
- Set the general parameters
 - Assign names
 - Value input
- Configure parameters of the individual axes
 - Activate the dial gage for the desired axes
 - Enter limit values
 - Activate and configure switching functions if required



- ▶ Tap **Measure** in the main menu
- ▶ Drag an empty function bar field to the left and into the workspace
- > The dialog for selecting the function element appears.



- ▶ Tap the **dial gage** function element
- > The **dial gage** function element is now available.

10.1.2 Setting general parameters



- ▶ Drag the **dial gage** function element to the left in the workspace
- > The **dial gage** dialog box appears.
- ▶ Enter a name in the **Name** input field
- ▶ Select the desired entry in **Value input**:
 - **absolute**
 - **relative**

10.1.3 Activating axes

You can activate and display each axis separately. As soon as you have activated an axis, you can enter the corresponding values for this axis.



- ▶ Tap the desired axis in the **dial gage** dialog
- ▶ Activate the dial gage with the slide switch for the axis
- > The input fields are populated with standard values.



If you deactivate an activated axis with the slide switch, then the entered values are deleted. As soon as you reactivate the deactivated axis, the input fields are repopulated with default values.

10.1.4 Entering values

After you activated the dial gage for your axis, you can enter values.

The device offers two possibilities to enter values:

- Enter values individually
- Enter values symmetrically

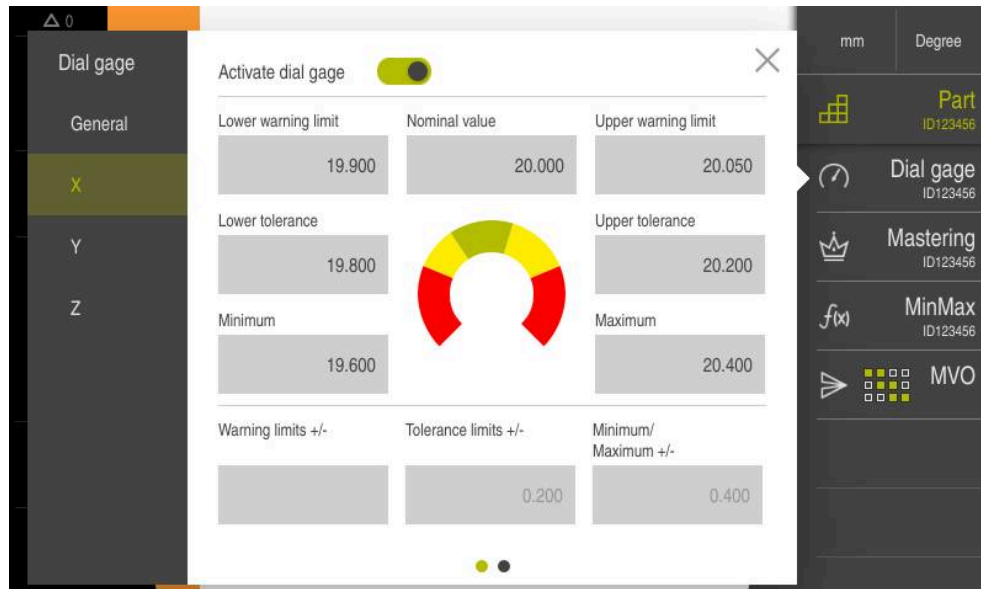

Figure 45: Example of a value input for an axis

Entering values individually

- ▶ Tap the input field
- ▶ Enter the desired value
- ▶ Confirm the entry with **RET**
- > The entered value is applied.

Entering values symmetrically

If you want your desired entry to exhibit identical positive and negative limit values, then you can change the magnitude of these limit values at the same time by using the **Warning limits**, **Tolerance limits** and **Minimum/ Maximum** input fields.

If you have selected **absolute** value input, then the respective values will be calculated based on the nominal value.

If you have selected **relative** value input, the entered value (positive and negative) will be transferred directly.

±

- ▶ Tap inside the desired input field
- ▶ Enter the desired value
- ▶ Confirm the entry with **RET**
- > The entered value is applied.

10.1.5 Activating the trigger signal of an individual axis

You can assign a switching function to the axes, which generates a trigger signal at a digital output when a limit you determined is exceeded. This allows you to process an exceeded limit value as a trigger signal.

A trigger signal can be generated when the following limit values are exceeded:

- **Nominal value**
- **Warning limits**
- **Tolerance limits**
 - ▶ Tap the desired axis in the **dial gage** dialog
 - ▶ The dialog for entering the values is opened.
 - ▶ Swipe right to left over the touchscreen
 - ▶ Select the desired limit value
 - **Nominal value**
 - **Warning limits**
 - **Tolerance limits**
 - ▶ Select the desired digital output

 You can select more than one limit value for devices with ID 1089182-01.

- ▶ Select the desired type of switching
 - **High level on exceeding**
 - **Low level on exceeding**
- ▶ Activate **Pulse** with the slide switch if required
- ▶ Enter **Pulse time** if required

10.1.6 Remote access

You have various options for remote access. You can control the product via switching functions or you can send commands from a connected device via Ethernet oder RS-232.

Requirement: A connection has already been set up (e.g., GC/mvo)

Further information: "Activating the interface for Data transfer", Page 147

Activating the switching function

You assign digital inputs to specific actions in order to operate remote access via switching functions.

Action	Description
Start function	The function is started.
Stop function	The function is terminated.

- ▶ In the **Dial gage** dialog box (General tab), swipe across the touchscreen from right to left
- ▶ Assign the digital input to the desired function

 More than one input is available depending on the product variant.

Activating Remote commands

You activate commands in order to operate remote access via remote control commands. You can use default commands or your own commands.

Action	Description	Default command
Start function	The function is started.	fctStartCmd1 ¹⁾
Stop function	The function is terminated.	fctStopCmd1 ¹⁾

¹⁾ The numbering is incremented sequentially.



- ▶ In the **Dial gage** dialog box (General tab), swipe twice across the touchscreen from right to left
- ▶ Tap **Reset all user commands to default values**
or
- ▶ Tap the input field and enter your own command

10.2 Measuring with the dial gage

10.2.1 Overview

The overview shows the current measurement values of all configured axes of the device in the dial gage depiction.



Figure 46: Overview

- 1 Dial gage depiction of the X axis value
- 2 Dial gage depiction of the Y axis value
- 3 **Dial gage** function element
- 4 Zero the current axis values
- 5 Dial gage depiction of the Z axis value

Depending on the deviation between the nominal value of the measurement and the specified tolerance values and warning values, the dial gage depiction of the measured value appears in a different colors:

Color	Evaluation
Green	The measured value lies within the warning limits.
Orange	The measured value exceeds the warning limit but still lies within the tolerance limit.
Red	The measured value exceeds the tolerance limit.

Opening the overview

To open the overview:



- ▶ Tap the **dial gage** function element on the function bar
- > The overview opens

10.2.2 Single view

The single view shows the current measurement results of the selected axis in the dial gage depiction.

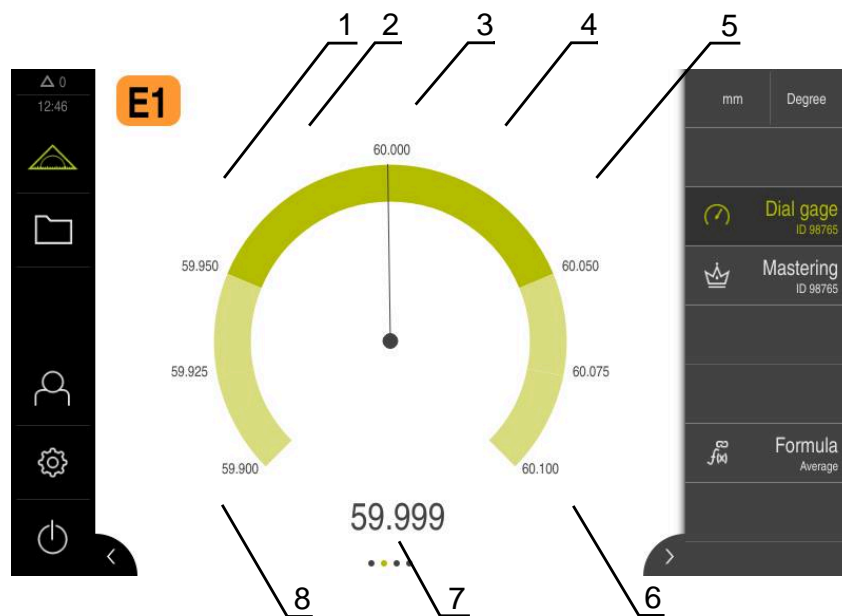

Figure 47: Single view of the **dial gage**

- 1 Minimum tolerance limit
- 2 Minimum warning limit
- 3 Nominal value
- 4 Maximum warning limit
- 5 Maximum tolerance limit
- 6 Maximum limit
- 7 Actual value
- 8 Minimum limit

Opening the single view

To switch from the overview to the single view of an axis:

- ▶ Tap the desired single view,
or
- ▶ Swipe across the touchscreen from right to left until the desired single view appears
- > The single view opens

10.3 Application example of dial gage: Output trigger signal

In this application example you define how trigger signals can be configured. The example shows how a green lamp (connected to Dout 0) lights up for good parts. The green lamp lights up over the complete good range (14.95...15.05). If one of the two tolerance values is exceeded, the lamp switches off.

Adding the dial gage function

The following steps are necessary in order to configure the **dial gage** function:

- Add the **dial gage** function element to the function bar
- Set the general parameters
 - Assign names
 - Value input
- Configure parameters of the individual axes
 - Activate the dial gage for the desired axes
 - Enter limit values
 - Activate and configure switching functions if required



- ▶ Tap **Measure** in the main menu
- ▶ Drag an empty function bar field to the left and into the workspace
- > The dialog for selecting the function element appears.



- ▶ Tap the **dial gage** function element
- > The **dial gage** function element is now available.

- ▶ Drag the **dial gage** function to the left into the working space
- > The **dial gage** dialog box appears.
- ▶ Enter a name in the **Name** input field
- ▶ Select the desired entry **absolute** in **Value input**

Entering example values

Activating axes



- ▶ Tap axis **E1**
- ▶ Activate the dial gage with the slide switch for the axes

Entering values

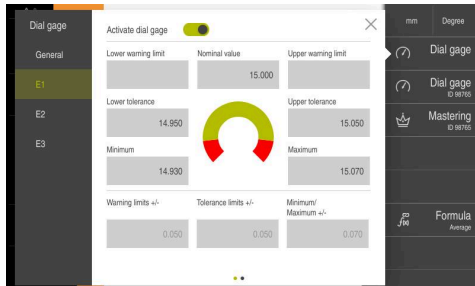

- ▶ Tap **Nominal value** in the input field
- ▶ Enter the value **15**
- ▶ The value **15** is displayed as **Nominal value** and considered for the following calculations.
- ▶ Tap **Tolerance limits +/-** in the input field
- ▶ Enter the value **0.05**
- ▶ Based on the **Nominal value**, the value is offset symmetrically and entered in **Lower tolerance** and **Upper tolerance**.
- ▶ Tap **Minimum/ Maximum +/-** in the input field
- ▶ Enter the value **0.07**
- ▶ Based on the **Nominal value**, the value is offset symmetrically and entered in **Minimum** and **Maximum**.

 This example does not use warning limits.

Activating the trigger signal

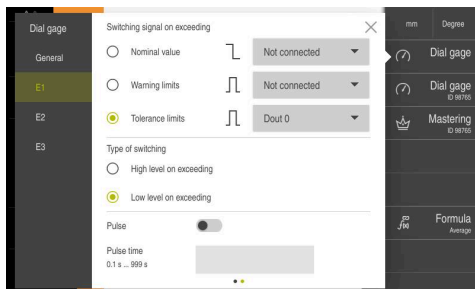

- ▶ Swipe across the touchscreen from right to left
- ▶ Select **Tolerance limits** as trigger signal for limit violations
- ▶ Select **Dout 0** in the drop-down list
- ▶ Select **Low level on exceeding** as trigger type
- ▶ Tap **Close**
- ▶ Tap **dial gage**
- ▶ The **dial gage** function is activated.

Display if measured value is within the tolerance



- > The dial gage is displayed in green.
- > The green lamp connected to Dout 0 lights up and indicates a good part.

Display if measured value is outside the tolerance



- > The dial gage is shown in red.
- > The green lamp connected to Dout 0 is off.

11 Formula

11.1 Fundamentals of Formula function

With the **Formula** function, you can offset position values. For instance, you can calculate the mean value of the axes. Many different arithmetic operations are available for this. You can combine the **Formula** function with other functions.

The following functions can be combined:

- **Dial gage**
- **MinMax**
- **Measured value output**

You have various options for displaying the axes.

- Show only the result of the calculated axis
- Show real axes and the calculated axis

To configure the Formula function, the following steps are necessary:

- Add the Formula function element to the function bar
- Enter the name and formula for the calculated new axis



You can generate up to three formulas.

When the **Formula** function is activated, you cannot activate or configure the **Presets** function.

11.2 Adding the Formula function

Adding a function element



- ▶ Tap **Measure** in the main menu
- ▶ Drag an empty function bar field to the left into the workspace
- > The dialog for selecting the function element appears.



- ▶ Tap the **Formula** function element
- > The **Formula** function element is now available.

11.3 Configuring the Formula function

Enter the name and formula for the calculated new axis



- ▶ Drag the Formula function element to the left into the workspace
- > The Formula dialog box appears.
- ▶ Enter a name in the **Name** input field
- ▶ Enter more information in the **Comment** input field if required



- ▶ Tap **Add**
- > An input field for the new, calculated axis is added.
- ▶ Enter a name for the calculated axis in the **formula label**



Up to two characters (letters or numerals) are possible.

- ▶ Tap in the input field
- ▶ Enter the desired arithmetic operations
 - You have to select the real axes for the formula via the orange axis fields
 - Select the desired arithmetic operations on the keyboard being displayed.
 - Calculated axes can be used, too.



The feasibility of the calculation is already checked while you are entering your selection.

- ▶ Press **Return** to conclude your entry
- > The **Formula** is displayed in the input field.



- ▶ Tap **Close**
- > The **Formula** was configured successfully.

11.3.1 Customizing the display of the axes

You can change the display of the axes. You can show or hide real axes. You can change the sequence of the axes individually.



- ▶ Drag the Formula function element to the left into the workspace
- > The Formula dialog box appears.

Showing and hiding axes



- ▶ Tap the eye to hide real axes



- > If the **Formula** function is activated, the hidden real axis is not displayed.

Changing the sequence of displayed axes



- ▶ Hold the gripper
- > The drag-and-drop mode is activated. The line is shown in orange.
- ▶ Hold and move the gripper as desired
- > The axis sequence is changed.
- ▶ To end the drag-and-drop mode, tap the gripper
- > The axis sequence is changed.

11.3.2 Remote access

You have various options for remote access. You can control the product via switching functions or you can send commands from a connected device via Ethernet oder RS-232.

Requirement: A connection has already been set up (e.g., GC/mvo)

Further information: "Activating the interface for Data transfer", Page 147

Activating a switching function

You can assign digital inputs to various actions in order to operate the function via switching functions.

Action	Description
Start function	The function is started.
Stop function	The function is terminated.

- ▶ In the **Formula** dialog box (General tab), swipe across the touchscreen from right to left
- ▶ Assign the digital input to the desired function



More than one input is available depending on the product variant.

Activating Remote commands

You can activate commands in order to operate the function via remote control commands. You can use default commands or your own commands.

Action	D	Default command
Start function	The function is started.	fctStartCmd1 ¹⁾
Stop function	The function is terminated.	fctStopCmd1 ¹⁾

¹⁾ The numbering is incremented sequentially.

- ▶ In the **Formula** dialog box (General tab), swipe twice across the touchscreen from right to left
- ▶ Tap **Reset all user commands to default values**
or
- ▶ Tap the input field and enter your own command



11.4 Formula application example: Calculating the mean value

In this application example, a specific formula is defined. The mean value of the three axes E1, E2 and E3 is calculated. This will then be displayed as a calculated axis with the designation AV. The real axes are hidden if the formula is activated.

Adding the Formula function



- ▶ Tap **Measure** in the main menu
- ▶ Drag an empty function bar field to the left into the workspace
- ▶ The dialog for selecting the function element appears.



- ▶ Tap the **Formula** function element
- ▶ The **Formula** function element is now available.
- ▶ Drag the **Formula** function to the left into the working space

Specifying the Formula function

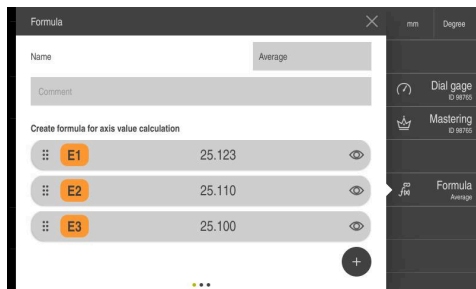

- ▶ Enter the name **Average** in the **Name** input field
- ▶ Enter a comment if required
- ▶ Tap **Add**

Specify the formula label

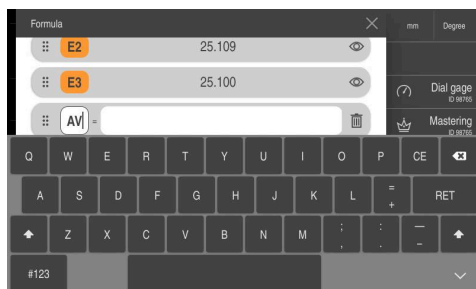

- ▶ Enter **AV** in the formula label

Entering the formula



- ▶ In the input field, enter the formula $(E1 + E2 + E3) \div 3$ for the calculation of the mean value
- ▶ The formula has been entered correctly mathematically; a green checkmark is shown.
- ▶ Press **RET** to conclude the entry of the formula

Hiding axes

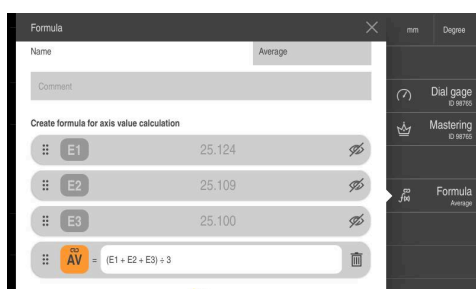

- ▶ Tap on the eye next to the axis values
- ▶ The axes are hidden if the formula is activated.

Activating the Formula function

- ▶ Tap the **Formula** function element
- > The mean value is shown as new calculated axis.
- > The other axes are hidden.

12 Management of parts

12.1 Configuring the Part function

The **Part** function encompasses the required functions for the object to be measured. When the **Part** function is activated, then all of the irrelevant functions are hidden. You can save the required functions separately for every object of measurement, and then export or import the saved functions. If you deactivate the **Part** function, then all of the active functions within the part will also be deactivated. You can add the following functions to the **Part** function as many times as needed:

- **Dial gage**
- **Mastering**
- **MinMax**
- **MVO**

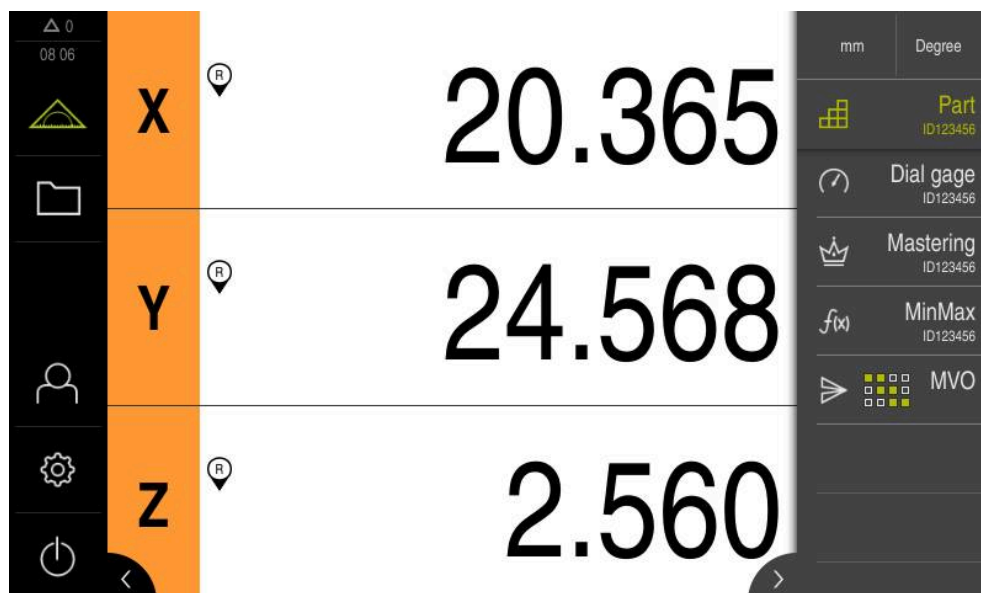

Figure 48: Example of active **Part** function with selected functions

Adding a function element



- ▶ Tap **Measure** in the main menu
- ▶ Drag an empty function bar field to the left and into the workspace
- ▶ A dialog box for selecting the function element appears.



- ▶ Tap the **Part** function element
- ▶ The **Part** function element is now available.

12.1.1 Configuring selected functions

Saving functions



- ▶ Drag the **Part** function element to the left and into the workspace
- > The **Part** dialog box appears
- ▶ Enter a name in the **Name** input field
- ▶ Enter more information in the **Comment** input field if required
- ▶ Select the functions that you want to add
- ▶ Use the **+** or **-** buttons to enter how many times you want to add a specific function to the Part function
- ▶ Tap **Close**



When the **Part** function is activated, you can still add new functions to the function bar using the described procedure.

Further information: "Adding a function element to the function bar", Page 38

Activating the Part function



- ▶ Tap **Part**
- > The green lettering of the function element indicates that the function is active
- > All other functions of the function bar are hidden. Only the functions that you have previously selected are displayed

Configuring saved functions

You can configure the functions that you have saved. The configuration procedure is the same as the one you are familiar with from outside of a part.

In addition, you can import or export the saved configuration data using a file in XMG format.

Further information: "Configure the Dial gage function", Page 223



Further information: "Configuring the Mastering function", Page 220

Further information: "Configuring the MinMax function", Page 212

Further information: "Configuring the measured value output", Page 242

Importing or exporting configuration data

If you want to reuse the configured functions that you have saved in a part, you can export them and import them into another function. The import and export behave differently from what you are familiar with from outside of a part. If you change an imported configuration within a part, the configuration file will not be changed.

Function	Description
	<p>Export</p> <p>The configuration is exported. If you open and change the file within a different function, then the configuration that is saved in the part will remain unchanged.</p>
	<p>Import</p> <p>The configuration is imported. If you import the configuration file into a part, the data will be imported. You can change the data, but the configuration file will remain unchanged.</p> <p>If you want to change configuration file, you can use the export function to overwrite the file.</p>

Exporting configuration data from a part



- ▶ Drag the desired function element to the right
- ▶ Tap **Save**
- > The **Save configuration** dialog box appears
- ▶ Select the folder to which you want to save the configuration
- ▶ Specify a name for the XMG file
- ▶ Confirm with **RET**
- ▶ Tap **Save**
- > The file has been saved

Importing configuration data into a part



- ▶ Drag the desired function element to the right
- ▶ Tap **Open**
- > The **Open configuration** dialog box appears
- ▶ Navigate to the folder in which the saved file is stored
- ▶ Tap the desired XMG file
- ▶ Tap **Open**
- > The data will be imported

12.2 Working with part management

Prerequisite: The **Part** function has been configured

Further information: "Configuring the Part function", Page 238

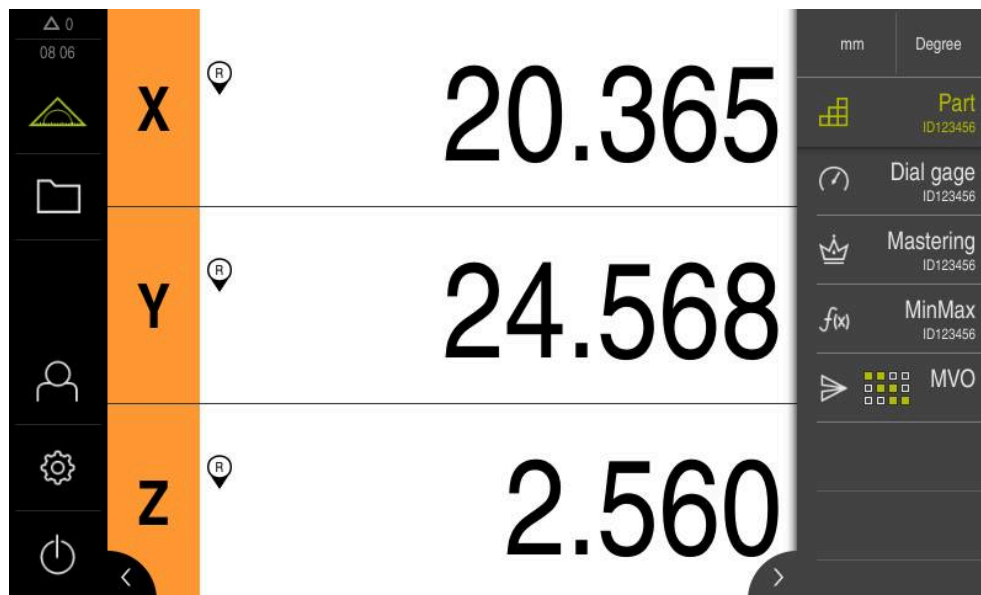

Figure 49: **Measure** menu with activated **Part** function

The **Part** function encompasses the required functions for the object to be measured. When the **Part** function is activated, all of the irrelevant functions are hidden. You can save the required functions separately for every object of measurement.



- ▶ Tap **Part**
- > The green lettering of the function element indicates that the function is active
- > All other functions will be hidden. Only the functions that you have previously selected are displayed
- ▶ Tap the desired function
- > The function is activated



If you deactivate the **Part** function, then all of the active functions within the **Part** will also be deactivated.

13 Sending measured values to a computer

13.1 Configuring the measured value output

The product offers you various functions for manual or automatic transfer of the acquired measured values to a computer.

Prerequisites:

- The product is connected to the computer
- Receiving software is installed on the computer

The following steps are necessary in order to configure the measured value output:

- Configuring an interface
- Select the data format (only for RS-232)
- Adding the desired function elements to the function bar
- Selecting contents for the data transfer









If you connect a USB-to-RS232 connecting cable from the manufacturer STEINWALD datentechnik GmbH to the product, the data interface is configured automatically and is ready immediately. The data format **Steinwald** is used for measured value output. The settings are not configurable.

13.1.1 Functions for measured value output

The function bar provides the following functions for measured value output:

- **Manual output of measured values:** The user triggers transfer of the measured values manually.
- **Touch-probe triggered output of measured values:** The product automatically transfers the measured values each time the stylus is deflected.
- **Continuous output of measured values:** The product transfers the measured values continuously at intervals of approx. 200 ms

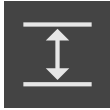
The overview shows which contents can be transferred with the respective functions:

Symbol	Function	Current position	Minimum	Maximum	Range
	Manual output of measured values				
	Touch-probe triggered output of measured values	✓	-	-	-
	Continuous output of measured values	✓	✓	✓	✓



See the **General Operation** chapter of this manual for a description of the function elements for the measured value output.

Further information: "Function elements", Page 36

13.1.2 Adding a function element



- ▶ Tap **Measure** in the main menu
- ▶ Drag an empty function bar field to the left and into the workspace
- > A dialog box for selecting the function element appears.
- ▶ Tap one of the following function elements:
 - **Manual output of measured values**
 - **Touch-probe triggered output of measured values**
 - **Continuous output of measured values**
- > The function element is now available.

13.1.3 Selecting contents for the data transfer

When configuring the function element, you select which contents are to be transferred to the computer.



- ▶ Drag the function element to the left into the workspace
- A dialog box for selecting the contents appears
- ▶ Tap the desired contents to select them
- The function element shows which contents are selected for data transfer; selected contents are highlighted green

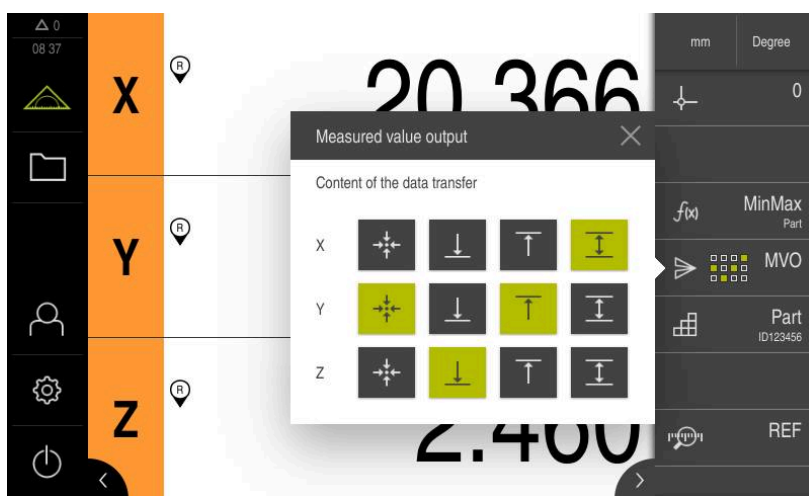

Figure 50: Display of selected contents for **Measured value output**



- ▶ Tap **Close**
- The selection is saved

i Ensure that the **MinMax** function covers all measured values that you want to send to a computer as part of the measured value output. If measured values are missing then the value 0 is sent.

Further information: "Configuring the MinMax function", Page 212

13.1.4 Remote access

You have various options for remote access. You can control the product via switching functions or you can send commands from a connected device via Ethernet oder RS-232.

Requirement: A connection has already been set up (e.g., GC/mvo)

Further information: "Activating the interface for Data transfer", Page 147

Activating the switching function

You assign digital inputs to specific actions in order to operate remote access via switching functions.

MVO	Action	Description
	Trigger function	The function is executed once.
	Start function	The function is started.
	Stop function	The function is terminated.

- ▶ In the **Measured value output** dialog box, swipe across the touchscreen from right to left
- ▶ Assign the digital input to the desired function

More than one input is available depending on the product variant.

Activating Remote commands

You activate commands in order to operate remote access via remote control commands. You can use default commands or your own commands.

MVO	Action	Description	Default command
	Trigger function	The function is executed once.	fctStartCmd1¹⁾
	Start function	The function is started.	fctStartCmd1¹⁾
	Stop function	The function is terminated.	fctStopCmd1¹⁾

1) The numbering is incremented sequentially.

- ▶ In the **Measured value output** dialog box, swipe twice across the touchscreen from right to left
- ▶ Tap **Reset all user commands to default values** or
- ▶ Tap the input field and enter your own command



13.2 Sending measured values to a computer

The **Measured value output** functions allow you to send measured values to a computer manually or automatically.

Requirement: Measured value output is configured

Further information: "Configuring the measured value output", Page 242

Sending measured values manually

- ▶ Conduct a measurement
 - ▶ Tap **Manual measured value output**
 - ▶ The measured values are sent to the computer once

Activating touch-probe triggered output of measured values



- ▶ Tap **Touch-probe triggered output of measured values**
- > The green icon shows that the function is active
- ▶ Conduct a measurement
- > The measured values are sent to the computer each time the stylus is deflected
- ▶ In order to deactivate the function, tap the **Touch-probe triggered output of measured values** function element again

Activating continuous output of measured values



- ▶ Tap **Continuous output of measured values**
- > The green icon shows that the function is active
- ▶ Conduct a measurement
- > The measured values are sent to the computer at a periodic interval
- ▶ In order to deactivate the function, tap the **Continuous output of measured values** function element again



In addition, you can activate automatic data transfer individually for each probing function.

Further information: "Configuring probing functions", Page 209

14 Starting remote access

14.1 Starting remote access via REST

Requirements:

- The product is connected to a network via Ethernet
- Data transfer via REST is activated in the settings

Further information: "Activating the interface for Data transfer", Page 147

Starting remote access

You can access the product from the remote station by specifying the IP address and the port.

- ▶ Read the IP address of the product from the settings
- ▶ Read the port from the settings
- ▶ Enter `http://IP address:port/GC/command` into the address line of a browser

14.2 Starting remote access via MQTT

Requirements:

- The product is connected to a network via Ethernet
- Data transfer via MQTT is activated in the settings

Further information: "Activating the interface for Data transfer", Page 147

Starting remote access

You can access the product from the remote station via the broker by specifying the broker address and the port.

- ▶ Read the IP address of the broker from the settings
- ▶ Read the port from the settings
- ▶ Enter a message with the appropriate topic (e.g., topic `GC/zeroC` and message `1`) at the remote station, in order to reset the first axis to zero

14.3 Starting remote access via RS-232

Requirements:

- The product is connected to the remote station via an RS-232 adapter
- Software is installed on the computer
- Data transfer via RS-232 is defined and activated in the settings

Further information: "Activating the interface for Data transfer", Page 147

Starting remote access

In transmissions via RS-232, you can use small text files to send remote commands.

- ▶ Select the same port settings on the remote station as on the product
- ▶ Enter the remote access command
- ▶ Use the appropriate command (e.g., Send File) depending on the software to send the remote access command to the product

15

What to do if ...

15.1 Overview

This chapter describes the causes of faults or malfunctions of the product and the appropriate corrective actions.



Make sure that you have read and understood the "Basic Operation" chapter before carrying out the actions described below.

Further information: "Basic Operation", Page 19

15.2 Exporting logging files

After a malfunction of the device, the logging files can be useful for HEIDENHAIN during troubleshooting. For this purpose, you have to export the logging files directly after restarting the device.

Exporting to a USB mass storage device

Prerequisite: The USB mass storage device must be connected.



- ▶ Tap **File management** in the main menu
- ▶ Tap **System** in the **Internal** memory location
- ▶ Drag the **Logging** folder to the right
- > The operating elements are displayed



- ▶ Tap **Copy to**
- ▶ In the dialog, select the desired storage location of the connected USB mass storage device
- ▶ Tap **Select**
- > The folder is copied



Send the folder to **service.ms-support@heidenhain.de**. Specify the model designation and the software version being used.

15.3 System or power failure

Operating system data can be corrupted in the following cases:

- System or power failure
- Switching off the product without shutting down the operating system

If the firmware is damaged, the product starts a Recovery System that displays short instructions on the screen.

With restoration, the Recovery System overwrites the damaged firmware with a new firmware previously saved to a USB mass storage device. During this procedure the settings of the product are deleted.

15.3.1 Restoring the firmware

- ▶ On a computer, create the folder "heidenhain" on a USB mass storage device (FAT32 format).
- ▶ In the "heidenhain" folder, create the folder "update"
- ▶ Copy the new firmware to the "update" folder
- ▶ Rename the firmware "recovery.dro"
- ▶ Switch off the product
- ▶ Connect a USB mass storage device to a USB port of the product
- ▶ Switch on the product
- > The product starts the Recovery System
- > The USB mass storage device is detected automatically
- > The firmware is installed automatically
- > After a successful update, the firmware is automatically renamed "recovery.dro.[yyyy.mm.dd.hh.mm]"
- ▶ Restart the product on completion of the installation
- > The product starts up with the factory defaults

15.3.2 Restoring settings

Reinstalling the firmware resets the product to the factory defaults. This deletes the settings, including the error compensation values and the activated software options.

To restore settings, you must either reconfigure them on the unit yourself or restore previously backed up settings on the unit.

i Software options that were active when the settings were backed up must be activated before restoring the settings on the product.

- ▶ Activating software options
Further information: "Activating Software options", Page 78
- ▶ Restoring settings
Further information: "Restoring settings", Page 183

15.4 Malfunctions

If faults or malfunctions that are not listed in the "Troubleshooting" table below occur during operation, refer to the machine tool builder's documentation or contact a HEIDENHAIN service agency.

15.4.1 Troubleshooting

i The following troubleshooting steps must be performed only by the personnel indicated in the table.
Further information: "Personnel qualification", Page 16

Fault	Cause of fault	Correction of fault	Personnel
The status LED remains dark after switch-on	There is no supply voltage	▶ Check the power cable	Electrical specialist
	The product does not function properly	▶ Contact a HEIDENHAIN service agency	Qualified personnel

Fault	Cause of fault	Correction of fault	Personnel
A blue screen appears when the unit starts up	Firmware error during startup	<ul style="list-style-type: none"> ▶ If this fault occurs for the first time, switch the product off and then on again ▶ If the fault recurs, contact a HEIDENHAIN service agency 	Qualified personnel
After startup, the product does not recognize any entries made on the touch-screen	Incorrect hardware initialization	<ul style="list-style-type: none"> ▶ Switch the product off and then on again 	Qualified personnel
Axes do not count despite movement of the encoder	Incorrect connection of the encoder	<ul style="list-style-type: none"> ▶ Correct the connection ▶ Contact the encoder manufacturer's service agency 	Qualified personnel
Axes are miscounting	Incorrect settings of the encoder	<ul style="list-style-type: none"> ▶ Check the encoder settings Page 88 	Qualified personnel
Connection to the network is not possible	Defective connection	<ul style="list-style-type: none"> ▶ Check the cable and the correct connection to X116 	Qualified personnel
	Incorrect settings of the network	<ul style="list-style-type: none"> ▶ Check the network settings Page 131 	Qualified personnel
Network error: Host is down	Incorrect setting of the network drive options	<ul style="list-style-type: none"> ▶ Add vers=2.1 in the connection options Page 132 	Qualified personnel
The connected USB mass storage device is not detected	Defective USB connection	<ul style="list-style-type: none"> ▶ Check the correct position of the USB mass storage device in the port ▶ Use another USB port 	Qualified personnel
	The type or formatting of the USB mass storage device is not supported	<ul style="list-style-type: none"> ▶ Use another USB mass storage device ▶ Format USB mass storage device with FAT32 	Qualified personnel
The unit starts in recovery mode (text only mode)	Firmware error during startup	<ul style="list-style-type: none"> ▶ If this fault occurs for the first time, switch the product off and then on again ▶ If the fault recurs, contact a HEIDENHAIN service agency 	Qualified personnel
User login is not possible	Password does not exist	<ul style="list-style-type: none"> ▶ As user with higher permission level, reset the password Page 128 ▶ To reset the OEM password, contact the HEIDENHAIN service agency 	Qualified personnel
Data transfer does not work	Incorrect data transfer setting	<ul style="list-style-type: none"> ▶ Check the configuration of the interface in the settings 	Qualified personnel

Fault	Cause of fault	Correction of fault	Personnel
Product does not respond to remote command	Incorrect command	<ul style="list-style-type: none"> ▶ Use the command <code>GC / commands</code> to read out the commands and compare them ▶ Reset all commands to the default values if necessary 	Qualified personnel
Product does not respond to remote command	Missing index	<ul style="list-style-type: none"> ▶ Use the command <code>GC / commands</code> to read out the commands ▶ Check whether "true" is in the "hasIndex" field of the sent command 	Qualified personnel
RS-232: Product does not respond to remote command	Syntax error in the command file	<ul style="list-style-type: none"> ▶ The texts in the command file must be written using the exact same syntax as on the product itself 	Qualified personnel
Product does not respond to remote command	Forgotten prefix	<ul style="list-style-type: none"> ▶ The prefix <code>GC /</code> must be placed before all commands 	Qualified personnel
Measured value output (MVO) via REST does not work	Connection has not been established	<ul style="list-style-type: none"> ▶ You must first set up a connection (e.g., using <code>GC / mvo</code>) before you can transmit measured values via REST 	Qualified personnel
MVO via REST: Received data cannot be seen after triggering the function via the remote control command	The wrong tab is open in the browser	<ul style="list-style-type: none"> ▶ The data are received on the tab that was used to set up the <code>GC / mvo</code> connection, and not on the tab of the remote control command transmitted for triggering the function 	Qualified personnel

IV Index

A

Accessories.....	52
Activating Software options.....	78
Adding a startup screen.....	118
Ambient conditions.....	189
Application example	
Dial gage.....	229
Formula.....	235
Assembly.....	57
Audio feedback.....	43
Axes.....	88, 93
Alias assignment for axis names.....	83

B

Backing up user files.....	121, 150
Blocking the function bar.....	163

C

Calibration.....	103
Cleaning.....	174
Cleaning the screen.....	174
Code number.....	26
commissioning.....	77
Computer.....	72
Configuring	
Dial gage function.....	223
Diameter/Radius function.....	216
Formula function.....	233
Function elements.....	39
Keyboard.....	133
Mastering function.....	220
Measured value output.....	242
MinMax function.....	212
network drive.....	132
Part function.....	238, 239
Presets.....	202
Probing functions.....	209
Relative function.....	218
Touchscreen.....	133
Configuring a touch probe.....	82
Configuring network settings.....	131
Connecting encoders.....	66
Connecting touch probes.....	67
Connection	
Computer.....	72
Connection overview.....	64
Coupled axis.....	115

D

Damage in transit.....	54
Data formats parameter	
parameter.....	135
Steinwald.....	135
date and time.....	81, 127

decimal places.....	81, 127
---------------------	---------

Device

installing.....	63
-----------------	----

Diagnostics

1 Vpp/11 μ App.....	177
EnDat.....	178

Dial gage..... 223 |

Activating axes.....	224
Activating remote control commands.....	227
Activating the switching function.....	226
Activating the trigger signal... ..	226
configuring.....	223
Entering values.....	225
General parameters.....	224
Opening the overview.....	228
Opening the single view.....	229
Overview.....	228
Single view.....	229

Documentation

Addendum.....	10
download.....	9
OEM.....	118
Dragging.....	21
Duo-Pos.....	59

E

Electrical specialist.....	16
----------------------------	----

Encoders

Axis parameter configuration (1 Vpp, 11 μ App).....	88
Configuring axis parameters (EnDat).....	87
Configuring axis parameters (TTL).....	93

EnDat

Errors and warnings.....	180
Functional reserves.....	179

energy saving mode.....	24
-------------------------	----

Error compensation

Calibration.....	103
linear error compensation.....	98
Methods.....	97
Nonlinear axis error compensation.....	101
performing.....	97
segmented linear error compensation.....	99
Squareness error compensation.. ..	114
Table of supporting points....	100

Error messages.....	41
---------------------	----

Errors and warnings.....	180
--------------------------	-----

F

File

copying.....	154
--------------	-----

deleting.....	155
exporting.....	156
importing.....	156
moving.....	154
opening.....	155
renaming.....	155

File management

file types.....	153
Menu.....	31
Short description.....	152

Firmware update.....	175
----------------------	-----

Folder

copying.....	154
creating.....	153
deleting.....	155
moving.....	153
renaming.....	154

Folders

managing.....	153
---------------	-----

Folder structure.....	153
-----------------------	-----

Formula.....	233, 235
--------------	----------

Activating a switching function....	235
-------------------------------------	-----

Activating remote control commands.....	235
---	-----

Formula function

Display of axes.....	233
----------------------	-----

Functional reserves.....	179
--------------------------	-----

function bar.....	36
-------------------	----

Function elements.....	36
------------------------	----

Add.....	38
----------	----

Adding.....	243
-------------	-----

Open.....	40
-----------	----

Save.....	39
-----------	----

G

Gestures

Dragging.....	21
Holding.....	21

Operation.....	20
----------------	----

Swiping.....	21
--------------	----

Tapping.....	20
--------------	----

Ground connection, 3-wire cable. . .	73
--------------------------------------	----

H

HEIDENHAIN encoders.....	84
--------------------------	----

Holding.....	21
--------------	----

I

Informational notes.....	13
--------------------------	----

Input devices

connect.....	72
--------------	----

Operation.....	20
----------------	----

Installation.....	63
-------------------	----

Installation Instructions.....	10
--------------------------------	----

Items supplied.....	51
---------------------	----

- L**
- Language
 - setting..... 27, 76, 124
 - License key
 - Activating..... 79
 - Entering..... 80
 - requesting..... 78
 - linear error compensation (LEC).. 98
 - Lissajous figure..... 177
- M**
- Main menu..... 29
 - Maintenance plan..... 175
 - Malfunctions..... 250
 - Mastering
 - Activating a switching function.... 221
 - Measure
 - Menu..... 30
 - Measured value output
 - Activating remote control commands..... 245
 - Activating the switching function..... 245
 - Configuring..... 242
 - Data format, selecting..... 134
 - Data format parameters..... 135
 - Data formats..... 138
 - Functions..... 243
 - Sending measured values..... 245
 - Measured-value output
 - Contents, selecting..... 244
 - Measurement
 - Acquiring the minimum, maximum, and range..... 214
 - Displaying the diameter..... 217
 - Mastering..... 222
 - Part management..... 241
 - Performing..... 207
 - Preparing..... 200
 - Relative..... 219
 - Touch probe..... 208
 - Menu
 - File management..... 31
 - Measure..... 30
 - Settings..... 33
 - Switch-off..... 34
 - User login..... 32
 - Messages
 - closing..... 42
 - viewing..... 41
 - MinMax
 - Activating a switching function.... 213
 - Activating remote control commands..... 213, 221
 - mounting..... 57
 - Duo-Pos stand..... 59
 - Multi-Pos holder..... 61
 - Multi-Pos stand..... 60
 - Single-Pos stand..... 58
 - Mouse actions
 - Configuring..... 133
 - Dragging..... 21
 - Holding..... 21
 - Operation..... 20
 - Swiping..... 21
 - Tapping..... 20
 - Moving functions on the function bar..... 35
 - MQTT..... 147
 - Multi-Pos..... 60, 61
- O**
- Obligations of the operating company..... 16
 - OEM
 - adding documentation..... 118
 - modifying startup screen..... 118
 - Operating elements
 - Add..... 23
 - Back..... 23
 - Close..... 23
 - Confirm..... 23
 - Drop-down list..... 23
 - Function elements..... 36
 - Main menu..... 29
 - Plusminus button..... 22
 - Screen keyboard..... 22
 - Slider..... 23
 - Slide switch..... 23
 - Toggle switch..... 23
 - Undo..... 23
 - Operating Instructions..... 10
 - updating..... 130
 - Operation
 - Audio feedback..... 43
 - Energy saving mode..... 24
 - Function elements..... 36
 - General operation..... 20
 - Gestures and mouse actions... 20
 - Messages..... 41
 - Operating elements..... 22
 - Touchscreen and input devices..... 20
 - Wizard..... 42
 - Operator..... 16
 - Overview of new and modified functions..... 8
- P**
- Part..... 238
 - Configuring..... 238, 239
 - Password..... 26
 - changing..... 77, 125, 129
 - creating..... 129
 - Default settings..... 26, 75, 123
 - User
 - Deleting..... 129
 - Personnel qualification..... 16
 - Pin layout
 - encoders..... 66
 - line voltage..... 73
 - network..... 72
 - switching inputs..... 68
 - Power connector..... 73
 - Preset..... 202
 - Remote access..... 205
 - Preset table
 - Creating..... 202
 - Product
 - commissioning..... 77
 - Setting up..... 126
 - Switch-off..... 25
 - Switch-on..... 24
 - Product data..... 188
- Q**
- Qualified personnel..... 16
- R**
- Reference mark search
 - activating..... 117
 - performing after startup.... 27, 76, 124, 201
 - Remote access..... 142
 - Commands..... 143
 - Starting..... 247
 - Remote control commands..... 143
 - Repackaging..... 55
 - REST..... 147
 - rounding methods..... 81, 127
 - RS-232..... 133
 - RS-232 adapters..... 54
- S**
- Safety precautions..... 12, 15
 - general..... 17
 - Peripheral devices..... 17
 - ScreenshotClient
 - Information..... 119
 - Scrolling the function bar..... 35
 - Segmented linear error compensation (SLEC)..... 99
 - Settings
 - Backing up..... 120, 149
 - menu..... 33
 - Restoring..... 183
 - Setup..... 126
 - Single-Pos..... 58
 - Storage..... 55
 - Swiping..... 21
 - Switch-off
 - Menu..... 34

Symbols and fonts used for marking text.....	13
Symbols on the product.....	17

T

Table of supporting points	
adjusting.....	101
creating.....	98, 99
Tapping.....	20
Touchscreen	
Configuring.....	133
Operation.....	20

U

units of measure.....	81, 127
Uploading license file.....	80
User	
Configuring.....	129
creating.....	129
Default password.....	26
Login.....	26
Logout.....	26
User login.....	25
user types.....	128
User files	
Restoring.....	182
User ID.....	129
User interface	
After start-up.....	28
Factory default setting.....	28
File management menu.....	31
Main menu.....	29
Measure menu.....	30
Settings menu.....	33
Switch-off menu.....	34
User login menu.....	32
User login.....	25, 32

W

Wiring switching inputs and outputs.....	68
Wizard.....	42
Workspace	
customize.....	35

V List of figures

Image 1:	Screen keyboard.....	22
Image 2:	The user interface in the product's factory default setting.....	28
Image 3:	User interface.....	29
Image 4:	Measure menu.....	30
Image 5:	File management menu.....	31
Image 6:	User login menu.....	32
Image 7:	Settings menu.....	33
Image 8:	Display of messages in the workspace.....	41
Image 9:	Display of messages in the wizard.....	42
Image 10:	Dimensions of rear panel of the product.....	57
Image 11:	Product mounted on Single-Pos stand.....	58
Image 12:	Cable routing on Single-Pos stand.....	58
Image 13:	Product mounted on Duo-Pos stand.....	59
Image 14:	Cable routing on Duo-Pos stand.....	59
Image 15:	Product mounted on Multi-Pos stand.....	60
Image 16:	Cable routing on Multi-Pos stand.....	60
Image 17:	Product mounted on Multi-Pos holder.....	61
Image 18:	Cable routing on Multi-Pos holder.....	61
Image 19:	Rear panel on devices with ID 1089181-01.....	65
Image 20:	Rear panel on devices with ID 1089182-01.....	65
Image 21:	The ScreenshotClient user interface.....	119
Image 22:	Example of a transfer for the X and Y axes with the active MinMax function in the data format Standard	136
Image 23:	Example of a transfer for the X and Y axes with the active MinMax function in the data format Steinwald	137
Image 24:	Data format MyFormat1.xml	138
Image 25:	File management menu.....	152
Image 26:	File management menu with preview image and file information.....	155
Image 27:	Example of functional reserves of a length gauge.....	179
Image 28:	Housing dimensions for devices with ID 1089181-xx.....	190
Image 29:	Housing dimensions for devices with ID 1089182-xx.....	191
Image 30:	Dimensions of the rear panel for devices with ID 1089181-xx.....	191
Image 31:	Housing dimensions of the rear panel for devices with ID 1089182-xx.....	192
Image 32:	Product dimensions with Single-Pos stand.....	192
Image 33:	Product dimensions with Duo-Pos stand.....	193
Image 34:	Product dimensions with Multi-Pos stand.....	193
Image 35:	Product dimensions with Multi-Pos holder.....	194
Image 36:	Measure menu.....	207
Image 37:	Measure menu with touch probe.....	208
Image 38:	Function bar with the function elements for probing functions.....	211
Image 39:	Measure menu with active MinMax function.....	214
Image 40:	Measure menu with active D/R function.....	217
Image 41:	Measure menu with activated Relative function.....	219
Image 42:	Measure menu with open Mastering function.....	222
Image 43:	Example of an absolute measurement.....	223

Image 44:	Example of a difference measurement.....	223
Image 45:	Example of a value input for an axis.....	225
Image 46:	Overview.....	228
Image 47:	Single view of the dial gage	229
Image 48:	Example of active Part function with selected functions.....	238
Image 49:	Measure menu with activated Part function.....	241
Image 50:	Display of selected contents for Measured value output	244

HEIDENHAIN

DR. JOHANNES HEIDENHAIN GmbH

Dr.-Johannes-Heidenhain-Straße 5

83301 Traunreut, Germany

☎ +49 8669 31-0

☎ +49 8669 32-5061

info@heidenhain.de

Technical support ☎ +49 8669 32-1000

Measuring systems ☎ +49 8669 31-3104

service.ms-support@heidenhain.de

NC support ☎ +49 8669 31-3101

service.nc-support@heidenhain.de

NC programming ☎ +49 8669 31-3103

service.nc-pgm@heidenhain.de

PLC programming ☎ +49 8669 31-3102

service.plc@heidenhain.de

APP programming ☎ +49 8669 31-3106

service.app@heidenhain.de

www.heidenhain.com

