



HEIDENHAIN



Operating Instructions

ND 1200 QUADRA-CHEK

Software Version
2.16

English (en)
4/2009

ND 1200 Introduction



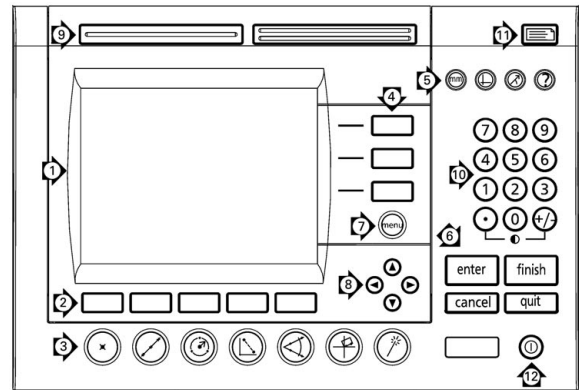

- 1 LCD screen
- 2 Soft keys
- 3 Measurement function keys
- 4 Axis keys
- 5 Mode selection keys
- 6 Command keys
- 7 Menu key
- 8 Arrow cursor keys
- 9 Fast track keys
- 10 Numeric keypad
- 11 Send key
- 12 LCD On/Off key

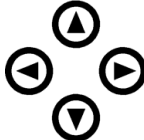

ND 1200 panel keys

Panel keys are used to initiate feature measurements, apply tolerances, send reports of measurement results and configure operational parameters.

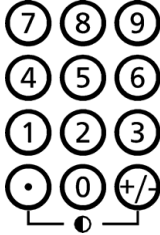
Panel function key	Panel key
<p>Soft keys: Functions change in support of the activities displayed on the LCD.</p>	
<p>Measure keys: Select a feature measurement type. Feature measurement types include points, lines, circles distances, angles, skew alignments and Measure Magic.</p>	
<p>Axis keys: Select axes for zeroing or presetting datums prior to measurements.</p>	
<p>Mode keys: Select unit of measure, datum, cartesian or polar coordinate system and help.</p>	
<p>Command keys: Control measurement and data entry processes.</p>	

Panel function key	Panel key
<p>Menu key: Displays five soft key menus for system setup, programming, extra functions clearing data and optional optical edge detector functions.</p>	
<p>Arrow cursor keys: Used to scroll through lists and navigate menus and setup screen data fields. The up arrow cursor key is also used to begin a feature construction process, as described later in the feature Constructions portion of this chapter.</p>	
<p>Fast track keys: Two programmable fast track keys are used to perform frequently used functions. These keys can easily be located by touch without taking your eyes off the part. By default the left fast track key is assigned the Enter key function and the right is assigned the Finish key function. Users can program either fast track key as described later in the Hotkeys portion of Chapter 2: Installation, Setup and Specifications.</p>	
<p>Numeric keypad: Used to enter numeric data. Additionally, the decimal point key and +/- key are used to adjust the contrast of the LCD display.</p>	
<p>Send key: Used to transmit measurement results to a computer, USB printer or USB flash drive.</p>	
<p>LCD On/Off key: Press the LCD on/off button to turn the LCD display off without removing power from the ND 1200. Press the button a second time to restore the LCD display. Additionally, the LCD On/Off key can be used to clear feature data, datums and skews.</p>	

ND 1200 rear panel

- 1 Serial number label
- 2 Power switch
- 3 Power cord connector and fuse holder
- 4 Power ground access
- 5 Measurement axis connectors
- 6 RS-232 serial port connector
- 7 Optical reference cable connector
- 8 Optical sensor cable connector
- 9 Not supported in the ND 1200
- 10 Tilt base mechanical tightness adjustment
- 11 Electrical Ratings label

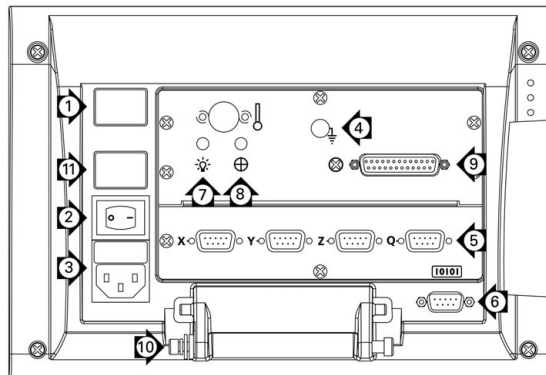

ND 1200 side panel

- 1 Speaker/headset jack
- 2 USB Type A connector
- 3 RJ-45 Foot switch/hand switch/keypad connector

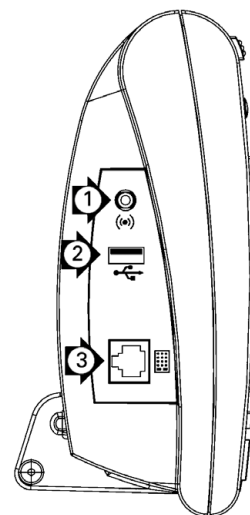

Information contained in this manual

This User's manual covers the operation, installation, setup and specifications of the ND 1200. Operating information is contained in chapter 1. Installation, setup instructions and specifications are contained in chapter 2.

Fonts used in this manual

The following fonts are used to indicate operator controls or to show emphasis:

- Operator controls - soft keys and other panel keys are shown in upper case.
- Emphasis - **Items of special interest** or **concepts** that are emphasized to the user are shown in bold type.

Showing sequences of key presses

The ND 1200 user performs sequences of soft key and panel key presses to measure part features and complete other tasks. These sequences are indicated using text as shown in the following example:

- Press the MENU key, press the EDGE soft key and then press the AUTO E soft key is sometimes abbreviated as:
- Press MENU/EDGE/AUTO E

Symbols within notes

Notes are marked with symbols on the left indicating the type, or potential severity of the information.



General Information

This is additional or supplementary information about an activity or concept.



Warning

This warns of a situation or condition that could lead to measurement errors, equipment malfunction or equipment damage. Do not proceed until the message is read and understood.



Caution - Risk of electric shock

This warns of a situation or condition that could lead to electrical shock and to personal injury or death. Do not proceed until the message is read and understood.

Safety considerations

General accepted safety precautions must be followed when operating the system. Failure to observe these precautions could result in damage to the equipment, or injury to personnel. It is understood that safety rules within individual companies vary. If a conflict exists between the material contained in this manual and the rules of a company using this system, the more stringent rules should take precedence.



The ND 1200 is equipped with a **3-wire** power plug that includes a separate ground connection. Always connect the power plug to a 3-wire grounded outlet. Use of 2-wire power plug adapters or any other connection accessories that remove the third grounded connection create a safety hazard and should not be permitted.



Unplug the ND 1200 from the power outlet and seek the assistance of a qualified service technician if:

- The power cord is frayed or damaged or the power plug is damaged
- Liquid is spilled or splashed onto the enclosure
- The ND 1200 has been dropped or the exterior has been damaged
- The ND 1200 exhibits degraded performance or indicates a need for service some other way

ND 1200 measurement axes

The ND 1200 DRO can display 2, 3, or 4 axes depending on the model purchased. DRO screen images used throughout this manual show different numbers of axes and are for illustration only.

Software version

The software version is shown in the About setup screen discussed later in chapter 2.

Cleaning

Use only a cloth dampened with water and a mild detergent for cleaning the exterior surfaces. Never use abrasive cleaners, and never use strong detergents or solvents. Only dampen the cloth, do not use a cleaning cloth that is dripping wet.

1 Operation 13

1.1 ND 1200 Overview	14
1.2 Basic Functions of the ND 1200	16
Switching on the ND 1200	16
Establishing a repeatable machine zero	17
Switching off the ND 1200	17
Panel key descriptions	18
LCD screen and soft key layout	22
DRO mode screen and soft keys	22
Feature evaluation mode screens and soft keys	23
Feature measurement mode screen and soft keys	24
ND 1200 Menus	25
1.3 Preparing to Measure	29
Power-up the ND 1200	29
Establish machine zero	29
Adjust LCD screen contrast	30
Select unit of measure	30
Select a datum	30
Select a coordinate system	30
Select the desired annotation	31
Toggle between forward and backward annotation	31
Select a probe type	32
Select crosshairs:	32
Select an optical edge probe	32
Calibrate the optical edge detector	33
Perform a Teach	33
Perform a D. Cal	33
Perform an X Cal	33
Align the part to a measurement axis	34
Perform a part alignment (Skew)	34
Establish a datum	35
Probe skew and part edge lines for point construction	35
Construct a datum point from line features	36
Zeroing the datum	36
Presetting the datum	37
1.4 Measuring Part Features	38
Part features	38
Feature list	38
Probing part features	39
Probing with crosshairs	39
Probing with optical edge detection	39
Probing with Measure Magic	40
Measuring features	41
Auto repeat	41
Measuring points	42
Measuring lines	43
Measuring circles	44
Measuring distances	45
Measuring angles	46

- 1.5 Creating Part Features 47
 - Created features 47
 - Creating features 47
 - Example of creating a feature 48
- 1.6 Constructing Part Features 49
 - Constructed features 49
 - Constructing features 49
 - Example of constructing a feature 50
 - 51
 - More feature construction examples 51
- 1.7 Tolerancing 54
 - Feature tolerances 54
 - Applying tolerances 55
 - Example of applying a tolerance 56
- 1.8 Programming 58
 - ND 1200 programs 58
 - Recording a program 58
 - Example of recording a program 59
 - Running a program 60
 - Example of running a program 61
 - Editing a program 62
 - Displaying program steps 62
 - Expanding and compressing a program steps 63
 - Changing a program step 64
 - Deleting a program step 67
 - Inserting new program steps 68
 - Copying a program 69
 - Deleting a program 70
 - Backing up programs 71
- 1.9 Reporting 72
 - Reporting 72
 - Sending reports 72
- 1.10 Error Indications 73
 - Scale errors 73

2 Installation, Setup and Specifications 75

2.1 ND 1200 Shipment Contents	76
Items included with the ND 1200	76
Optional items possibly included	76
Repackaging the ND 1200	77
2.2 Hardware Installation	78
Assembling the mounting stand	78
Benchtop location and mounting	78
Arm mounting (optional)	79
Connecting power	80
Connecting encoders	81
Connecting a computer	82
Connecting a headphone	82
Connecting a USB printer	82
Connecting an optional foot switch or remote keypad	83
Connecting and installing optical edge detection	84

2.3 Software setup	85
Setup menu	86
Setup example: entering the supervisor password	87
Order of setup	88
Language selection and product version	89
Supervisor password and program unlocking	90
Loading settings files and startup screens	91
Encoder configuration	92
Encoders screen	92
Misc screen	95
Optical edge detection setup	96
Edge menu tools	96
Misc screen	97
Stage squareness calibration	98
Error correction	99
Linear error correction (LEC)	100
Segmented linear error correction (SLEC)	102
Nonlinear error correction (NLEC)	106
NLEC by measuring points on a calibration grid	108
NLEC by importing an nlec.txt file	110
Saving NLEC correction data as an nlec.txt file	110
Measurement scaling for parts that expand or shrink	111
Scale Factor screen	111
Measurement configuration	112
Measure screen	112
Display formatting	115
Display screen	115
Hot key assignments	118
Hot keys screen	118
Print formatting	122
Print screen	122
Form chars screen	125
RS-232 port configuration	126
RS232 screen	126
USB port configuration	128
USB screen	128
Audio configuration	130
Sounds screen	130
Key repeat rate adjustment	131
Misc screen	131
Time and date settings	132
Clock screen	132
Saving settings files and programs	133
2.4 Specifications	134
Dimensions	135
Arm mount bracket	136

1

Operation

1.1 ND 1200 Overview

The ND 1200[®] is an advanced digital readout (DRO) system for performing high-precision 2, 3 or 4 axis measurements using analog or TTL encoders. The ND 1200 can be used with optical comparators, toolmaker's microscopes or video measurement systems as part of in-line production or in final quality inspection.

The following functions are available in the ND 1200:

- Reference mark evaluations for distance-coded and single reference encoders
- Linear, segmented linear and optional nonlinear error correction
- Scaling factor for parts that expand or shrink
- Multilingual LCD user interface: language is selected by the user
- soft key functions under LCD change to support different user activities
- Arrow cursor keys for easy navigation of lists and menus
- Measurement support function keys clearly marked with:
 - Unit of measure: mm or inch
 - Datum 1 or datum 2
 - Cartesian or polar coordinate system
- Skew compensation for part alignment prior to measurement, eliminating the need for time-consuming fixturing
- Two datums for absolute and incremental measurements
- Axis zero and preset keys for establishing datums
- Easy selection of feature measurement type using clearly marked measure function keys:
 - Points, lines, circles, distances, angles
 - Skew for part alignment
 - Measure Magic[®] for automatic feature type identification
- Feature measurement can include:
 - Dimensional measurements of geometric part features
 - Creation of features by entering dimensional data
 - Construction of new features from existing features
 - Applying tolerances

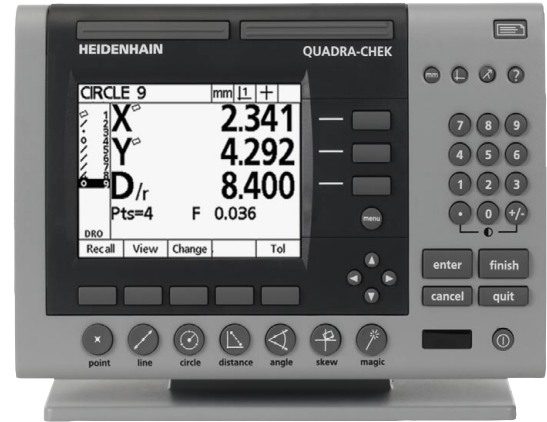

ND 1200 Front panel

- Number keypad with:
 - Number keys for data entry
 - Decimal point and +/- keys for data entry and LCD screen contrast adjustment
- User-defined hot keys that program panel and optional remote keys to initiate commonly used functions.
- User-defined programs made of the key-press sequences used to:
 - Perform measurements
 - Apply tolerances
 - Report results
- Reports of measurement results printed to USB printer, sent to PC over RS-232 connection or stored on USB drive
- User-defined programs and system settings stored on USB drive
- Speaker jack outputs for quiet or noisy environments
- Optional optical edge detection probes and enters feature data points at light to dark transitions on the comparator screen
- Optional remote foot switch and keypad facilitate measurement when the user is not close to the front panel

1.2 Basic Functions of the ND 1200

Switching on the ND 1200



Switch on the ND 1200. The POWER switch is located on the rear of the enclosure. After switching the power on, or after a power failure, the power-up screen will be displayed.



Press the FINISH key to advance from the power-up screen to the DRO.

Your ND 1200 is now ready for operation and is in the Current Position operating mode. Encoder position values will be displayed for all axes.



Power-up screen

Current Position		mm	↓	↑	+
X		0.000			
Y		0.000			
Z		0.000			
Q		0.000			
DRO					
Probe	Teach				

DRO screen

Establishing a repeatable machine zero

If your ND 1200 was configured to establish a machine zero upon power-up, a message will be displayed asking you to cross reference marks or enter hard-stop axis reference positions. The machine zero is used by the ND 1200 to apply error correction data as measurements are performed. To establish a repeatable machine zero you must either:

- ▶ Move the stage to have encoder reference mark crossings recognized on each axis **or**
- ▶ move the stage to the hard-stop reference position and press ENTER on each axis when no encoder reference marks are present.



If the requirement to cross reference marks is bypassed by pressing the CANCEL soft key, error correction data that might be stored in your ND 1200 **will not be applied**.

Switching off the ND 1200









Switch the ND 1200 off. The parameter settings, error compensation tables and recorded programs that have been saved during operation will be retained in memory.



Your ND 1200 might also have been configured to retain measurement results across power cycles







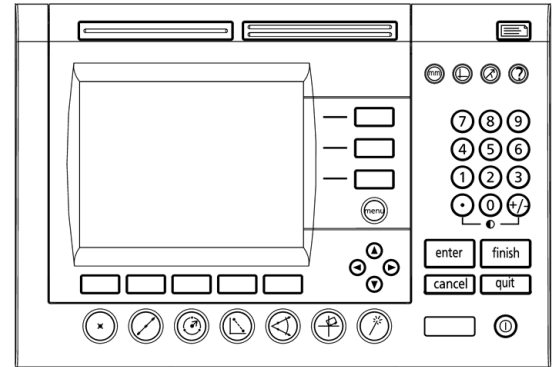

Panel key descriptions



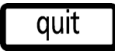

Descriptions of panel key functions are provided in the following pages for MEASUREMENT function, COMMAND, MODE selection, AXIS, FAST TRACK, SEND, LCD ON/OFF, and MENU keys. Soft key functions are also described later in the next section as part of screen and soft key layout descriptions.

MEASURE keys	Function
	Measure point: Press the POINT key once to measure one point, or twice to use auto repeat to measure a series of points. A minimum of one data point is required to measure a point.
	Measure line: Press the LINE key once to measure one line, or twice to use auto repeat to measure a series of lines. A minimum of two data points are required to measure a line.
	Measure circle: Press the CIRCLE key once to measure one circle, or twice to use auto repeat to measure a series of circles. A minimum of three data points are required to measure a circle.
	Measure distance: Press the DISTANCE key once to measure one distance, or twice to use auto repeat to measure a series of distances. Two points are required to measure a distance.
	Measure angle: Press the ANGLE key once to measure one angle, or twice to use auto repeat to measure a series of angles. Collect a minimum of two data points, then press the ENTER key on each leg of an angle.
	Align part: Press the SKEW key to compensate electronically for non-square part alignment on the primary axis.
	Use Measure Magic: Press the MEASURE MAGIC key to automatically measure any geometric feature or twice to measure a series of like features. Collect the desired points and press the FINISH key; Measure Magic analyzes the data and determines the feature type.

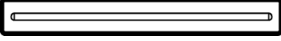

ND 1200 Panel keys

COMMAND keys	Function
	Enter data: Press the ENTER key to enter points during feature measurements or to enter values into configuration fields. Pressing the ENTER key indicates that data from a measurement or in a field is ready for use.
	Finish a measurement: Press the FINISH key to complete a feature measurement. Pressing the FINISH key a second time returns the user to the DRO screen.
	Delete data or features: Press the CANCEL key to delete the last point entered, data in configuration fields or any highlighted feature from the feature list.
	Quit current activity: Press the QUIT key to abandon the current task and return to the DRO screen or to exit the feature list.
MODE keys	Function
	Select unit of measure: Press the UNIT OF MEASURE key to toggle between millimeters and inches . The current unit of measure is displayed in the upper right corner of the screen.
	Select a datum: Press the DATUM key to toggle between datum 1 and datum 2 . The current datum number is displayed in the upper right corner of the screen.
	Select a coordinate system: Press the COORDINATE key to toggle between Cartesian and polar coordinate systems.
AXIS keys	Function
	Zero an axis: Press the axis key to the right of the desired axis to zero the axis position value when establishing a zero datum.
	Preset an axis or axes: Press one or more axis keys to the right of the desired axis or axes when presetting axis position values for a new datum.
	

FAST TRACK keys	Function
	Left frequently used function: Press the left WIDE key to initiate the function programmed for this key. The factory default function for this key is ENTER.
	Right frequently used function: Press the right WIDE key to initiate the function programmed for this key. The factory default function for this key is FINISH.
SEND key	Function
	Transmit measurement results: Press the SEND key to transmit measurement data to a computer, a USB printer or a USB memory drive.
LCD ON/OFF key	Function
	Turn the LCD off or clear data: Press the LCD ON/OFF key to toggle between LCD on and LCD off, or to clear feature data, datums and part alignments (skews).
MENU key	Function
	<p>Display soft key menus: Press the MENU key to display the titles of ND 1200 menus above the soft keys. Menus include:</p> <ul style="list-style-type: none"> ■ Setup: Used by supervisors to configure the operational characteristics of the system. ■ Prog: Used by operators and supervisors to create and recall programs of recorded measurement steps. ■ Extra: Used by operators to conduct measurements and send measurement result data. ■ Clear: Used by operators to clear measurement data and datums. ■ Edge: Used by operators and supervisors to install, calibrate and select optical edge detectors.

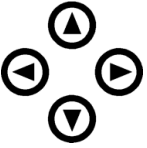
ARROW CURSOR keys**Function**

Navigate menus and setup screen data fields. The up arrow cursor key is also used to begin a feature construction process.

LCD screen and soft key layout

ND 1200 LCD screens display information in one of four operating modes:

- **DRO mode** displays current positions of axes
- **Feature evaluation mode** screens can be toggled between two displays that show all measurement results and the data cloud of collected points
- **Feature measurement mode** displays feature type, points collected and current positions of axes during measurements
- **Setup mode** displays ND 1200 Installation and setup screens

Soft keys change to support activities shown on the screens.

 Installation and setup screens and soft keys are described later in Chapter 2: Installation, Setup and Specifications.

DRO mode screen and soft keys

The DRO screen shows:

- Feature list of measured features on the left side
- Unit of measure, current datum and probe type in the upper right corner
- The current positions of all axes
- Part alignment status: a small rectangle over the axis letter indicates that the part is aligned to a measurement axis (a skew was performed)
- Soft key functions for selecting a probe type and teaching (calibrating) optical edge detection (optional)

DRO soft keys	Function
Probe	Toggles between crosshair and optical edge detection probes
Teach	Initiates the optical edge detection light-calibration wizard. You will be guided through the process by messages shown on the screen

Current Position		mm	1	+	
X		1.152			
Y		7.776			
Z		0.000			
Q		0.000			
DRO					
Probe	Teach				

DRO current position screen showing current axis positions

Feature evaluation mode screens and soft keys

The feature evaluation screens can be toggled between two displays by pressing the VIEW soft key to show:

- Feature list of measured features on the left side
- Unit of measure, current datum and probe type in the upper right corner
- The feature type and number of the highlighted feature
- Feature position
- Geometric and dimensional values such as diameter, length or angle
- Number of data points used to define the feature
- Form error
- Parent features used if the feature was constructed
- An indication that the feature was created if applicable
- Data cloud of collected data points used to define the feature

DRO soft keys	Function
Recall	Displays a different feature from the feature list by specifying its feature number.
View	Toggles between the default screen showing axis values and the screen showing data points collected to define the feature.
Change	Shows alternative fit algorithms for the current feature type, such as LSBF (least squares best fit) and ISO.
Zoom	Changes magnification when viewing the data cloud of collected data points.
Tol	Displays the alternative tolerances that can be applied to the current feature.



Tolerances are discussed later in this chapter.

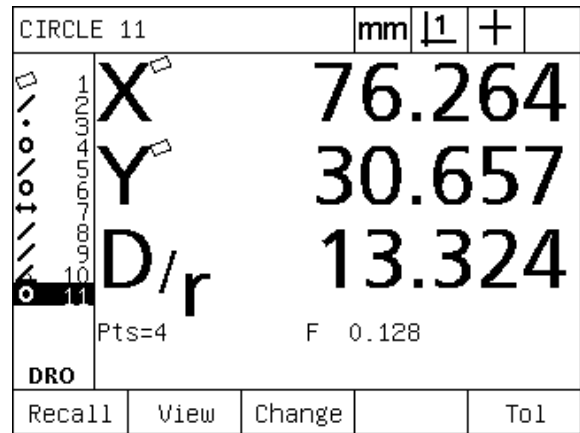

Feature evaluation mode screen showing feature values

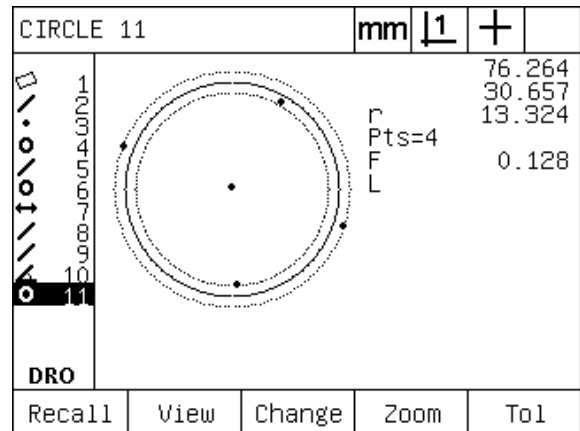

Feature evaluation mode screen showing data points

Feature measurement mode screen and soft keys

The feature measurement screen is displayed after initiating a feature measurement by pressing a MEASUREMENT key and shows:

- Feature list of measured features on the left side
- Unit of measure, current datum and probe type in the upper right corner
- The feature type being probed and the number of collected data points
- The current positions of all axes

DRO soft keys	Function
Probe	Toggles between crosshair and optical edge detection probes (available only with optical edge detection option).
Recall	Recalls the first parent feature of a new feature construction.
Create	Displays fields for entering data to create the specified feature type.
Const	Initiates a new feature construction.

Probe Line		mm	1	+	
Pts	X	19.225			
2	Y	45.062			
	Z	0.000			
	Q	0.000			
DRO					
Probe	Recall	Create	Constr		

Feature measurement mode screen showing feature type and points collected

ND 1200 Menus



Press the MENU key to display menu titles over the soft keys at the bottom of the LCD screen. Press a menu soft key to display the corresponding menu screen. Menus include:

SETUP menu

SETUP functions

About	mm	1	+	
About	Language			
Display				
Encoders				
Hot Keys				
Print				
Form Chars	v2.16 Beta 42			
RS232	(c)2009 Metronics, Inc.			
USB	XYZQ, OE, NLEC, Tol			
Measure	MO			
	BL 3.00 SN: 123456			

Press the SETUP menu soft key to display the collection of SETUP screens used to configure the ND 1200. Use of the setup menu is explained later in Chapter 2: Installation, Setup and Specifications.

Current Position		mm	1	+	
X					0.104
Y					6.643
Z					0.000
Q					0.000
DRO					
Setup	Prog	Extra	Clear	Edge	

Menu titles are displayed over soft keys at the bottom of the LCD screen



Access to setup menu configuration data fields is password restricted to supervisors and other technically qualified personnel. Configuration mistakes can result in serious measurement errors.

PROG menu

PROG functions

Programs	mm	1	+	
1				
Record	Run	Edit	Copy	Delete

Press the PROG soft key to display the PROGRAMS screen and soft keys for program functions. Soft keys include:

Record

Records a program of user key presses that can be played back later.

Run

Plays a program of recorded key presses.

Edit

Displays program steps for editing.

Copy

Copies a program to be edited and saved under a new name.

Delete

Deletes a program.

EXTRA menu	EXTRA functions
	<p>Press the EXTRA soft key to display the EXTRA pop-up menu. The EXTRA menu is used perform many measurement and data transmission functions. Highlight a function and then press the ENTER key. EXTRA menu functions include:</p>
Annot	Toggles between forward and backward annotation.
DMS/DD	Toggles between the display of degrees, minutes, seconds and decimal degrees.
MCS	Clears datums and re-establishes machine coordinates.
MinMax	Collects and stores minimum and maximum values until the FINISH key is pressed.
Preset	Sets the position of one or more axes to specified values.
Preset!	Recalls the last preset position.
Prt RS	Sends current data to the RS-232 serial port.
Run	Runs the last program.
Send 2	Sends current X, Y data to a printer, USB drive or computer.
Send 3	Sends current X, Y, Z data to a printer, USB drive or computer.
Send 4	Sends current X, Y, Z, Q data to a printer, USB drive or computer.
Send D	Sends current diameter to a printer, USB drive or computer.

EXTRA menu	EXTRA functions
Send F	Sends current form error to a printer, USB drive or computer.
Send L	Sends current distance to a printer, USB drive or computer.
Send Q	Sends current Q-axis value to a printer, USB drive or computer.
Send R	Sends current radius to a printer, USB drive or computer.
Send X	Sends current X-axis value to a printer, USB drive or computer.
Send Y	Sends current Y-axis value to a printer, USB drive or computer.
Send Z	Sends current Z-axis value to a printer, USB drive or computer.
Send <	Sends current angle to a printer, USB drive or computer.
Time	Displays the current date and time.
Zero 2	Zeros X and Y axes in the current datum.
Zero Q	Zeros Q-axis protractor value.

CLEAR menu	CLEAR functions
------------	-----------------

Current Position	mm	↓	↑	+
X	0.104			
Y	6.643			
Z	0.000			
Q	0.000			
DRO				
Clr Ft	Clr Sk	Clr All		

Press the **clear** soft key to display soft key selections for clearing data. Soft keys include:

CLEAR menu	CLEAR functions
Clr Ft	Clears feature data from the feature list.
Clr Sk	Clears the part alignment (skew). Clearing the skew does not clear any datums that have been established.
Clr All	Clears feature, datum and part alignment data.

EDGE menu	EDGE functions
-----------	----------------

Current Position	mm	1	+	
X	0.104			
Y	6.643			
Z	0.000			
Q	0.000			
DRO				
Teach	D. Cal	Install	X Cal	Auto E

Press the EDGE soft key to display edge detection soft key functions. Soft keys include:

Teach	Calibrates edge detection for typical light to dark edge transitions.
D. Cal	Calibrates edge detection for fuzzy or irregular light to dark edge transitions.
Install	Installs edge detection.
X Cal	Calibrates crosshair and edge detector probes to indicate identical positions.
Auto E	Toggles between automatic and manual edge detection.

1.3 Preparing to Measure

Power-up the ND 1200

- ▶ Switch on the ND 1200. The POWER switch is located on the rear of the enclosure. After switching the power on, or after a power failure, the power-up screen will be displayed. See "Switching on the ND 1200" on page 16.
- ▶ Press the FINISH key to advance from the power-up screen to the DRO.

If your ND 1200 was configured to establish a machine zero upon powering up, a message will be displayed asking you to cross reference marks or specify axis references manually.

Establish machine zero

A repeatable machine zero is required if you plan to retain feature measurement results across a power cycle or if error correction will be applied to your measurements.



Often feature data retention and error correction are not desired. In these cases, it is not necessary to establish a machine zero.

To establish a repeatable machine zero:

- ▶ Move the stage to have reference mark crossings recognized on each axis **or**
- ▶ move the stage to the hard-stop reference position and press ENTER on each axis when no encoder reference marks are present.

Adjust LCD screen contrast

If necessary, adjust the LCD screen contrast using the decimal point and +/- keys located on the numeric keypad.

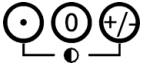

- ▶ Press the DECIMAL POINT key to increase the contrast
- ▶ Press the +/- key to decrease the contrast

Select unit of measure



- ▶ Press the UNIT OF MEASURE key to toggle between millimeters and inches.

Select a datum



- ▶ Press the DATUM key to toggle between Datum 1 and Datum 2.

Select a coordinate system



- ▶ Press the COORDINATE key to toggle between Cartesian and polar coordinate systems.

Select the desired annotation

Annotation determines the number of measurement points collected for each feature type.

- **Forward annotation:** Use forward annotation to require a previously specified number of points for each feature type. When using forward annotation, the number of required points is shown in the top left corner of the screen. As points are entered, the number of required points counts down. Since a fixed number of points is required using forward annotation, the system automatically completes the measurement and displays the feature after the last required point is entered. It is not necessary to press the FINISH key in forward annotation measurements to complete a measurement.
- **Backward annotation:** Use backward annotation to allow the operator to determine the number of points for each feature. Backward annotation displays the total number of points collected in the top left corner of the screen as they are entered. It is necessary to press the FINISH key to complete backward annotation measurements.

Toggle between forward and backward annotation

- ▶ Press MENU/EXTRA/ANNOT/ENTER

Select a probe type

Features are probed with crosshairs or with optional optical edge detection. Optical edge detection can be configured as manual or automatic point entry.



Skip these probe selection instructions if your ND 1200 does not include the optical edge detection option.

Select crosshairs:

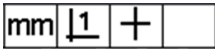

▶ Press the PROBE soft key if necessary to select the crosshair probe. The crosshair symbol will be shown in the upper right corner of the screen.

Select an optical edge probe

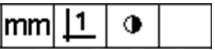

▶ Press the PROBE soft key if necessary to display an optical probe symbol in the upper right corner of the screen. The manual point entry optical probe symbol is shown here.

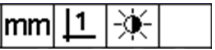

▶ Toggle the optical probe between **manual and automatic point entry** by pressing the key sequence: MENU/EDGE/AUTO E.

Current Position		mm	1	+
X		1.152		
Y		7.776		
Z		0.000		
Q		0.000		
DRO				
Probe	Teach			

Press the PROBE soft key to select a probe type

Calibrate the optical edge detector

The optical edge detector must be calibrated to correctly recognize light to dark part edge transitions. Calibration should be performed after startup, when the part is changed, when magnification is changed, when measuring a part with fuzzy or irregular edges, and when the optical system is repositioned or replaced.



Skip these calibration instructions if your ND 1200 does not include the optical edge detection option.

Three types of calibrations can be performed:

- **Teach:** Teach calibration should be performed after each startup or whenever the part or magnification level changes. Teach calibration trains the ND 1200 to recognize the light to dark transitions on your comparator. Any change in the comparator light conditions should be followed by a teach calibration.
- **D. Cal:** Distance Calibration should be performed when measuring parts with poorly defined edges. Perform a distance calibration to fine tune the edge detector for fuzzy or irregular edges and for thick parts or parts with rounded edges.
- **X Cal:** Cross calibration compensates for the position offset between the crosshairs and the edge detector sensor to produce consistent results for all measuring probes. Perform cross calibrations each time the edge detector sensor is changed or repositioned.

Perform a Teach

- ▶ Press the TEACH soft key.
- ▶ Follow instructions displayed on the screen.

Perform a D. Cal

- ▶ Press MENU/EDGE/D. CAL
- ▶ Follow instructions displayed on the screen.

Perform an X Cal

- ▶ Press MENU/EDGE/X CAL
- ▶ Follow instructions displayed on the screen.

Align the part to a measurement axis

Accurate measurements require the part to be perfectly aligned along a measurement axis. Misaligned parts result in cosine measurement errors. Use the SKEW function to convert machine coordinates to part coordinates and compensate for part misalignment. Measure a skew each time a new part is mounted on the measuring system.

Measure a skew line by probing a straight edge of the part on a major measurement axis. A minimum of two points is required for a line, but probing more points will improve accuracy.



The alignment is performed on a part edge here as an example. Part alignments can be made on part features other than an edge. For example, a line constructed between the centers of two holes could be aligned to a measurement axis if desired.



The skew alignment edge or line must be oriented within 45 degrees of the measurement axis.

Perform a part alignment (Skew)



- ▶ Press the SKEW key.
- ▶ Probe a minimum of two points along the part edge. In the example shown here, the part is aligned to the X-axis by probing three points along the bottom edge of the part.



The part could alternately have been aligned along a vertical edge to the Y-axis.

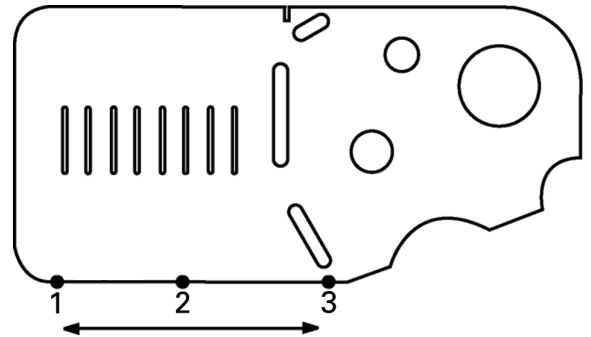

Three points are probed to align the bottom edge of a part to the X-axis

Establish a datum

Establish a reference datum once the part is skewed. Two datums can be created in the ND 1200. Typically, datum 1 is a zero reference and used as an absolute or primary datum, while datum 2 is used as an incremental or temporary datum.

Datums can be set to zero or can be preset to specified values.

Two methods can be used to establish a datum:

- Zero or preset the X and Y axes on a point or on the center point of a circle
- Zero or preset the X and Y axes on a point or on a center point constructed from parent features

While the datum can be created from a probed point or from the center point of a probed circle, it is more commonly created from a point that has been constructed from important parent features, such as the skew alignment line and a second part edge line. An example of a datum created from a constructed point is shown below.



Constructions and the feature measurements necessary for constructions are discussed in detail later in this chapter. However, a brief example of constructions is shown here to adequately cover the topic.

Probe skew and part edge lines for point construction

Probe a Skew alignment line along the bottom of the part and probe a line on the left side of the part. These lines will be used to construct a datum point.

Perform skew part alignment to the X-axis on the bottom edge



- ▶ Press the SKEW key.
- ▶ Probe 3 points along the bottom edge (points 1, 2 and 3).
- ▶ Press the FINISH key to create the skew line.

Probe a line along the left edge



- ▶ Press the LINE key.
- ▶ Probe 3 points along the left edge (points 4, 5 and 6).
- ▶ Press the FINISH key to create the second line.

The skew and left edge lines will now be shown in the feature list on the left side of the DRO screen. The point construction using these parent features is shown on the next page.

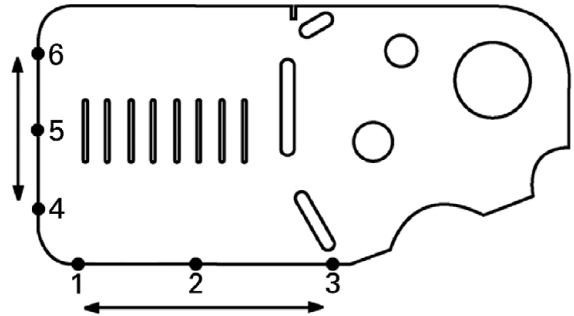

A skew is performed along the bottom and a line is probed on the left side

Construct a datum point from line features

Construct a point from the skew line and the left edge line to create a datum.



- ▶ Press the POINT key. The Probe Point screen will be displayed.
- ▶ Press UP ARROW/ENTER to start the construction and select the line feature (2). The screen will change to the Construct Point screen, feature 2 will be checked and skew line feature 1 will become highlighted.
- ▶ Press ENTER to check feature 1.
- ▶ Press the FINISH key to complete the point construction from the intersection of the two checked parent line features.

Probe Point		mm	1	+
Pts	X	-	28.572	
2/1	Y		13.544	
	Z		0.000	
	Q		0.000	
DRO				
Probe	Recall	Create	Constr	

POINT key is pressed

Construct Point		mm	1	+
✓ 2	X	0.000		
	Y	0.000		
	△	0°00'		
Pts=3 F 0.507				
DRO				
	Recall	View	Probe	

Features are selected

POINT 3		mm	1	+
3/1	X	-	26.448	
	Y		0.000	
	Z		0.000	
Fts=2				
DRO From 2,1				
Recall	View	Change		Tol

Point is constructed

Zeroing the datum

Datums can be zeroed or preset. This example creates a zero reference datum from a point feature.



- ▶ With the datum point highlighted in the feature list, press the DATUM key if necessary to select the desired datum in the upper right corner of the screen.
- ▶ Press the X and Y AXIS keys to zero the point position.

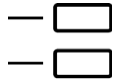

POINT 3		mm	1	+
3/1	X	-	26.448	
	Y		0.000	
	Z		0.000	
Fts=2				
DRO From 2,1				
Recall	View	Change		Tol

Point is highlighted

POINT 3		mm	1	+
3/1	X	0.000		
	Y	0.000		
	Z	0.000		
Fts=2				
DRO From 2,1				
Recall	View			Tol

Point is zeroed as datum

Presetting the datum

Datums can be zeroed or preset. This example creates a preset reference datum from a point feature.



- ▶ With the datum point highlighted in the feature list, press the DATUM key if necessary to select the desired datum in the upper right corner of the screen.
- ▶ Press MENU/EXTRA/PRESET/ENTER to display the preset screen.
- ▶ Press the desired AXIS key and enter the preset value for the axis.
- ▶ Press another AXIS key if desired and enter the preset value for that axis.
- ▶ Press the FINISH key to preset the datum to the specified values.

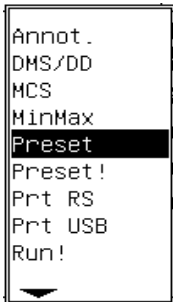
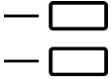

PRESET Selected from EXTRA menu

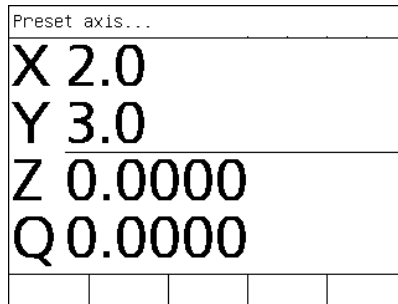

Preset values are entered

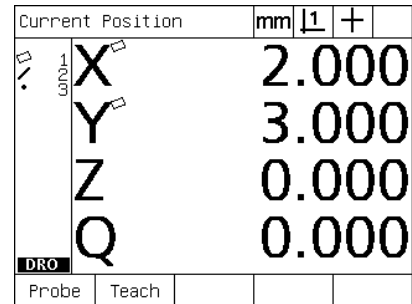

Point is preset as datum

1.4 Measuring Part Features

Part features

Features are measured by probing data points that characterize the dimensional geometry of the part. For example, several points probed around the circumference of a circle results in numeric and graphic representations of the circle geometry. Throughout this manual, a measured geometry is referred to as a **feature** and can alternately be displayed numerically or graphically by pressing the VIEW soft key. There are several types of features and each has different dimensional information. For example, a circle has a center point position and a radius, a point has a position, and an angle has degrees.

CIRCLE 11		mm	1	+
X		76.264		
Y		30.657		
D/r		13.324		
Pts=4		F 0.128		
DRO				
Recall	View	Change		Tol

Feature displayed numerically

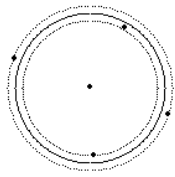
CIRCLE 11		mm	1	+
		76.264		
		30.657		
		13.324		
		0.128		
Pts=4				
DRO				
Recall	View	Change	Zoom	Tol

Feature displayed graphically

Feature list

Each feature is added to the feature list when it is measured. The feature list shows all features measured on the left side of the LCD screen and is visible in DRO and measuring modes. Each feature is identified by a number and an icon indicating its type (i.e. circle, line, etc.). Up to 100 features can be added to the feature list. Use the ARROW CURSOR keys to scroll through the list. Highlight the desired feature to recall, print or send the feature data to a computer or a USB drive. Select parent features from the feature list to construct new features. Delete features using the CANCEL key or the LCD ON/OFF key. In general, the user should delete old features, datums, and skews from the feature list before each new measurement session.

Probing part features

Part features can be probed with crosshairs or with optional optical edge detection. If optical edge detection is used, points can be entered manually or automatically.

Probing with crosshairs

- ▶ Move the stage to position the crosshairs over the desired feature point and press the ENTER key. The probed point will be added to the points required for the feature.

Probing with optical edge detection

Probing with optical edge detection speeds the measurement process and increases measurement consistency. Two general guidelines should be followed when probing with optical edge detection:

- Move the stage to make edge crossings as close to perpendicular as possible.
- Move the stage at slow to moderate speeds when possible. In general, slower edge crossings are slightly more accurate.

To probe with edge detection:



Skip these probing instructions if your ND 1200 does not include the optical edge detection option.

- ▶ Move the stage to pass the optical sensor over the edge.
- ▶ When manual point entry is used, the ND 1200 will beep when an edge is recognized. Press the ENTER key to add the point to the number required for the measurement.
- ▶ When automatic point entry (Auto E) is used, the ND 1200 will beep when an edge is recognized and will add the point to the number required for the feature measurement automatically.

Probing with Measure Magic

Measure Magic analyzes feature data collected by part probing and automatically determines the feature type. Measure Magic supports the following feature types in the ND 1200:

- Points
- Lines
- Circles
- Distances
- Angles

When Measure Magic is used, and more than the minimum number of points required to define a feature type are collected, the feature type can be changed manually by the user if the wrong feature type is assigned.

To probe a feature using measure magic:



- ▶ Press the MEASURE MAGIC MEASUREMENT key. The Probe Feature screen will be displayed. Press the key twice to measure a series of features using auto repeat.
- ▶ Probe points on the desired feature and then press the Finish key.

If the wrong feature type is shown on the screen:

- ▶ Press the CHANGE soft key. The alternative feature types will be shown over soft keys at the bottom of the screen.
- ▶ Press the correct feature type soft key. The correct feature type will be displayed in the feature list.

CIRCLE 4		mm	1	+
X	9.343			
Y	6.877			
D/r	57.518			
Pts=5	F 4.777			
DRO				
Recall	View	Change		To1

Press the CHANGE soft key

LINE 4		mm	1	+
X	25.440			
Y	26.407			
Δ	139°46'			
Pts=5	F 9.557			
DRO				
	Line	Circle	b	

Press the correct feature type soft key

LINE 4		mm	1	+
X	25.440			
Y	26.407			
Δ	139°46'			
Pts=5	F 9.557			
DRO				
Recall	View	Change	b	To1

The correct feature type is displayed

Measuring features

The ND 1200 measures point, line, circle, distance and angle features. To measure a feature using **backward annotation** (See "Select the desired annotation" on page 31):

- ▶ Press the desired feature MEASUREMENT key
- ▶ Probe the required points
- ▶ Press the FINISH key

Auto repeat

Use auto repeat to measure several features of the same type (such as a series of circles). Press the desired feature MEASUREMENT key twice to activate auto repeat. For example, press the CIRCLE MEASUREMENT key twice to measure a series of circles. When auto repeat is selected, the Probe feature screen becomes the Probe features screen. For example, the Probe Circle screen becomes probe Circles screens as shown below.

Probe Circle		mm	1	+
Pts	X	-	1.327	
	Y	33.217		
	Z	0.000		
	Q	0.000		
DRO				
Probe	Recall	Create	Constr	

Probe Circle screen

Probe Circles		mm	1	+
Pts	X	-	1.327	
	Y	33.217		
	Z	0.000		
	Q	0.000		
DRO				
Probe	Recall	Create	Constr	

Probe Circles screen

Use **auto repeat and forward annotation** to speed up repetitive measurements. For example, the measurement of a dozen circles requires the user to press the CIRCLE MEASUREMENT key before measuring each circle and press the FINISH key for each measurement. The same measurements using auto repeat and forward annotation requires the user to press the CIRCLE MEASUREMENT key twice before and the FINISH key once after measuring all 12 circles. Pressing the FINISH key turns off auto repeat.



Examples of measurements are shown in the next few pages and will use crosshairs to probe points on the 2-D demo part shipped with each ND 1200.



Examples show feature probing and measurement using forward annotation with the factory default minimum points probed for each feature type. The number of required points for each feature type can be changed in the Measure setup screen discussed later in Chapter 2: Installation, Setup and Specifications.

Measuring points

Points are the simplest features to measure. Only one point is required to define the location of a point. A maximum of 100 points can be probed and will be averaged by the system to measure a single point.



- ▶ Press the POINT MEASUREMENT key. The Probe Point screen will be displayed. Press the key twice to measure a series of points using auto repeat.
- ▶ Move the stage to position the crosshairs over the desired point location and press the ENTER key.
- ▶ Press the FINISH key to complete the measurement. The point position will be shown and the point feature will be added to the feature list.

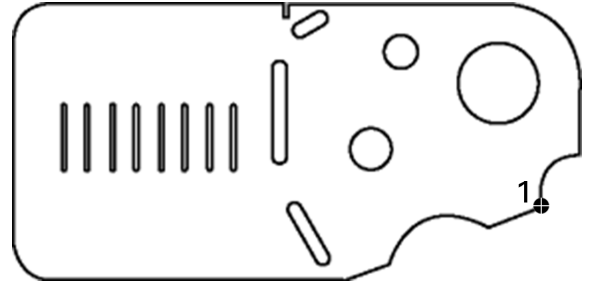

A point is probed on the part

POINT 4		mm	1	+
X		83.251		
Y		11.294		
Z		0.000		
Pts=1		F 0.000		
DRO				
Recall	View			To1

The point position is shown and the point feature is added to the feature list

Measuring lines

A minimum of 2 points are required to measure a line. A maximum of 100 points can be probed and will be processed by a fit algorithm to define the line.



- ▶ Press the LINE MEASUREMENT key. The Probe Line screen will be displayed. Press the key twice to measure a series of lines using auto repeat.
- ▶ Move the stage to position the crosshairs over an end point of the line and press the ENTER key.
- ▶ Move the stage to position the crosshairs over the other end point of the line and press the ENTER key.
- ▶ Press the FINISH key to complete the measurement. The line position and angle will be shown and the line feature will be added to the feature list.
- ▶ Press the CHANGE soft key to change the line fit algorithm if desired.

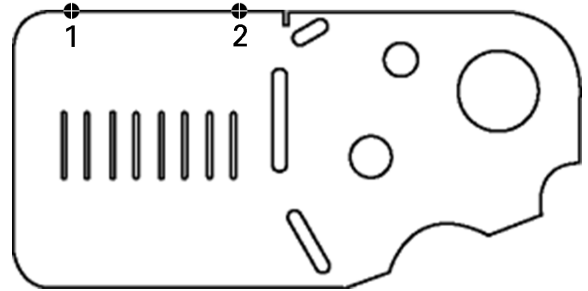

A line is probed on the part

Line fit algorithms include:

- LSBF: Fit determined by minimizing the sum of the squared point deviations from the form fit.
- ISO: Fit determined by minimizing the form deviation.

LINE 5		mm	1	+
	X	23.881		
	Y	43.515		
	Δ	0°00'		
Pts=2		F 0.000		
DRO				
Recall	View	Change	To1	

The line position and angle are shown and the line feature is added to the feature list

Measuring circles

A minimum of 3 points are required to measure a circle. A maximum of 100 points can be probed and will be processed by a fit algorithm to define the circle.



- ▶ Press the CIRCLE MEASUREMENT key. The Probe Circle screen will be displayed. Press the key twice to measure a series of circles using auto repeat.
- ▶ Move the stage to position the crosshairs over a point on the circumference of the circle and press the ENTER key.
- ▶ Move the stage to position the crosshairs over two other points evenly distributed around the circumference, pressing the ENTER key to collect each point.
- ▶ Press the FINISH key to complete the measurement. The circle position and diameter will be shown and the circle feature will be added to the feature list.



- ▶ Press the D/R AXIS soft key to toggle the display between Diameter and Radius if desired.
- ▶ Press the CHANGE soft key to change the circle fit algorithm if desired.

Circle fit algorithms include:

- LSBF: Fit determined by minimizing the sum of the squared point deviations from the form fit.
- ISO: Fit determined by minimizing the form deviation.
- Outer: Yields the biggest circle.
- Inner: Yields the smallest circle.

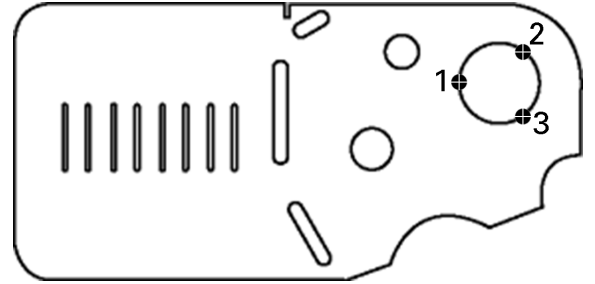

A circle is probed on the part

CIRCLE 6		mm	1	+
X	75.901			
Y	30.612			
D/r	12.498			
Pts=3		F 0.000		
DRO				
Recall	View	Change		To1

The circle position and diameter are shown and the circle feature is added to the feature list

Measuring distances

Two points are required to measure a distance.



- ▶ Press the DISTANCE MEASUREMENT key. The Probe Distance screen will be displayed. Press the key twice to measure a series of distances using auto repeat.
- ▶ Move the stage to position the crosshairs over the first of the two points, then and press the ENTER key.
- ▶ Move the stage to position the crosshairs over the second of the two points, and then and press the ENTER key.
- ▶ Press the FINISH key to complete the measurement. The X, Y and vector distances will be shown and the distance feature will be added to the feature list.
- ▶ When a Z-axis is used, press the L/Z AXIS soft key to toggle the display between the vector distance (L) and the Z height if desired. Z-axis height is not used in the calculation of vector distance.

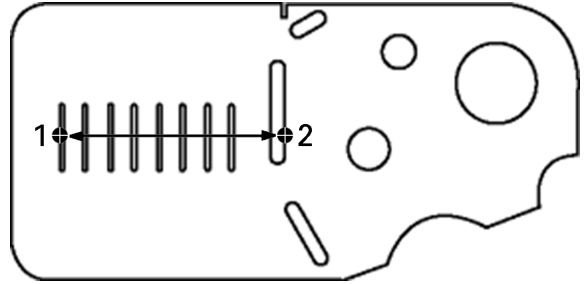

A distance is probed on the part

DISTANCE 7		mm	<u>1</u>	+	
	X	35.821			
	Y	0.332			
	L / Z	35.823			
DRO		Pts=2			
Recall	View				Tol

The X, Y and vector distances are shown and the distance feature is added to the feature list

Measuring angles

A minimum of 4 points evenly divided on two legs of an angle are required to measure an angle. A maximum of 100 points can be probed on the two angle legs. Once the minimum two points are probed on each angle leg, additional points can be distributed between the two legs in any proportion. For example, the first leg could be defined by 4 points, and the second by 8.



- ▶ Press the ANGLE MEASUREMENT key. The Probe Angle screen will be displayed. Press the key twice to measure a series of angles using auto repeat.
- ▶ Move the stage to position the crosshairs over a minimum of two points evenly distributed on one angle leg, pressing the ENTER key to collect each point.
- ▶ Press the finish key to complete the measurement of the first leg.
- ▶ Move the stage to position the crosshairs over a minimum of two points evenly distributed on the second angle leg, pressing the ENTER key to collect each point.
- ▶ Press the FINISH key to complete the angle measurement. The angle and angle vertex position will be shown. The angle feature and two angle leg features will be added to the feature list.
- ▶ Press the CHANGE soft key to change the angle type if desired.

Angle types include:

- INCLD: Included angle (A1).
- 360-A1: 360 degrees - included angle.
- 180+A1: 180 degrees + included angle.
- 180-A1: 180 degrees - included angle

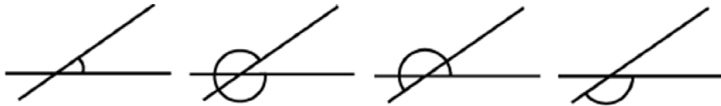

INCLD (A1)

360 - A1

180 + A1

180 - A1

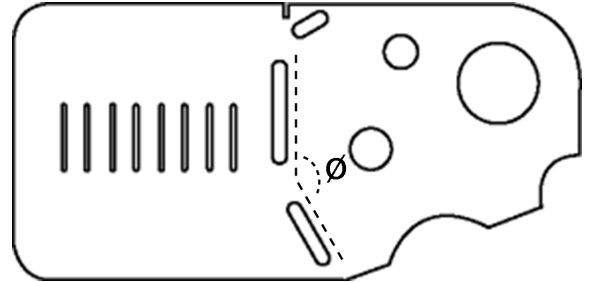

Slot features form an angle (\emptyset) on the part

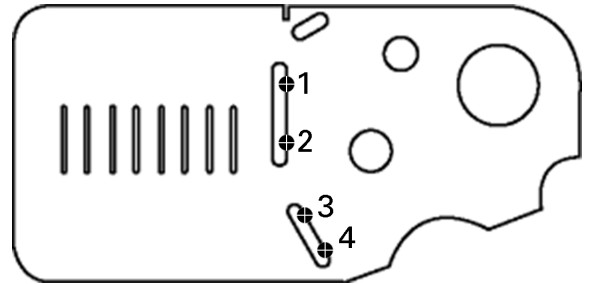

The two legs of an angle are probed on the part

ANGLE 10		mm	1	+
	X	43.450		
	Y	17.795		
	Δ	156°24'		
Fts=2				
DRO From 9,8				
Recall	View	Change	To1	

The angle and angle vertex position are shown. The angle and angle legs are added to the feature list

1.5 Creating Part Features

Created features

It can be useful to create features that are not found on the part geometry. Created features can be used as reference points for inspection purposes. For example, in order to measure a feature that is referred to a point off the part geometry, the user could create the reference point.

Users can create points, lines, circles, distances, angles, and part skews. Created features are the same as probed features except that the created features are geometrically perfect, so form error and tolerance values do not apply.

Created features are not the same as constructed features, which are discussed in the next section of this chapter. Created features are defined by the user. For example, to create a circle, the user defines the location of the center point and the diameter or radius.

Constructed features are built from previously measured or created parent features. For example, the user could construct a line between two or more points in the feature list. Constructed features can have form errors and tolerance values.

Creating features

The method of creating a feature is identical for all feature types. To create a feature:

- ▶ Press the desired feature MEASUREMENT key
- ▶ Press the CREATE soft key
- ▶ Enter the required feature data
- ▶ Press the FINISH key



An example of creating a feature is shown on the next page.

Example of creating a feature

In this example, a circle is created:



- ▶ Press the feature MEASUREMENT key. In this example, the CIRCLE MEASUREMENT key is pressed and the Probe Circle screen is displayed.
- ▶ Press the CREATE soft key to display the Create data entry screen. In this example, the Create Circle screen is displayed.
- ▶ Enter the desired feature parameters. In this example, the circle position and diameter (or radius) values are entered into the X, Y, Z and D data fields.
- ▶ Press the FINISH key. The new feature will be shown on the screen and added to the feature list.

Probe Circle		mm	1	+
Pts	X	-	1.327	
0	Y	11.958		
	Z	0.000		
	Q	0.000		
DRO				
Probe	Recall	Create	Constr	

CIRCLE MEASUREMENT key is pressed

Create Circle		mm	1	+
Position				
X	1.5			
Y	1.5			
Z	0			
Size				
D	0.75			
Radius				

Circle position and diameter values are entered

CIRCLE 6		mm	1	+
X	1.500			
Y	1.500			
D/r	0.750			
Created				
DRO				
Recall	View			Tol

New circle is shown in the feature list

1.6 Constructing Part Features

Constructed features

New features can be constructed from probed, created, or other constructed features from the features list. Constructions are frequently used to perform skew alignments, set datums and measure relationships between parent features.

Users can construct points, lines, circles, distances, angles, and part skews. Constructed features are the same as probed features. They can have form errors and tolerances can be applied.



If a construction is requested that does not include the required parent features or is not supported, an error message is displayed indicating an “Invalid construction”.

Constructing features

The method of constructing a feature is identical for all feature types. To construct a feature:

- ▶ Press the desired feature MEASUREMENT key
- ▶ Press the CONSTR soft key or the UP ARROW CURSOR key
- ▶ Highlight a required parent feature, then press the ENTER key to select it
- ▶ Continue highlighting and selecting parent features until all the required features are selected
- ▶ Press the FINISH key



An example of constructing a feature is shown on the next page.

Example of constructing a feature

In this example, a new point feature is constructed from two parent circle features:

- ▶ Press the feature MEASUREMENT key corresponding to the feature you want to construct. In this example, the POINT MEASUREMENT key is pressed.
- ▶ Press the CONSTR soft key **or** press the up ARROW CURSOR key to highlight the last feature in the feature list. If the last feature in the feature list will not be one of the parent features, press the up ARROW CURSOR key until the first parent feature is highlighted. In this example, the first parent circle feature is at the bottom of the feature list.
- ▶ Press the ENTER key to select the highlighted feature. A checkmark will appear at the feature location in the list.

Probe Point		mm	1	+
Pts	X	- 1.990		
	Y	27.238		
	Z	0.000		
	Q	0.000		
DRO				
Probe	Recall	Create	Constr	

POINT MEASUREMENT key is pressed

Construct Point		mm	1	+
X	67.495			
Y	29.513			
D/r	16.502			
Pts=7		F	3.692	
DRO				
	Recall	View	Probe	

First circle feature is highlighted

Construct Point		mm	1	+
X	67.495			
Y	29.513			
D/r	16.502			
Pts=7		F	3.692	
DRO				
	Recall	View	Probe	

First circle feature is selected as a parent feature

- ▶ Continue highlighting and then selecting features until all the required parent features are selected. In this example, the second circle feature is highlighted and selected.
- ▶ Press the FINISH key to construct the new feature. The new feature will be added to the feature list. In this example, a new point feature is shown at the bottom of the feature list.

Construct Point		mm	1	+
X	76.443			
Y	30.551			
D/r	13.332			
Pts=8		F	0.877	
DRO				
	Recall	View	Probe	

Second circle feature is highlighted

Construct Point		mm	1	+
X	76.443			
Y	30.551			
D/r	13.332			
Pts=8		F	0.877	
DRO				
	Recall	View	Probe	

Second circle feature is selected as a parent feature

POINT 10		mm	1	+
X	72.598			
Y	35.997			
Z	0.000			
Fts=2		From 9,5		
DRO				
Recall	View	Change		To1

FINISH key is pressed to create new point feature

- ▶ Press the VIEW key to show a graphic image of the feature construction. In this example the image shows that the **Int 1 point feature** was constructed at the top intersection of the two circle circumferences.
- ▶ Press the CHANGE soft key to show alternative point features that can be constructed from the two parent circle features.
- ▶ Press the desired construction alternative soft key to change the feature construction type. In this example, the **Mid Pt point feature** was selected, and the point is constructed at the mid point between the two circle center points.

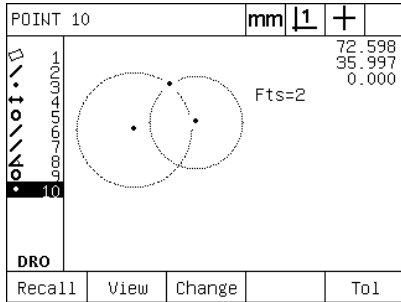

VIEW soft key is pressed to show graphic image of constructed feature

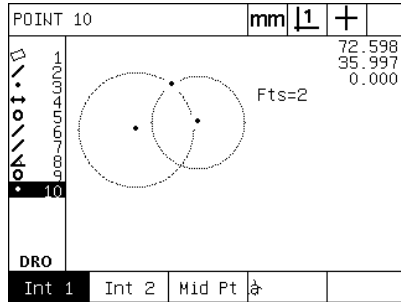

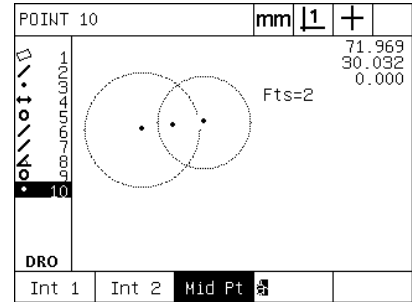

CHANGE soft key is pressed to show alternative constructions





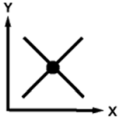

Point feature type is changed from Int 1 to Mid Pt

More feature construction examples

A collection of some typical feature constructions are shown here graphically as examples. Many more constructions are possible. Invalid construction requests will initiate an error message.

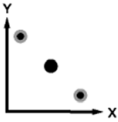
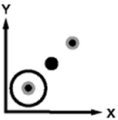
Construction	Parent features	Graphic
Point	Two lines: intersection	
Point	Line and circle: intersection	
Point	Two circles: intersection	

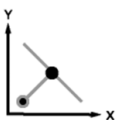
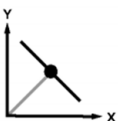
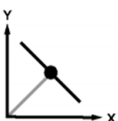
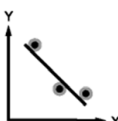
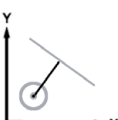
1.6 Constructing Part Features

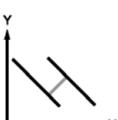
Construction	Parent features	Graphic
Point	Two points: mid point	
Point	Point and circle: mid point	
Point	Distance and point: offset	
Point	Circle: center point	
Point	Line and point: perpendicular	
Point	Line and datum: perpendicular	
Line	Points: Best fit	
Line	Line and circle: perpendicular	
Line	Two lines: bisector	
Line	Line and distance: offset	

Construction	Parent features	Graphic
Circle	Multiple circles: best fit	
Circle	Circle and distance: offset	
Distance	Two points: point to point	
Distance	Circle and circle: center to center	
Distance	Point and line: perpendicular	
Angle	Two lines: vertex	

1.7 Tolerancing

Feature tolerances

The following tolerances are available in the ND 1200.

Feature type	Tolerance
Point	Bidirectional position
Point	True position
Line	Bidirectional position
Line	True position
Line	Straightness
Line	Perpendicularity
Line	Parallelism
Line	Angle
Circle	Bidirectional position
Circle	True position
Circle	LMC: Least material condition
Circle	MMC: Maximum material condition
Circle	Roundness
Circle	Concentricity
Circle	Runout
Distance	Width
Angle	Angle

Applying tolerances

The method of applying tolerances is identical for all feature types. To apply a tolerance:

- ▶ Highlight a feature in the feature list using the ARROW CURSOR keys.
- ▶ Press the TOL soft key to display the tolerance soft keys.
- ▶ Press the soft key corresponding to the desired tolerance type, such as runout for a circle. A new screen will be displayed containing data fields for nominal and tolerance values.
- ▶ Enter the nominal and tolerance values and then press the FINISH key to display the tolerance results. Press the finish key again to return to the DRO screen.

Measurements that pass tolerance tests are indicated by a checkmark in the tol soft key box. Measurements that fail are indicated by a crossed circle in the Tol soft key box and by outlined characters in the DRO screen.

CIRCLE 4		mm	1	+
	X	76.236		
	Y	30.293		
	D/r	13.059		
DRO		Pts=4	F 0.147	
Recall	View	Change	✓ Tol	

Passed tolerance indicated by checkmark in TOL soft key box

CIRCLE 4		mm	1	+
	X	76.236		
	Y	30.293		
	D/r	13.059		
DRO		Pts=4	F 0.147	
Recall	View	Change	⊗ Tol	

Failed tolerance indicated by crossed circle in TOL soft key box and outline characters



An example of applying a tolerance is shown on the next page.

Example of applying a tolerance

In this example, a form tolerance (roundness) is applied to a circle feature:

- ▶ Use the ARROW CURSOR keys to highlight the desired feature in the feature list. In this example, the circle feature is highlighted.
- ▶ Press the TOL soft key to display the tolerance alternatives above the soft keys at the bottom of the screen. In this example, the circle tolerance alternatives are:
 - POS (Position)
 - FORM
 - RUNOUT
 - CON (Concentricity)
- ▶ Press the soft key corresponding to the desired tolerance type to display the data entry screen. In this example, the FORM soft key was pressed and the data entry screen for specifying the roundness tolerance is displayed. Initially, the tolerance data field (**Tol. Zone**) contains the measured deviation from ideal roundness.

CIRCLE 4		mm	1	+
CIRCL 4	X	76.236		
	Y	30.293		
	D/r	13.059		
	Pts=4	F 0.147		
DRO				
Recall	View	Change	Tol	

Circle feature is highlighted using ARROW CURSOR keys

CIRCLE 4		mm	1	+
CIRCL 4	X	76.236		
	Y	30.293		
	D/r	13.059		
	Pts=4	F 0.147		
DRO				
Pos	Form	Runout	Con	Hia

TOL soft key is pressed to display tolerance soft keys

CIRCLE 4		mm	1	+
Tolerance: Form				
Tol.Zone				
0.147				
None				

FORM soft key is pressed to display the tolerance data entry screen

- ▶ Enter the desired nominal and tolerance values into the data fields provided. In this example of circle form tolerance, only the roundness tolerance field is provided, and a tolerance of 0.15 is entered.
- ▶ Press the FINISH key to display the tolerance result. The tolerance and actual values will be displayed. In this example, the tolerance value was greater than the actual value and the tolerance passed. A checkmark is shown to indicate a passed test.
- ▶ Press the FINISH key again to return to the DRO screen. The checkmark is shown again in the TOL soft key box.

CIRCLE 4	mm	1	+	
Tolerance: Form				
Tol.Zone				
0.15				
None				

The form tolerance is entered

CIRCLE 4	mm	1	+	
Circle Tolerance Results				
Tol Type: Form				
Tol.Zone Actual				
0.150 0.147 ✓				
Edit				

The FINISH soft key is pressed to display the tolerance test result

CIRCLE 4	mm	1	+	
X 76.236				
Y 30.293				
D/r 13.059				
Pts=4 F 0.147				
DRO				
Recall	View	Change	✓ Tol	

The FINISH key is pressed to return to the DRO screen

1.8 Programming

ND 1200 programs

ND 1200 programs automate repetitive measurement and inspection tasks. Programs are recorded sequences of measurement and other operator key-press activities stored in the ND 1200 to be played back later when inspecting identical parts. Any key-press activity can be included. Programs save time and ensure greater consistency because all parts are measured the same way.

When program recordings are run (played back) using the graphic VIEW screen, a targeting image of part probing is displayed to assist the operator. The targeting view displays a feature graphic showing the next point to be probed and an arrow that represents the probe. As the stage is moved to position the probe over the indicated point, the arrow moves closer to the point shown on the part image.

ND 1200 programs can be:

- Recorded
- Run
- Edited
- Copied
- Deleted

Recording a program

To record a ND 1200 program:

- ▶ Press the MENU key.
- ▶ Press the PROG soft key. The Program screen will be displayed.
- ▶ Press the RECORD soft key. The program number dialog box will be displayed.
- ▶ Enter the desired program number and press the OK soft key.
- ▶ Perform the desired measurement and other activities that you wish to record.
- ▶ Press the MENU key.
- ▶ Press the PROG soft key.
- ▶ Press the END REC soft key to stop recording the program. The new program will be added to the list of programs.
- ▶ Press the FINISH key to return to the DRO screen.
- ▶ Run and test the program to verify its correctness. Edit the program if necessary.



An example of recording a program is shown on the next page.

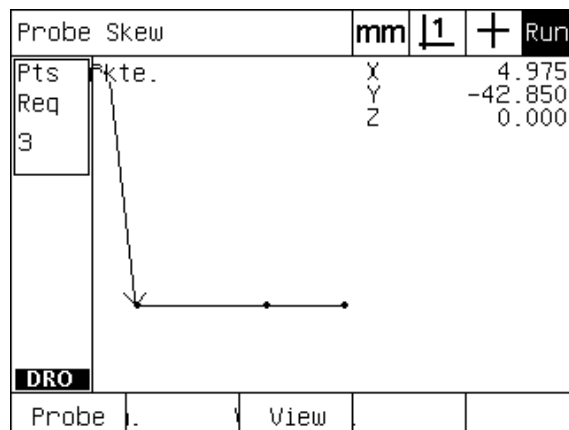

When the program is run, the VIEW soft key is pressed to display the targeting graphic

Example of recording a program

In this example, a program is created to measure several features on the 2-D demo part:

- ▶ Press the MENU soft key to display the menu soft key titles at the bottom of the screen.
- ▶ Press the PROG soft key to display the Programs screen.
- ▶ Press the RECORD soft key to initiate the recording process and display the program number dialog box.
- ▶ Enter the desired program number and press the OK soft key to begin recording your activities. The DRO screen will be displayed and a REC indication will be shown in the upper right corner of the screen.

Current Position		mm	1	+
X	0.000			
Y	0.000			
Z	0.000			
Q	0.000			
DRO				
Setup	Prog	Extra	Clear	Edge

Menu key is pressed to show menu soft key titles

Programs		mm	1	+
No programs in memory.				
Record				

PROG soft key is pressed to show Programs screen

Enter program number:

1 _____

RECORD soft key is pressed and the program number is entered

- ▶ Perform all measurement and other inspection activities as usual. Program recording will continue in the background.
- ▶ When all part inspection activities are complete, press the MENU soft key to display the menu soft key titles at the bottom of the screen.
- ▶ Press the PROG soft key to display the Programs screen.
- ▶ Press the END REC soft key to stop recording and store the program.

Current Position		mm	1	+	REC
X	0.000				
Y	0.000				
Z	0.000				
Q	0.000				
DRO					
Probe	Teach				

When recording begins, a REC indication is shown in the upper right

Current Position		mm	1	+	REC
X	8.955				
Y	44.843				
Z	0.000				
Q	0.000				
DRO					
Setup	Prog	Extra	Clear	Edge	

When inspection is complete, the menu key is pressed to show menu soft keys

Programs		mm	1	+	REC
1					
End Rec	Run	Edit	Copy	Delete	

The PROG and then END REC soft keys are pressed to stop recording and store the program

Running a program

To run (play back) a ND 1200 program:

- ▶ Press the MENU key.
- ▶ Press the PROG soft key. The Program screen will be displayed.
- ▶ Use the ARROW CURSOR keys to highlight the desired program number.
- ▶ Press the RUN soft key. The DRO screen will be displayed and the program will begin running. An indication of an active recording will be shown in the upper right corner of the screen.
- ▶ Press the VIEW soft key to show the targeting graphic screen.



Do not use the targeting graphic to perform fine positioning of the crosshair probe. The targeting graphic is only provided to assist rough positioning.

- ▶ Perform the indicated measurements and other activities prompted by the program. The program will stop running and the DRO screen will be displayed automatically when all the program steps have been completed.



An example of running a program is shown on the next page.

Example of running a program

In this example, the program recorded in the earlier example of recording a program is run:

- ▶ Press the MENU soft key to display the menu soft key titles at the bottom of the screen.
- ▶ Press the PROG soft key to display the Programs screen.
- ▶ Highlight the desired program number using the ARROW CURSOR keys.

Current Position		mm	1	+
X	0.000			
Y	0.000			
Z	0.000			
Q	0.000			
DRO				
Setup	Prog	Extra	Clear	Edge

Menu key is pressed to show menu soft key titles

Programs		mm	1	+
1				
2				
3				
DRO				
Record	Run	Edit	Copy	Delete

PROG soft key is pressed to show Programs screen

Programs		mm	1	+
1				
2				
3				
DRO				
Record	Run	Edit	Copy	Delete

The desired program is selected

- ▶ Press the RUN soft key to initiate the program play back and display the DRO screen.
- ▶ Press the view soft key to display the targeting graphic to assist rough part positioning.
- ▶ Follow the program prompting messages to perform all measurement and other inspection activities. When all the program steps have been completed, the program will stop and the DRO screen will be displayed.

Current Position		mm	1	+	REC
X	0.000				
Y	0.000				
Z	0.000				
Q	0.000				
DRO					
Probe	Teach				

The program begins running

Probe Circle		mm	1	+	Run
Pts	kte.	X	3.757		
Req		Y	-1.993		
4		Z	0.000		
DRO					
Probe	.	View			

The targeting view is used for rough part positioning

Current Position		mm	1	+
X	8.955			
Y	44.843			
Z	0.000			
Q	0.000			
DRO				
Probe	Teach			

The program steps are complete and the DRO screen is displayed

Editing a program

Programs can be edited to change, insert, or delete program steps. There are a variety of reasons to edit programs. A program may contain an error or omission. For example, a feature may have been left out or measured using the wrong reference. Part specifications might change and editing an existing program is often faster than creating a new program. Edit programs to:

- Expand or change a program step
- Delete a program step
- Insert a new program step



Use care when editing program steps, and store a backup of the program first. Deleted steps cannot be restored.

To edit a program:

- ▶ Display the steps.
- ▶ Expand a step if necessary.
- ▶ Edit the program by:
 - Changing a step
 - Deleting a step
 - Inserting a new step
- ▶ Close the edit session and save edits by pressing the FINISH key.

Displaying program steps

To display program steps:

- ▶ Press the MENU soft key to display the menu soft key titles at the bottom of the screen.
- ▶ Press the PROG soft key to display the Programs screen.
- ▶ Highlight the desired program number using the ARROW CURSOR keys.
- ▶ Press the EDIT soft key to display the list of program steps. A EDT indication will be shown in the upper right corner of the screen.

Current Position		mm	1	+
X	45.108			
Y	45.175			
Z	0.000			
Q	0.000			
DRO				
Setup	Prog	Extra	Clear	Edge

Menu key is pressed to show menu soft key titles

Programs		mm	1	+
1				
Record	Run	Edit	Copy	Delete

PROG soft key is pressed to show Programs screen

1		mm	1	+	EDT
1 Prg Properties					
2 Settings					
9 Probe Skew 1 (Pts=3)					
14 Probe Line 2 (Pts=3)					
• 19 Construct Point 3 (Fts=2)					
23 Zero X Axis Of Feat 3					
24 Targeting View On					
25 Zero Y Axis Of Feat 3					
• 26 Probe Circle 4 (Pts=4)					
32 End Prg					
Record	Run	Edit			Tol

The EDIT soft key is pressed to show the program steps

Expanding and compressing a program step

To expand or compress a program step:

- ▶ Use the ARROW CURSOR keys to highlight a compressed step. Compressed steps are indicated by a + sign in a box in front of the step.
- ▶ Press the ENTER key to toggle between expanding and compressing the step.

1	mm	<u>1</u>	+	EDT
1 Prg Properties 2+ Settings / 9 Probe Skew 1 (Pts=3) / 14 Probe Line 2 (Pts=3) • 19 Construct Point 3 (Fts=2) 23 Zero X Axis Of Feat 3 24 Targeting View On 25 Zero Y Axis Of Feat 3 • 26 Probe Circle 4 (Pts=4) 32 End Prg				
Record	Run	Edit		To1

A step is highlighted

1	mm	<u>1</u>	+	EDT
1 Prg Properties 2+ Settings 3 Targeting View Off 4 Select Datum 1 5 Probe = Crosshair 6 Units = mm 7 Mode = Cartesian 8 End Settings / 9 Probe Skew 1 (Pts=3) / 14 Probe Line 2 (Pts=3) + 19 Construct Point 3 (Fts=2)				
Record	Run	Edit		To1

The ENTER key is pressed to expand the step

1	mm	<u>1</u>	+	EDT
1 Prg Properties 2+ Settings / 9 Probe Skew 1 (Pts=3) / 14 Probe Line 2 (Pts=3) • 19 Construct Point 3 (Fts=2) 23 Zero X Axis Of Feat 3 24 Targeting View On 25 Zero Y Axis Of Feat 3 • 26 Probe Circle 4 (Pts=4) 32 End Prg				
Record	Run	Edit		To1

The ENTER key is pressed to compress the step

Changing a program step

Program steps can be edited to change:

- Program properties
- Settings
- Tolerances

To change program steps:

- ▶ Use the ARROW CURSOR keys to highlight a step. Expand the step if necessary.
- ▶ Press the ENTER key to cycle through the available alternatives and select a new value for the highlighted the step.
- ▶ Press the FINISH key to change the step.
- ▶ Press the FINISH key again to leave the edit mode and return to the programs screen.

Example of changing ND 1200 settings

In this example, ND 1200 settings will be edited to change the unit of measure from mm to inches:

To change ND 1200 settings:

- ▶ Use the ARROW CURSOR keys to highlight the Settings step.
- ▶ Press the ENTER key to expand the Settings step.
- ▶ Use the ARROW CURSOR keys to highlight the Units step.
- ▶ Press the ENTER key to change the Units step value from mm to inch.
- ▶ Press the FINISH key to save to change and return to the Programs screen.

1	mm	1	+	EDT
1	Prg Properties			
2	Settings			
3	Targeting View Off			
4	Select Datum 1			
5	Probe = Crosshair			
6	Units = mm			
7	Mode = Cartesian			
8	End Settings			
9	Probe Skew 1 (Pts=3)			
14	Probe Line 2 (Pts=3)			
19	Construct Point 3 (Fts=2)			
Record	Run	Edit		Tol

The Settings step is highlighted and expanded

1	mm	1	+	EDT
1	Prg Properties			
2	Settings			
3	Targeting View Off			
4	Select Datum 1			
5	Probe = Crosshair			
6	Units = mm			
7	Mode = Cartesian			
8	End Settings			
9	Probe Skew 1 (Pts=3)			
14	Probe Line 2 (Pts=3)			
19	Construct Point 3 (Fts=2)			
Record	Run	Edit		Tol

The Units step is highlighted

1	mm	1	+	EDT
1	Prg Properties			
2	Settings			
3	Targeting View Off			
4	Select Datum 1			
5	Probe = Crosshair			
6	Units = inch			
7	Mode = Cartesian			
8	End Settings			
9	Probe Skew 1 (Pts=3)			
14	Probe Line 2 (Pts=3)			
19	Construct Point 3 (Fts=2)			
Record	Run	Edit		Tol

The ENTER key is pressed to change from mm to inch units

Example of changing program properties

In this example, program properties will be edited to change the behavior of the program when a tolerance fails. Initially, the program pauses when a tolerance fails; after the change, the program will not pause:

To change program properties:

- ▶ Use the ARROW CURSOR keys to highlight the Prg Properties step.
- ▶ Press the ENTER key to expand the Prg Properties step.
- ▶ Use the ARROW CURSOR keys to highlight the Pause Tol Results step.
- ▶ Press the NEVER soft key and then the ENTER key to change the Pause Tol Results step value from If Fail to Never.
- ▶ Press the FINISH key to save to change and return to the Programs screen.

1	mm	1	+	EDT
1 Prg Properties				
2 Settings				
9 Probe Skew 1 (Pts=3)				
14 Probe Line 2 (Pts=3)				
• 19 Construct Point 3 (Fts=2)				
23 Zero X Axis Of Feat 3				
24 Targeting View On				
25 Zero Y Axis Of Feat 3				
o 26 Probe Circle 4 (Pts=4)				
/ 32 Probe Line 5 (Pts=2)				
▼ 33 Wait Pt (13.599,43.182)				
Record	Run	Edit		To1

The Prg Properties step is highlighted and expanded

Prg Properties	mm	1	+	EDT
Use Machine Ref	<u>Yes</u>			
Clear Features	<u>Yes</u>			
Use As Recorded	No			
Pause Tol Res	If Fail			
Print Tol Res	<u>Never</u>			
Never	If Fail	If Pass	Always	

The Pause Tol Results step is highlighted

Prg Properties	mm	1	+	EDT
Use Machine Ref	<u>Yes</u>			
Clear Features	<u>Yes</u>			
Use As Recorded	No			
Pause Tol Res	Never			
Print Tol Res	<u>Never</u>			
Never	If Fail	If Pass	Always	

The NEVER soft key and then ENTER key to change from If Fail to Never

Example of changing tolerances

In this example, a roundness form tolerance will be edited to be more forgiving:

To change a tolerance:

- ▶ Use the ARROW CURSOR keys to highlight the Circle measurement step.
- ▶ Press the TOL key to display the circle tolerance screen.
- ▶ Highlight the desired data field if necessary. In this example, the Tol. Zone field is already highlighted.
- ▶ Enter the new tolerance value.
- ▶ Press the FINISH key to save to change and return to the Programs screen.

1	mm	1	+	EDT
1 Prg Properties				
2 Settings				
9 Probe Skew 1 (Pts=3)				
14 Probe Line 2 (Pts=3)				
19 Construct Point 3 (Fts=2)				
23 Zero X Axis Of Feat 3				
24 Targeting View On				
25 Probe Distance 4 (Pts=2)				
29 Probe Circle 5 (Pts=4) Form				
35 Probe Line 6 (Pts=3)				
40 Probe Line 7 (Pts=3)				
Record	Run	Edit		Tol

The Circle measurement step is highlighted

CIRCLE 5	mm	1	+	EDT
Tolerance: Form				
Tol.Zone				
0.013				
None				

The Tol Zone field is highlighted

CIRCLE 5	mm	1	+	EDT
Tolerance: Form				
Tol.Zone				
0.250				
None				

The new tolerance value is entered

Deleting a program step

Program steps can be deleted to simplify programs or to remove unwanted steps. Any program step can be deleted, including program property and ND 1200 settings steps.



Use care when deleting program steps, and store a backup of the program first. Deleted steps cannot be restored.

To delete a step:

- ▶ Use the ARROW CURSOR keys to highlight the desired step.
- ▶ Press the CANCEL key.

Example of deleting a step

In this example, a probing step will be deleted from a circle measurement:

To delete the step:

- ▶ Use the ARROW CURSOR keys to highlight the Circle measurement step.
- ▶ Use the ARROW CURSOR keys to highlight a probing step.
- ▶ Press the CANCEL key to delete the step.
- ▶ Press the FINISH key to save to change and return to the Programs screen.

1	mm	1	+	EDT
24 Targeting View On				
o 25 Probe Circle 4 (Pts=4)				
26 Wait Pt (71.642,35.210)				
27 Wait Pt (81.925,34.546)				
28 Wait Pt (80.929,25.245)				
29 Wait Pt (72.969,25.245)				
30 Finish Measurement				
↔ 31 Probe Distance 5 (Pts=2)				
/ 35 Probe Line 6 (Pts=3)				
/ 40 Probe Line 7 (Pts=3)				
← 45 Construct Angle 8 (Fts=2)				
Record	Run	Edit		Tol

The circle measurement is highlighted

1	mm	1	+	EDT
24 Targeting View On				
o 25 Probe Circle 4 (Pts=4)				
26 Wait Pt (71.642,35.210)				
27 Wait Pt (81.925,34.546)				
28 Wait Pt (80.929,25.245)				
29 Wait Pt (72.969,25.245)				
30 Finish Measurement				
↔ 31 Probe Distance 5 (Pts=2)				
/ 35 Probe Line 6 (Pts=3)				
/ 40 Probe Line 7 (Pts=3)				
← 45 Construct Angle 8 (Fts=2)				
Record	Run	Edit		Tol

The probing step is highlighted within the circle measurement

1	mm	1	+	EDT
24 Targeting View On				
o 25 Probe Circle 4 (Pts=4)				
26 Wait Pt (71.642,35.210)				
27 Wait Pt (81.925,34.546)				
28 Wait Pt (80.929,25.245)				
29 Finish Measurement				
↔ 30 Probe Distance 5 (Pts=2)				
/ 34 Probe Line 6 (Pts=3)				
/ 39 Probe Line 7 (Pts=3)				
△ 44 Construct Angle 8 (Fts=2)				
48 End Prg				
Record	Run	Edit		Tol

The CANCEL key is pressed and the probing step is deleted

Inserting new program steps

Program steps can be inserted to update programs to accommodate part changes or to correct omissions.

To insert new steps:

- ▶ Use the ARROW CURSOR keys to highlight the desired insertion point for the new steps. The new steps will be inserted before, not after, the insertion point.
- ▶ Press the RECORD key. The DRO screen will be displayed in the program record mode.
- ▶ Perform the desired measurement and other activities that you wish to record as new steps.
- ▶ Press the MENU key.
- ▶ Press the PROG soft key.
- ▶ Press the END REC soft key to stop recording the program steps. The new steps will be added to the list of programs.

Example of inserting new program steps

In this example, a line measurement will be inserted at the end of the program.

To insert the steps:

- ▶ Use the ARROW CURSOR keys to position the insertion point at the end of the program.
- ▶ Press the RECORD key to display the DRO screen in the record mode.
- ▶ Perform the new measurement and press the FINISH key. In this example a line is measured.
- ▶ Press MENU key/PROG soft key/END REC soft key to return to the program list. The new measure line step will be shown.
- ▶ Press the finish key to save the program and return to the Programs screen.

1	mm	1	+	EDT
1 Prg Properties				
2 Settings				
/ 9 Probe Skew 1 (Pts=3)				
/ 14 Probe Line 2 (Pts=3)				
• 19 Construct Point 3 (Fts=2)				
23 Zero X Axis Of Feat 3				
24 Targeting View On				
25 Zero Y Axis Of Feat 3				
o 26 Probe Circle 4 (Pts=4)				
32 End Prg				
Record	Run	Edit		To1

The insertion point is highlighted

LINE 5	mm	1	+	REC
X	42.455			
Y	42.850			
Δ	179°20'			
Pts=2	F 0.000			
DRO				
Recall	View	Change		To1

The new program steps are recorded

1	mm	1	+	EDT
1 Prg Properties				
2 Settings				
/ 9 Probe Skew 1 (Pts=3)				
/ 14 Probe Line 2 (Pts=3)				
• 19 Construct Point 3 (Fts=2)				
23 Zero X Axis Of Feat 3				
24 Targeting View On				
25 Zero Y Axis Of Feat 3				
o 26 Probe Circle 4 (Pts=4)				
/ 32 Probe Line 5 (Pts=2)				
36 End Prg				
Record	Run	Edit		To1

The new steps are inserted

Copying a program

When similar parts will be measured, it is often quicker to copy an existing program and edit it to accommodate the new part than to record a new program from the beginning.

To copy a program:

- ▶ Press the MENU soft key to display the menu soft key titles at the bottom of the screen.
- ▶ Press the PROG soft key to display the Programs screen.
- ▶ Highlight the desired program number using the ARROW CURSOR keys.
- ▶ Press the COPY soft key.
- ▶ Enter the new program number and press the OK soft key.

The new copy of the original program can now be edited to accommodate the new part measurement requirements.

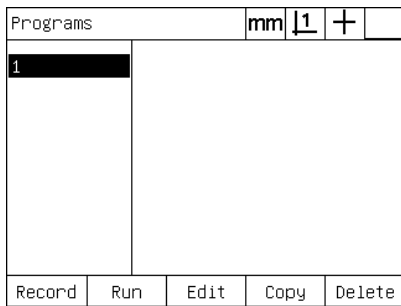

The insertion point is highlighted

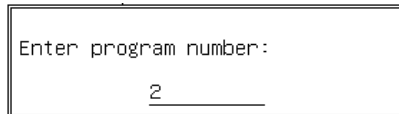

The COPY soft key is pressed and the new program number is entered

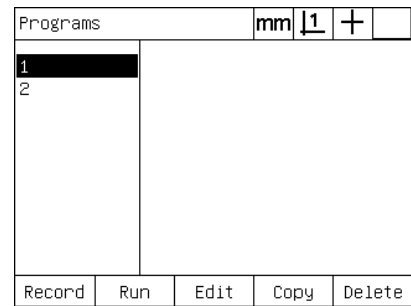

The new copy of the original program is shown in the program list

Deleting a program

When programs are no longer needed, they can be deleted to conserve resources.

To delete a program:

- ▶ Press the MENU soft key to display the menu soft key titles at the bottom of the screen.
- ▶ Press the PROG soft key to display the Programs screen.
- ▶ Highlight the desired program number using the ARROW CURSOR keys.
- ▶ Press the DELETE soft key to delete the program.



Use care when deleting programs, and store a backup of the program first. Deleted programs cannot be restored.

Programs		mm	1	+	
1					
2					
3					
4					
Record	Run	Edit	Copy	Delete	

The programs are displayed on the Programs screen

Programs		mm	1	+	
1					
2					
3					
4					
Record	Run	Edit	Copy	Delete	

The program to be deleted is highlighted

Programs		mm	1	+	
1					
3					
4					
Record	Run	Edit	Copy	Delete	

The DELETE soft key is pressed and the program is deleted

Backing up programs

Programs can be backed up prior to editing or deleting them by saving them with the ND 1200 settings file.



Backup and restore procedures should only be performed by supervisors and other technically qualified personnel. Program files are included with ND 1200 settings files. Settings files often include error correction calibration data and care must be taken to avoid using obsolete or outdated files. More details regarding saving and loading settings files are provided in Chapter 2: Installation and Specifications.

To backup a program and ND 1200 settings files:

- ▶ Plug an empty USB flash drive into the USB port.
- ▶ Press the MENU soft key to display the menu soft key titles at the bottom of the screen.
- ▶ Press the SETUP soft key to display the Setup screen menu.
- ▶ Use the ARROW CURSOR keys to highlight the Supervisor screen and then highlight the Password field.
- ▶ Enter the supervisor password.
- ▶ Press the SAVE soft key to backup the program and ND 1200 settings files on the USB flash drive.

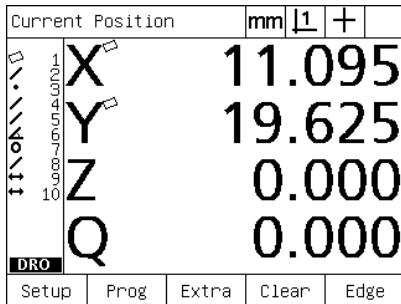

The MENU key is pressed to show soft key titles

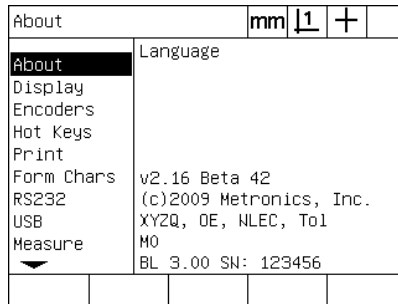

The SETUP soft key is pressed and the setup menu is displayed

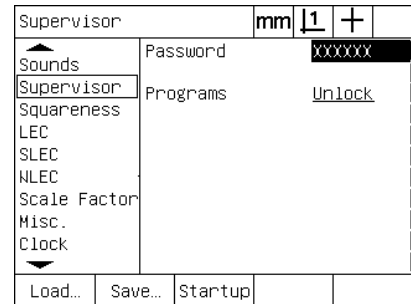

The password is entered and the program and ND 1200 settings can be saved

1.9 Reporting

Reporting

Reports of measurement results can be sent to a USB printer or USB flash drive over the USB port, or to a PC over the RS-232 serial port.



Report content, destination and format are specified in the Print, RS-232 and USB setup screens discussed in Chapter 2: Installation and Specifications.

Report types include:

Report type	Report content
Display	The data displayed on the DRO screen is sent as one row for each axis.
Report	All feature measurement data is sent in tabular form without tolerance data.
Tol Rpt	All tolerance data is sent in tabular form. Feature measurement data are not sent.
CSV	All feature measurement data is sent in as comma separated variables without tolerance data.
Tab	All feature measurement data is sent in as tab separated variables without tolerance data.
None	No data are sent.

Sending reports

Reports can be sent at any time. To send a report:



- ▶ Press the feature SEND key.

Reports can also be sent:

- By including the send function in a program
- When the Print setup screen is configured to send when an edge is recognized
- When the Measure setup screen is configured to send in response to tolerance test results
- By pressing a hot key configured in the Hot Keys setup screen to send

1.10 Error Indications

Scale errors

Only input encoder scale errors are reported by the ND 1200. Scale errors are indicated by the presence of graphic bars across the DRO screen instead of numbers. Scale errors can be caused by a few conditions shown in this table:

Possible cause	Corrective action
Damaged encoder reader head	Repair or replace the encoder.
Misaligned encoder reader head	Recalibrate the reader head.
Electrical noise on the encoder input	<p>Verify that the earth ground provided by the ND 1200 power source is in good condition and is connected to the power system ground.</p> <p>Verify that the encoder cable is shielded and that the shield is connected to ground at the ND 1200 end.</p> <p>Verify that the reader head is not generating electrical noise.</p>
Stage (encoder) velocity too high	Restrict stage velocity. If the velocity required for error-free operation is slow, recalibrate the reader head.
Faulty encoder input connection	Repair or replace the encoder cable or seek the assistance of your Metronics distributor.

1.10 Error Indications

2

**Installation, Setup and
Specifications**

2.1 ND 1200 Shipment Contents

The contents of your ND 1200 shipment are described below. Repackaging instructions are also included for return shipments for distributors and OEM customers that are configuring a ND 1200 and shipping it to an end-user.



Save the ND 1200 packaging materials for possible return shipment or shipment to an end-user.

Items included with the ND 1200

The following items are shipped with the ND 1200:

- ND 1200 instrument
- Mounting stand hardware
- Power cord
- 2-D demo part
- ND 1200 Quick reference guide
- Warranty registration card

Optional items possibly included

The following items might be shipped with your ND 1200, depending on the options and accessories ordered at the time of purchase:

- Remote foot switch
- Remote keypad
- Optical edge detector cables and cable holder
- ND 1200 Protective cover
- QC-Wedge communication software



If any components were damaged in shipment, save the packaging materials for inspection and contact your shipping agent for mediation. Contact your Metronics distributor or OEM for replacement parts.

Repackaging the ND 1200

When shipping the ND 1200 on to an end-user, repackage all ND 1200 components in the original packaging as received from the factory.



The original packaging must be duplicated and the LCD must be inserted face-up to prevent damage to the screen.



It is not necessary to ship the mounting stand and hardware with the instrument when returning the ND 1200 for service.

- Connect the mounting screws and washer to the ND 1200 instrument.
- Replace the contents of the cardboard box insert if shipping the ND 1200 on to an end-user. The cardboard box can be empty if returning the ND 1200 to the factory for service.
- Repackage the instrument, foam and cardboard box insert as originally shipped from the factory. The instrument should be oriented face-up in the carton.
- Replace the warranty card and slip sheets originally found at the top of the carton when shipping on to an end-user. The “Before you begin” slip sheet should be inserted last.

2.2 Hardware Installation

The ND 1200 is easy to install in a variety of measurement applications. This section describes how to install the ND 1200 hardware.

Assembling the mounting stand

The ND 1200 is secured to the swivel slots of the mounting stand by a shoulder screw, a cap screw and associated washers.

Assemble the ND 1200 to the mounting stand as shown, and then tighten the cap screw (5) and washers (3 & 4) so that the ND 1200 will be secure when adjusted to the desired tilt position.

- ▶ Tighten the shoulder screw (1).
- ▶ Tighten the cap screw (5) and washers (3 & 4) so that the ND 1200 will be secure when adjusted to the desired tilt position.
- ▶ Adjust the ND 1200 to the desired tilt position.

Benchtop location and mounting

Rest the ND 1200 on a flat, stable surface, or bolt it to a stable surface from the bottom using four 10/32 screws fastened in the pattern shown at the right.

The dimensions are shown in millimeters.

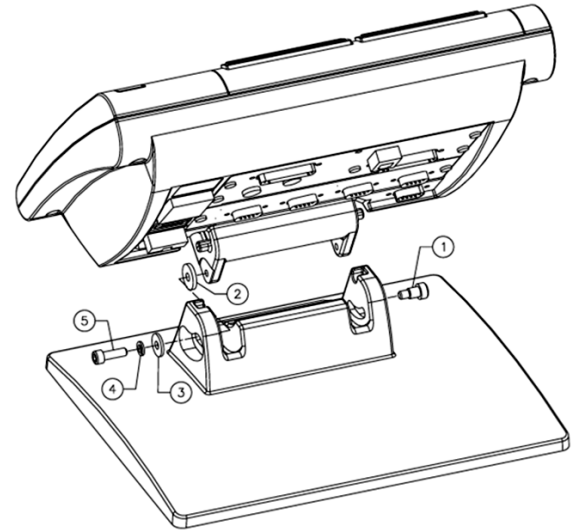

Mounting stand assembly

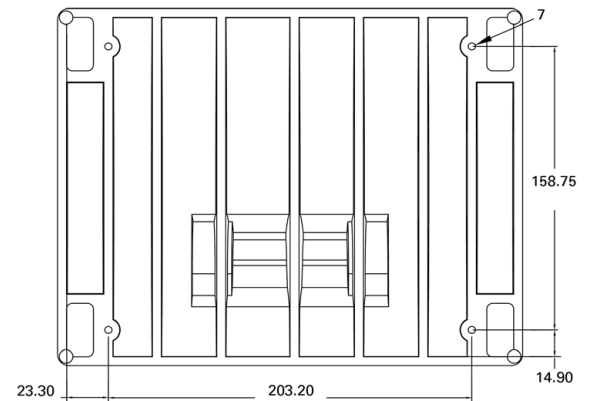

Mounting hole pattern

Arm mounting (optional)

Secure the arm mount adapter to the ND 1200 and bolt the adapter and ND 1200 to the arm as shown at the right.

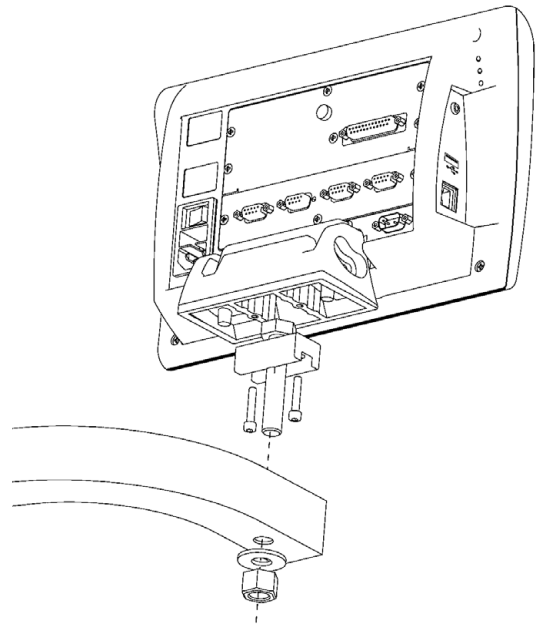

Optional arm mounting

Connecting power

Connect the ND 1200 to power through a high-quality power surge suppressor. Surge suppressors limit the amplitude of potentially damaging power line transients caused by electrical machinery or lightning, and protect the ND 1200 from most power line transients that can corrupt system memory or damage circuits.

Do not locate the power cord where it can be walked on or will create a tripping hazard. Connect the 3-wire power plug to only a 3-wire grounded power outlet.



Never connect 2-wire to 3-wire adapters to the power cord or remove the third ground wire to fit the plug into a 2-wire electrical outlet. Modifying or overriding the third-wire ground creates a safety hazard and should not be permitted.

The power connector assembly includes:

- 1 Power switch
- 2 Fuse compartment
- 3 Power cord connector



Always disconnect the power cord from the source of AC power before unplugging it from the ND 1200 power connector. The AC voltage available at electrical outlets is extremely dangerous and can cause serious injury or death.



Power switch, fuse and connector

Connecting encoders

Axis encoders are attached to interface connectors on the rear of the ND 1200. Many encoder interfaces are available to match the wide variety of encoders that can be used with the ND 1200. The type and number of axis encoder connectors will vary depending on the application. The ND 1200 shown in this photo includes connectors for the X, Y and Q axes. Encoder inputs are specified as analog or TTL at the time of purchase and cannot be changed in the field.



Do not locate encoder cables where they can be walked on or will create a tripping hazard.

The encoder connector locations are:

- 1 X-axis
- 2 Y-axis
- 3 Z/Q-axis

To connect the encoder cables:

- ▶ Verify that the ND 1200 is off.
- ▶ Connect the axis encoders tightly to their connectors. An axis label is provided near each connector. If the connectors include mounting screws, do not overtighten them.



Encoder axis connectors

Connecting a computer

Measurement result data can be sent to a computer over the RS-232 port (3) using a serial cable that does not include crossed wires. To connect a computer:

- ▶ Verify that the ND 1200 and the computer power are off.
- ▶ Connect a computer COM port to the ND 1200 RS-232 serial port (3) using a standard straight-through serial cable (Metronics part number 11B12176). Make sure the cable connectors are tight, but do not overtighten the connector screws.
- ▶ Apply power to the computer, and then the ND 1200. The ND 1200 default settings for communication over the RS-232 serial port (3) are:

Baud rate	115,200
Word length	8 bits
Stop bits	1 bit
Parity	None

- ▶ Launch the computer application that will be used to communicate with the ND 1200, and configure the communication properties of the COM port to match those of the ND 1200.



Headphone, USB and RS-232 connectors

Connecting a headphone

Audio alerts can be sent to headphones in areas that are noisy and make it difficult to hear, or are quiet where audio alerts might create a disturbance.

The speaker jack (1) is located on the side of the ND 1200.

To connect headphones:

- ▶ Verify that the ND 1200 power is off. Plug the headphones into the speaker jack (1) on the side of the enclosure.
- ▶ Make sure the headphone plug is fully inserted.

Connecting a USB printer

The ND 1200 supports certain USB printers. Printer models are specified by Metronics at the time of purchase, or approved by Metronics later.

The USB port (2) is located on the side of the ND 1200.

To connect the USB printer:

- ▶ Verify that the ND 1200 and printer power are off. Connect the USB printer to the USB Type A port (2) on the side of the enclosure.
- ▶ Make sure the USB cable plug is fully inserted.

Connecting an optional foot switch or remote keypad

The optional foot switch and remote keypad are connected to the RJ-45 connector on the side of the ND 1200.

Often, only the optional foot switch or remote keypad is used. However, two options can be connected simultaneously using a RJ-45 splitter.

The RJ-45 connector and splitter are shown here:

- 1 RJ-45 connector
- 2 RJ-45 splitter



RJ-45 splitters are available from most retail electronics stores.

The foot switch and remote keypad can be used individually or in combination:

- foot switch
- foot switch and remote keypad

When the foot switch and remote keypad are connected using the RJ-45 splitter, all operating functions of each device are retained. However, the switch shares Hot Key mapping with the number keys 7 and 8 of the remote keypad. As a result, functions assigned to the two switch contacts will also be mapped to remote keypad numbers 7 and 8.



Hot keys are discussed later in this chapter under Software setup/Hotkeys. See "Hot key assignments" on page 118.

To connect the foot switch or remote keypad:

- ▶ Verify that the ND 1200 is off.
- ▶ Plug an RJ-45 splitter into the ND 1200 RJ-45 connector if multiple devices will be used.
- ▶ Connect the RJ-45 plug of the devices into the RJ-45 splitter if multiple devices will be used, or directly into the ND 1200 RJ-45 connector if only a single device will be used.



RJ-45 connector and RJ-45 splitter



Optional foot switch and remote keypad

Connecting and installing optical edge detection

The optical edge detection option reference and sensor cables are connected to two cable jacks on the rear of the ND 1200.

The optical cable jacks are shown here:

- 1 Reference cable input
- 2 Sensor cable input

The reference cable is connected to the light reference source. The sensor cable mounts over the comparator screen and detects light-to-dark transitions. To connect the cables:

- ▶ Verify that the ND 1200 and comparator are off.
- ▶ Connect the reference and sensor cables to the ND 1200.
- ▶ Point the comparator end of the reference cable end directly at the comparator lamp. Consult the comparator manufacturer's information for specific mounting instructions.



Avoid mounting fiber-optic cables very near the lamp. High temperatures degrade fiber-optic cable performance. Install the cable to receive cooling air from the lamp fan if possible.

- ▶ Connect the sensor cable to the comparator. When the sensor will be located in front of the screen, secure the end of the sensor cable to the comparator screen using the plexiglas cable holder provided. Place the cable holder under the comparator's chart clips so the small hole in the center of the holder is positioned over an illuminated portion of the comparator screen, and then insert the metal tip of the sensor cable through the hole and flush against the screen.



Be careful not to scratch the screen with the metal tip.



Software installation of the optical edge detector is explained later in this chapter. See "Optical edge detection setup" on page 96.



Reference and sensor cable inputs



Reference and sensor cable inputs



Plexiglas optical sensor cable holder

2.3 Software setup

The operating parameters of the ND 1200 must be configured prior to using it for the first time, and any time part measurement, reporting or communication requirements change. Day to day use of the ND 1200 does not require reconfiguration of software settings.



Parameter changes made in any of the setup screens can change the operation of the ND 1200. For this reason, setup parameters are password-protected. Only qualified personnel should be given password access to setup screens. The unlocking of password-protected setup functions is described on page 90.

Software can be configured manually using the setup menu screens, or automatically by loading a settings file saved after a previous setup session. Settings files are loaded from USB drives

Parameters configured in setup screens will be retained until:

- The data-backup battery is changed
- The data and settings are cleared by maintenance personnel
- Parameters are changed using the setup menu screens
- Certain software upgrades are performed
- Previously saved settings files are loaded

Setup menu

Most operating parameters of the ND 1200 are configured using screens and data fields accessed from the setup menu. Highlighting setup menu items on the left side of the setup screen displays the corresponding setup parameter data fields and choice fields on the right side of the screen.

- 1 Setup menu item: Setup screen name
- 2 Setup data field: Setup data are entered
- 3 Setup choice field: Setup choices are made

The setup menu is easy to use:

- ▶ Press the MENU key and then press the SETUP soft key.
- ▶ Navigate up or down in the menu to highlight the desired menu item using the up/down arrow cursor keys.
- ▶ Navigate from the menu (left side) to the setup fields (right side) using the left/right ARROW CURSOR keys.
- ▶ Navigate up or down to highlight the desired data or choice field using the up/down ARROW CURSOR keys.
- ▶ Enter setup data using the NUMERIC KEYPAD, or choose a setup parameter choice from soft key selections or list. shown when the field is highlighted.
- ▶ Press the FINISH key to save the entry and return to the setup menu.
- ▶ Press the FINISH key again to return to the DRO.

An example of using the setup menu to enter the supervisor password is shown on the next page.

Encoders		mm	1	+
About	Axis	X		
Display				
Encoders				0.3308490000
Hot Keys				
Print	Type			ITL
Form Chars	Ref Marks			Ref
RS232	M.Z. Cnts			0
USB	Reversed			No
Measure				
	Units			MM

Setup screen menu items, data fields and choice fields

Setup example: entering the supervisor password

Critical setup parameters are password-protected. Only qualified personnel should be given password access to setup screen parameters. In this example, the setup menu is navigated to the Supervisor screen and the supervisor password is entered.

To enter the supervisor password:

- ▶ Press the MENU key to display the menu soft keys.
- ▶ Press the SETUP soft key to display the setup menu.
- ▶ Navigate up or down in the menu to highlight the Supervisor menu item using the ARROW CURSOR keys.

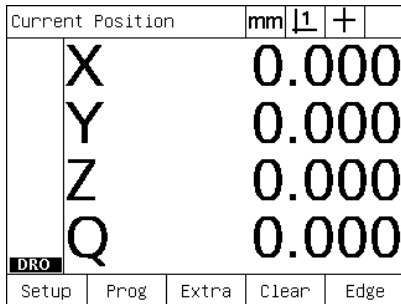

The MENU key pressed to display the menu soft keys

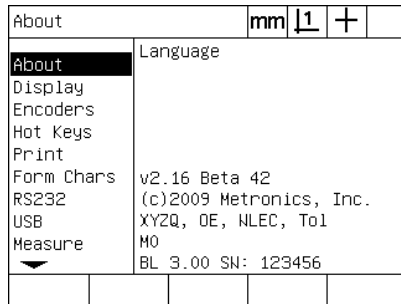

The SETUP soft key is pressed to display the setup menu

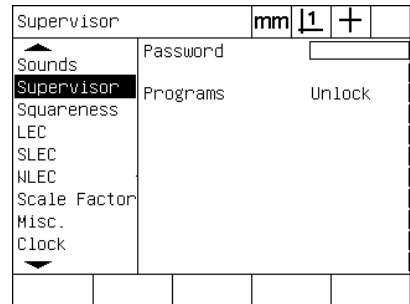

The ARROW CURSOR keys are used to highlight the Supervisor menu item

- ▶ Navigate from the menu to the Password setup field using the right ARROW CURSOR key.
- ▶ Enter the supervisor password using the NUMERIC KEYPAD.

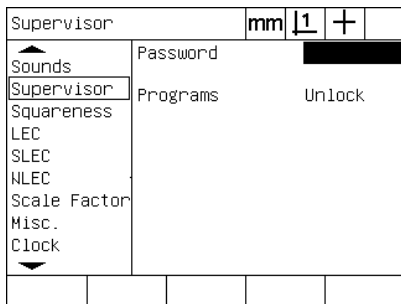

The right ARROW CURSOR key is used to highlight the Password data field

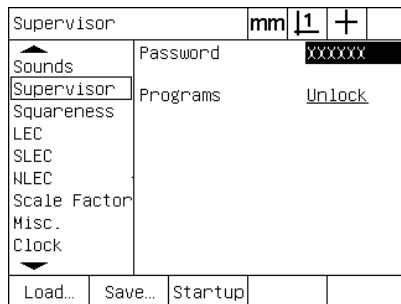

The supervisor password is entered using the NUMERIC KEYPAD

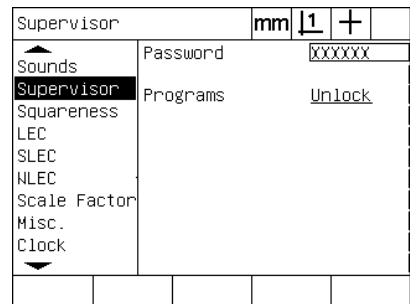

The FINISH key is pressed to save the password and return to the setup menu

- ▶ Press the FINISH key to save the password and return to the setup menu.
- ▶ Press the FINISH key to return to the DRO.

Order of setup

The ND 1200 setup software is contained on up to 18 screens, depending on the hardware configuration. It is possible that not all the setup screens described in this chapter are active in your system. Disregard screen descriptions that do not apply to your ND 1200.

The initial ND 1200 setup tasks should be performed in the order listed here. Instructions are presented in this order on subsequent pages.

Initial setup tasks	Setup screens
1: Language selection and product version information	About
2: Supervisor password entry and program unlocking	Supervisor
3: Encoder configuration	Encoders and Misc
4. Loading settings files and startup screens (instead of manual setup)	Supervisor
5: Optical edge detection setup (optional)	Misc screen and Edge soft key menu
6: Stage squareness calibration	Squareness
7: Error correction	LEC, SLEC or NLEC screen
8: Measurement scaling for parts that expand or shrink	Scale factor
9: Measurement configuration	Measure
10: Display formatting	Display

The additional setup tasks can be performed in any order.

Remaining setup tasks	Setup screens
Hot key assignments	Hot keys
Print formatting	Print and Form characters screens
RS-232 Port configuration	RS-232
USB port configuration	USB
Audio configuration	Sounds
Key repeat delay	Misc
Time and date	Clock

ND 1200 setup configurations can be saved on USB drives

Saving settings	Setup screens
Saving settings files and ND 1200 programs	Supervisor

Language selection and product version

The About screen contains selections for changing the language of text displayed on the screen, included in transmitted data and printed on reports. Product software and hardware information is also provided on the About screen.



The product software and hardware version information will be required if technical support is required.

To select a language:

- ▶ Press MENU/SETUP to display the setup menu and highlight the About menu item.
- ▶ Highlight the Language choice field.
- ▶ Press the LIST soft key to display the list of languages.
- ▶ Highlight the desired language and press the ENTER key.

About	mm	1	+
About	Language		
Display			
Encoders			
Hot Keys			
Print			
Form Chars	v2.16 Beta 42		
RS232	(c)2009 Metronics, Inc.		
USB	XY2Q, OE, NLEC, Tol		
Measure	M0		
	BL 3.00 SN: 123456		

Highlight the About menu item

About	mm	1	+
About	Language		
Display			
Encoders			
Hot Keys			
Print			
Form Chars	v2.16 Beta 42		
RS232	(c)2009 Metronics, Inc.		
USB	XY2Q, OE, NLEC, Tol		
Measure	M0		
	BL 3.00 SN: 123456		
List			

Highlight the Language choice field

English
Français
Deutsch
Italiano
Español
Português
繁體中文
日本語
Česky

Highlight a language and press the ENTER key

- ▶ Press the FINISH key to save the language and return to the setup menu.

Supervisor password and program unlocking

The Supervisor screen contains the Password data field and Programs Locking choice field.

Most setup parameters are password-protected and setup can only be performed after the password is entered. To enter the supervisor password:

- ▶ Press MENU/SETUP to display the setup menu and then highlight the Supervisor menu item.
- ▶ Highlight the Password data field.
- ▶ Enter the supervisor password.

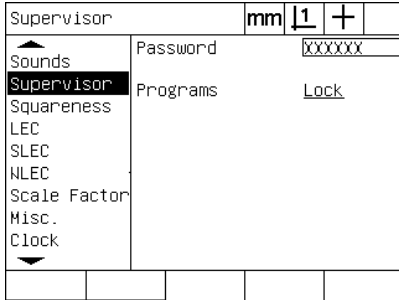

Highlight the Supervisor menu item

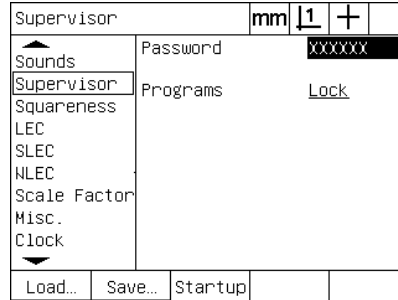

Highlight the Password data field

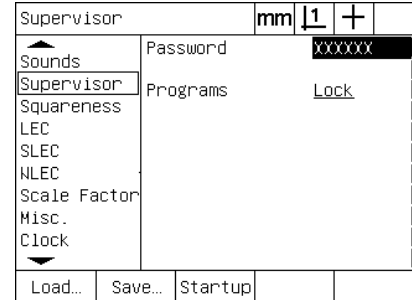

Enter the password

Program edit, copy and delete functions are locked by default. To unlock program functions:

- ▶ Highlight the Programs choice field.
- ▶ Press the UNLOCK soft key.

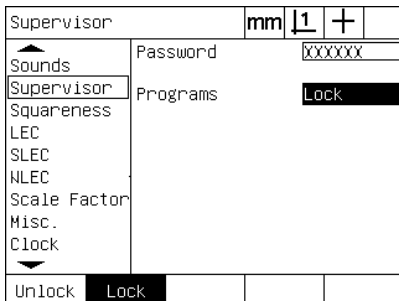

Highlight the Programs choice field

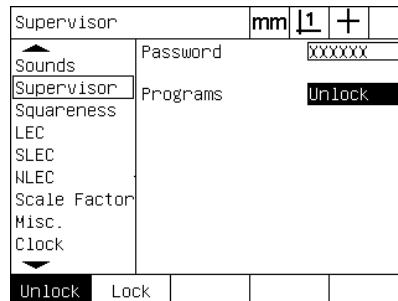

Press the UNLOCK soft key to make program editing available

- ▶ Press the FINISH key to save parameters and return to the setup menu.

Loading settings files and startup screens

The Supervisor screen contains tools for loading ND 1200 configuration settings files and OEM startup screens. Settings files can be loaded from a USB drive when the configuration parameters from a previous setup session were saved. This eliminates the need to configure the ND 1200 manually using the setup screens. Settings files also contain any ND 1200 programs and error correction data that existed when the settings file was saved. Startup screen images can also be loaded from the USB drive that display OEM graphics when the ND 1200 power is turned on.

To load settings files and startup screens:

- ▶ Insert a USB drive containing the settings.bin file and startup.txt file (optional) into the USB port.
- ▶ Press MENU/SETUP to display the setup menu and then highlight the Supervisor menu item.
- ▶ Highlight the Password data field and enter the password.
- ▶ To load the configuration parameters (settings.bin file): press the LOAD soft key, then follow the instructions displayed on the screen.
- ▶ To load the new OEM startup screen (startup.txt file): press the STARTUP soft key, then follow the instructions displayed on the screen.

Supervisor	mm	1	+
▲	Password	XXXXXX	
Supervisor	Programs	Lock	
Squareness			
LEC			
SLEC			
NLEC			
Scale Factor			
Misc.			
▼			
▼			
Load...	Save...	Startup	

Enter the Supervisor password

- ▶ Press the FINISH key to save parameters and return to the setup menu.

Encoder configuration

The Encoders and Misc screens contain data and choice fields for configuring the encoders.

Encoders screen

The Encoders screen configuration fields include:

- Axis selection
- Encoder resolution
- Encoder type TTL or analog)
- Reference mark selection
- Machine zero offset (MZ Cnts)
- Reversing encoder count direction
- Units of measure

To configure encoder settings in the Encoders screen:

- ▶ Press MENU/SETUP to display the setup menu and then highlight the Encoders menu item.
- ▶ Highlight the Axis choice field and then press a soft key to select the desired axis.



The setup process for all axes is identical.

- ▶ Highlight the Res data field and then enter the encoder resolution in the units shown in the Units choice field.

Encoders		mm	1	+
About	Axis	X		
Display	Res	0.1300000000		
Encoders				
Hot Keys				
Print	Type	TTL		
Form Chars	Ref Marks	None		
RS232	M.Z. Cnts	0		
USB	Reversed	No		
Measure	Units	MM		

Encoders menu item is highlighted

Encoders		mm	1	+
About	Axis	X		
Display	Res	0.1300000000		
Encoders				
Hot Keys				
Print	Type	TTL		
Form Chars	Ref Marks	None		
RS232	M.Z. Cnts	0		
USB	Reversed	No		
Measure	Units	MM		
X	Y	Z	Q	

Press an axis soft key

Encoders		mm	1	+
About	Axis	X		
Display	Res	0.1300000000		
Encoders				
Hot Keys				
Print	Type	TTL		
Form Chars	Ref Marks	None		
RS232	M.Z. Cnts	0		
USB	Reversed	No		
Measure	Units	MM		

Enter the encoder resolution

- ▶ Highlight the Type choice field and then press a soft key to select the encoder type.
- ▶ Highlight the Ref Marks choice field and then press the LIST soft key to display the reference mark choices. Highlight the required encoder reference mark type and press the ENTER key.

 Reference marks must be used if SLEC or NLEC error correction will be performed later. Error correction is discussed later in this chapter.

The M.Z. Cnts (Machine zero counts) data field is rarely used to specify an offset from the machine zero position created by crossing encoder reference marks.

Custom machine zeroes are rarely used because datums are always established before performing measurements.

- ▶ To specify a custom machine zero, highlight the M.Z. Cnts data field and enter the machine zero offset in machine counts as determined by: $\text{Machine counts} = \text{DRO value} / \text{encoder resolution}$.

Encoders		mm	1	+
About	Axis	X		
Display	Res	0.1300000000		
Encoders	Type	TTL		
Hot Keys	Ref Marks	None		
Print	M.Z. Cnts	0		
Form Chars	Reversed	No		
RS232	Units	MM		
USB				
Measure				
TTL	Analog	MTISer	MTI 2	

Select the encoder type

None
Ref
Abs AC
Abs HH
Manual
MS20

Select an encoder reference mark type from the list

Encoders		mm	1	+
About	Axis	X		
Display	Res	0.1300000000		
Encoders	Type	TTL		
Hot Keys	Ref Marks	None		
Print	M.Z. Cnts	0		
Form Chars	Reversed	No		
RS232	Units	MM		
USB				
Measure				

Enter machine zero offset counts if required

2.3 Software setup

- ▶ Highlight the Reversed choice field and then press the YES soft key to reverse the encoder count direction.
- ▶ Highlight the Units choice field and then press the IN or MM soft key for inch or millimeter units of measure.

Encoders		mm	1	+
About	Axis	X		
Display	Res	0.1300000000		
Encoders				
Hot Keys				
Print	Type	TTL		
Form Chars	Ref Marks	None		
RS232	M.Z. Cnts	0		
USB	Reversed	No		
Measure	Units	MM		
No	Yes			

Choose a count direction

Encoders		mm	1	+
About	Axis	X		
Display	Res	0.1300000000		
Encoders				
Hot Keys				
Print	Type	TTL		
Form Chars	Ref Marks	None		
RS232	M.Z. Cnts	0		
USB	Reversed	No		
Measure	Units	MM		
In	MM			

Choose a unit of measure

- ▶ Press the FINISH key to save parameters and return to the setup menu.

Misc screen

The Misc screen encoder configuration fields include:

- Auto DRO counts: The number of least significant DRO counts required to refresh the DRO with new axis values.
- External axis-zero enable for X, Y, Z and Q axes. Allows axes to be zeroed remotely from encoder zero buttons.
- Slew limit for the axes: High input slew rates resulting from rapid input encoder motion can result in erroneous measurements. Erroneous measurements are avoided by displaying encoder error warnings when encoder values change at very high rates.

To configure encoder settings in the Misc screen:

- ▶ Press MENU/SETUP to display the setup menu and then highlight the Misc menu item.
- ▶ Highlight the Auto DRO Cnts data field and enter the number of DRO counts (axis motion) in the least significant digit position required to automatically refresh the DRO axis values.
- ▶ Highlight the X, Y or Z External 0 choice field and then press the YES or NO soft key to enable or disable external axis zeroing by the remote encoder.
- ▶ Highlight the Slew Limit data field and enter the slew rate limit (increments of resolution per second). For example, at a channel resolution of 0.001 mm, a slew rate limit of 50,000 will result in warning messages at encoder motion rates higher than 50 mm per second.

Misc.		mm	1	+
Measure	Key Delay		5	
Sounds	Auto Dro Cnts		20	
Supervisor	X External 0		No	
Squareness	Y External 0		No	
LEC	Z External 0		No	
SLEC	Q External 0		No	
NLEC	OE Timeout (ms)		100	
Scale Factor	OE Debounce (ms)		500	
Misc.	Slew Limit		50000	

Enter Auto DRO counts

Misc.		mm	1	+
Measure	Key Delay		5	
Sounds	Auto Dro Cnts		20	
Supervisor	X External 0		No	
Squareness	Y External 0		No	
LEC	Z External 0		No	
SLEC	Q External 0		No	
NLEC	OE Timeout (ms)		100	
Scale Factor	OE Debounce (ms)		500	
Misc.	Slew Limit		50000	
		No	Yes	

Enable or disable external zeroing for all axes

Misc.		mm	1	+
Measure	Key Delay		5	
Sounds	Auto Dro Cnts		20	
Supervisor	X External 0		No	
Squareness	Y External 0		No	
LEC	Z External 0		No	
SLEC	Q External 0		No	
NLEC	OE Timeout (ms)		100	
Scale Factor	OE Debounce (ms)		500	
Misc.	Slew Limit		50000	

Enter the slew rate limit in encoder counts per second

- ▶ Press the FINISH key to save parameters and return to the setup menu.

Optical edge detection setup

The Edge menu and Misc setup screen contain fields and other tools for configuring optical edge detection.

Edge menu tools

The Edge menu contains tools for installing and calibrating optical edge detection. To install optical edge detection:

- ▶ Turn the ND 1200 and the comparator on to check the optical light levels.
- ▶ Press MENU/EDGE/INSTALL to display the Light Levels screen. Two vertical bars will be shown. The left bar shows the screen sensor light level, and the right bar shows the reference light level. The light levels are relative and extend from 0 to 255.
- ▶ Position the reference cable near the comparator light source to increase the Ref value until it reaches 255, and the left vertical bar reaches the top.
- ▶ Move the stage to position the optical sensor first over a dark area then over an illuminated area of the screen. The SCR value should increase from a low value to a higher value. Acceptable values can be from 10% to 90% of the range indicated by the right vertical bar. A mid value near 128 is ideal, but lower and higher values are satisfactory.

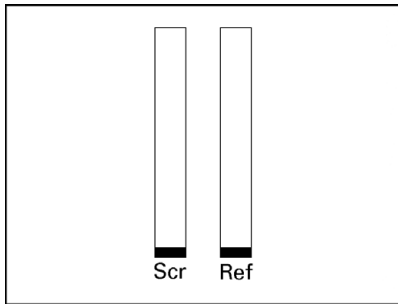

Press MENU/EDGE/INSTALL to display the Light Levels screen and vertical bars

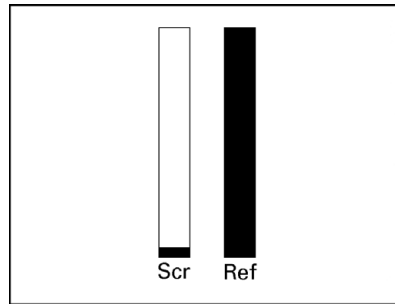

Position the reference cable until the REF value is 255 and the right bar is at the top

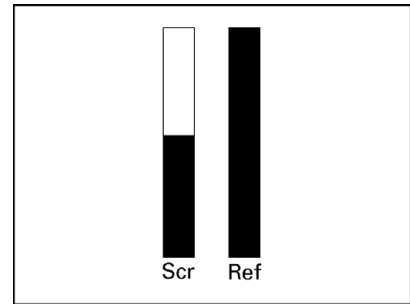

Positioning the sensor over an illuminated area causes the SCR value to increase

- ▶ Press the FINISH key to return to the DRO screen.
- ▶ Calibrate the optical edge detector as described in chapter 1 (See "Calibrate the optical edge detector" on page 33).

Misc screen

The Misc screen contains fields for configuring:

- Optical edge (OE) time-out: The minimum allowed time in milliseconds between the detection of two edges. This time is specified to prevent noise from being recognized as valid edges.
- Optical edge (OE) debounce: The minimum time in milliseconds that a light transition must be stable to result in a valid edge detection.

To configure edge detection in the Misc screen:

- ▶ Press MENU/SETUP to display the setup menu and then highlight the Misc menu item.
- ▶ Highlight the OE Time-out (ms) data field and enter the minimum time between valid edges in milliseconds.
- ▶ Highlight the OE Debounce (ms) data field and enter the minimum time an edge transition must be stable in milliseconds.

Misc.		mm	1	+	
▲	Key Delay		5		
▲	Auto Dro Cnts		20		
Supervisor	X External 0		No		
Squareness	Y External 0		No		
LEC	Z External 0		No		
SLEC	Q External 0		No		
NLEC	OE Timeout (ms)		100		
Scale Factor	OE Debounce (ms)		500		
	Misc.				
	Clock				
▼	Slew Limit		50000		

Enter OE Time-out

Misc.		mm	1	+	
▲	Key Delay		5		
▲	Auto Dro Cnts		20		
Supervisor	X External 0		No		
Squareness	Y External 0		No		
LEC	Z External 0		No		
SLEC	Q External 0		No		
NLEC	OE Timeout (ms)		100		
Scale Factor	OE Debounce (ms)		500		
	Misc.				
	Clock				
▼	Slew Limit		50000		

Enter OE Debounce

- ▶ Press the FINISH key to save parameters and return to the setup menu.

Stage squareness calibration

The Squareness screen contains data and choice fields for calibrating the squareness of the measuring system. The calibration of stage squareness requires the use of a certified square artifact.



Squareness calibration is unnecessary if optional NLEC error correction will be used. Error correction is discussed later in this chapter.

To calibrate squareness:

- ▶ Align the squareness calibration artifact with the reference axis for the squareness calibration. This axis will be the Master axis.
- ▶ Press MENU/SETUP to display the setup menu and then highlight the Squareness menu item.
- ▶ Highlight the Master Axis choice field and press a soft key to choose the reference (Master) axis for squareness calibration.
- ▶ Highlight the Angle data field and press the TEACH soft key to begin the squareness calibration.

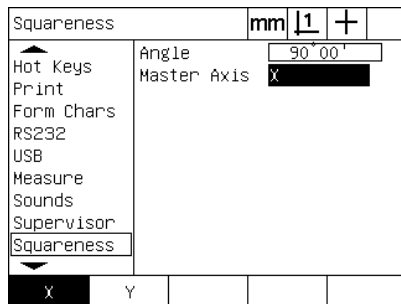

Choose a Master Axis for the calibration

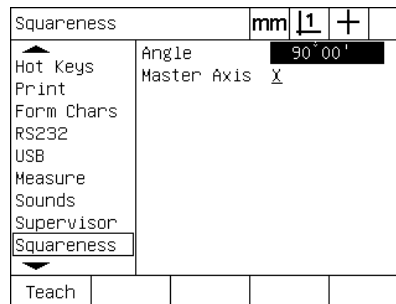

Press the TEACH soft key to begin the calibration

- ▶ Follow instructions displayed on the LCD screen to complete the calibration.
- ▶ Press the FINISH key to save parameters and return to the setup menu.

Error correction

There are three error correction methods used by the ND 1200:

- LEC: Linear Error Correction
- SLEC: Segmented Linear Error Correction
- NLEC: Nonlinear Error Correction

All ND 1200 models are equipped with LEC, SLEC and NLEC. Each method compensates for encoder and machine travel variations with error correction coefficients. Coefficients are determined by comparing actual measurements of a standard to the nominal values imprinted on it.

Linear error correction (LEC) is performed in the LEC setup screen and compensates for variations along an axis using one correction coefficient for the entire range of motion on the axis. For example, an LEC coefficient of 0.0002 per inch applied to a 6 inch measurement along an axis produces a result of 6.0012 inches.

Segmented linear error correction (SLEC) is performed in the SLEC setup screen and compensates for variations along an axis by applying correction values to several individual segments of the measurement range. The use of multiple segments increases the accuracy of measurements beyond the accuracy obtained by applying a single (average) to the entire axis. The correction starting point is mapped to the axis machine zero (MZ Offset) so that the correction coefficients can be applied to each segment location upon power up.

Nonlinear error correction (NLEC) is performed in the NLEC setup screen and compensates for variations in the entire measurement plane created by two axes by applying correction values to a grid of small areas included by the plane. The correction starting point for NLEC is mapped to the machine zeroes of the two axes (MZ Offset) so that the correction coefficients can be accurately applied to each grid area location upon power up.

NLEC can be performed using one of two methods:

- By measuring points on a certified calibration grid with the target ND 1200 system
- By loading correction data from an nlec.txt file contained on a USB drive and created by a IK 5000, ND 1300 or ND 1200 system.



A repeatable machine zero, established by crossing reference marks or defining a manual hard-stop, must be present prior to performing SLEC or NLEC procedures.

Linear error correction (LEC)

LEC compensates for machine irregularities and encoder non-linearities by applying a single linear correction value to the entire range of measurement. To apply LEC to a measurement axis:

- ▶ Verify that the crosshair probe is selected. Press the PROBE soft key to select it if necessary.
- ▶ Press MENU/SETUP to display the setup menu and then highlight the Scale Factor menu item.
- ▶ Verify that the Active choice field specifies NO.



When scale factors are used, they must be applied after error corrections.

- ▶ Highlight the SLEC menu item and verify that the Enabled choice field specifies OFF.
- ▶ Highlight the LEC menu item and make sure that all correction values are 1.0.
- ▶ Highlight the NLEC setup menu item and verify that the NLEC choice field specifies OFF.



LEC can not be performed if a different error correction is already enabled.

Scale Factor		mm	1	+
▲	Active	No		
Supervisor	Multiplier	1.000		
Squareness	User Access	No		
LEC				
SLEC				
NLEC				
Scale Factor				
Misc.				
▼	Clock			

Verify that the Scale Factor is not active

SLEC		mm	1	+
▲	SLEC Axis	X		
Supervisor	Enabled	Off		
Squareness	Station	0		
LEC	Standard			
SLEC	Observed			
NLEC				
Scale Factor	M2 Offset	0.00000		
Misc.				
▼	Clock			

Verify that SLEC compensation is OFF

NLEC		mm	1	+
▲	NLEC	Off		
Supervisor	X Pos	1		
Squareness	Y Pos	1		
LEC	Nominal	Actual		
SLEC	X 0.00000	0.00000		
NLEC	Y 0.00000	0.00000		
Scale Factor	Machine 0	Cell Size		
Misc.	X 0.000	0.000		
▼	Y 0.000	0.000		
Clock	X Grid Size	0		
	Y Grid Size	0		

Verify that NLEC compensation is OFF

- ▶ Position the standard artifact along the measurement axis.
- ▶ Align the artifact as closely as possible to the axis and then perform a skew alignment as described in chapter 1 (see "Align the part to a measurement axis" on page 34).

- ▶ Perform a single measurement of the entire range of motion using the standard artifact and make a note of the result.

 Use an artifact that allows measurements of as much of the axis range of motion as possible.

In this example of applying LEC, one point at end of the axis measurement range is measured using an 8 inch standard.

Arrow number	Descriptions
1: Standard length	Entire 8 inch length is measured
2: Standard values	The certified length of the standard
3: Observed values	The measured length of the standard
4: Deviation graph	Difference between standard and observed values (not entered into any screen)

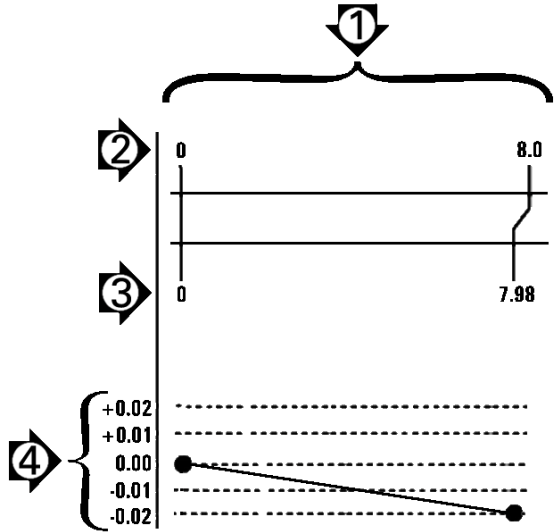

To perform the linear error correction in the LEC screen:

- ▶ Highlight the LEC menu item.
- ▶ Enter the Standard value of the artifact and the Observed value measured by the ND 1200 for the measurement axis. This example shows Standard and Observed values for the X axis.

 The standard and observed values for axes should be 1.000 when no LEC correction is applied.

LEC example using an 8 inch standard

LEC		mm	1	+
Linear Error Correction				
Sounds	X Standard	1.000		
Supervisor	X Observed	1.000		
Squareness	Y Standard	1.000		
LEC	Y Observed	1.000		
SLEC	Z Standard	1.000		
NLEC	Z Observed	1.000		
Scale Factor				
Misc.				
Clock				

Highlight the LEC screen

LEC		mm	1	+
Linear Error Correction				
Sounds	X Standard	8.000		
Supervisor	X Observed	7.980		
Squareness	Y Standard	1.000		
LEC	Y Observed	1.000		
SLEC	Z Standard	1.000		
NLEC	Z Observed	1.000		
Scale Factor				
Misc.				
Clock				

Enter the standard and observed values for the axis

- ▶ Perform LEC on other axes if desired and then press the FINISH key to save parameters and return to the setup menu.

Segmented linear error correction (SLEC)

SLEC compensates for machine irregularities and encoder non-linearities by applying correction values to individual segments that cover the entire range of motion along an axis. To apply SLEC to a measurement axis:

- ▶ Verify that the crosshair probe is selected. Press the PROBE soft key to select it if necessary.
- ▶ Verify that the appropriate encoder reference marks are selected in the Encoders setup screen (See "Encoders screen" on page 92).
- ▶ Verify that the Startup zero field of the Measure setup screen is set to YES (See "Measure screen" on page 112).
- ▶ Cycle the ND 1200 power off and then back on to establish the machine zero if necessary.



Reference marks, or a manual reference position must be recognized by the ND 1200 upon startup to create a repeatable machine zero. Machine zero is required for SLEC error correction.

- ▶ Press MENU/SETUP to display the setup menu and then highlight the Scale Factor menu item.
- ▶ Verify that the Active choice field specifies NO.



When scale factors are used, they must be applied after error corrections.

- ▶ Press MENU/SETUP to display the setup menu and then highlight the LEC menu item.
- ▶ Verify that all Standard and Observed data fields contain the value: 1.000 to eliminate the possibility that a previous LEC correction will influence this SLEC correction.
- ▶ Highlight the NLEC setup menu item and verify that the NLEC choice field specifies OFF.



SLEC can not be performed if a different error correction is already enabled.

- ▶ Highlight the SLEC setup menu item and verify that the Enabled choice field is OFF. SLEC correction can not be configured while SLEC is enabled.

LEC		mm	1	+
Linear Error Correction				
Sounds	X Standard	1.000		
Supervisor	X Observed	1.000		
Squareness	Y Standard	1.000		
LEC	Y Observed	1.000		
SLEC	Z Standard	1.000		
NLEC	Z Observed	1.000		
Scale Factor				
Misc.				
Clock				

Verify that values in the LEC screen are all 1.000

NLEC		mm	1	+
NLEC				
Sounds	X Pos	1		
Supervisor	Y Pos	1		
Squareness	Nominal	Actual		
LEC	X 0.00000	0.00000		
SLEC	Y 0.00000	0.00000		
NLEC	Machine 0	Cell Size		
Scale Factor	X 0.000	0.000		
Misc.	Y 0.000	0.000		
Clock	X Grid Size	0		
	Y Grid Size	0		

Verify that NLEC (optional) compensation is OFF

SLEC		in	1	+
SLEC				
Sounds	SLEC Axis	X		
Supervisor	Enabled	Off		
Squareness	Station	0		
LEC	Standard			
SLEC	Observed			
NLEC				
Scale Factor	MZ Offset	0.00000		
Misc.				
Clock				
	Off	On		

Verify that the SLEC enable is OFF

- ▶ Press MENU/CLEAR/CLR ALL to clear all existing datums, part alignments and part data.
- ▶ Position the standard artifact along the measurement axis.
- ▶ Align the artifact as closely as possible to the axis and then perform a skew alignment as described in chapter 1 (see "Align the part to a measurement axis" on page 34).

In this example of applying SLEC, 4 points equally spaced along the measurement range are measured using an 4 inch standard.

Arrow number	Descriptions
1: Standard length	Entire 4 inch length is measured
2: Standard values	The certified values shown on the standard
3: Observed values	The measured values
4: Deviation graph	Difference between standard and observed values (not entered into any screen)
5: Station numbers	Segment end points (standard and observed values) are entered into station data fields

The deviation graph in the example at the right shows a datum zero point and 4 certified and (corresponding) measured points. The certified value at the end of each segment is entered into the Standard data field manually using the KEYPAD. The actual measured value at the end of each segment is entered into the Observed field automatically by pressing the TEACH softkey.

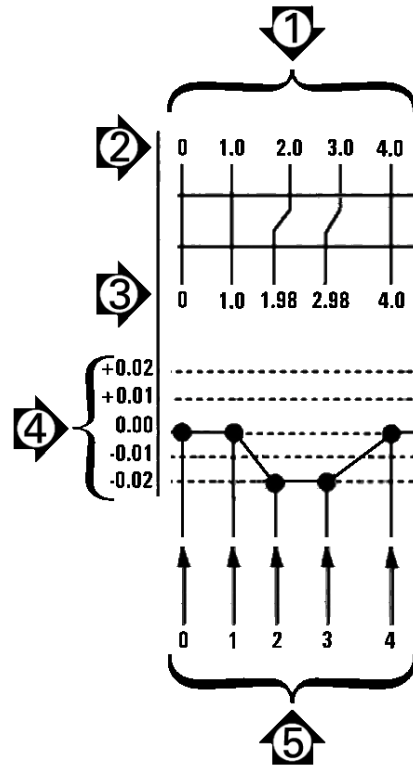

SLEC example using an 8 inch standard

To configure segmented linear error correction in the SLEC screen:

- ▶ Position the crosshair probe is over the zero reference of the standard artifact and press the AXIS key to zero the axis at the zero position of the standard.
- ▶ Highlight the SLEC menu item.
- ▶ Highlight the Axis choice field and select the axis for correction.
- ▶ Highlight the MZ Offset data field and press the TEACH soft key. The offset between the zero reference location of the standard and the machine zero will be entered by the ND 1200.
- ▶ Highlight the Station field. The station must be zero at the beginning of the SLEC procedure. Enter zero values into the Standard and Observed data fields to define the zero station as the reference.

SLEC		in	1	+
↑	SLEC Axis	X		
Supervisor	Enabled	Off		
Squareness	Station	0		
LEC	Standard			
SLEC	Observed			
NLEC				
Scale Factor	MZ Offset	0.00000		
Misc.				
Clock				
↓				
X	Y	Z		

Select the axis for SLEC

SLEC		in	1	+
↑	SLEC Axis	X		
Supervisor	Enabled	Off		
Squareness	Station	0		
LEC	Standard			
SLEC	Observed			
NLEC				
Scale Factor	MZ Offset	0.285		
Misc.				
Clock				
↓				
Teach				

Press the TEACH soft key to enter a machine zero offset

SLEC		in	1	+
↑	SLEC Axis	X		
Supervisor	Enabled	Off		
Squareness	Station	0		
LEC	Standard	0.000		
SLEC	Observed	0.000		
NLEC				
Scale Factor	MZ Offset	0.28500		
Misc.				
Clock				
↓				
Teach				

Enter zeros into the Standard and Observed fields of Station 0

- ▶ Position the crosshairs over the end of segment 1 on the standard, highlight the Station field again and press the INC soft key to advance the station number to 1.
- ▶ Highlight the Standard field and enter the Standard value at the end of segment 1. In the example, the value is 1.00000. Then highlight the Observed field and press the TEACH soft key. The system will enter the value measured at the end of the segment. In the example the Observed value at Station 1 is also 1.00000. Highlight the Station field again and press the INC soft key to advance the station number to 2.
- ▶ Position the crosshairs over the end of segment 2 on the standard, highlight the Station field again and press the INC soft key to advance the station number to 2.
- ▶ Highlight the Standard field and enter the Standard value at the end of segment 2. In the example, the value is 2.00000. Then highlight the Observed field and press the TEACH soft key. The system will enter the value measured at the end of the segment. In the example the Observed value at Station 2 is 1.98000.
- ▶ Position the crosshairs over the end of segment 3 on the standard, highlight the Station field again and press the INC soft key to advance the station number to 3.

- ▶ Highlight the Standard field and enter the Standard value at the end of segment 3. In the example, the value is 3.00000. Then highlight the Observed field and press the TEACH soft key. The system will enter the value measured at the end of the segment. In the example the Observed value at Station 3 is 2.98000.

SLEC		mm	1	+
▲ Sounds Supervisor	SLEC Axis Enabled	X	Off	
Squareness	Station	1		
LEC	Standard	1.000		
SLEC	Observed	1.000		
NLEC				
Scale Factor	MZ Offset	0.28500		
Misc. Clock				
▼				
Teach				

Enter Standard value and TEACH the Observed value for Station 1

SLEC		mm	1	+
▲ Sounds Supervisor	SLEC Axis Enabled	X	Off	
Squareness	Station	2		
LEC	Standard	2.000		
SLEC	Observed	1.980		
NLEC				
Scale Factor	MZ Offset	0.28500		
Misc. Clock				
▼				
Teach				

Enter Standard value and TEACH the Observed value for Station 2

SLEC		mm	1	+
▲ Sounds Supervisor	SLEC Axis Enabled	X	Off	
Squareness	Station	3		
LEC	Standard	3.000		
SLEC	Observed	2.980		
NLEC				
Scale Factor	MZ Offset	0.28500		
Misc. Clock				
▼				
Teach				

Enter Standard value and TEACH the Observed value for Station 3

- ▶ Position the crosshairs over the end of segment 4 on the standard, highlight the Station field again and press the INC soft key to advance the station number to 4. This is the last station in the example.
- ▶ Highlight the Standard field and enter the Standard value at the end of segment 4. In the example, the value is 4.00000. Then highlight the Observed field and press the TEACH soft key. The system will enter the value measured at the end of the segment. In the example the Observed value at Station 4 is 4.0000.

SLEC		mm	1	+
▲ Sounds Supervisor	SLEC Axis Enabled	X	Off	
Squareness	Station	4		
LEC	Standard	4.000		
SLEC	Observed	4.000		
NLEC				
Scale Factor	MZ Offset	0.28500		
Misc. Clock				
▼				
Teach				

Enter Standard value and TEACH the Observed value for Station 4

SLEC		mm	1	+
▲ Sounds Supervisor	SLEC Axis Enabled	X	On	
Squareness	Station	4		
LEC	Standard	4.000		
SLEC	Observed	4.00000		
NLEC				
Scale Factor	MZ Offset	0.28500		
Misc. Clock				
▼				
Off	On			

Press the ON softkey when all desired axes have been compensated

- ▶ Repeat the SLEC process for other axes if necessary.
- ▶ When SLEC data are entered for all the desired axes, highlight the Enabled field for each axis and press the On soft key to activate SLEC for each axis.
- ▶ Press the FINISH key to save parameters and return to the setup menu.

Nonlinear error correction (NLEC)

NLEC minimizes or eliminates the small inaccuracies in the X-Y measurement plane due to machine irregularities and encoder nonlinearity. Error correction coefficients are obtained by measuring a certified calibration grid. The actual values are then compared to the nominal grid values by the ND 1200. This comparison results in a final NLEC.txt file that contains the error corrections for all measured grid locations. When NLEC is enabled, the corrections are applied across the measured area of the X-Y measurement plane. To apply NLEC to a measurement plane:

- ▶ Verify that the crosshair probe is selected. Press the PROBE soft key to select it if necessary.
- ▶ Verify that the appropriate encoder reference marks are selected in the Encoders setup screen (See "Encoders screen" on page 92).
- ▶ Verify that the Startup zero field of the Measure setup screen is set to YES (See "Measure screen" on page 112).
- ▶ Cycle the ND 1200 power off and then back on to establish the machine zero if necessary.



Reference marks, or a manual reference position must be recognized by the ND 1200 upon startup to create a repeatable machine zero. Machine zero is required for NLEC error correction.

- ▶ Press MENU/SETUP to display the setup menu and then highlight the Scale Factor menu item.
- ▶ Verify that the Active choice field specifies NO.



When scale factors are used, they must be applied after error corrections.

- ▶ Press MENU/CLEAR/CLR ALL to clear all existing datums, part alignments and part data.
- ▶ Press MENU/SETUP to display the setup menu and then highlight the LEC menu item.
- ▶ Verify that all Standard and Observed data fields contain the value: 1.000 to eliminate the possibility that a previous LEC correction will influence this NLEC correction.

- ▶ Highlight the SLEC setup menu item (if NLEC is present) and verify that the Enabled choice field specifies OFF.

 NLEC can not be performed if a different error correction is already enabled.

- ▶ NLEC correction can not be configured while NLEC is enabled. Highlight the NLEC setup menu item and verify that the NLEC choice field specifies OFF.

LEC	mm	1	+
Linear Error Correction			
Sounds	X Standard	1.000	
Supervisor	X Observed	1.000	
Squareness	Y Standard	1.000	
LEC	Y Observed	1.000	
SLEC	Z Standard	1.000	
NLEC	Z Observed	1.000	
Scale Factor			
Misc.			
Clock			

Verify that values in the LEC screen are all 1.000

SLEC	mm	1	+
SLEC Axis	X		
Enabled	Off		
Station	0		
Standard			
Observed			
M2 Offset	0.00000		

Verify that SLEC Enable is OFF

NLEC	mm	1	+
NLEC	Off		
X Pos	1		
Y Pos	1		
Nominal	Actual		
X 0.00000	0.00000		
Y 0.00000	0.00000		
Machine 0	Cell Size		
X 0.000	0.000		
Y 0.000	0.000		
X Grid Size	0		
Y Grid Size	0		

Verify that the NLEC is OFF

Once these initial steps have been completed, NLEC error correction can be performed using one of two methods:

- By measuring points on a calibration grid
- By importing an nlec.txt file created using a calibration grid and a ND 1200, ND 1300 or IK 5000

In the example of applying NLEC, nine points are measured using a 3 X 3 calibration grid.

Arrow number	Descriptions
1: Grid alignment	A Skew alignment is performed to align the grid perfectly to the X axis.
2: Datum and grid data points	A zero datum is created at the lower left corner of the grid. This is the first position (X=1,Y=1) that will be entered into the NLEC setup screen. Other calibration data points to be entered into the NLEC setup screen are also shown in the X,Y format (1,1 through 3,3 in this example).

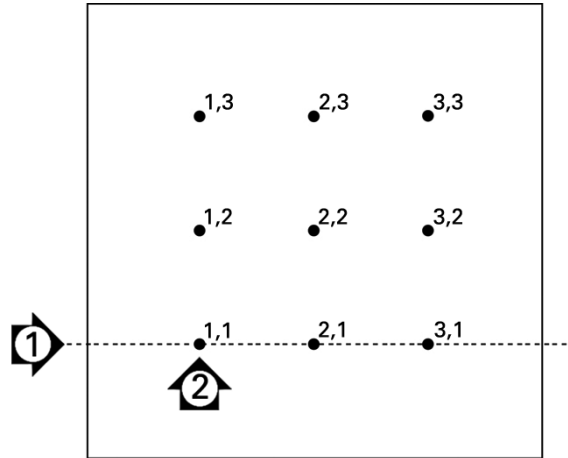

Nine points of a 3 X 3 calibration grid are shown with numeric X,Y grid locations

NLEC by measuring points on a calibration grid

- ▶ Position the standard artifact along the measurement axis.
- ▶ Align the artifact as closely as possible to the axis and then perform a skew alignment as described in chapter 1 (see "Align the part to a measurement axis" on page 34).
- ▶ Create a reference datum by probing the point at the 1,1 position of the calibration grid and pressing the X and Y AXIS keys to zero the point.
- ▶ While the crosshair probe is positioned over the 1,1 grid point (datum), highlight the NLEC setup menu item. Highlight the X and Y Grid Size data fields and enter the number of calibration points in the X and Y axes. In the example, 3 points were entered in the X and Y Grid Size fields to describe the 3 X 3 calibration grid.
- ▶ Highlight the X and Y Cell Size data fields and enter the distance between calibration points on the X and Y axes. In the example, the distance between points is 1 inch (25.4cm) on the X and Y axes. Highlight the Machine 0 X or Y data field and press the USE CUR soft key to enter the offset from the ND 1200 machine zero and the calibration grid datum. The offsets for both axes will be entered and displayed automatically by the ND 1200.

NLEC		in	1	+
▲	NLEC		Off	
Sounds	X Pos		1	
Supervisor	Y Pos		1	
Squareness	Nominal		Actual	
LEC	X 0.00000		0.00000	
SLEC	Y 0.00000		0.00000	
NLEC	Machine 0		Cell Size	
Scale Factor	X 0.000		0.000	
Misc.	Y 0.000		0.000	
Clock	X Grid Size		3	
▼	Y Grid Size		3	
				Teach

Enter the X and Y calibration grid size

NLEC		in	1	+
▲	NLEC		Off	
Sounds	X Pos		1	
Supervisor	Y Pos		1	
Squareness	Nominal		Actual	
LEC	X 0.00000		0.00000	
SLEC	Y 0.00000		0.00000	
NLEC	Machine 0		Cell Size	
Scale Factor	X 0.000		1.000	
Misc.	Y 0.000		1.000	
Clock	X Grid Size		3	
▼	Y Grid Size		3	
				Teach

Enter the X and Y cell size

NLEC		in	1	+
▲	NLEC		Off	
Sounds	X Pos		1	
Supervisor	Y Pos		1	
Squareness	Nominal		Actual	
LEC	X 0.00000		0.00000	
SLEC	Y 0.00000		0.00000	
NLEC	Machine 0		Cell Size	
Scale Factor	X 0.025		1.000	
Misc.	Y 0.425		1.000	
Clock	X Grid Size		3	
▼	Y Grid Size		3	
Use Cur				Teach

Enter the machine zero offset

- ▶ Highlight the X Pos data field. Initially the X Pos and Y Pos fields will contain values of 1. These values are incremented by the ND 1200 as the calibration is performed. Press the TEACH soft key to begin the NLEC calibration, then follow the instructions provided on the screen for conducting measurements. Grid measurement locations are indicated in the top left corner of the DRO screen during measurements. Upon completion of the grid measurements the nominal (certified) and actual (measured) values will be displayed in the Nominal and Actual data fields for each grid position.

NLEC strn. 1, 1		in	1	+
Pts	X	0.000		
0	Y	0.000		
	Z	0.000		
	Q	0.000		
DRO				
Probe	.			

Grid measurement locations are indicated in the top left corner of the screen.

NLEC		in	1	+
Sounds	NLEC	Off		
Supervisor	X Pos	3		
	Y Pos	3		
Squareness	Nominal	Actual		
LEC	X 2.00000	2.00000		
SLEC	Y 2.00000	2.00000		
NLEC	Machine 0	Cell Size		
Scale Factor	X 0.026	1.000		
Misc.	Y 0.425	1.000		
Clock	X Grid Size	3		
	Y Grid Size	3		
Dec	Inc			Teach

Nominal and actual grid values are displayed when the calibration is complete

NLEC		in	1	+
Sounds	NLEC	On		
Supervisor	X Pos	3		
	Y Pos	3		
Squareness	Nominal	Actual		
LEC	X 2.00000	2.00000		
SLEC	Y 2.00000	2.00000		
NLEC	Machine 0	Cell Size		
Scale Factor	X 0.026	1.000		
Misc.	Y 0.425	1.000		
Clock	X Grid Size	3		
	Y Grid Size	3		
Off	On	Load	Save	Teach

Press the ON soft key to enable NLEC

- Highlight the NLEC choice field and press the ON soft key to enable NLEC correction. Then press the FINISH key to save parameters and return to the setup menu.

NLEC by importing an nlec.txt file

An nlec.txt file created by measuring a certified calibration grid with a IK 5000, ND 1300 or ND 1200 can be used to provide NLEC correction data instead of measuring a calibration grid with the target ND 1200 system. The nlec.txt file is simply loaded from a USB flash drive.



The nlec.txt file must be loaded from the root of an otherwise empty USB drive.

To load an nlec.txt file:

- ▶ Insert the USB drive into the ND 1200 USB port when the ND 1200 power is off.
- ▶ Turn the ND 1200 power on and press the FINISH key display the DRO screen.
- ▶ Press MENU/SETUP to display the setup menu, enter the supervisor password into the Supervisor setup screen and then highlight the NLEC menu item.
- ▶ Verify that the NLEC choice field is off.
- ▶ Highlight the NLEC choice field and press the LOAD soft key. The correction data will be transferred to the ND 1200 from the nlec.txt file. Upon completion the nominal (certified) and actual (measured) values will be displayed in the Nominal and Actual data fields for each grid position.
- ▶ Highlight the NLEC choice field and press the ON soft key to enable NLEC correction. Then press the FINISH key to save parameters and return to the setup menu.

Saving NLEC correction data as an nlec.txt file

NLEC correction data can be saved to a USB flash drive for backup storage or for transfer to another ND 1200 system as an nlec.txt file. The nlec.txt file is simply saved to a USB flash drive.



The nlec.txt file must be saved to the root of an otherwise empty USB drive.

To save an nlec.txt file:

- ▶ Insert the USB drive into the ND 1200 USB port when the ND 1200 power is off.
- ▶ Turn the ND 1200 power on and press the FINISH key display the DRO screen.
- ▶ Press MENU/SETUP to display the setup menu enter the supervisor password into the Supervisor setup screen and then highlight the NLEC menu item.
- ▶ Highlight the NLEC choice field and press the SAVE soft key. The NLEC correction data will be transferred to the USB drive from the ND 1200.
- ▶ Press the FINISH key to return to the setup menu.

Measurement scaling for parts that expand or shrink

Scale factors scale measurement results using a multiplier and are useful when measuring parts that will expand or shrink after inspections have been performed.

Scale Factor screen

The Scale Factor screen contains configuration fields for:

- Enabling scale factor
- Specifying a scale factor multiplier value
- Providing the user access to scale factor editing

To configure scale factor settings:

- ▶ Press MENU/SETUP to display the setup menu and then highlight the Scale Factor menu item.

 The setup process for all axes is identical and uses the Encoders and Misc setup screens.

- ▶ Highlight the Multiplier data field and enter the scale factor multiplier.
- ▶ Highlight the User Settable choice field and press the NO soft key to restrict access to those who can provide the supervisor password, or the YES soft key to provide unrestricted access.

 Password restricted access to setup parameters is explained earlier on page 87.

- ▶ Highlight the Active choice field and press the NO soft key to disable the scale factor or the YES soft key to enable it.

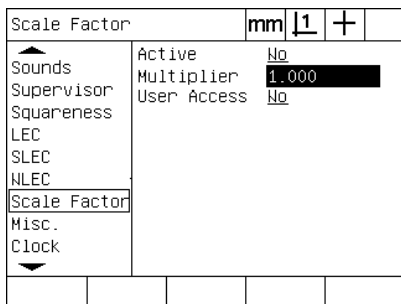

Enter the scale factor multiplier

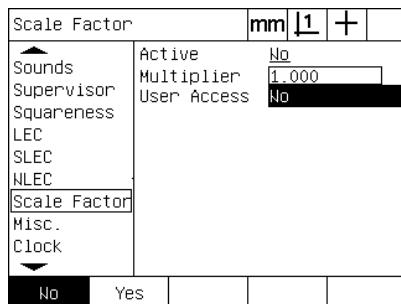

Select NO to restrict access or YES to allow user access to scale factor editing

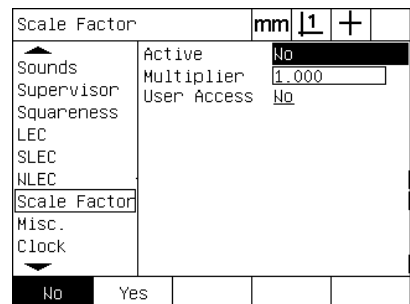

Select NO to disable or YES to enable scale factor

- ▶ Press the FINISH key to return to the setup menu.

Measurement configuration

The Measure screen contains data and choice fields for configuring ND 1200 measurement parameters.

Measure screen

The Measure screen contains configuration fields for:

- Specifying forward or backward annotation point probing
- Retaining features across power cycles
- Specifying absolute or signed distances
- Requiring a machine zero upon startup
- Specifying a probing targeting zone size for programs that utilize optical edge detection
- Specifying program pauses if tolerance failures are encountered
- Specifying printed reports depending on tolerance results

To configure measurement parameters:

- ▶ Press MENU/SETUP to display the setup menu and then highlight the Measure menu item.
- ▶ Highlight the Annotation choice field and then press the BACK soft key to allow the user to probe up to 100 points when measuring a feature. Press the FORW soft key to complete a feature measurement automatically when the number of points specified by the Fwd data fields have been probed. For example, when FORW is selected and the Fwd Circle value is 3, a circle measurement will be completed automatically when 3 points have been probed.
- ▶ Highlight each of the Fwd feature data fields and enter the number of probed points required to automatically complete a measurement for each feature type when forward annotation is used. The minimum numbers are:

Point	1 probed point
Line	2 probed points
Circle	3 probed points

Measure		mm	1	+
About	Annotation	Back.		
Display	Fwd Point	1		
Encoders	Fwd Line	2		
Hot Keys	Fwd Circle	3		
Print	Retain Features	Yes		
Form Chars	Distances	Abs		
RS232	Startup Zero	No		
USB	Targeting Zone	1.000		
Measure	Pause Tol Res	If Fail		
	Print Tol Res	Never		
Back.		Forw.		

Select backward or forward annotation

Measure		mm	1	+
About	Annotation	Back.		
Display	Fwd Point	1		
Encoders	Fwd Line	2		
Hot Keys	Fwd Circle	3		
Print	Retain Features	Yes		
Form Chars	Distances	Abs		
RS232	Startup Zero	No		
USB	Targeting Zone	1.000		
Measure	Pause Tol Res	If Fail		
	Print Tol Res	Never		

Enter the minimum number of points for forward annotation probing

- ▶ Highlight the Retain features choice field and then press the YES soft key to retain features in the feature list across power cycles. Press the NO soft key if discarding features when the power is turned off is preferred.
- ▶ Highlight the Distances choice field and press the SIGNED soft key to display + and - distances. Press the ABS soft key to display distances as absolute values.
- ▶ Highlight the Startup zero choice field and press the YES soft key to require a machine zero upon startup by crossing reference marks or by prompting the user for a hard stop. Press the no soft key if no machine zero is required.

 A machine zero is required when SLEC or NLEC error correction is used.

Measure		mm	1	+	
About	Annotation		Back.		
Display	Fwd Point	1			
Encoders	Fwd Line	2			
Hot Keys	Fwd Circle	3			
Print	Retain Features	Yes			
Form Chars	Distances	Abs			
RS232	Startup Zero	No			
USB	Targeting Zone	1.000			
Measure	Pause Tol Res	If Fail			
	Print Tol Res	Never			
		No	Yes		

Select YES to retain features across power cycles

Measure		mm	1	+	
About	Annotation		Back.		
Display	Fwd Point	1			
Encoders	Fwd Line	2			
Hot Keys	Fwd Circle	3			
Print	Retain Features	Yes			
Form Chars	Distances	Abs			
RS232	Startup Zero	No			
USB	Targeting Zone	1.000			
Measure	Pause Tol Res	If Fail			
	Print Tol Res	Never			
		Signed	Abs		

Select ABS to display distances without + and - signs

Measure		mm	1	+	
About	Annotation		Back.		
Display	Fwd Point	1			
Encoders	Fwd Line	2			
Hot Keys	Fwd Circle	3			
Print	Retain Features	Yes			
Form Chars	Distances	Abs			
RS232	Startup Zero	No			
USB	Targeting Zone	1.000			
Measure	Pause Tol Res	If Fail			
	Print Tol Res	Never			
		No	Yes		

Select YES to require a machine zero upon startup

- ▶ Highlight the Targeting zone data field and enter the target box size displayed when running a program that uses optical edge detection for part probing. Points outside the target zone box will not be recognized when the program is running.
- ▶ Highlight the Pause Tol Results choice field and press the desired soft key to pause program execution in response to tolerance tests:

Soft key	Result
Never	Never pauses a program in response to tolerance results
If Fail	Pauses a program if a tolerance fails
If Pass	Pauses a program if a tolerance passes
Always	Pauses a program after each tolerance test

- ▶ Highlight the Print Tol Results choice field and press the desired soft key to print a report in response to tolerance tests:

Soft key	Result
Never	Never prints a report in response to tolerance results
If Fail	Prints a report a program if a tolerance fails
If Pass	Prints a report if a tolerance passes
Always	Prints a report after each tolerance test

Measure	mm	↓	1	+	
About	Annotation	Back..			
Display	Fwd Point	1			
Encoders	Fwd Line	2			
Hot Keys	Fwd Circle	3			
Print	Retain Features	Yes			
Form Chars	Distances	Abs			
RS232	Startup Zero	No			
USB	Targeting Zone	1.000			
Measure	Pause Tol Res	If Fail			
	Print Tol Res	Never			

Enter a targeting zone for edge detection programs

Measure	mm	↓	1	+	
About	Annotation	Back..			
Display	Fwd Point	1			
Encoders	Fwd Line	2			
Hot Keys	Fwd Circle	3			
Print	Retain Features	Yes			
Form Chars	Distances	Abs			
RS232	Startup Zero	No			
USB	Targeting Zone	1.000			
Measure	Pause Tol Res	If Fail			
	Print Tol Res	Never			

Select a program pause in response to tolerance testing

Measure	mm	↓	1	+	
About	Annotation	Back..			
Display	Fwd Point	1			
Encoders	Fwd Line	2			
Hot Keys	Fwd Circle	3			
Print	Retain Features	Yes			
Form Chars	Distances	Abs			
RS232	Startup Zero	No			
USB	Targeting Zone	1.000			
Measure	Pause Tol Res	If Fail			
	Print Tol Res	Never			

Select report printing in response to tolerance testing

- ▶ Press the FINISH key to return to the setup menu.

Display formatting

The Display screen contains data and choice fields for configuring display resolution and other display parameters.

Display screen

The Display screen configuration fields include:

- Resolutions for linear and angular measurements
- Startup linear and angular units of measure
- Selection of a comma or decimal point radix
- Unit of angular measurement for the current session
- Angular display resolutions for the Q-axis
- Range of displayed angles for angular measurements

To configure display settings:

- ▶ Press MENU/SETUP to display the setup menu and then highlight the Display menu item.
- ▶ Highlight the MM and Inch Disp Res data fields and enter the display resolution index numbers for each unit of measure. For example, an index number of 0.001 will round the display of MM or inch to 3 digits to the right of the radix character.
- ▶ Highlight the DMS Disp Res data field and enter the Degree/Minutes/Seconds index number. For example, an index number of 0.01 will round the display of 30°20'45" to 30°21'.
- ▶ Highlight the DD Disp Res data field and enter the Decimal Degrees index number. For example, an index number of 0.01 will round the display of 30.786 degrees to 30.79 degrees.

Display		mm	1	+
About	MM Disp Res	0.001		
Display	Inch Disp Res	0.001		
Encoders	DMS Disp Res	0.01		
Hot Keys	DD Disp Res	0.001		
Print	Startup Linear	MM		
Form Chars	Startup Angular	DMS		
RS232	Radix	Decimal		
USB	Current Angular	DMS		
Measure	Q DMS Disp Res	0.01		
	Q DD Disp Res	0.001		
	Angle Display	--+360		

Enter the display resolution index numbers for linear measurements

Display		mm	1	+
About	MM Disp Res	0.001		
Display	Inch Disp Res	0.001		
Encoders	DMS Disp Res	0.01		
Hot Keys	DD Disp Res	0.001		
Print	Startup Linear	MM		
Form Chars	Startup Angular	DMS		
RS232	Radix	Decimal		
USB	Current Angular	DMS		
Measure	Q DMS Disp Res	0.01		
	Q DD Disp Res	0.001		
	Angle Display	--+360		

Enter the display resolution index number for angular measurements in Degrees/Minutes/Seconds

Display		mm	1	+
About	MM Disp Res	0.001		
Display	Inch Disp Res	0.001		
Encoders	DMS Disp Res	0.01		
Hot Keys	DD Disp Res	0.001		
Print	Startup Linear	MM		
Form Chars	Startup Angular	DMS		
RS232	Radix	Decimal		
USB	Current Angular	DMS		
Measure	Q DMS Disp Res	0.01		
	Q DD Disp Res	0.001		
	Angle Display	--+360		

Enter the display resolution index number for angular measurements in Decimal Degrees

- ▶ Highlight the Startup Linear choice field and press a soft key to specify a unit of linear measure set by the ND 1200 upon startup. Soft key selections are:

Soft key	Result
MM	The linear unit of measure will be millimeters
Inch	The linear unit of measure will be inches
Last	The linear unit of measure will not be changed

- ▶ Highlight the Startup Angular choice field and press a soft key to specify a unit of angular measure set by the ND 1200 upon startup. Soft key selections are:

Soft key	Result
DD	The angular unit of measure will be Decimal Degrees
DMS	The angular unit of measure will be Degree Minutes Seconds
Last	The angular unit of measure will not be changed

- ▶ Highlight the Radix choice field and press a soft key to select a Decimal or Comma radix.

Display	mm	↓	1	+
About	MM Disp Res	0.001		
Display	Inch Disp Res	0.001		
Encoders	DMS Disp Res	0.01		
Hot Keys	DD Disp Res	0.001		
Print	Startup Linear	MM		
Form Chars	Startup Angular	DMS		
RS232	Radix	Decimal		
USB	Current Angular	DMS		
Measure	Q DMS Disp Res	0.01		
	Q DD Disp Res	0.001		
	Angle Display	--+360		
	MM	Inch	Last	

Select a startup linear unit of measure

Display	mm	↓	1	+
About	MM Disp Res	0.001		
Display	Inch Disp Res	0.001		
Encoders	DMS Disp Res	0.01		
Hot Keys	DD Disp Res	0.001		
Print	Startup Linear	MM		
Form Chars	Startup Angular	DMS		
RS232	Radix	Decimal		
USB	Current Angular	DMS		
Measure	Q DMS Disp Res	0.01		
	Q DD Disp Res	0.001		
	Angle Display	--+360		
	DD	DMS	Last	

Select a startup angular unit of measure

Display	mm	↓	1	+
About	MM Disp Res	0.001		
Display	Inch Disp Res	0.001		
Encoders	DMS Disp Res	0.01		
Hot Keys	DD Disp Res	0.001		
Print	Startup Linear	MM		
Form Chars	Startup Angular	DMS		
RS232	Radix	Decimal		
USB	Current Angular	DMS		
Measure	Q DMS Disp Res	0.01		
	Q DD Disp Res	0.001		
	Angle Display	--+360		
	Decimal	Comma		

Select a radix

- ▶ Highlight the Current Angular choice field and press a soft key to set the current session to Decimal Degrees (DD), or Degrees/Minutes/Seconds (DMS).
- ▶ Highlight the Q DMS and Q DD Res data fields and enter the display resolution index numbers for each of the angular units of measure. The Q DMS and Q DD Disp Res fields configure the protractor readings shown on the DRO.
- ▶ Highlight the Angle Display choice field and press a soft key to select the desired protractor angle display format.

Display	mm	1	+
About	MM Disp Res	0.001	
Display	Inch Disp Res	0.001	
Encoders	DMS Disp Res	0.01	
Hot Keys	DD Disp Res	0.001	
Print	Startup Linear	MM	
Form Chars	Startup Angular	DMS	
RS232	Radix	Decimal	
USB	Current Angular	DMS	
Measure	Q DMS Disp Res	0.01	
	Q DD Disp Res	0.001	
	Angle Display	--+360	
DD	DMS		

Set the display of angles for the current session

Display	mm	1	+
About	MM Disp Res	0.001	
Display	Inch Disp Res	0.001	
Encoders	DMS Disp Res	0.01	
Hot Keys	DD Disp Res	0.001	
Print	Startup Linear	MM	
Form Chars	Startup Angular	DMS	
RS232	Radix	Decimal	
USB	Current Angular	DMS	
Measure	Q DMS Disp Res	0.01	
	Q DD Disp Res	0.001	
	Angle Display	--+360	

Enter the display resolution index number for the Q-axis in DMS and DD protractor readings

Display	mm	1	+
About	MM Disp Res	0.001	
Display	Inch Disp Res	0.001	
Encoders	DMS Disp Res	0.01	
Hot Keys	DD Disp Res	0.001	
Print	Startup Linear	MM	
Form Chars	Startup Angular	DMS	
RS232	Radix	Decimal	
USB	Current Angular	DMS	
Measure	Q DMS Disp Res	0.01	
	Q DD Disp Res	0.001	
	Angle Display	--+360	
--+360	0,360	--+180	

Select the desired protractor angle display format

Hot key assignments

The Hot Keys setup screen is used to map frequently used functions to front panel keys, remote keypad keys and foot switch keys. Hot keys can save time by eliminating the need to navigate through menus to initiate a function, or by making a function more accessible through a foot switch or remote keypad.

ND 1200 keys and switches that are available for hot key mapping are shown here:

Arrow number	Descriptions
1	Wide keys
2	Soft keys
3	Unit keys
4	Remote keys
5	Foot switch 1
6	Foot switch 2

 The remote foot switch and keypad are optional accessories that are purchased separately.

Hot keys screen

The Hot Keys screen configuration fields include:

- Key type or switch type
- Specific key or switch for hot key assignment
- Function to assign to the key or switch



Front panel keys available for hot key mapping



Remote keys and switches available for hot key mapping

To assign a function to a hot key:

- ▶ Press MENU/SETUP to display the setup menu and then highlight the Hot keys menu item.
- ▶ Highlight the Keys choice field and then press a soft key to select the desired key type or switch type. In this example the Foot switch type is selected.
- ▶ Highlight a specific key or switch. In this example foot switch 2 is selected.
- ▶ Press a soft key to select a function type to assign. In this example a Special function will be assigned.

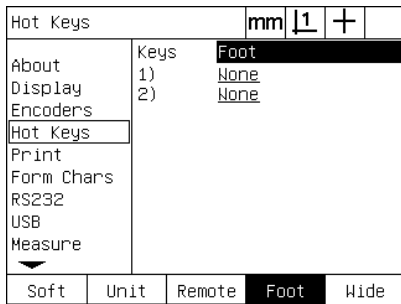

Press a soft key to select a key or switch type

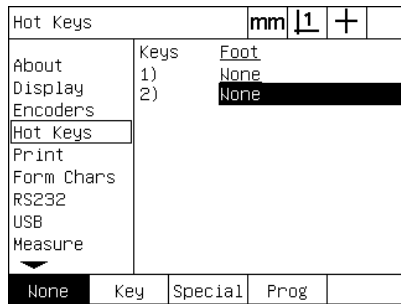

Highlight a specific key or switch for assignment

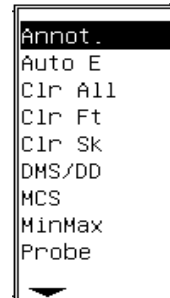

Press a soft key to select a function type

- ▶ Highlight the specific function and press the ENTER key to complete the assignment. In this example the Auto E (Auto edge detection) function is assigned to foot switch 2. After the assignment, pressing foot switch 2 will toggle the edge detection between manual and automatic.

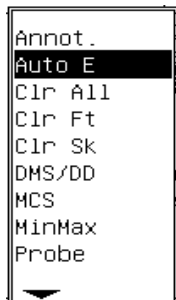

Highlight a specific function to assign

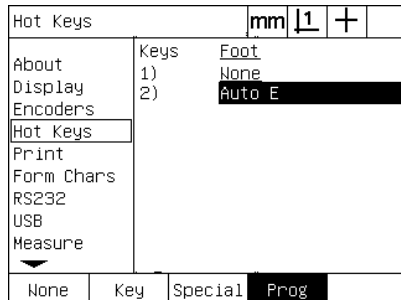

Press the ENTER key to complete the assignment

- ▶ Press the FINISH key to return to the setup menu.

The functions contained in the Special menu are shown here:



The selection of a language can be assigned to a hot key. Individual languages appear in the Special menu but are not shown separately in this list of hot key functions.

Special menu function	Description
Annot	Toggles between forward and backward annotation probing
Auto E	Toggles between manual and automatic edge detection probing
Clr All	Clears the feature list, skews and datums
Clr Ft	Clears features from the features list
Clr Sk	Clears the skew part alignments and datums
DMS/DD	Toggles the display of angles between degrees, minutes and seconds and decimal degrees.
MCS	Clears datums and reestablishes machine coordinates.
MinMax	Displays the maximum and minimum encoder count on the selected axis. An absolute range (from the minimum to maximum) is displayed as well.
Probe	Toggles the probe selection between crosshairs and (optional) optical edge detection.
Preset	Presets datums to user specified values that correspond to known part coordinates such as dimensions specified by a part drawing.
Preset!	Repeats the last preset datum performed.
Prog	Displays a list of prerecorded programs for selection by the user.
Prt RS	Sends data for the current print request to the RS-232 serial port
Prt USB	Sends data for the current print request to the USB port
Run!	Runs the last program again.
Send 2, 3, 4	Sends the current X-Y, X-Y-Z or X-Y-Z-Q axes data to a printer or computer.
Send D	Sends the current diameter data to a printer or computer.
Send F	Sends the current form error data to a printer or computer.
Send L	Sends the current length data to a printer or computer.
Send Q	Sends the current protractor Q-axis data to a printer or computer.
Send r	Sends the current radius data to a printer or computer.
Send X	Sends the current X-axis data to a printer or computer.
Send Y	Sends the current Y-axis data to a printer or computer.
Send Z	Sends the current Z-axis data to a printer or computer.
Send <	Sends the current angle measurement data to a printer or computer.

Special menu function	Description
Teach	Initiates an (optional) optical edge calibration
Time	Displays the current time and date
Zero 2	Zeroes the X and Y axes
Zero Q	Zeroes the Q-axis
Languages	Selects a language

- ▶ Highlight the Pre Line, Post Line or Post Form data field and then enter the desired ASCII character. Up to four ASCII key codes can be entered for each data field. For example, Ascii key codes entered in the Pre Line field occur before each line of print on a report, so entering an ASCII key code 32 inserts a space before each line of print. Characters must be separated by a space. ASCII key codes are shown on the next page.
- ▶ Highlight the Auto Label choice field and press the YES soft key to include descriptive labels with the printed data.

Print		mm	1	+
About	Report Width	80		
Display	Lines / Page	60		
Encoders	Form Feed	Yes		
Hot Keys	Pre Line			
Print	Post Line	10 13		
Form Chars	Post Form			
RS232	Auto Label	Yes		
USB	Print Edges	Off		
Measure	Print Units	No		
<div style="display: flex; justify-content: space-between;"> No Yes </div>				

Enter pre line, post line or post form ASCII control characters

Print		mm	1	+
About	Report Width	80		
Display	Lines / Page	60		
Encoders	Form Feed	Yes		
Hot Keys	Pre Line			
Print	Post Line	10 13		
Form Chars	Post Form			
RS232	Auto Label	Yes		
USB	Print Edges	Off		
Measure	Print Units	No		
<div style="display: flex; justify-content: space-between;"> No Yes </div>				

Press the YES soft key to specify automatic data labeling

- ▶ Highlight the Print Edges choice field and press the LIST soft key to print a report when an optical edge is detected, select the printing format from the list and then press the ENTER key. Formats include:
 - OFF: No report is printed
 - Standard: Print axis coordinates when edge is crossed
 - Srf2: Print axis coordinates and last coordinates before edge to 2 decimal places
 - Srf3: Print axis coordinates and last coordinates before edge to 3 decimal places

Print		mm	1	+
About	Report Width	80		
Display	Lines / Page	60		
Encoders	Form Feed	Yes		
Hot Keys	Pre Line			
Print	Post Line	10 13		
Form Chars	Post Form			
RS232	Auto Label	Yes		
USB	Print Edges	Off		
Measure	Print Units	No		
<div style="display: flex; justify-content: space-between;"> List </div>				

Press the list soft key to configure reports for detected edges

Off
Standard
Stf2
Stf3

Select a printing format from the list

ASCII codes:

Code	Character	Code	Character	Code	Character	Code	Character	Code	Character
8	Backspace	31	US	54	6	77	M	100	d
9	Horizontal tab	32	Space	55	7	78	N	101	e
10	Line feed	33	!	56	8	79	O	102	f
11	Vertical tab	34	"	57	9	80	P	103	g
12	Form feed	35	#	58	:	81	Q	104	h
13	Carriage return	36	\$	59	;	82	R	105	i
14	SO	37	%	60	<	83	S	106	j
15	SI	38	&	61	=	84	T	107	k
16	DIE	39	'	62	>	85	U	108	l
17	DC1	40	(63	?	86	V	109	m
18	DC2	41)	64	@	87	W	110	n
19	DC3	42	*	65	A	88	X	111	o
20	DC4	43	+	66	B	89	Y	112	p
21	NAK	44	,	67	C	90	Z	113	q
22	SYN	45	-	68	D	91	[114	r
23	ETB	46	.	69	E	92	\	115	s
24	CAN	47	/	70	F	93]	116	t
25	EM	48	0	71	G	94	^	117	u
26	SUB	49	1	72	H	95	_	118	v
27	ESC	50	2	73	I	96	'	119	w
28	FS	51	3	74	J	97	a	120	x
29	GS	52	4	75	K	98	b	121	y
30	RS	53	5	76	L	99	c	122	z

- ▶ Highlight the Print Units choice field and press the YES soft key to include unit of measure labels with the printed data.

Print		mm	1	+
About	Report Width	80		
Display	Lines / Page	60		
Encoders	Form Feed	Yes		
Hot Keys	Pre Line			
Print	Post Line	10 13		
Form Chars	Post Form			
RS232	Auto Label	Yes		
USB	Print Edges	Off		
Measure	Print Units	No		
		No	Yes	

Press the YES soft key to include units of measure

- ▶ Press the finish key to return to the setup menu.

Form chars screen

The Form chars (characters) screen contains printer configuration data fields for including ASCII control strings in front of the report data stream.

Up to 3 ASCII characters can be entered into each data field. Each character must be separated from the next by a space.

To format printing in the Form chars screen:

- ▶ Highlight the Form chars menu item.
- ▶ Highlight the first field and enter the required ASCII control characters.

Form Chars		mm	1	+
About	Pre Form			
Display				
Encoders				
Hot Keys				
Print				
Form Chars				
RS232				
USB				
Measure				

Enter Pre form ASCII control characters

- ▶ Continue highlighting fields and entering characters until the data stream is complete.
- ▶ Press the FINISH key to return to the setup menu.

RS-232 port configuration

The RS232 screen contains data and choice fields for configuring communication parameters of the RS-232 serial port.

RS232 screen

The RS232 screen configuration fields include:

- Baud rate
- Word length
- Stop bits
- Parity
- Type of data sent on the serial port
- End of character and end of line delay

To configure the RS-232 port:

- ▶ Press MENU/SETUP to display the setup menu and then highlight the RS232 menu item.
- ▶ Highlight the Baud choice field and then press a soft key to increase (INC) or decrease (DEC) the baud rate.
- ▶ Highlight the Word Len choice field and press a soft key to select a 7 or 8 bit word length.
- ▶ Highlight the Stop Bits choice field and press a soft key to select 1 or 2 stop bits.

RS232		mm	↓	1	+
About	Baud	115200			
Display	Word Len	8			
Encoders	Stop Bits	1			
Hot Keys	Parity	None			
Print	Handshake	Hard.			
Form Chars	Data	None			
RS232	EOL Delay	0			
USB	EOL Delay	0			
Measure					
Dec	Inc				

Press the DEC or INC soft key to decrease or increase the baud rate

RS232		mm	↓	1	+
About	Baud	115200			
Display	Word Len	8			
Encoders	Stop Bits	1			
Hot Keys	Parity	None			
Print	Handshake	Hard.			
Form Chars	Data	None			
RS232	EOL Delay	0			
USB	EOL Delay	0			
Measure					
7	8				

Press a soft key to select a 7 or 8 bit word length

RS232		mm	↓	1	+
About	Baud	115200			
Display	Word Len	8			
Encoders	Stop Bits	1			
Hot Keys	Parity	None			
Print	Handshake	Hard.			
Form Chars	Data	None			
RS232	EOL Delay	0			
USB	EOL Delay	0			
Measure					
1	2				

Press a soft key to select 1 or 2 stop bits

- ▶ Highlight the Parity choice field and press a soft key to select ODD, EVEN or NONE.
- ▶ Highlight the Data choice field and press the LIST soft key to display the data choices for communication on the RS-232 port.
- ▶ Highlight the data choice and press the ENTER key to select the data. Data choices include:
 - None: No data will be sent
 - Display: Contents of the current display
 - Report: All feature measurement data without tolerance results
 - Tol Rpt: All tolerance data without feature measurement results
 - CSV: All feature measurement data without tolerance results in comma separated variable format
 - Tab: All feature measurement data without tolerance results in tab separated variable format

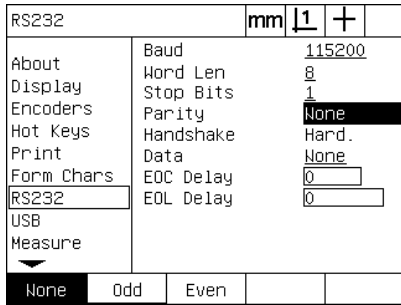

Press the ODD or EVEN soft key to select parity

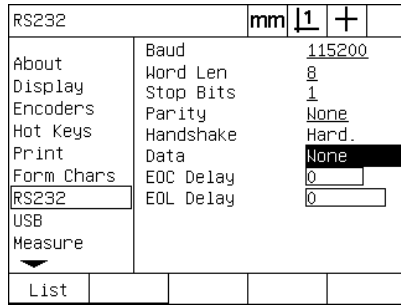

Press the LIST soft key to display data choices

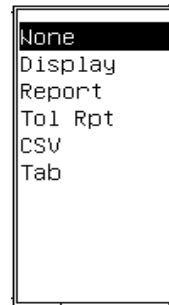

Highlight a data selection and press the ENTER key

- ▶ Highlight the EOC (end of character) Delay and EOL (end of line) Delay data fields and enter any delays in milliseconds that might be required to optimize RS-232 communication negotiations with external devices.

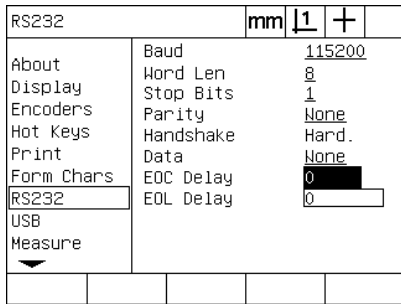

Enter an EOC or EOL delay

- ▶ Press the FINISH key to return to the setup menu.

USB port configuration

The USB port can send data to a flash drive on the USB port or to a USB printer. The USB screen contains data and choice fields for configuring communication parameters of the USB port.

USB screen

The USB screen configuration fields include:

- Type of data sent on the USB port
- Destination of the data; USB flash drive file or printer
- File handling: replace file, append to existing file or create new autonumbered file
- Current file number for autonumbering files
- User prompting for file type

To configure the USB port:

- ▶ Press MENU/SETUP to display the setup menu and then highlight the USB menu item.
- ▶ Highlight the Data choice field and then press the LIST soft key to display data type choices.
- ▶ Highlight a data type choice field and press the ENTER key to select it. Data type choices include:
 - None: No data will be sent
 - Display: Contents of the current display
 - Report: All feature measurement data without tolerance results
 - Tol Rpt: All tolerance data without feature measurement results
 - CSV: All feature measurement data without tolerance results in comma separated variable format
 - Tab: All feature measurement data without tolerance results in tab separated variable format

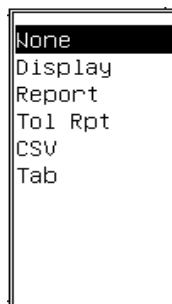
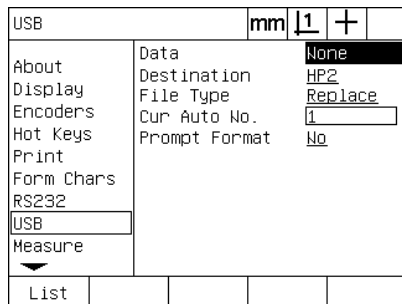

Press the LIST soft key to display a list of data types

Highlight a data type and press the ENTER key to select it

- ▶ Press the FINISH key to return to the setup menu.

- ▶ Highlight the Destination choice field and press the HP2 soft key to select a printer or the FILE soft key to send data to a file on the USB drive.
- ▶ Highlight the File Type choice field and press a soft key to select one of the following file types:
 - Replace: The existing file is replaced each time a file is sent
 - Append: The existing file is extended to include the new data
 - AutoNo: A new file is created each time data is sent. The new file is automatically given the next number in a sequence that begins with the number specified in the Cur Auto No data field.
- ▶ Highlight the Cur Auto No data field and enter the first file number in a sequence of automatically numbered files.

USB		mm	1	+
About	Data	None		
Display	Destination	HP2		
Encoders	File Type	Replace		
Hot Keys	Cur Auto No.	1		
Print	Prompt Format	No		
Form Chars				
RS232				
USB				
Measure				
File	HP2			

Press a soft key to select the data destination

USB		mm	1	+
About	Data	None		
Display	Destination	HP2		
Encoders	File Type	Replace		
Hot Keys	Cur Auto No.	1		
Print	Prompt Format	No		
Form Chars				
RS232				
USB				
Measure				
Replace	Append	AutoNo.		

Press a soft key to select a file type

USB		mm	1	+
About	Data	None		
Display	Destination	HP2		
Encoders	File Type	Replace		
Hot Keys	Cur Auto No.	1		
Print	Prompt Format	No		
Form Chars				
RS232				
USB				
Measure				

Enter the current first file number for automatic numbering

- ▶ Highlight the Prompt choice field and press the YES soft key to prompt the user for a data type. Press the NO soft key to send the file using the data type specified in the Data field.

USB		mm	1	+
About	Data	None		
Display	Destination	HP2		
Encoders	File Type	Replace		
Hot Keys	Cur Auto No.	1		
Print	Prompt Format	No		
Form Chars				
RS232				
USB				
Measure				
No	Yes			

Press the YES soft key to prompt the user for data type

- ▶ Press the FINISH key to return to the setup menu.

Audio configuration

The ND 1200 can be configured to generate a sound in response to certain measurement activities and results.

Sounds screen

The Sounds screen contains choice fields for enabling or disabling audio beeps in response to:

- Warning: Any warning shown on the screen
- Point entry: When a point is entered during measurement
- Begin measure: Immediately prior to a measurement during a program execution
- Good result: When a measurement passes all tolerance tests
- Failed result: When a measurement fails a tolerance test
- Excess form: Form error in excess of factory default values. These values cannot be changed and represent extreme form errors. This function is intended as a precautionary alert.

All audio responses are alerts and are enabled using the same method. To enable an audio alert:

- ▶ Press MENU/SETUP to display the setup menu and then highlight the Sounds menu item.
- ▶ Highlight the desired audio alert choice field and then press the SIMPLE soft key to enable the alert or press the NONE soft key to disable it.

The volume of all audio responses can be changed simultaneously from silence to loud. To adjust the volume of all audio alerts:

- ▶ Highlight the Volume data field and enter a value from 0 to 10. A value of 0 will silence alerts. Alert volume increases from 1 to 10.

Sounds		mm	1	+
Display	Warning		Simple	
Encoders	Point Entry		Simple	
Hot Keys	Begin Measure		None	
Print	Good Result		None	
Form Chars	Failed Result		None	
RS232	Excess Form		None	
USB	Volume		10	
Measure				
Sounds				
None		Simple		

Highlight the desired alert choice field and Press the SIMPLE soft key to enable the alert.

Sounds		mm	1	+
Display	Warning		Simple	
Encoders	Point Entry		Simple	
Hot Keys	Begin Measure		None	
Print	Good Result		None	
Form Chars	Failed Result		None	
RS232	Excess Form		None	
USB	Volume		10	
Measure				
Sounds				

Highlight the Volume data field and enter a value to adjust the loudness of all alerts

- ▶ Press the FINISH key to return to the setup menu.

Key repeat rate adjustment

When a front panel key is pressed and held, the function repeats. The auto-repeat rate for front panel keys can be adjusted.

Misc screen

The Misc screen contains a data field for adjusting key repeat rate. To adjust the key repeat rate:

- ▶ Press MENU/SETUP to display the setup menu and then highlight the Misc menu item.
- ▶ Highlight the Key Delay data field and enter a value between 5 and 25. Enter small values for fast repetition or large values for slow repetition.



Values smaller than 5 and larger than 25 can make the keyboard difficult to use and should be avoided.

Misc.		mm	1	+
▲	Key Delay		5	
Measure	Auto Dro Cnts		20	
Sounds	X External 0		No	
Supervisor	Y External 0		No	
Squareness	Z External 0		No	
LEC	Q External 0		No	
SLEC	OE Timeout (ms)		100	
NLEC	OE Debounce (ms)		500	
Scale Factor				
Misc.				
▼	Slew Limit		50000	

Enter a value to adjust key repeat rate

- ▶ Press the FINISH key to return to the setup menu.

Time and date settings

The time and date appear in data, on reports and can be displayed on the screen through the Extra menu.

Clock screen

The Clock screen contains data fields for setting the time and date. To set the time and date:

- ▶ Press MENU/SETUP to display the setup menu and then highlight the Clock menu item.
- ▶ The date and time are set using the same method: Highlight a date or time data field and enter the value.
- ▶ Highlight the Date Format choice field and press a soft key to select the desired format.
- ▶ Highlight the Time Format and press a soft key to select the 12 hour or 24 hour time format.

Clock		mm	↓1	+
↑	Year	0		
Sounds	Month	0		
Supervisor	Day	0		
Squareness	Hours	0		
LEC	Minutes	0		
SLEC	Seconds	0		
NLEC	Date Format	M/D/Y		
Scale Factor	Time Format	12		
Misc.				
↓	Clock			

Enter date and time values

Clock		mm	↓1	+
↑	Year	0		
Sounds	Month	0		
Supervisor	Day	0		
Squareness	Hours	0		
LEC	Minutes	0		
SLEC	Seconds	0		
NLEC	Date Format	M/D/Y		
Scale Factor	Time Format	12		
Misc.				
↓	Clock			
	M/D/Y	D/M/Y		

Select a date format

Clock		mm	↓1	+
↑	Year	0		
Sounds	Month	0		
Supervisor	Day	0		
Squareness	Hours	0		
LEC	Minutes	0		
SLEC	Seconds	0		
NLEC	Date Format	M/D/Y		
Scale Factor	Time Format	12		
Misc.				
↓	Clock			
	12	24		

Select a time format

- ▶ Press the FINISH key to return to the setup menu.

Saving settings files and programs

The Supervisor screen contains tools for saving ND 1200 configuration settings files which include any ND 1200 programs and error correction data. Settings files are saved to the root of a USB drive.



Settings files should be saved any time configuration changes are made, error correction data is collected or programs are created or modified.

To save settings files:

- ▶ Insert a USB drive into the USB port.
- ▶ Press MENU/SETUP to display the setup menu and then highlight the Supervisor menu item.
- ▶ Highlight the Password data field and enter the password.
- ▶ To save the configuration parameters (settings.bin file): press the SAVE soft key, then follow the instructions displayed on the screen.

Supervisor	mm	1	+	
▲	Password	xxxxxx		
Supervisor	Programs	Lock		
Squareness				
LEC				
SLEC				
NLEC				
Scale Factor				
Misc.				
Clock				
▼				
Load...	Save...	Startup		

Enter the Supervisor password

- ▶ Press the FINISH key to save parameters and return to the setup menu.

2.4 Specifications

Specifications	
Axes	2 to 4 axes
Encoder inputs	<ul style="list-style-type: none"> ■ Linear and rotary encoders <ul style="list-style-type: none"> ■ Analog 1 V_{PP} ■ TTL
Display	Black and white LCD <ul style="list-style-type: none"> ■ 5.7" (14.48 cm) ■ 0.50" (1.27 cm) display digit size ■ 0.000004" (0.00001 mm) Resolution
Error compensation	Linear (LEC), segmented linear (SLEC, Nonlinear (NLEC)
Data interfaces	Serial interfaces <ul style="list-style-type: none"> ■ RS-232-C ■ USB 2.0 Type A Full-speed
Optional accessories	<ul style="list-style-type: none"> ■ Remote foot switch ■ Remote keypad ■ Optical edge detector cables and cable holder ■ ND 1200 Protective cover ■ QC-Wedge communication software
Main power input	100 Vac to 240 Vac; 50 to 60 Hz
Line fuse	1.6 Amp, 250 V slow blow; 5 X 20 mm
ENC testing	<ul style="list-style-type: none"> ■ EN61326: 1998 EMC for electrical equipment for measurement, control and laboratory use ■ EN61010: Safety requirements for electrical equipment for measurement, control and laboratory use
Installation category	II
Environmental	<ul style="list-style-type: none"> ■ Temperature: 32 °F to 113 °F (0 °C to 45 °C) non-condensing ■ Relative air humidity: 90% ■ Altitude: 6562 feet (2000 meters)
Enclosure	Benchtop; cast-metal enclosure
Dimensions	<ul style="list-style-type: none"> ■ Enclosure (W x H x D): 11.5" X 7.5" X 2.75" (29.21cm X 19.05 cm X 6.99 cm) ■ Base (W x H x D): 10" X 2" X 7.8" (25.4 cm X 5.8 cm X 19.81 cm)
Weight	<ul style="list-style-type: none"> ■ Enclosure: 3.5 lbs (1.6 kg) ■ Base: 7 lbs (3.2 kg)

Dimensions

The ND 1200 enclosure, tray stand and arm mount bracket dimensions are shown in the format: mm.

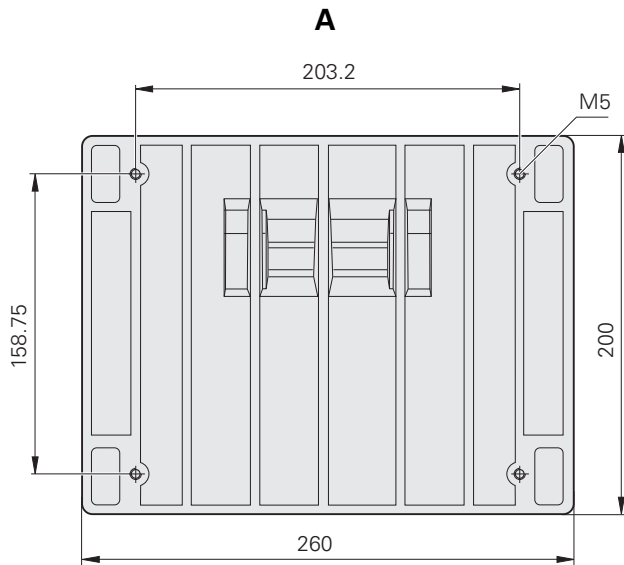
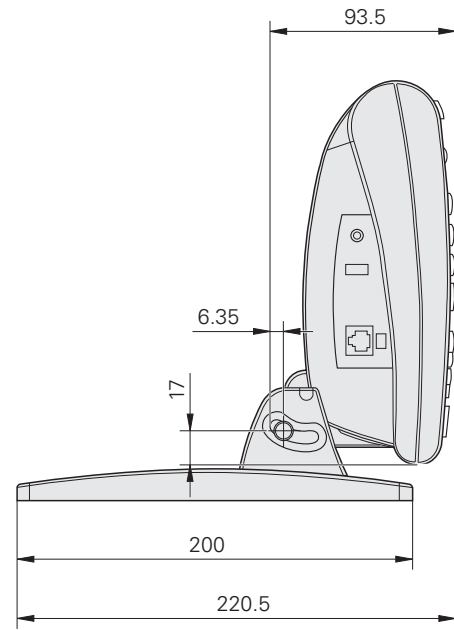
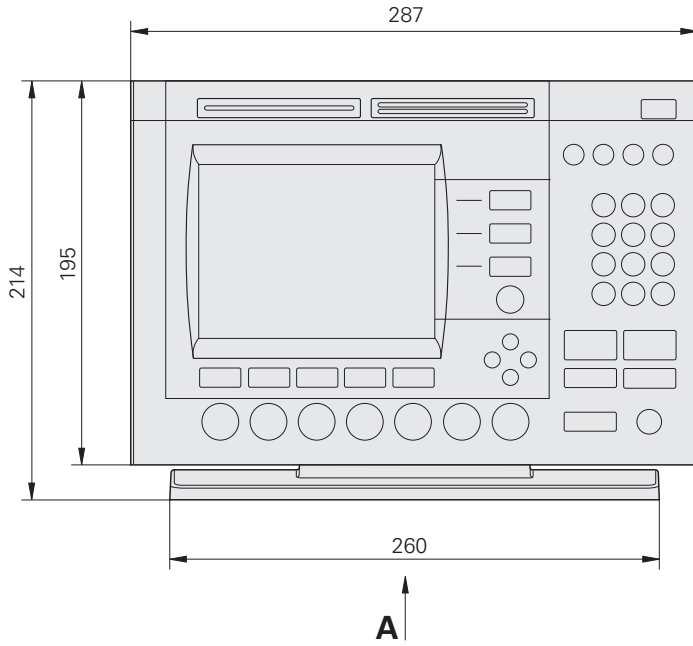

2.4 Specifications

Arm mount bracket

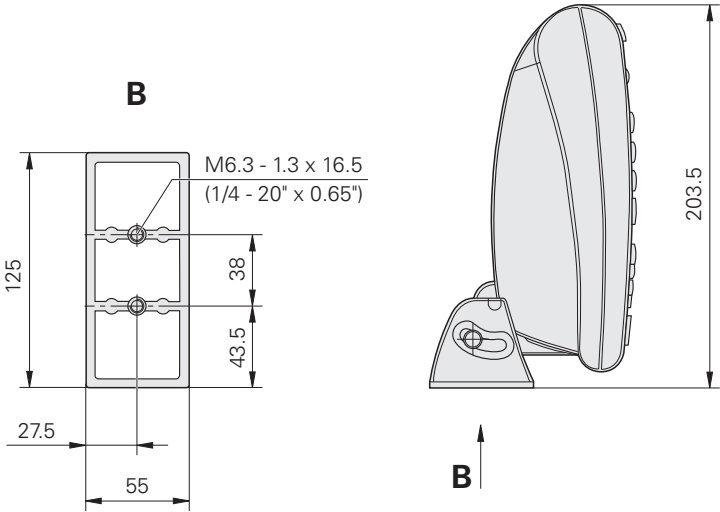

NUMERICS

- 2-wire power plug adapters ... 7
- 3-wire grounded outlet ... 7

A

- About screen ... 89
- Accessories ... 134
- Alignment of parts ... 34
- Angle types ... 46
 - 180+A1 ... 46
 - 180-A1 ... 46
 - 360-A1 ... 46
 - INCLD ... 46
- Annotation ... 31, 112
 - Backward ... 31
 - Forward ... 31
- Arrow cursor keys ... 4, 21
- ASCII codes ... 124
- ASCII control strings ... 125
- Audio alerts ... 82, 130
- Auto DRO counts ... 95
- Axis ... 134
- Axis encoder connectors ... 81
- Axis keys ... 3, 19
 - Preset an axis ... 19
 - Zero an axis ... 19
- Axis selection ... 92

B

- Baud rate ... 126

C

- Circle fit algorithms ... 44
 - Inner ... 44
 - ISO ... 44
 - LSBF ... 44
 - Outer ... 44
- Cleaning ... 7
- Clock screen ... 132
- Command keys ... 3, 19
 - Cancel ... 19
 - Enter ... 19
 - Finish ... 19
 - Quit ... 19

- Comparator screen ... 84
- Computer ... 82
- Constructing part features ... 49
 - Example ... 50
 - More examples ... 51
 - Parent features ... 49, 51
- Coordinate system selection ... 30
- Creating Part Features
 - Example ... 48
- Creating part features ... 47
 - Parent features ... 47

D

- Data interfaces ... 134
- Data sent on the serial port ... 126
- Data sent on the USB port ... 128
- Date ... 132
- Datum
 - Constructing ... 35
 - Establishing ... 35
 - Preset ... 35, 37
 - Zero ... 35, 36
- Datum selection ... 30
- Dimensions ... 134, 135
- Display screen ... 115
 - Comma or decimal radix ... 115
 - Display resolution ... 115
 - Startup units of measure ... 115
- Distance
 - Absolute value ... 112
 - Signed value ... 112

E

- Edge menu ... 96
- ENC testing ... 134
- Encoder count direction ... 92
- Encoder inputs ... 134
- Encoder reference mark crossings ... 17
- Encoder resolution ... 92
- Encoder type ... 92
- Encoders ... 81
- Encoders screen ... 92
- End of character delay ... 126
- End of line delay ... 126
- Environmental ... 134
- Error compensation ... 134

- Error correction ... 29
 - Linear error correction (LEC) ... 99, 100
 - NLEC by importing an nlec.txt file ... 110
 - NLEC by measuring points ... 108
 - NLEC.txt file ... 106, 110
 - Nonlinear error correction (NLEC) ... 99, 106
 - Observed values ... 103
 - Segmented linear error correction (SLEC) ... 99, 102
 - Standard values ... 103
 - Station numbers ... 103
 - Teach soft key ... 105
- Error indications ... 73
 - Scale errors ... 73
- External axis-zero enable ... 95

F

- Fast track keys ... 4, 20
 - Left wide key ... 20
 - Right wide key ... 20
- Feature list ... 38
- Feature tolerances
 - Angle ... 54
 - Bidirectional position ... 54
 - Concentricity ... 54
 - LMC ... 54
 - MMC ... 54
 - Parallelism ... 54
 - Perpendicularity ... 54
 - Roundness ... 54
 - Runout ... 54
 - Straightness ... 54
 - True position ... 54
 - Width ... 54
- Foot switch ... 83
- Form chars screen ... 125
- Form feed ... 122
- Front panel keys ... 3
- Fuse ... 134

- H**
 Hard-stop axis reference position ... 17
 Hardware installation ... 78
 Arm mounting ... 79
 Connecting a computer ... 82
 Connecting a headphone ... 82
 Connecting a USB printer ... 82
 Connecting an optional foot switch,
 hand switch or remote
 keypad ... 83
 Connecting and installing optical
 edge detection ... 84
 Connecting power ... 80, 81
 Mounting stand ... 78
 Headphone ... 82
 Hot keys screen ... 118
- I**
 Installation category ... 134
- K**
 Key presses ... 6
- L**
 LCD ... 134
 LCD on/off key ... 4, 20
 LCD screen ... 3, 22
 Contrast adjustment ... 30
 DRO mode ... 22
 Feature evaluation mode ... 22
 Feature measurement mode ... 22
 Setup mode ... 22
 LEC screen ... 101
 Line fit algorithms ... 43
 ISO ... 43
 LSBF ... 43
 Linear error correction (LEC) ... 100
- M**
 Machine zero ... 17, 29, 92
 Machine zero upon startup ... 112
 Measure keys ... 3, 18
 Angle ... 18
 Circle ... 18
 Distance ... 18
 Line ... 18
 Measure Magic ... 18
 Point ... 18
 Skew alignment ... 18
- Measure screen ... 112
 Measuring part features ... 38
 Angles ... 46
 Auto repeat ... 41
 Circles ... 44
 Distances ... 45
 Lines ... 43
 Points ... 42
 Menu key ... 4, 20
 Clear ... 20
 Edge ... 20
 Extra ... 20
 Prog ... 20
 Setup ... 20
 Menus ... 25
 Clear ... 27
 Clr All ... 28
 Clr Ft ... 28
 Clr Sk ... 28
 Edge menu
 ... 28
 Auto E ... 28
 D. Cal ... 28
 Install ... 28
 Teach ... 28
 X Cal ... 28
 Extra ... 26
 Annot ... 26
 DMS/DD ... 26
 MCS ... 26
 MinMax ... 26
 Preset ... 26
 Preset! ... 26
 Prt RS ... 26
 Run ... 26
 Send ... 27
 Send 2 ... 26
 Send 3 ... 26
 Send 4 ... 26
 Send D ... 26
 Send F ... 27
 Send L ... 27
 Send Q ... 27
 Send r ... 27
 Send X ... 27
 Send Y ... 27
 Send Z ... 27
 Time ... 27
 Zero 2 ... 27
 Zero Q ... 27
- Prog ... 25
 Copy ... 25
 Delete ... 25
 Edit ... 25
 Record ... 25
 Run ... 25
 Setup ... 25
 Misc screen ... 95, 97, 131
 Mode keys ... 3, 19
 Select a datum ... 19
 Select coordinate system ... 19
 Unit of measure ... 19
 Mounting arm bracket ... 79
 Mounting stand ... 78
 MZ Cnts ... 92
- N**
 NLEEC screen ... 107
 NLEEC.txt file ... 106
 Nonlinear error correction
 (NLEEC) ... 106
 Numeric keypad ... 4
- O**
 Observed values ... 103
 Optical edge (OE) debounce ... 97
 Optical edge (OE) time-out ... 97
 Optical edge detection ... 84
 Probing target size ... 112
 Reference cable input ... 84
 Sensor cable input ... 84
 Optical edge detector calibration ... 33
 D. Cal ... 33
 Teach ... 33
 X Cal ... 33
 Overview ... 14
- P**
 Parity ... 126
 Part alignment ... 34
 Power ... 80
 3-wire power plug ... 80
 Fuse ... 80
 Surge suppressors ... 80
 Power input ... 134
 Power plug ... 7
 Power switch ... 16, 29, 80
 Print screen ... 122
 Printer ... 82
 Printer control characters ... 122

- Probe type ... 32
 - Crosshairs ... 32
 - Optical edge ... 32
 - Manual and automatic point entry ... 32
- Probing part features ... 39
 - Crosshairs ... 39
 - Edge detection ... 39
 - Measure Magic ... 40
- Programming ... 58
 - Backing up programs ... 71
 - Copying a program ... 69
 - Deleting a program ... 70
 - Editing a program ... 62
 - Changing a program step ... 64
 - Deleting a program step ... 67
 - Displaying program steps ... 62
 - Expanding and compressing a program steps ... 63
 - Inserting new program steps ... 68
 - Example of recording a program ... 59
 - Example of running a program ... 61
 - Pause on tolerance failure ... 112
 - Recording a program ... 58
 - Running a program ... 60
- R**
 - Rear panel ... 5
 - Reference mark selection ... 92
 - Reference marks ... 17, 29
 - Reference positions ... 17
 - Remote keypad ... 83
 - Repackaging the QC-200 for shipment ... 77
 - Report data labels ... 122
 - Report length ... 122
 - Report width ... 122
 - Reports ... 72
 - Report types ... 72
 - CSV ... 72
 - Display ... 72
 - None ... 72
 - Report ... 72
 - Tab ... 72
 - Tol Rpt ... 72
 - Sending reports ... 72
 - Reversing encoder count direction ... 92
 - RJ-45 connector ... 83
 - RJ-45 splitter ... 83
 - RS232 screen ... 126
 - RS-232 serial port ... 82
 - Baud rate ... 82
 - Parity ... 82
 - Serial cable ... 82
 - Stop bits ... 82
 - Word length ... 82
- S**
 - Safety ... 7
 - Scale factor ... 111
 - Scale Factor screen ... 111
 - Segmented linear error correction (SLEC) ... 102
 - Send key ... 4, 20
 - Settings files ... 133
 - Setup menu ... 86
 - Shipment contents ... 76
 - Side panel ... 5
 - Skew alignment ... 34
 - Slew limit for the axes ... 95
 - Soft keys ... 3, 22
 - Change ... 23
 - Const ... 24
 - Create ... 24
 - Probe ... 22
 - Recall ... 23
 - Tol ... 23
 - View ... 23
 - Zoom ... 23
 - Software setup ... 85
 - Audio configuration ... 130
 - Display formatting ... 115
 - Encoder configuration ... 92
 - Error correction ... 99
 - Example of entering the supervisor password ... 87
 - Hot key assignments ... 118
 - Key repeat rate adjustment ... 131
 - Language selection ... 89
 - Loading settings files and startup screens ... 91
 - Measurement configuration ... 112
 - Measurement scaling for parts that expand or shrink ... 111
 - Optical edge detection ... 96
 - Order of setup ... 88
 - Print formatting ... 122
 - Program unlocking ... 90
 - RS-232 port configuration ... 126
 - Saving settings files and programs ... 133
 - Stage squareness calibration ... 98
 - Supervisor password ... 90
 - Time and date settings ... 132
 - USB port configuration ... 128
 - Software version ... 7
 - Sounds screen ... 130
 - Speaker jack ... 82
 - Specifications ... 134
 - Squareness screen ... 98
 - Standard values ... 103
 - Startup machine zero ... 112
 - Station numbers ... 103
 - Stop bits ... 126
 - Supervisor password ... 87
 - Supervisor screen ... 90, 133
 - Symbols ... 6

T

Teach soft key ... 105

Time ... 132

Tolerancing ... 54

 Applying tolerances ... 55

 Example ... 56

 Feature tolerances ... 54

 Print report based on tolerance
 result ... 112

U

Unit of measure selection ... 30

Units of measure ... 92

USB flash drive ... 128

USB printer ... 82

USB screen ... 128

V

Version of software and hardware ... 89

W

Warning shown on the screen ... 130

Weight ... 134

Word length ... 126

HEIDENHAIN

DR. JOHANNES HEIDENHAIN GmbH

Dr.-Johannes-Heidenhain-Straße 5

83301 Traunreut, Germany

☎ +49 (8669) 31-0

☎ +49 (8669) 5061

E-mail: info@heidenhain.de

Technical support ☎ +49 (8669) 32-1000

Measuring systems ☎ +49 (8669) 31-3104

E-mail: service.ms-support@heidenhain.de

TNC support ☎ +49 (8669) 31-3101

E-mail: service.nc-support@heidenhain.de

NC programming ☎ +49 (8669) 31-3103

E-mail: service.nc-pgm@heidenhain.de

PLC programming ☎ +49 (8669) 31-3102

E-mail: service.plc@heidenhain.de

Lathe controls ☎ +49 (8669) 31-3105

E-mail: service.lathe-support@heidenhain.de

www.heidenhain.de

