



HEIDENHAIN



Product Information

EIB 3011
EIB 3091 F
EIB 3091 M

Signal Converters in
Cable Design

EIB 3001

- Signal converters in a D-sub connector housing
- Integrated 16 384-fold subdivision
- Input: Incremental encoders from HEIDENHAIN
- Output: EnDat 2.2, Fanuc Serial Interface or Mitsubishi high speed interface

mm

 Tolerancing ISO 8015
 ISO 2768:1989 - mH
 ≤ 6 mm: ±0.2 mm

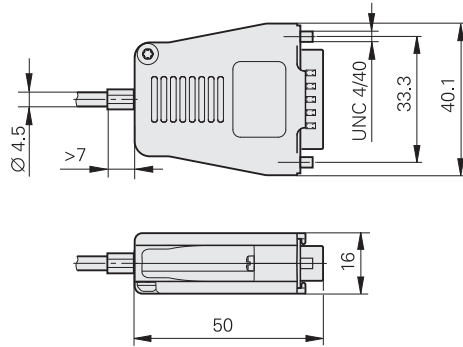

Specifications	EIB 3011	EIB 3091 F	EIB 3091 M
Input	For HEIDENHAIN encoders		
Incremental signals	~ 1 V _{PP} (input frequency: ≤ 400 kHz)		
Reference mark	One or distance-coded		
Electrical connection*	15-pin, 2-row D-sub connector (female), with locking nuts 12-pin M23 connector (female)		
Supply voltage of encoder	DC 5.2 V ±0.25 V		
Cable length	≤ 6 m		
Output			
Interface	EnDat 2.2	Fanuc Serial Interface	Mitsubishi high speed interface
Ordering designation	EnDat22	Fanuc02	Mit03-4
Calculation time t_{cal} Clock frequency	≤ 5 μs ≤ 16 MHz	–	–
Electrical connection	15-pin, 2-row D-sub connector (male) with locking screws and integrated electronics		
Cable length (with HEIDENHAIN cable) ¹⁾	≤ 100 m	≤ 20 m ²⁾	≤ 20 m ²⁾
Subdivision	≤ 16384-fold (depending on encoder)		
Supply voltage	3.6 V to 14 V		
Power consumption (maximum)	3.6 V: 1700 mW (including I _{Mmax} = 150 mA) 14 V: 1700 mW (including I _{Mmax} = 150 mA)		
Current consumption (typical, without load)	At 5 V: 75 mA + 1.3 · I _{Mtyp}		
Operating temperature Storage temperature	0 °C to +70 °C –30 °C to +70 °C		
Vibration 55 Hz to 2000 Hz Shock 11 ms	100 m/s ² (EN 60068-2-6) 200 m/s ² (EN 60068-2-27)		
Protection EN 60529	IP40		
Mass	≈ 0.075 kg (without cable, with electronics)		

* Please indicate when ordering







¹⁾ Comply with the supply voltage at the EIB; I_{Encoder} ≤ 150 mA

²⁾ Greater cable lengths upon request

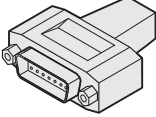
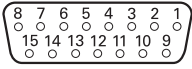
Electrical connection

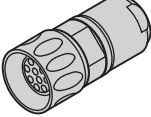
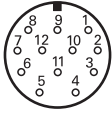
Pin layout: EIB

Input



15-pin D-sub connector					12-pin M23 connector								
													
	Power supply				Incremental signals						Other signals		
	12	2	10	11	5	6	8	1	3	4	/	7	9
	4	12	2	10	1	9	3	11	14	7	5/13/15	8	6
	U_P	Sensor U_P	0V	Sensor 0V	A+	A-	B+	B-	R+	R-	Vacant	H/L1 ¹⁾	L/L2 ¹⁾
	Brown/ Green	Blue	White/ Green	White	Brown	Green	Gray	Pink	Red	Black	/	Violet	Yellow

Shield on housing; U_P = Power supply voltage

Sensor: The sense line is connected internally to the respective power line.

¹⁾ Homing or limit signals (depending on the encoder)

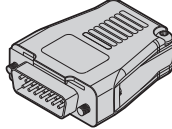
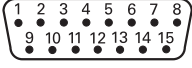
Output

15-pin D-sub connector														
														
	Power supply				Incremental signals						Serial data transfer			
	4	12	2	10	1	9	3	11	14	7	5	13	8	15
EIB 3011	U_P	Sensor U_P	0V	Sensor 0V	/	/	/	/	/	/	DATA	$\overline{\text{DATA}}$	CLOCK	$\overline{\text{CLOCK}}$
EIB 3091F	U_P	Sensor U_P	0V	Sensor 0V	/	/	/	/	/	/	Serial Data	$\overline{\text{Serial Data}}$	Request	$\overline{\text{Request}}$
EIB 3091M	U_P	Sensor U_P	0V	Sensor 0V	/	/	/	/	/	/	Serial Data	$\overline{\text{Serial Data}}$	Request Frame	$\overline{\text{Request Frame}}$

Shield on housing; U_P = Power supply voltage

Sensor: The sense line is connected internally to the respective the power line.

Vacant pins or wires must not be used!

Configuration of the EIB 3001

In order for the EIB 3001 to operate correctly with the encoder, certain encoder parameters must be stored in the EIB 3001 (e.g., the number of signal periods, nominal increment of the reference marks, encoder ID). This programming can be done only by HEIDENHAIN. This information is also printed on the ID label and can be read via the EnDat interface.

Information on the ID label

The **data interface** designates the type of interface for transmission of the position values at the output of the EIB.

Line count or signal period

For rotatory encoders, the signal period is expressed in the number of signal periods per revolution. For linear encoders, the signal period is shown in μm .

The **Encoder ID** states the type of connectable encoder. For example, in the case of EnDat:

- 00 Incremental linear encoder without distance-coded reference marks
 - 10 Incremental linear encoder with distance-coded reference marks
 - 80 Incremental rotary or angle encoder without distance-coded reference marks
 - 90 Incremental rotary or angle encoder with distance-coded reference marks
- For the EnDat interface, this value is stored in word 14 of the EnDat 2.1 parameters.

The **nominal increment N of the reference marks** is indicated in signal periods if the connected encoder has distance-coded reference marks (EnDat 2.2 encoder ID = 10 or 90)

Example:

Information on the ID label for the connection of an ERM 280 (line count: 1024) to the EnDat 2.2 interface via an EIB 3001:
Data interface: EnDat22
Encoder ID: 80
Line count or signal period: 1024
Nominal increment of the ref. marks: N/A
Subdivision: 16384

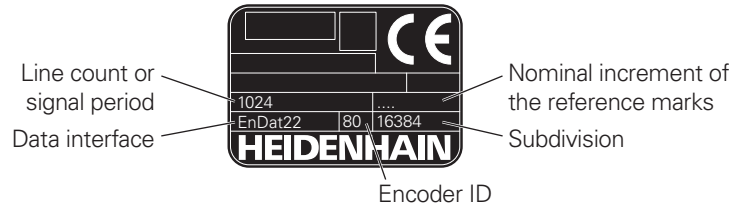

Connection information

Finding the absolute reference

Because incremental encoders are connected to the EIB 3001, the device provides relative position values immediately upon switch-on, starting with the switch-on position. The absolute reference is not established until the reference marks are traversed.

For encoders with distance-coded reference marks, two successive reference marks must be traversed without a change in direction.

EIB 3001: requirements for the control

EnDat 2.2 permanently provides the relative position as Position 1. When the absolute reference is found, the RM bit is set in the EnDat additional data, and the absolute position value is transmitted as Position 2. Before using the EIB 3001, please check whether the subsequent electronics support this EnDat 2.2 device profile for incremental encoders.

Please note:

It is not possible to combine the EIB 3011 and interface electronics with the DRIVE-CLiQ interface (e.g., EIB 2391 S or EIB 3392 S), because these interface electronics accept only absolute encoders.

EIB 3001: encoder mounting and online diagnostics

The encoder is mounted with the help of the testing and inspection devices from HEIDENHAIN, but not with the EIB 3001. After the encoder has been mounted, it can be connected to the EIB 3001 and the downstream electronics.

For checking encoder functionality, the EIB 3001 supports online diagnostics by outputting valuation numbers for the incremental track and a valuation number for the sum evaluation of the reference pulse. This allows the function reserve of the connected encoder to be evaluated.

HEIDENHAIN

DR. JOHANNES HEIDENHAIN GmbH

Dr.-Johannes-Heidenhain-Straße 5

83301 Traunreut, Germany

☎ +49 8669 31-0

FAX +49 8669 32-5061

E-mail: info@heidenhain.de

www.heidenhain.de

This Product Information document supersedes all previous editions, which thereby become invalid. The basis for ordering from HEIDENHAIN is always the Product Information document valid when the contract is made.



Further information:

Comply with the requirements described in the following documents to ensure correct operation of the encoder:

- Brochure: *Interfaces of HEIDENHAIN Encoders* 1078628-xx
- Brochure: *Cables and Connectors* 1206103-xx

For brochures and Product Information documents, visit www.heidenhain.com.