

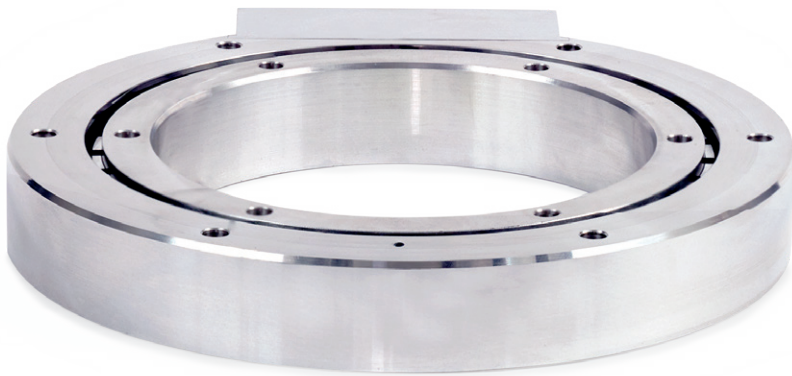

HEIDENHAIN



Product Information

ECI 4010

EBI 4010

Absolute Rotary Encoders
with 90 mm Hollow Shaft

Suitable for Safety-Related
Applications up to SIL 3 with
Additional Measures



ECI 4010, EBI 4010

Rotary encoders for absolute position values with safe singleturn feedback

- Rugged inductive scanning principle
- Hollow through shaft ($\varnothing 90$ mm)
- **EBI 4010: Multiturn functionality through battery-buffered revolution counter**
- Consists of a scanning unit and scale drum

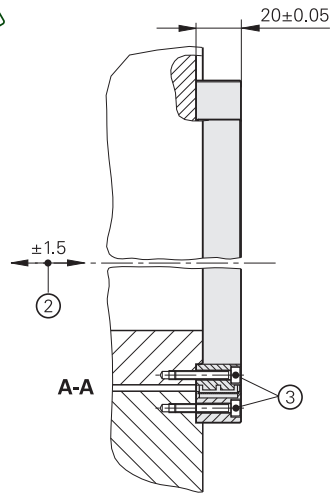
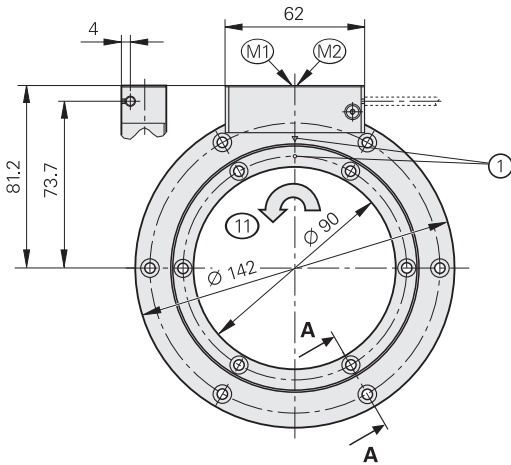
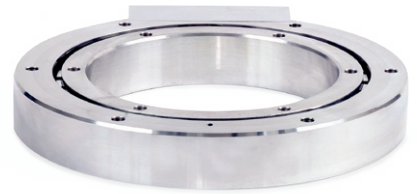

Required mating dimensions

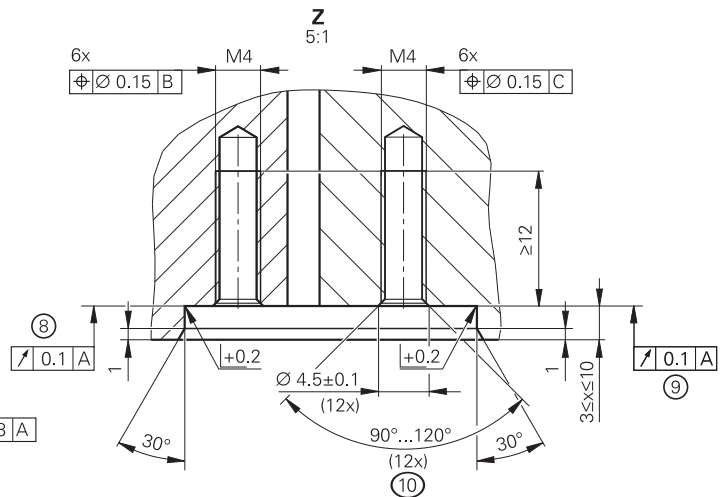
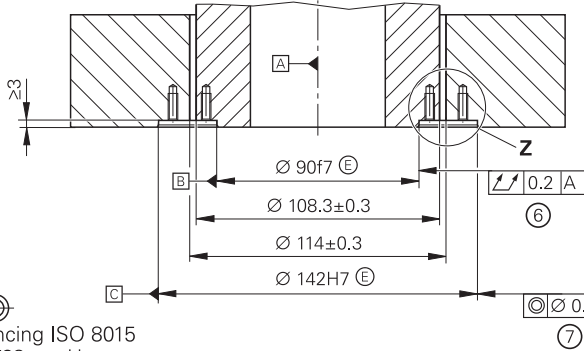
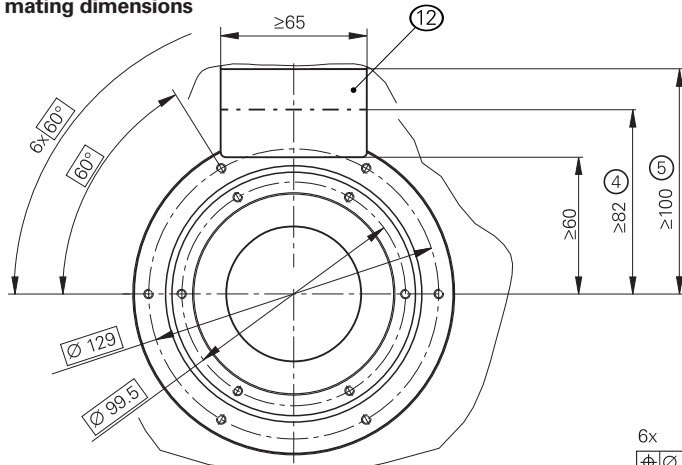

mm

 Tolerancing ISO 8015
 ISO 2768 - m H
 < 6 mm: ±0.2 mm

- ▣ = Bearing of mating shaft
- M1 = Measuring point for operating temperature on housing
- M2 = Measuring point for vibration on housing
- 1 = Position of zero point $\pm 5^\circ$
- 2 = Maximum permissible axial deviation between the shaft surface and flange surface; compensation of mounting tolerances and thermal expansion; dynamic motion permitted over entire range
- 3 = Use screws with material bonding anti-rotation lock: ISO 4762 – M4 x 25 – 8.8 – MKL as per DIN 267-27 (not included in delivery, ID 202264-88); tightening torque: 2.2 Nm ± 0.13 Nm
- 4 = Space required when encoder cover is closed
- 5 = Space required for opening the encoder cover
- 6 = Total runout of mating shaft
- 7 = Coaxiality of stator mating surface
- 8 = Bearing surface of rotor
- 9 = Bearing surface of stator
- 10 = Chamfer at start of thread is obligatory for material bonding anti-rotation lock
- 11 = Direction of shaft rotation for output signals as per the interface description
- 12 = This area of the mating surface does not need to be fully covered by the scanning unit

Specifications	ECI 4010 singletum	EBI 4010 multium
Consisting of	AE ECI4010 scanning unit: ID 1130167-02	AE EBI4010 scanning unit: ID 1130173-02
	TTR EXI4000 scale drum: ID 1130175-02	
Functional safety for applications with up to	As a single-encoder system for monitoring functions and closed-loop functions <ul style="list-style-type: none"> • SIL 2 as per EN 61508 (further basis for testing: IEC 61800-5-3) • Category 3, PL d, according to EN ISO 13849-1:2015 With additional measures as per Document 1000344 for safety-related applications up to SIL 3 or Category 4, PLe Safe in the singleturn range	
PFH	$SIL\ 2: \leq 15 \cdot 10^{-9}$ (probability of dangerous failure per hour) $SIL\ 3: \leq 2 \cdot 10^{-9}$	
Safe position ¹⁾	<i>Encoder</i> : $\pm 0.44^\circ$ (safety-related measuring step: $SM = 0.176^\circ$) Fault exclusion for the loosening of AE scanning unit and TTR scale drum, designed for accelerations at the AE: $\leq 400\ m/s^2$; and at the TTR: $\leq 600\ m/s^2$	
Interface/ordering designation	EnDat 2.2/EnDat22	
Position values per revolution	1 048 576 (20 bits)	
Revolutions	–	65 536 (16 bits)
Calculation time t_{cal} /clock frequency	$\leq 5\ \mu s / \leq 16\ MHz$	
Analog delay time t_{AD} (typical)	13.9 μs	
System accuracy	$\pm 25''$	
Electrical connection	15-pin PCB connector (with connection for external temperature sensor ²⁾)	
Cable length	$\leq 100\ m$ (see the EnDat description in the <i>Interfaces of HEIDENHAIN Encoders</i> brochure)	
Supply voltage	DC 3.6 V to 14 V	<i>Rotary encoder U_P</i> : DC 3.6 V to 14 V <i>Buffer battery U_{Bat}</i> : DC 3.6 to 5.25 V
Power consumption ³⁾ (maximum)	At 3.6 V: $\leq 630\ mW$; at 14 V: $\leq 700\ mW$	
Current consumption (typical)	At 5 V: 95 mA (without load)	<i>Normal mode at 5 V</i> : 95 mA (without load) <i>Buffer mode⁴⁾</i> : 220 μA (rotating shaft) 25 μA (at standstill)
Shaft	Hollow through shaft ($\varnothing 90\ mm$)	
Shaft speed	$\leq 6000\ rpm$	
Moment of inertia of rotor	$4.26 \cdot 10^{-4}\ kgm^2$ (without screws)	
Angular acceleration of rotor	$\leq 2 \cdot 10^4\ rad/s^2$	
Axial motion of measured shaft	$\leq \pm 1.5\ mm$	
Vibration 55 to 2000 Hz ⁵⁾ Shock 6 ms	<i>AE scanning unit</i> : $\leq 400\ m/s^2$; <i>TTR scale drum</i> : $\leq 600\ m/s^2$ (EN 60068-2-6) $\leq 2000\ m/s^2$ (EN 60068-2-27)	
Operating temperature	–40 °C to 115 °C (at the measuring point and on the entire scale drum)	
Trigger threshold for exceeded temperature error message	130 °C (measuring accuracy of the internal temperature sensor: $\pm 1\ K$)	
Relative humidity	$\leq 93\%$ (40 °C/21 d as per EN 60068-2-78); condensation excluded	
Protection class EN 60529	<i>Complete encoder, mounted</i> : IP20 ⁶⁾ ; <i>scanning unit</i> : IP40 (read about insulation under <i>Electrical safety</i> in the <i>Interfaces of HEIDENHAIN Encoders</i> brochure)	
Mass	<i>AE scanning unit</i> : $\approx 0.27\ kg$; <i>TTR scale drum</i> : $\approx 0.17\ kg$	

¹⁾ Further tolerances may arise in the downstream electronics after position value comparison (contact mfr. of the downstream electronics)

²⁾ See *Temperature measurement in motors* in the *Encoders for Servo Drives* brochure

³⁾ See *General electrical information* in the *Interfaces of HEIDENHAIN Encoders* brochure

⁴⁾ At $T = 25\ ^\circ C$; $U_{Bat} = 3.6\ V$

⁵⁾ AE: 10 Hz to 55 Hz, 6.5 mm constant peak to peak; TTR: 10 Hz to 55 Hz, 10 mm constant peak to peak

⁶⁾ The encoder must be protected from abrasive and harmful media in the application; use an appropriate enclosure as needed.

EBI 4010: external backup battery

The multifunctionality of the EBI 4010 is realized through a revolution counter. To ensure that the absolute position information is available after a power failure, the EBI must be operated with an external backup battery.

A 3.6 V, 1200 mAh lithium thionyl chloride battery is recommended for the backup battery. The typical service life is over six years under the appropriate conditions (two shifts of ten hours each in normal operation; a battery temperature of 25 °C; typical self-discharging). To reach the typical service life, the main power supply (U_P) must be connected to the encoder during or immediately after connection of the backup battery so that the encoder is fully initialized after being completely without power. Otherwise, the encoder will consume a significantly higher amount of battery current until main power is first supplied.

To prevent damage to the encoder, ensure correct polarity of the backup battery. HEIDENHAIN recommends operating each encoder with a separate battery.

If the application requires compliance with DIN EN 60086-4 or UL 1642, an appropriate protective circuit is required for protection from wiring errors.

If the backup battery voltage falls below certain thresholds, then the encoder will issue the following warnings or error messages transmitted via the EnDat interface:

- **“Battery charge” warning**
≤ 2.8 V ± 0.2 V in normal mode
- **“M power failure” error message**
≤ 2.2 V ± 0.2 V in battery-buffered mode (encoder must be referenced again)

A low level of battery current continues to flow even during normal operation of the EBI. The amount of current depends on the operating temperature.

Please note:

Compliance with EnDat Specification 297403 and the EnDat Application Notes 722024, Chapter 13, *Battery-buffered encoders*, is required for correct control of the encoder.

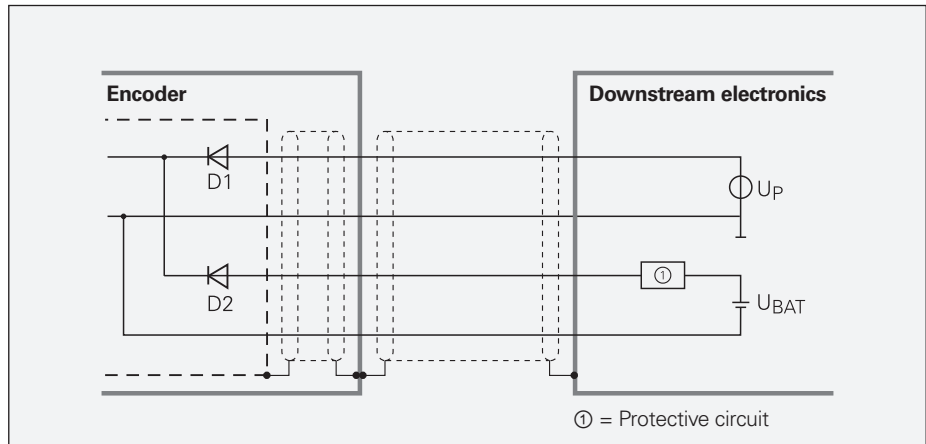

Backup battery connection

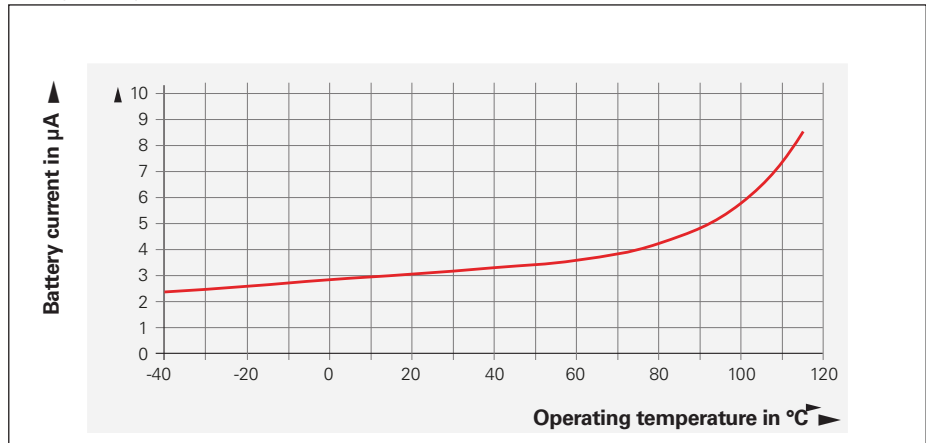

Typical discharge current in normal mode ($U_{BAT} = 3.6 V$)

Mounting

The scale drum of the rotary encoder is pressed onto the measured shaft's centering collar and fastened. The stator is mounted via an external centering diameter. In each case, use screws with material bonding anti-rotation lock (see *Mounting accessories*).

Requirements on the motor side for a safe mechanical coupling:

	Mating shaft / Mating stator	
Material	Steel	Aluminum
Tensile strength R_m	$\geq 600 \text{ N/mm}^2$	$\geq 220 \text{ N/mm}^2$
Shear strength τ_m	$\geq 390 \text{ N/mm}^2$	$\geq 130 \text{ N/mm}^2$
Interface pressure P_G	$\geq 660 \text{ N/mm}^2$	$\geq 250 \text{ N/mm}^2$
Surface roughness R_z	$\leq 16 \mu\text{m}$	
Coefficient of thermal expansion α_{therm} (at 20 °C)	$(10 \text{ to } 17) \cdot 10^{-6} \text{ K}^{-1}$	$\leq 25 \cdot 10^{-6} \text{ K}^{-1}$

Protection against contact (EN 60529)

After encoder installation, all rotating parts must be protected from accidental contact during operation.

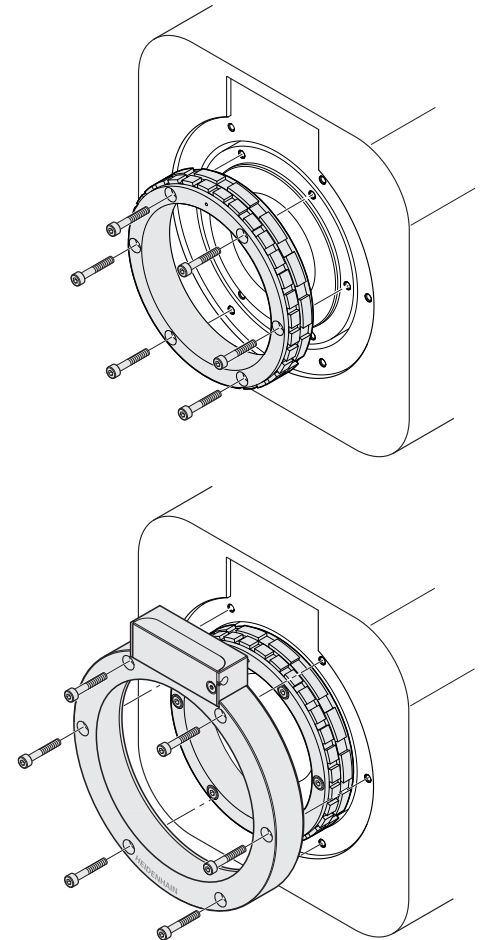

Mounting accessories

Screws

Screws are not included in delivery. They can be ordered separately.

ECI 4010/EBI 4010	Screws ¹⁾		Lot size
Fastening screws for stator and rotor	ISO 4762-M4x25-8.8-MKL	ID 202264-88	60 or 300

¹⁾ With coating for material bonding anti-rotation lock

Please note the information on screws from HEIDENHAIN in the *Encoders for Servo Drives* brochure, under the heading *Rotary encoders with functional safety* in the chapter *General mechanical information*.

Mounting aid

The mounting aid is used for plugging and unplugging the PCB connector. It prevents damage to the wires and crimp contacts because the strain is applied only to the connector. The wires must not be pulled.





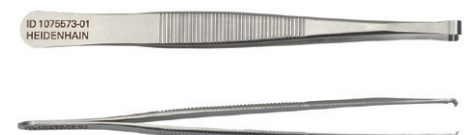



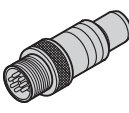

ID 1075573-01

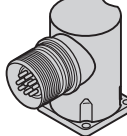
For further mounting information and mounting aids, please refer to the relevant mounting instructions and the *Encoders for Servo Drives* brochure.

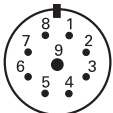

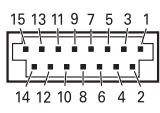





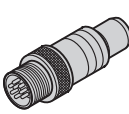

Electrical connection: pin layout

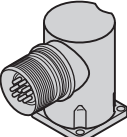
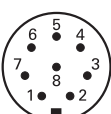
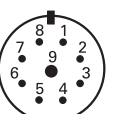
Pin layout of the ECI

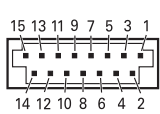
8-pin M12 coupling		9-pin M23 right-angle socket				15-pin PCB connector					
											
	Power supply				Serial data transmission				Other signals ¹⁾		
 M12	8	2	5	1	3	4	7	6	/	/	
 M23	3	7	4	8	5	6	1	2	/	/	
	13	11	14	12	7	8	9	10	5	6	
	U_P	Sensor U_P	0V	Sensor 0V	DATA	$\overline{\text{DATA}}$	CLOCK	$\overline{\text{CLOCK}}$	T_+ ²⁾	T_- ²⁾	
	Brown/ Green	Blue	White/ Green	White	Gray	Pink	Violet	Yellow	Brown	Green	

Pin layout of EBI

8-pin M12 coupling		9-pin M23 right-angle socket				15-pin PCB connector					
											
	Power supply				Serial data transmission				Other signals ¹⁾		
 M12	8	2	5	1	3	4	7	6	/	/	
 M23	3	7	4	8	5	6	1	2	/	/	
	13	11	14	12	7	8	9	10	5	6	
	U_P	U_{BAT}	0V ³⁾	0V BAT ³⁾	DATA	$\overline{\text{DATA}}$	CLOCK	$\overline{\text{CLOCK}}$	T_+ ²⁾	T_- ²⁾	
	Brown/ Green	Blue	White/ Green	White	Gray	Pink	Violet	Yellow	Brown	Green	

¹⁾ Only with output cables inside the motor housing

²⁾ Connections for external temperature sensor (depending on the encoder cable inside the motor); evaluation optimized for KTY 84-130 (see *Temperature measurement in motors* in the *Encoders for Servo Drives* brochure)

³⁾ Connected inside encoder

Cable shield connected to housing; U_P = Power supply voltage



Sensor: The sense line is connected in the encoder with the corresponding power supply line.

Vacant pins or wires must not be used!

Note for safety-related applications: Only completely assembled HEIDENHAIN cables are qualified. Do not modify cables or exchange their connectors without first consulting with HEIDENHAIN Traunreut!

Electrical connection



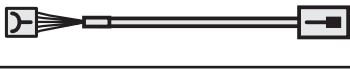

Kabel

EPG encoder cable inside the motor housing \varnothing 3.7 mm; [(1 x 4 x 0.06) + (4 x 0.06)] mm ² ; A _P = 0.06 mm ² ; TPE wires for temperature sensor [2 x 0.16] mm ²		
With 15-pin PCB connector and 9-pin M23 SpeedTEC angle flange socket (male); wires for temperature sensor		ID 1120940-30 ¹⁾ ; length: 0.3 m
With 15-pin PCB connector and 9-pin M23 SpeedTEC angle flange socket (male)		ID 1121041-03 ¹⁾ ; length: 0.3 m
With 15-pin PCB connector and 8-pin M12 coupling (male)		ID 1287818-01 ²⁾ ; length: 1 m

CE compliance of the complete system must be documented.

¹⁾ Operating temperature range (conditional): -20 °C to 120 °C

²⁾ Operating temperature range (conditional): -40 °C to 85 °C

PUR connecting cable \varnothing 6 mm ; [(4 x 0.14 mm ²) + (4 x 0.34 mm ²)]; A _P = 0.34 mm ²	8-pin M12 connector	9-pin M23 connector
With M12 connector (female) and 8-pin M12 coupling (male)		ID 368330-xx
8-pin M12 connector (female) and 15-pin D-sub connector (female)		ID 533627-xx
8-pin M12 connector (female) and 15-pin D-sub connector (male)		ID 524599-xx
With one 8-pin M12 connector (female)		ID 634265-xx ¹⁾

A_P: Cross section of power supply lines

¹⁾ Connecting element must be suitable for the maximum clock frequency used

Note for safety-related applications: Document the bit error rate in accordance with Specification 533095!

SpeedTEC is a registered trademark of Intercontec Pfeiffer Industriesteckverbindungen GmbH.

HEIDENHAIN

DR. JOHANNES HEIDENHAIN GmbH

Dr.-Johannes-Heidenhain-Straße 5

83301 Traunreut, Germany

☎ +49 8669 31-0

☎ +49 8669 32-5061

E-mail: info@heidenhain.de

www.heidenhain.de

This Product Information document supersedes all previous editions, which thereby become invalid. The basis for ordering from HEIDENHAIN is always the Product Information valid when the contract is placed.

Related documents: Adhere to the information in the following documents to ensure the correct and intended operation of the encoder:

- *Encoders for Servo Drives* brochure: ID 208922-xx
- *AE EC14010, EB14010 Mounting Instructions*: ID 1152725-xx
- and *TTR EXI4000*: ID 1147618-xx
- Technical Information: *Safety-Related Position Measuring Systems*: ID 596632-xx
- For implementation in a safe control or inverter: Specification: ID 533095-xx
- and *Supplementary Measures Catalog (SIL 3, PL e)*: ID 1000344-xx
- Brochure: *Interfaces of HEIDENHAIN Encoders*: ID 1078628-xx