

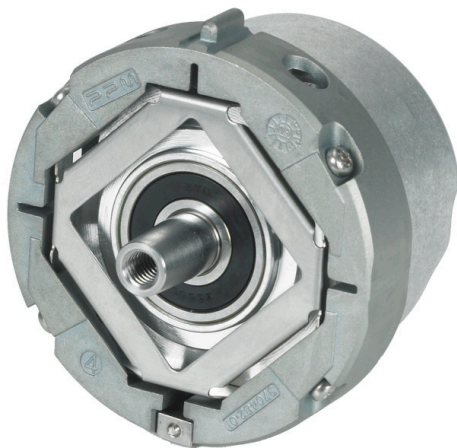

# HEIDENHAIN



Product Information

## **ECN 1324S** **EQN 1336S**

Absolute Rotary Encoders with  
DRIVE-CLiQ Interface for  
Safety-Related Applications

# ECN 1324S, EQN 1336S

Rotary encoders for absolute position values with safe singleturn information

- Installation diameter 65 mm
- Expanding ring coupling 07B
- Taper shaft 65B

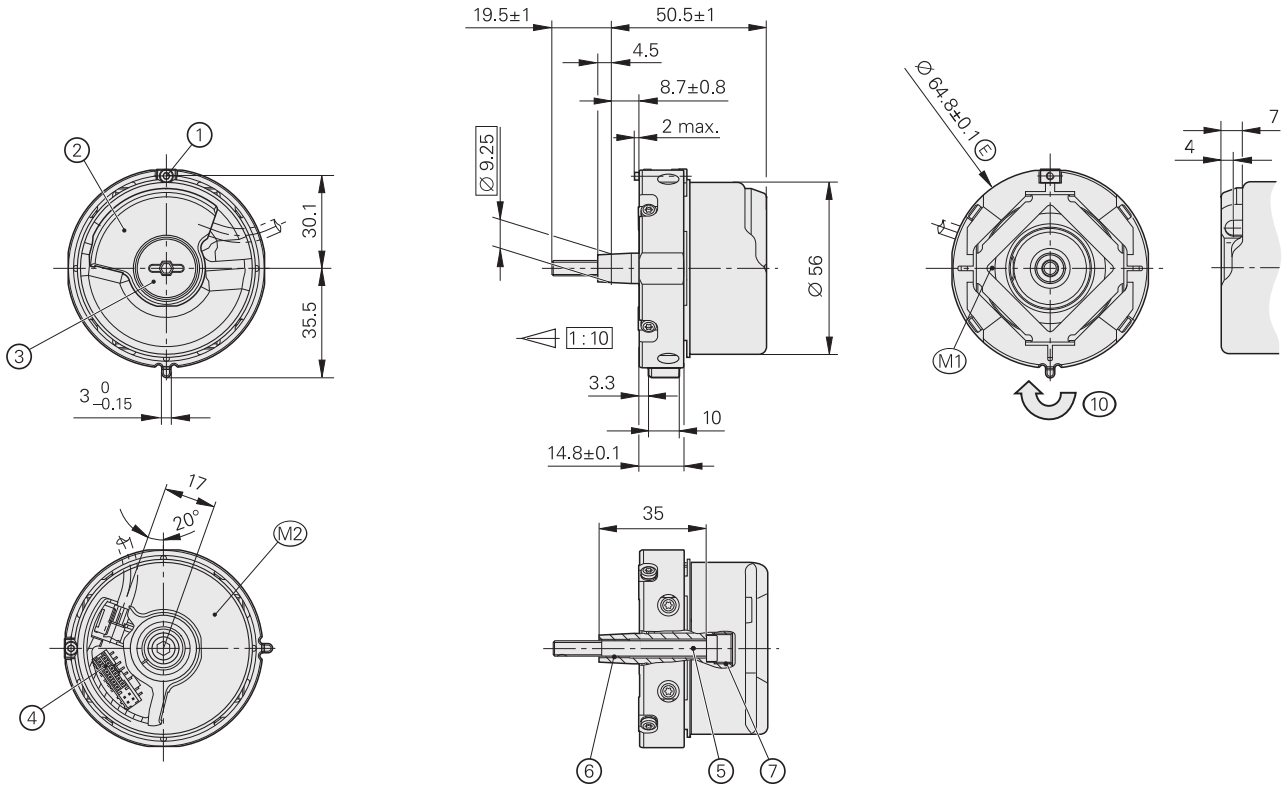

## Required mating dimensions

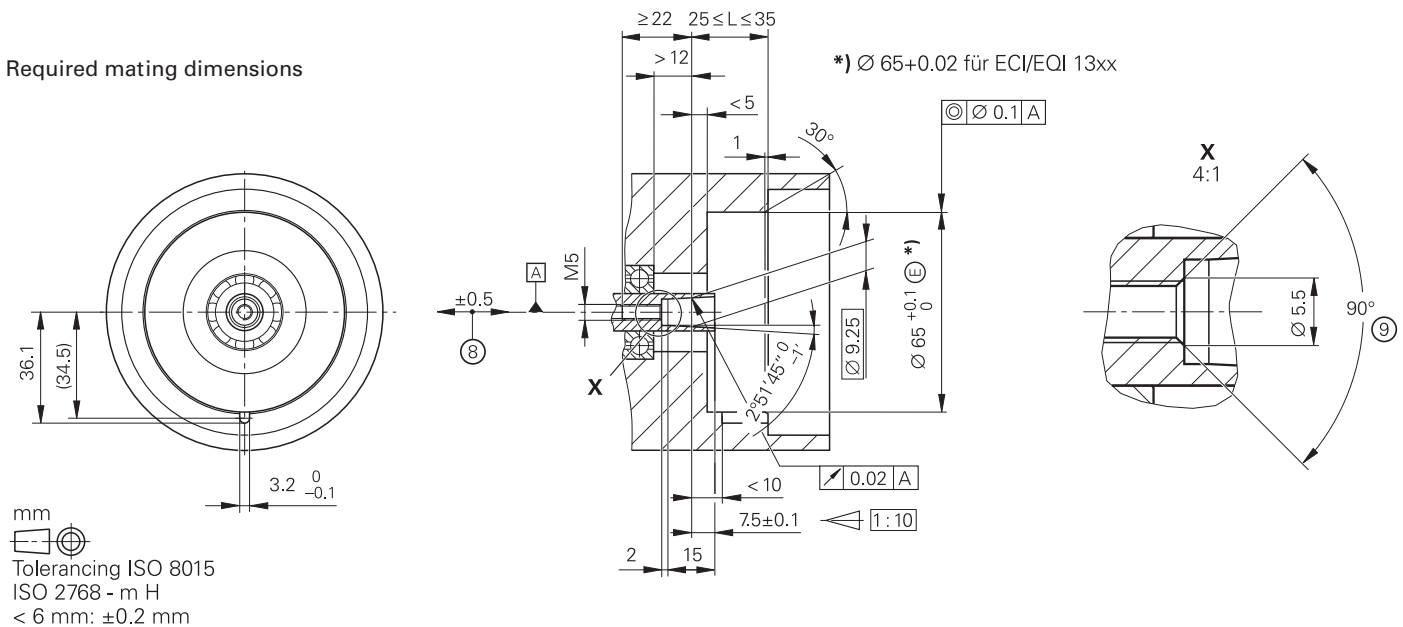

= Bearing of mating shaft

M1= Measuring point for operating temperature

M2= Measuring point for vibration, see D 741714

1 = Clamping screw for coupling ring, width A/F 2, tightening torque 1.25–0.2 Nm

2 = Die-cast cover

3 = Screw plug, widths A/F 3 and 4, tightening torque 5+0.5 Nm

4 = Plug connector, 12-pin + 4-pin

5 = Screw DIN 6912 – M5x50 – 08.8 – MKL width A/F 4, tightening torque 5+0.5 Nm

6 = Back-off thread M6

7 = Back-off thread M10

8 = Compensation of mounting tolerances and thermal expansion, no dynamic motion permitted

9 = Chamfer is obligatory at start of thread for materially bonding anti-rotation lock

10 = Direction of shaft rotation for output signals as per the interface description

Specifications	ECN 1324S – Singleturm	EQN 1336S – Multiturm
These data apply for	ID 1042274-01	ID 1042276-01
<b>Functional safety</b> For applications up to	As single-encoder system for monitoring and closed-loop functions <ul style="list-style-type: none"> <li>• SIL 2 according to EN 61508 (further basis for testing: EN 61800-5-2)</li> <li>• Category 3 PL d according to EN ISO 13849-1:2008</li> </ul> Safe in the singleturm range	
PFH <sup>1)</sup>	≤ 27 × 10 <sup>-9</sup> (probability of dangerous failure per hour)	
Safe position <sup>2)</sup>	<i>Device:</i> ± 1.76° (safety-relevant measuring step SM = 0.7°) <i>mechanical coupling:</i> ± 2° (fault exclusion for loosening of shaft and stator coupling, designed for accelerations ≤ 300 m/s <sup>2</sup> )	
<b>Interface</b>	DRIVE-CLiQ	
Ordering designation	DQ01	
Siemens software (version 12. 2. 2014)	SINAMICS, SIMOTION: ≥ V4.4 HF4; SINUMERIK with safety: ≥ V4.4 SP2	
Position values/revolution	16 777 216 (24 bits)	
Revolutions	-	4096 (12 bits)
Processing time Time_max_actual	≤ 8 μs	
<b>System accuracy</b>	± 20"	
<b>Electrical connection</b>	PCB connector <i>Rotary encoder:</i> 12-pin <i>Temperature sensor:</i> <sup>3)</sup> 4-pin	
Cable length	≤ 30 m (see the <i>Interfaces of HEIDENHAIN Encoders</i> brochure; with n <sub>MG</sub> = 1 incl. adapter cable)	
Voltage supply	DC 24 V (10 V to 28.8 V)  (possible up to DC 36.0 V without impairment of functional safety)	
Power consumption <sup>4)</sup> (maximum)	At 10 V: ≤ 900 mW; at 28.8 V: ≤ 1000 mW	At 10 V: ≤ 1000 mW; at 28.8 V: ≤ 1140 mW
Current consumption (typical)	At 24 V: 38 mA (without load)	At 24 V: 43 mA (without load)
<b>Shaft*</b>	Taper shaft Ø 9.25 mm; taper 1:10	
Speed	≤ 15 000 rpm (at ≥ 2 position requests per rev.)	≤ 12 000 rpm (at ≥ 2 position requests per rev.)
Starting torque at 20 °C	≤ 0.01 Nm	
Moment of inertia of rotor	2.6 × 10 <sup>-6</sup> kgm <sup>2</sup>	
Angular acceleration of rotor	≤ 1 × 10 <sup>5</sup> rad/s <sup>2</sup>	
Axial motion of measured shaft	≤ ± 0.5 mm	
<b>Vibration</b> 55 to 2000 Hz <sup>5)</sup> <b>Shock</b> 6 ms	≤ 300 m/s <sup>2</sup> (EN 60 068-2-6) ≤ 2000 m/s <sup>2</sup> (EN 60 068-2-27)	
<b>Operating temperature</b>	-30 °C to 100 °C	
<b>Trigger threshold</b> of error message for excessive temperature	125 °C (measuring accuracy of the internal temperature sensor: ± 7 K)	
<b>Relative humidity</b>	≤ 93 % (40 °C/21 d as per EN 60 068-2-78); without condensation	
<b>Protection</b> EN 60 529	IP 40 (see <i>Insulation</i> under <i>General mechanical information</i> in the <i>Encoders for Servo Drives</i> catalog; contamination due to the intrusion of liquids must be avoided)	
<b>Mass</b>	≈ 0.25 kg	

\* Please select when ordering

- 1) For application elevation ≤ 1000 m above sea level
- 2) Further tolerances may occur in subsequent electronics after position value comparison (contact manufacturer of subsequent electronics)
- 3) See *Temperature measurement in motors* in the *Encoders for Servo Drives* catalog.
- 4) See *General electrical information* in the *Interfaces of HEIDENHAIN Encoders* brochure
- 5) 10 Hz to 55 Hz, constant over distance, 4.9 mm peak to peak

# ECN 1324S, EQN 1336S

Rotary encoders for absolute position values with safe singleturn information

- Installation diameter 65 mm
- Expanding ring coupling 07B
- Blind hollow shaft for axial clamping 67M

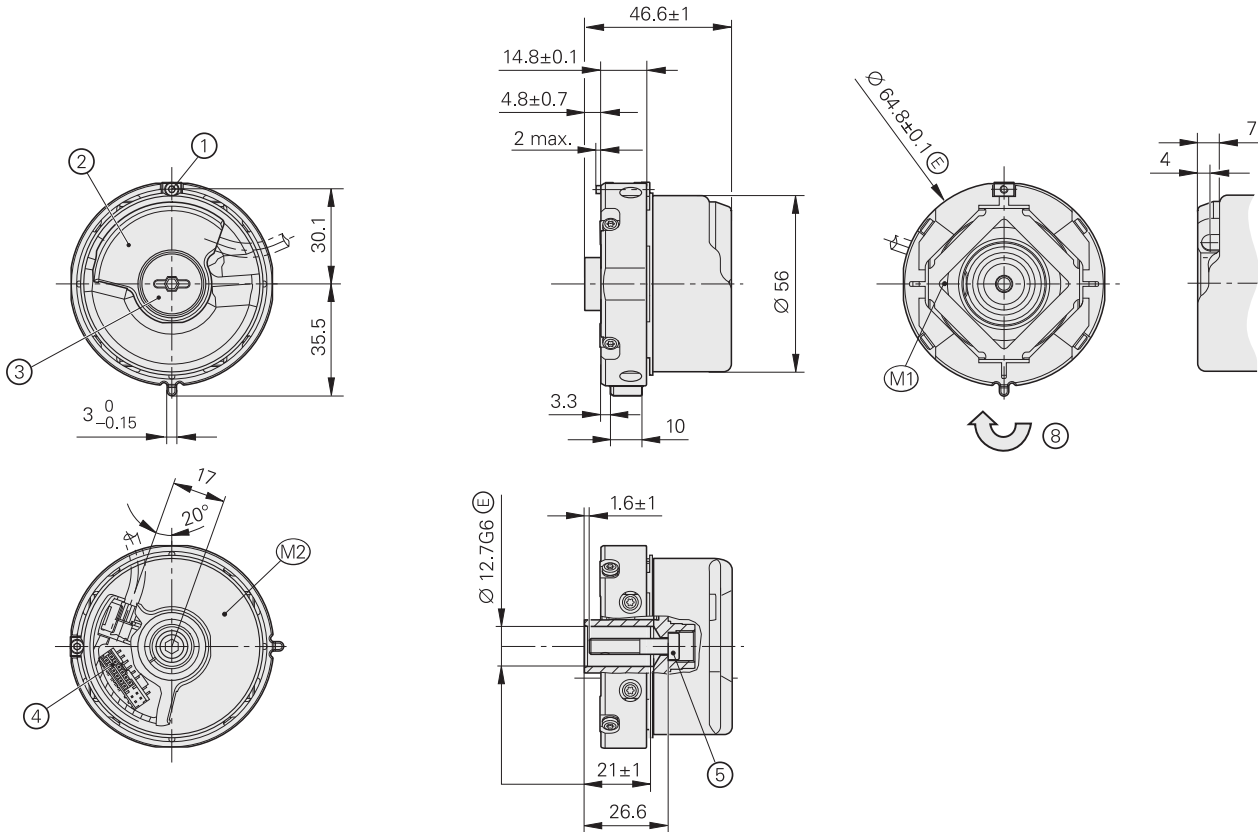

## Required mating dimensions

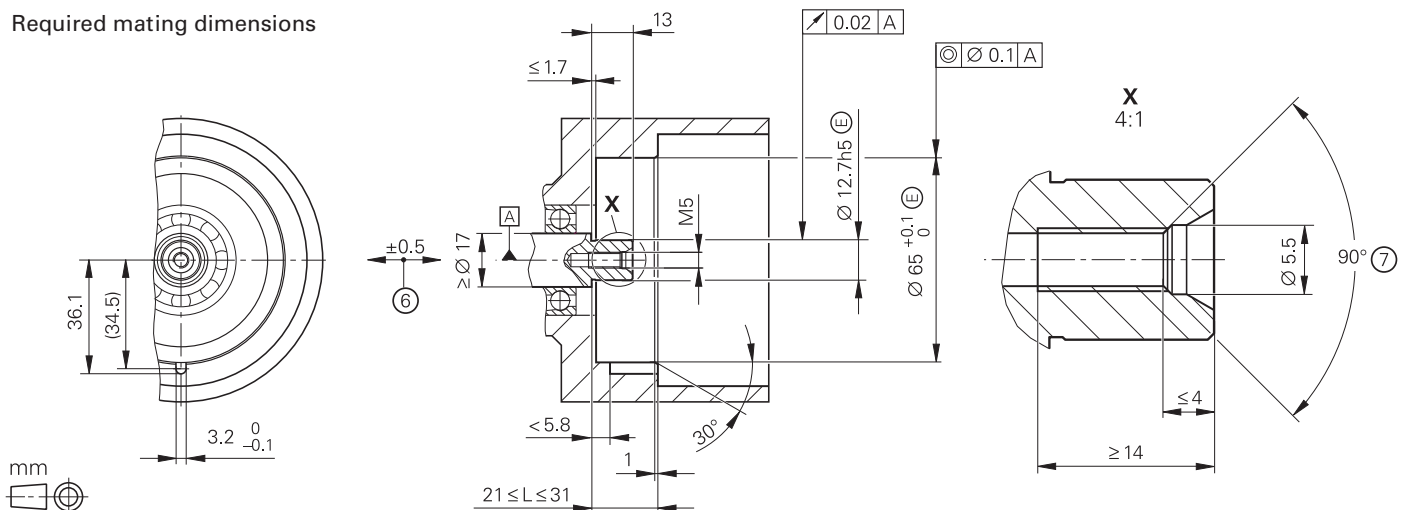

mm  
  
 Tolerancing ISO 8015  
 ISO 2768 - m H  
 < 6 mm: ±0.2 mm

- ▣ = Bearing of mating shaft
- M1 = Measuring point for operating temperature
- M2 = Measuring point vibration, see D741714
- 1 = Clamping screw for coupling ring, width A/F 2, tightening torque 1.25–0.2 Nm
- 2 = Die-cast cover
- 3 = Screw plug, widths A/F 3 and 4, tightening torque 5+0.5 Nm
- 4 = Plug connector, 12-pin + 4-pin
- 5 = Screw DIN 6912 – M5x25 – 08.8 – MKL width A/F 4, tightening torque 5+0.5 Nm
- 6 = Compensation of mounting tolerances and thermal expansion, no dynamic motion permitted
- 7 = Chamfer is obligatory at start of thread for materially bonding anti-rotation lock
- 8 = Direction of shaft rotation for output signals as per the interface description

Specifications	ECN 1324S – Singleturm	EQN 1336S – Multiturm
These data apply for	ID 1042274-03	ID 1042276-02
<b>Functional safety</b> For applications up to	As single-encoder system for monitoring and closed-loop functions <ul style="list-style-type: none"> <li>• SIL 2 according to EN 61508 (further basis for testing: EN 61800-5-2)</li> <li>• Category 3 PL d according to EN ISO 13849-1:2008</li> </ul> Safe in the singleturm range	
PFH <sup>1)</sup>	≤ 27 × 10 <sup>-9</sup> (probability of dangerous failure per hour)	
Safe position <sup>2)</sup>	<i>Device:</i> ± 1.76° (safety-relevant measuring step SM = 0.7°) <i>mechanical coupling:</i> ± 2° (fault exclusion for loosening of shaft and stator coupling, designed for accelerations ≤ 300 m/s <sup>2</sup> )	
<b>Interface</b>	DRIVE-CLiQ	
Ordering designation	DQ01	
Siemens software (version 12. 2. 2014)	SINAMICS, SIMOTION: ≥ V4.4 HF4; SINUMERIK with safety: ≥ V4.4 SP2	
Position values/revolution	16 777 216 (24 bits)	
Revolutions	-	4096 (12 bits)
Processing time Time_max_actual	≤ 8 μs	
<b>System accuracy</b>	± 20"	
<b>Electrical connection</b>	PCB connector <i>Rotary encoder:</i> 12-pin <i>Temperature sensor:</i> <sup>3)</sup> 4-pin	
Cable length	≤ 30 m (see the <i>Interfaces of HEIDENHAIN Encoders</i> brochure; with n <sub>MG</sub> = 1 incl. adapter cable)	
Voltage supply	DC 24 V (10 V to 28.8 V) (possible up to DC 36.0 V without impairment of functional safety)	
Power consumption <sup>4)</sup> (maximum)	At 10 V: ≤ 900 mW; at 28.8 V: ≤ 1000 mW	At 10 V: ≤ 1000 mW; at 28.8 V: ≤ 1140 mW
Current consumption (typical)	At 24 V: 38 mA (without load)	At 24 V: 43 mA (without load)
<b>Shaft*</b>	Blind hollow shaft for axial clamping Ø 12.7 mm	
Speed	≤ 12 000 rpm (at ≥ 2 position requests per revolution)	
Starting torque at 20 °C	≤ 0.01 Nm	
Moment of inertia of rotor	3.2 × 10 <sup>-6</sup> kgm <sup>2</sup>	
Angular acceleration of rotor	≤ 5 × 10 <sup>4</sup> rad/s <sup>2</sup>	
Axial motion of measured shaft	≤ ± 0.5 mm	
<b>Vibration</b> 55 to 2000 Hz <sup>5)</sup> <b>Shock</b> 6 ms	≤ 300 m/s <sup>2</sup> (EN 60 068-2-6) ≤ 2000 m/s <sup>2</sup> (EN 60 068-2-27)	
<b>Operating temperature</b>	-30 °C to 100 °C	
<b>Trigger threshold</b> of error message for excessive temperature	125 °C (measuring accuracy of the internal temperature sensor: ± 7 K)	
<b>Relative humidity</b>	≤ 93 % (40 °C/21 d as per EN 60 068-2-78); without condensation	
<b>Protection</b> EN 60 529	IP 40 (see <i>Insulation</i> under <i>General mechanical information</i> in the <i>Encoders for Servo Drives</i> catalog; contamination due to the intrusion of liquids must be avoided)	
<b>Mass</b>	≈ 0.25 kg	

\* Please select when ordering

- 1) For application elevation ≤ 1000 m above sea level
- 2) Further tolerances may occur in the subsequent electronics after the position value comparison (contact the manufacturer of the subsequent electronics)
- 3) See *Temperature measurement in motors* in the *Encoders for Servo Drives* catalog.
- 4) See *General electrical information* in the *Interfaces of HEIDENHAIN Encoders* brochure
- 5) 10 Hz to 55 Hz, constant over distance, 4.9 mm peak to peak

# Mounting

The shaft of the rotary encoder is slid onto the motor's drive shaft and fastened with a central screw. It is particularly important to ensure that the positive-locking element of the stator coupling securely engages the corresponding slot in the mating part. Use a screw with materially bonding anti-rotation locking (see *Mounting accessories*). The stator coupling is clamped by an axially tightened screw in a location bore.

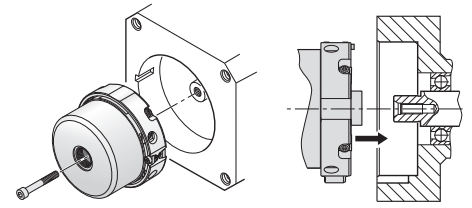

Conditions required on the motor side for a safe mechanical connection:

	Mating shaft	Mating stator
Material	Steel	Aluminum
Tensile strength $R_m$	$\geq 600 \text{ N/mm}^2$	$\geq 220 \text{ N/mm}^2$
Interface pressure $P_G$	$\geq 500 \text{ N/mm}^2$	$\geq 200 \text{ N/mm}^2$
Surface roughness $R_z$	$\leq 10 \mu\text{m}$	$\leq 10 \mu\text{m}$
Coefficient of expansion $\alpha_{\text{therm}}$	$(10 \text{ to } 17) \times 10^{-6} \text{ K}^{-1}$	$\leq 25 \times 10^{-6} \text{ K}^{-1}$

The following maximum torque  $M_{\text{max}}$  is to be used when designing the mechanical fault exclusion for the shaft connection:

$$M_{\text{max}} = J \times \alpha + 0.2 \text{ Nm}$$

where

J: Rotor moment of inertia (see Specifications of the encoder)

$\alpha$ : Rotor angular acceleration (see Specifications of the encoder)

The customer's mechanical design must ensure that the maximum torque  $M_{\text{max}}$  occurring in the application can be transmitted.

## Mounting accessories

### Screws

Screws (central screw, mounting screws) are not included in delivery. They can be ordered separately.

ECN 1324S, EQN 1336S	Central screws for fastening the shaft <sup>1)</sup>		Lot size
For taper shaft 65B	DIN 6912-M5×50-08.8-MKL	ID 202264-54	10 or 100 pieces
For hollow shaft 67M	DIN 6912-M5×25-08.8-MKL	ID 202264-55	

1) With coating for materially bonding anti-rotation lock

Please note the information on screws from HEIDENHAIN in the catalog titled *Encoders for Servo Drives*, chapter *General mechanical information* under *Rotary encoders with functional safety*.

### Mounting aid

The mounting aid serves to plug and unplug the PCB connector. It prevents damage to the cable because the strain is applied only to the connector. The wires themselves must not be strained.

ID 1075573-01

For further mounting information and mounting aids, refer to the *Encoders for servo drives catalog*.

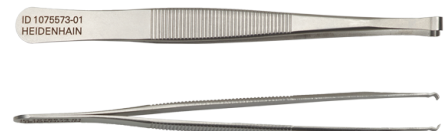

# Integrated temperature evaluation

These rotary encoders feature an internal temperature sensor integrated in the encoder electronics as well as an evaluation circuit for an external temperature sensor. In both cases, the respective digitized temperature value is transmitted purely serially over the DRIVE-CLiQ interface. It must be noted that the temperature measurement and the transmission of the temperature value are not "safe" in the sense of functional safety.

The temperature measured by the internal temperature sensor is higher by a device-specific and application-specific amount than the temperature at the measuring point M1 in accordance with the dimension drawing.

The rotary encoders output the error message "Alarm 405" if the internal temperature reaches a specific threshold. This threshold depends on the encoder model and is shown in the specifications. Keeping a sufficient distance from the error-message threshold is recommended during operation.

The encoder's intended use requires compliance with the operating temperature at the measuring point M1.

# Electrical requirements

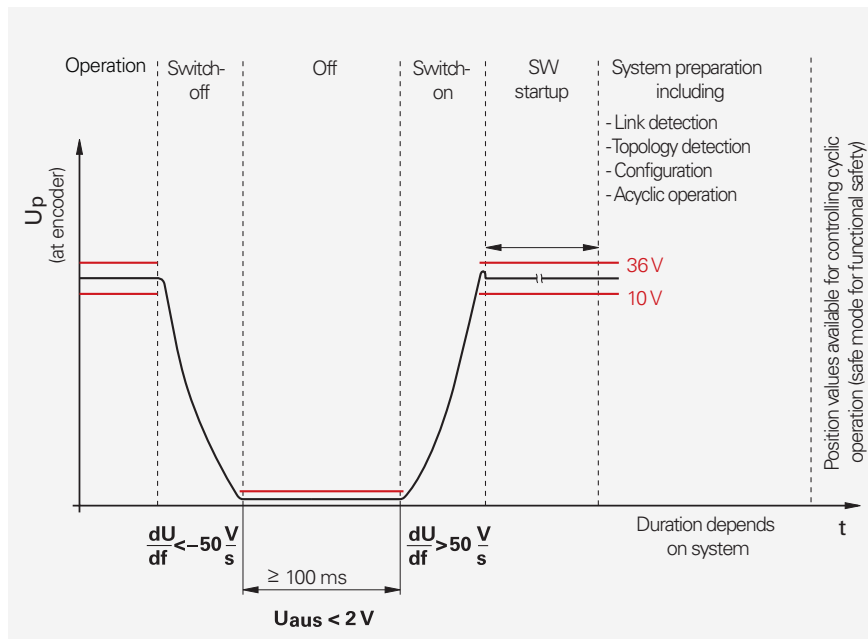

## Switch-on and switch-off conditions









# Electrical connection

## Cables

<b>Cables inside the motor housing</b> EPG Ø 3.7 mm; [2×2×0.06 mm + 4×0.06 mm <sup>2</sup> ]		
Complete with PCB connector (12-pin and 4-pin) and <b>M12</b> flange socket (male), 8-pin; with wires for temperature sensor		ID 1138203-xx <sup>1)</sup>
Complete with PCB connector (12 and 4 pin) and <b>M23-SpeedTEC</b> right-angle socket (male) 9-pin; with wires for temperature sensor		ID 1120945-xx

1) **Note for safety-related applications:** Provide bit error rate!









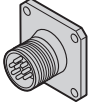

<b>PUR connecting cable</b> Ø 6.8 mm; [2×2×0.17 mm <sup>2</sup> + (2×0.24 mm <sup>2</sup> )]; A <sub>P</sub> = 0.24 mm <sup>2</sup>		
<b>Complete</b> with M12 connector (female) and M12 coupling (male), 8 pins each		ID 822504-xx
<b>Complete</b> with 8-pin M12 connector (female) and Siemens RJ45 connector (IP 67)		ID 1094652-xx
<b>Complete</b> with 8-pin M12 connector (female) and Siemens RJ45 connector (IP20)		ID 1093042xx
<b>Complete</b> with M23 SpeedTEC connector (female) and Siemens RJ45 connector (IP20)		ID 1121546-xx
<b>Complete</b> with M23 SpeedTEC connector (female) and M12 coupling (male), 8-pin		ID 1121536-xx

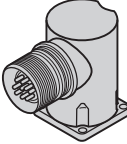
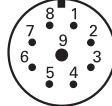
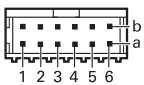
A<sub>P</sub>: Cross section of power supply lines

SpeedTEC is a registered trademark of Intercontec Pfeiffer Industriesteckverbindungen GmbH.

# Electrical connection

## Pin layout

<b>8-pin flange socket, M12</b>   		<b>9-pin M23 right-angle socket</b>   						
<b>12-pin PCB connector</b>  		<b>4-pin PCB connector</b>  						
	Voltage supply		Absolute position values				Other signals <sup>1)</sup>	
 M12	1	5	3	4	7	6	/	/
 M23	8	4	5	6	1	2	/	/
 12	3a	4b	6b	1a	2b	5a	/	/
 4	/	/	/	/	/	/	1a	1b
	<b>U<sub>p</sub></b>	<b>0 V</b>	<b>RXP</b>	<b>RXN</b>	<b>TXP</b>	<b>TXN</b>	<b>T<sup>+</sup></b> <sup>2)</sup>	<b>T<sup>-</sup></b> <sup>2)</sup>
	White	White/Green	Gray	Pink	Violet	Yellow	Brown	Green

1) Only with output cables inside the motor

2) Connections for external temperature sensor; evaluation optimized for KTY 84-130 (see *Temperature measurement in motors* in the *Encoders for Servo Drives* catalog)

**Cable shield** connected to housing; **U<sub>p</sub>** = Power supply

Vacant pins or wires must not be used!

**Encoder cables with a cable length > 0.5 m require strain relief of the cable**

DRIVE-CLiQ, SINUMERIK, SINAMICS and SIMOTION are registered trademarks of Siemens Aktiengesellschaft

# HEIDENHAIN

**DR. JOHANNES HEIDENHAIN GmbH**

Dr.-Johannes-Heidenhain-Straße 5

**83301 Traunreut, Germany**

☎ +49 8669 31-0

FAX +49 8669 5061

E-mail: [info@heidenhain.de](mailto:info@heidenhain.de)

[www.heidenhain.de](http://www.heidenhain.de)

This Product Information supersedes all previous editions, which thereby become invalid. The basis for ordering from HEIDENHAIN is always the Product Information valid when the contract is made.

**Related documents:** Adhere to the information in the following documents to ensure the correct and intended operation of the encoder:

- Catalog: *Position Encoders for Servo Drives*: 208922-xx
- *ECN 1324S, EQN 1336S* Mounting Instructions: 1038275-xx
- Technical Information: *Safety-Related Position Measuring Systems* 596632