



## TNC 620

User's Manual  
Conversational Programming

NC Software  
817600-05  
817601-05  
817605-05

English (en)  
10/2017







## Controls and displays

### Keys





If you are using a TNC 620 with touch control, you can replace some keystrokes with hand-to-screen contact.

**Further information:** "Operating the Touchscreen", page 123



### Keys on visual display unit

Key	Function
	Selecting the screen layout
	Toggle the display between machine operating mode, programming mode, and a third desktop
	Soft keys for selecting functions on screen
  	Shifting between soft-key rows















### Machine operating modes

Key	Function
	Manual operation
	Electronic handwheel
	Positioning with manual data input
	Program run, single block
	Program run, full sequence



### Programming modes

Key	Function
	Programming
	Test run









## Entering and editing coordinate axes and numbers

Key	Function
 ... 	Select coordinate axes or enter them in a program
 ... 	Numbers
 	Decimal separator / Reverse algebraic sign
 	Polar coordinate entry / Incremental values
	Q parameter programming / Q parameter status
	Capture actual position
	Skip dialog questions, delete words
	Confirm entry and resume dialog
	Conclude block and exit entry
	Clear entries or error message
	Abort dialog, delete program section











### Tool functions

Key	Function
	Define tool data in the program
	Call tool data







## Managing programs and files, control functions

Key	Function
	Select or delete programs and files, external data transfer
	Define program call, select datum and point tables
	Select MOD functions
	Display help text for NC error messages, call TNCguide
	Display all current error messages
	Show calculator
	Show special functions
	Open the batch process manager









## Navigation keys

Key	Function
 	Position the cursor
	Go directly to blocks, cycles and parameter functions
	Navigate to the program start or table start
	Navigate to the program end or end of a table line
	Navigate up one page
	Navigate down one page
	Select the next tab in forms
 	Up/down one dialog box or button

## Cycles, subprograms and program section repeats

Key	Function
	Define touch probe cycles
 	Define and call cycles
 	Enter and call labels for subprogramming and program section repeats
	Enter program stop in a program

## Programming path movements

Key	Function
	Approach/depart contour
	FK free contour programming
	Straight line
	Circle center/pole for polar coordinates
	Circular arc with center
	Circle with radius
	Circular arc with tangential connection
 	Chamfer/rounding arc

## Potentiometer for feed rate and spindle speed

### Feed rate



### Spindle speed





**Fundamentals**

## About this manual

### Safety precautions

Comply with all safety precautions indicated in this document and in your machine tool builder's documentation!

Precautionary statements warn of hazards in handling software and devices and provide information on their prevention. They are classified by hazard severity and divided into the following groups:

#### **DANGER**

**Danger** indicates hazards for persons. If you do not follow the avoidance instructions, the hazard will **result in death or severe injury**.

#### **WARNING**

**Warning** indicates hazards for persons. If you do not follow the avoidance instructions, the hazard **could result in death or serious injury**.

#### **CAUTION**

**Caution** indicates hazards for persons. If you do not follow the avoidance instructions, the hazard **could result in minor or moderate injury**.

#### **NOTICE**

**Notice** indicates danger to material or data. If you do not follow the avoidance instructions, the hazard **could result in things other than personal injury, like property damage**.

### Sequence of information in precautionary statements

All precautionary statements comprise the following four sections:

- Signal word indicating the hazard severity
- Type and source of hazard
- Consequences of ignoring the hazard, e.g.: "There is danger of collision during subsequent machining operations"
- Escape – Hazard prevention measures

### Informational notes

Observe the informational notes provided in these instructions to ensure reliable and efficient operation of the software.

In these instructions, you will find the following informational notes:



The information symbol indicates a **tip**.  
A tip provides important additional or supplementary information.



This symbol prompts you to follow the safety precautions of your machine tool builder. This symbol also indicates machine-dependent functions. Possible hazards for the operator and the machine are described in the machine manual.



The book symbol represents a **cross reference** to external documentation, e.g. the documentation of your machine tool builder or other supplier.

### Would you like any changes, or have you found any errors?

We are continuously striving to improve our documentation for you. Please help us by sending your requests to the following e-mail address:

**tnc-userdoc@heidenhain.de**

## Control model, software and features

This manual describes functions and features provided by controls as of the following NC software numbers.

Control model	NC software number
TNC 620	817600-05
TNC 620 E	817601-05
TNC 620 Programming Station	817605-05

The suffix E indicates the export version of the control. The following software options are unavailable or only available to a limited extent in the export version:

- Advanced Function Set 2 (option 9) limited to four-axis interpolation

The machine manufacturer adapts the usable features of the control to his machine by the setting machine parameters. Some of the functions described in this manual may therefore not be among the features provided by the control on your machine tool.

Control functions that may not be available on your machine include:

- Tool measurement with the TT

In order to find out about the actual features of your machine, please contact the machine manufacturer.

Many machine manufacturers, as well as HEIDENHAIN, offer programming courses for the HEIDENHAIN controls. Participation in one of these courses is recommended to familiarize yourself thoroughly with the control's functions.



### **Cycle Programming User's Manual:**

All of the cycle functions (touch probe cycles and fixed cycles) are described in the Cycle Programming User's Manual. If you need this user's manual, please contact HEIDENHAIN if required. ID: 1096886-xx



## Software options

The TNC 620 features various software options that can be enabled by your machine tool builder. Each option is to be enabled separately and contains the following respective functions:

---

### Additional Axis (option 0 and option 1)

<b>Additional axis</b>	Additional control loops 1 and 2
------------------------	----------------------------------

---

### Advanced Function Set 1 (option 8)

<b>Expanded functions Group 1</b>	<p><b>Machining with rotary tables</b></p> <ul style="list-style-type: none"> <li>■ Cylindrical contours as if in two axes</li> <li>■ Feed rate in distance per minute</li> </ul> <p><b>Coordinate conversions:</b></p> <p>Tilting the working plane</p>
-----------------------------------	----------------------------------------------------------------------------------------------------------------------------------------------------------------------------------------------------------------------------------------------------------

---

### Advanced Function Set 2 (option 9)

<p><b>Expanded functions Group 2</b></p> <p>Export license required</p>	<p><b>3-D machining:</b></p> <ul style="list-style-type: none"> <li>■ Motion control with minimum jerk</li> <li>■ 3-D tool compensation through surface-normal vectors</li> <li>■ Using the electronic handwheel to change the angle of the swivel head during program run without affecting the position of the tool center point (tool tip or center of sphere) (TCPM = <b>T</b>ool <b>C</b>enter <b>P</b>oint <b>M</b>anagement)</li> <li>■ Keeping the tool normal to the contour</li> <li>■ Tool radius compensation perpendicular to traversing direction and tool direction</li> </ul> <p><b>Interpolation:</b></p> <p>Linear in 5 axes</p>
-------------------------------------------------------------------------	----------------------------------------------------------------------------------------------------------------------------------------------------------------------------------------------------------------------------------------------------------------------------------------------------------------------------------------------------------------------------------------------------------------------------------------------------------------------------------------------------------------------------------------------------------------------------------------------------------------------------------------------------

---

### Touch Probe Functions (option 17)

<b>Touch probe functions</b>	<p><b>Touch probe cycles:</b></p> <ul style="list-style-type: none"> <li>■ Compensation of tool misalignment in automatic mode</li> <li>■ Presetting in the <b>Manual operation</b> mode of operation</li> <li>■ Presetting in automatic mode</li> <li>■ Automatically measuring workpieces</li> <li>■ Tools can be measured automatically</li> </ul>
------------------------------	-------------------------------------------------------------------------------------------------------------------------------------------------------------------------------------------------------------------------------------------------------------------------------------------------------------------------------------------------------

---

### HEIDENHAIN DNC (option 18)

Communication with external PC applications over COM component

---

### Advanced Programming Features (option 19)

<b>Expanded programming functions</b>	<p><b>FK free contour programming:</b></p> <p>Programming in HEIDENHAIN conversational format with graphic support for workpiece drawings not dimensioned for NC</p>
---------------------------------------	----------------------------------------------------------------------------------------------------------------------------------------------------------------------

---

**Advanced Programming Features (option 19)**

---

**Fixed cycles:**

- Peck drilling, reaming, boring, counterboring, centering (cycles 201 to 205, 208, 240, 241)
  - Milling of internal and external threads (cycles 262 to 265, 267)
  - Finishing of rectangular and circular pockets and studs (cycles 212 to 215, 251 to 257)
  - Clearing level and oblique surfaces (cycles 230 to 233)
  - Straight slots and circular slots (cycles 210, 211, 253, 254)
  - Linear and circular point patterns (cycles 220, 221)
  - Contour train, contour pocket—also with contour-parallel machining, trochoidal slot (cycles 20 to 25, 275)
  - Engraving (cycle 225)
  - OEM cycles (special cycles developed by the machine tool builder) can be integrated
- 

**Advanced Graphic Features (option 20)**

---

**Expanded graphic functions****Program-verification graphics, program-run graphics**

- Plan view
  - Projection in three planes
  - 3-D view
- 

**Advanced Function Set 3 (option 21)**

---

**Expanded functions Group 3****Tool compensation:**

M120: Radius-compensated contour look-ahead for up to 99 blocks

**3-D machining:**

M118: Superimpose handwheel positioning during program run

---

**Pallet Management (option 22)**

---

**Pallet management**

Processing workpieces in any sequence

---

**Display Step (option 23)**

---

**Display step****Input resolution:**

- Linear axes down to 0.01  $\mu\text{m}$
  - Rotary axes to 0.00001°
- 

**CAD Import (option 42)**

---

**CAD import**

- Support for DXF, STEP and IGES
  - Adoption of contours and point patterns
  - Simple and convenient specification of presets
  - Selecting graphical features of contour sections from conversational programs
- 

**KinematicsOpt (option 48)**

---

**Optimizing the machine kinematics**

- Backup/restore active kinematics
  - Test active kinematics
  - Optimize active kinematics
-

---

**Extended Tool Management (option 93)**

**Extended tool management** Python-based

---

**Remote Desktop Manager (option 133)**

**Remote operation of external computer units**

- Windows on a separate computer unit
- Incorporated in the control's interface

---

**Cross Talk Compensation – CTC (option 141)**

**Compensation of axis couplings**

- Determination of dynamically caused position deviation through axis acceleration
- Compensation of the TCP (**T**ool **C**enter **P**oint)

---

**Position Adaptive Control – PAC (option 142)**

**Adaptive position control**

- Changing of the control parameters depending on the position of the axes in the working space
- Changing of the control parameters depending on the speed or acceleration of an axis

---

**Load Adaptive Control – LAC (option 143)**

**Adaptive load control**

- Automatic determination of workpiece weight and frictional forces
- Changing of control parameters depending on the actual mass of the workpiece

---

**Active Chatter Control – ACC (option 145)**

**Active chatter control** Fully automatic function for chatter control during machining

---

**Active Vibration Damping – AVD (option 46)**

**Active vibration damping** Damping of machine oscillations to improve the workpiece surface

---

**Batch Process Manager (option 154)**

**Batch process manager** Planning of production orders

## Feature Content Level (upgrade functions)

Along with software options, significant further improvements of the control software are managed via the **Feature Content Level** upgrade functions. If you install a software update on your control you do not automatically have the functions available as covered by the FCL.



All upgrade functions are available to you without surcharge when you receive a new machine.

Upgrade functions are identified in the manual as **FCL n**. The **n** signifies the serial number of the development status.

You can purchase a code number in order to permanently enable the FCL functions. For more information, contact your machine tool builder or HEIDENHAIN.

## Intended place of operation

The control complies with the limits for a Class A device in accordance with the specifications in EN 55022, and is intended for use primarily in industrially-zoned areas.

## Legal information

This product uses open source software. Further information is available on the control under:

- ▶ **Programming** operating mode
- ▶ MOD function
- ▶ **LICENSE INFO** soft key

## New functions

### New functions 73498x-02

- DXF files can now be opened directly on the control in order to extract contours and point patterns, see "Data Transfer from CAD Files", page 323
- The active tool-axis direction can now be activated as a virtual tool axis in the Manual Operation mode and during handwheel superimpositioning, see "Superimposing handwheel positioning during program run: M118 (software option Miscellaneous functions)", page 481
- Writing and reading data in freely definable tables, see "Freely definable tables", page 518
- New touch probe Cycle 484 for calibrating the wireless touch probe TT 449, see Cycle Programming User's Manual
- The new HR 520 and HR 550 FS handwheels are supported, see "Traverse with electronic handwheels", page 627
- New operating Cycle 225 Engraving, see Cycle Programming User's Manual
- New Active Chatter Control (ACC) software option, see "Active Chatter Control ACC (option 145)", page 498
- New manual probing cycle **Center line as preset**, see "Setting a center line as preset", page 683
- New function for rounding corners, see "Rounding corners: M197", page 488
- External access to the control can now be blocked with an MOD function, see "External access", page 742

**Changed functions 73498x-02**

- The maximum number of characters for the NAME and DOC fields in the tool table has been increased from 16 to 32, see "Entering tool data into the table", page 234
- The columns ACC were added to the tool table, see "Entering tool data into the table", page 234
- Operation and positioning behavior of the manual probing cycles has been improved, see "Using a 3-D touch probe (option 17)", page 654
- Predefined values can now be entered into a cycle parameter with the PREDEF function in cycles, see Cycle Programming User's Manual
- With the KinematicsOpt cycles a new optimization algorithm is now used, see the Cycle Programming User's Manual
- With Cycle 257, CIRCULAR STUD, a parameter is now available with which you can determine the approach position on the stud, see User's Manual for Cycle Programming
- With Cycle 256 RECTANGULAR STUD, a parameter is now available with which you can determine the approach position on the stud, see Cycle Programming User's Manual
- With the manual **Basic Rotation** touch probe cycle, workpiece misalignment can now be compensated for via a table rotation, see "Compensation of workpiece misalignment by rotating the table", page 671

**New functions 81760x-01**

- New special operating mode RETRACT, see "Retraction after a power interruption", page 724
- New graphic simulation, see "Graphics (option 20)", page 700
- New **Tool usage file** MOD function in the machine settings group, see "Tool usage file", page 745
- New **Set system time** MOD function in the systems settings group, see "Set the system time", page 746
- New **Graphic settings** MOD group, see "Graphic settings", page 740
- With the new cutting data calculator you can calculate the spindle speed and the feed rate, see "Cutting data calculator", page 210
- Now you can activate and deactivate the active chatter control (ACC) with a soft key, see "Activating/deactivating ACC", page 499
- With the jump commands new if/then decisions have been introduced, see "Programming if-then decisions", page 377
- The character set of machining Cycle 225 Engraving has been expanded to include more characters and the diameter sign, see Cycle Programming User's Manual
- New machining Cycle 275 Trochoidal Milling, see Cycle Programming User's Manual
- New Cycle 233 Face Milling, see Cycle Programming User's Manual
- In the drilling cycles 200, 203 and 205 the parameter Q395 DEPTH REFERENCE has been introduced in order to evaluate the T ANGLE, see Cycle Programming User's Manual
- Probing Cycle 4 MEASURING IN 3-D has been introduced, see Cycle Programming User's Manual

**Modified functions 81760x-01**

- Up to 4 M functions are now allowed in an NC block, see "Fundamentals", page 468
- New soft keys for transferring values have been introduced in the pocket calculator, see "Operation", page 207
- The distance-to-go display can now also be displayed in the input system, see "Select the position display", page 747
- Several input parameters have been added to Cycle 241 SINGLE-LIP DEEP HOLE DRILLING, see Cycle Programming User's Manual
- Parameter Q305 NUMBER IN TABLE has been added to Cycle 404, see Cycle Programming User's Manual
- In the thread milling cycles 26x an approaching feed rate has been introduced, see Cycle Programming User's Manual
- In Cycle 205 Universal Pecking you can now use parameter Q208 to define a feed rate for retraction, see Cycle Programming User's Manual



**New functions 81760x-02**

- Programs with .HU and .HC extensions can be selected and processed in all operating modes
- The functions **SELECT PROGRAM** and **CALL SELECTED PROGRAM** have been introduced, see "Calling any program as a subprogram", page 353
- New **FEED DWELL** function for programming repeating dwell times, see "Dwell time FUNCTION FEED", page 526
- The FN18 functions have been expanded, see "FN 18: SYSREAD – Reading system data", page 392
- USB data carriers can be locked with the SELinux security software, see "SELinux security software", page 109
- The machine parameter **posAfterContPocket** (no. 201007) that influences positioning after an SL cycle has been introduced, see "Machine-specific user parameters", page 776
- Protective zones can be defined in the MOD menu, see "Entering traverse limits", page 744
- Write protection is possible for individual lines in the preset management, see "Saving presets in the table", page 644
- New manual probing function for aligning a plane, see "Measuring 3-D basic rotation", page 673
- New function for aligning the machining plane without rotary axes, see "Tilting the working plane without rotary axes", page 562
- CAD files can be opened without option number 42, see "Data Transfer from CAD Files", page 323
- New software option 93 Extended Tool Management, see "Calling tool management", page 261

**Modified functions 81760x-02**

- FZ and FU feed rate input possible in the Tool Call block, see "Calling the tool data", page 249
- The input range of the DOC column in the pocket table has been expanded to 32 characters, see "Pocket table for tool changer", page 246
- Commands FN 15, FN 31, FN 32, FT and FMAXT from predecessor controls no longer generate ERROR blocks during import. When simulating or running an NC program with these commands, the control interrupts the NC program with an error message that helps you to find an alternative implementation
- Miscellaneous functions M104, M105, M112, M114, M124, M134, M142, M150, M200 - M204 from predecessor controls no longer generate ERROR blocks during import. When simulating or running an NC program with these miscellaneous functions, the control interrupts the NC program with an error message that helps you to find an alternative implementation, see "Comparison: Miscellaneous functions", page 815
- The maximum file size of files output with FN 16: F-PRINT has been increased from 4 KB to 20 KB
- The Preset.PR preset management is write-protected in Programming operating mode, see "Saving presets in the table", page 644
- The input range of the Q parameter list for defining the QPARA tab on the status display consists of 132 input positions, see "Displaying Q parameters (QPARA tab)", page 99
- Manual calibration of the touch probe with fewer pre-positioning movements, see "Calibrating 3-D touch probes (option 17)", page 663
- The position display takes into account the DL oversizes programmed in the Tool Call block, selectable as an oversize of the workpiece or tool, see "Delta values for lengths and radii", page 233
- In single block mode the control executes each point individually with point pattern cycles and CYCL CALL PAT, see "Program run", page 717
- Rebooting the control is no longer possible with the **END** key but with the **RESTART** soft key, see "Switch-off", page 624
- The control displays the contouring feed rate in manual mode, see "Spindle speed S, feed rate F and miscellaneous function M", page 637
- Deactivate tilting in manual mode is only possible via the 3D-ROT menu, see "Activating manual tilting:", page 690
- Machine parameter **maxLineGeoSearch** (no. 105408) has been increased to max. 50000, see "Machine-specific user parameters", page 776
- The names of software options number 8, 9 and 21 have changed, see "Software options", page 9

**New and modified cycle functions 81760x-02**

- New cycle **239 ASCERTAIN THE LOAD** for LAC (Load Adapt. Control) load-dependent adaptation of control parameters (option 143)
- Cycle **270 CONTOUR TRAIN DATA** has been added (option 19)
- Cycle **39 CYL. SURFACE CONTOUR** has been added (option 1)
- The character set of machining cycle **225 ENGRAVING** has been expanded with the CE character, ß, the @ character and system time
- Cycles **252-254** (option 19) have been expanded with the optional parameter Q439
- Cycle **22 ROUGH-OUT** (option 19) has been expanded by the optional parameters Q401, Q404
- Cycle **484 CALIBRATE IR TT** (option 17) has been expanded by the optional parameter Q536

**Further information:** Cycle Programming User's Manual

**New functions 81760x-03**

- Manual probe functions create a line in the preset table that does not yet exist, see "Writing measured values from the touch-probe cycles to the preset table", page 662
- Manual probe functions can write in a password-protected line, see "Recording measured values from the touch probe cycles", page 660
- The column **KINEMATIC** has been added to the tool table, see "Entering tool data into the table", page 234
- When importing tool data the CSV file may contain additional table columns not recognized by the control. During import a message is displayed indicating the unrecognized columns and informing that these values will not be adopted, see "Importing and exporting tool data", page 268
- New function **FUNCTION S-PULSE** for programming pulsing shaft speeds, see "Pulsing spindle speed FUNCTION S-PULSE", page 524
- It is possible to search quickly for a file in file management by entering the first letter, see "Selecting drives, directories and files", page 174
- With active structuring the structure block can be edited in the structure window, see "Definition and applications", page 205
- The FN18 functions have been expanded, see "FN 18: SYSREAD – Reading system data", page 392
- The control differentiates between interrupted or stopped NC programs. In the interrupted status, the control offers more intervention options, see "Interrupting, stopping or aborting machining", page 719
- Animated help can be selected with the tilt working plane function, see "Overview", page 537
- The software option number 42 DXF Converter now also produces CR circles, see "Basic settings", page 327

**Modified functions 81760x-03**

- When editing the tool table or tool management, only the current table line is blocked, see "Editing the tool table", page 240
- When importing tool tables, nonexistent tool types are imported as type undefined, see "Importing tool tables", page 243
- You cannot delete the tool data of tools still stored in the pocket table, see "Editing the tool table", page 240
- In all manual probing functions, quicker selection of the start angle of holes and studs is possible with soft keys (paraxial probing directions), see "Functions in touch probe cycles", page 657
- When probing, after acceptance of the actual value of the 1st point for the 2nd point the soft key for the axis direction is shown
- In all manual probing functions, the direction of the reference axis is suggested as a default
- In manual probing cycles the hard keys **END** and **Adopt Actual Position** may be used
- The display of the machining feed rate has been changed in manual mode, see "Spindle speed S, feed rate F and miscellaneous function M", page 637
- In the file management, the programs or directories at the cursor position are also displayed in a separate field beneath the current path display
- Block editing no longer causes block marking to be canceled. If a block is edited with active block marking and another block is then selected via the syntax search, the marking is expanded to the newly selected block, see "Marking, copying, cutting and inserting program sections", page 165
- In the screen layout **PROGRAM + SECTS** it is possible to edit the structure in the structure window, see "Definition and applications", page 205
- The functions **APPR CT** and **DEP CT** allow approach to and departure from a helix. This movement is carried out as a helix with an even pitch, see "Overview: Types of paths for contour approach and departure", page 280
- The functions **APPR LT**, **APPR LCT**, **DEP LT** and **DEP LCT** position all three axes at on the auxiliary point at the same time, see "Approaching on a straight line with tangential connection: APPR LT", page 283, see "Approaching on a circular path with tangential connection from a straight line to the contour: APPR LCT", page 285
- The values entered for the traverse limits are checked for validity, see "Entering traverse limits", page 744
- When calculating the axis angle in the axes chosen with M138, the control sets the value to 0, see "Selecting tilting axes: M138", page 571
- The input range in columns SPA, SPB and SPC of the preset table was expanded to 999.9999, see "Managing presets", page 644
- Tilting is permitted in combination with mirroring, see "The PLANE function: Tilting the working plane (option 8)", page 535

- Even when the 3D-ROT dialog is active in Manual Operation mode, **PLANE RESET** still functions with active basic transformation, see "Activating manual tilting:", page 690
- The feed rate potentiometer only reduces the programmed feed rate and no longer the feed rate calculated by the control, see "Feed rate F", page 230
- The DXF converter displays **FUNCTION MODE TURN** or **FUNCTION MODE MILL** as a comment

#### **New and modified cycle functions 81760x-03**

- New cycle 258 POLYGON STUD (option 19)
- Cycles 421, 422 and 427 have been expanded to include parameters Q498 and Q531
- In Cycle 247 PRESETTING, the preset number from the preset table can be selected with the corresponding parameter
- Cycles 200 and 203: The behavior of the dwell time at top was modified,
- Cycle 205 performs deburring on the coordinate surface
- With SL cycles, M110 is now taken into account with circles compensated inwards if it is active during machining

**Further information:** Cycle Programming User's Manual

**New functions 81760x-04**

- New function **FUNCTION DWELL** for programming a dwell time, see "Dwell time FUNCTION DWELL", page 528
- The column **OVRTIME** has been added to the tool table, see "Entering tool data into the table", page 234
- During a manual touch probe cycle, control can be transferred to the handwheel, see "Traverse movements with a handwheel with display", page 656
- Several handwheels can be connected to a control, see "Traverse with electronic handwheels", page 627
- In **Electronic handwheel** mode of operation, the handwheel axis for an HR 130 can be selected with the orange axis keys
- If the control is set to the INCH unit of measure, the control also includes movements traversed by the handwheel in INCHES, see "Traverse with electronic handwheels", page 627
- The FN18 functions have been expanded, see "FN 18: SYSREAD – Reading system data", page 392
- The FN16 functions have been expanded, see "FN16: F-PRINT – Formatted output of texts and Q parameter values", page 385
- The file saved with **SAVE AS** is now also found in the file management under **LAST FILES**, see "Editing an NC program", page 162
- If you save files with **SAVE AS**, you can select the target directory with the **SWITCH** soft key, see "Editing an NC program", page 162
- File management displays vertical scrollbars and supports scrolling with the mouse, see "Calling the file manager", page 173
- New machine parameter for recreating **M7** and **M8**, see "Machine-specific user parameters", page 776
- New machine parameter for deactivating parallel axis programming, see "Working with the parallel axes U, V and W", page 500
- The function **STRLEN** checks whether a string parameter has been defined, see "Finding the length of a string parameter", page 451
- The function **SYSSTR** enables the NC software version to be read out, see "Reading system data", page 448
- The function **FN 38: SEND** can now be programmed without a code number
- Undefined Q parameters can now be transferred with the function **FN 0**
- For jumps with **FN 9**, QS parameters and texts are permitted as conditions, see "Programming if-then decisions", page 377
- Cylindrical workpiece blanks can now also be defined with a diameter instead of a radius, see "Defining the blank: BLK FORM", page 155
- Programming of **TCPM AXIS SPAT** is possible with active Cycle 8 and Cycle 10
- The transitional elements **RND** and **CHF** can now also be executed between 3-D contours, i.e. with straight line blocks with three programmed coordinates or a helix

- The control now supports spatial arcs, i.e. circles in 3 axes vertical to the working plane, see "Circular path C around circle center CC", page 293
- Active kinematics is displayed in the 3D-ROT menu, see "Activating manual tilting:", page 690
- In operating modes **Program run, single block** and **Program run, full sequence** the screen layout **PROGRAM + SECTS** can be specified, see "Structuring programs", page 205
- In operating modes **Program Run Full Sequence, Program Run Single Block** and **Positioning w/ Manual Data Input**, the font size can be set to the same size as the **Programming** operating mode, see "Machine-specific user parameters", page 776
- The functions in the **Positioning w/ Manual Data Input** mode were expanded and adapted for improved operation, see "Positioning with Manual Data Input", page 693
- Active kinematics is displayed in the operating mode **RETRACT**, see "Retraction after a power interruption", page 724
- In the **RETRACT** operating mode, feed-rate limitation can be deactivated with the **CANCEL THE FEED RATE LIMITATION** soft key, see "Retraction after a power interruption", page 724
- In the **Test Run** operating mode a tool usage file can also be created without simulation, see "Tool usage test", page 254
- In the **Test Run** operating mode you can hide the rapid traverse movements with the **FMAX PATHS** soft key, see "3-D view in the Test Run operating mode", page 704
- In the **Test Run** operating mode you can reset the solid-model view with the **RESET THE VOLUME MODEL** soft key, see "3-D view in the Test Run operating mode", page 704
- In the **Test Run** operating mode you can reset the tool paths with the **RESET TOOL PATHS** soft key, see "3-D view in the Test Run operating mode", page 704
- In the **Test Run** operating mode the **MEASURING** soft key displays the coordinates if you position the mouse on the graphics, see "3-D view in the Test Run operating mode", page 704
- In the **Test Run** operating mode the **STOP AT** soft key simulates up to a predefined block, see "Test Run up to a certain block ", page 716
- Active basic transformation is shown in the status display on the **POS** tab, see "Positions and coordinates (POS tab)", page 98
- The status display now also shows the path of the active main program, see "Overview", page 96, see "General program information (PGM tab)", page 97
- In the status display the **CYC** tab now also shows **T-Max** and **TA-Max**
- Mid-program startup can now be continued, see "Entering the program at any point: Mid-program startup", page 727
- With functions **NC/PLC Backup** and **NC/PLC Restore** you can save and restore single directories or the complete TNC drive, see "Backup and restore", page 112
- Touchscreens operation is supported, see "Operating the Touchscreen", page 123



**Modified functions 81760x-04**

- Tool names can now also include the special characters % and , , see "Tool number, tool name", page 232
- When importing tool tables the numerical values are adopted from the **R-OFFS** column, see "Importing tool tables", page 243
- In the **LIFTOFF** column of the tool table the default is now **N**, see "Entering tool data into the table", page 234
- The **L** and **R** columns of the tool table are empty when a new tool is created, see "Editing the tool table", page 240
- In the tool table, the **SELECT** soft key is now available for the **RT** and **KINEMATIC** columns, see "Entering tool data into the table", page 234
- The touch probe function Corner as preset has been expanded, see "Corner as preset", page 678
- The arrangement of soft keys in the manual probing cycle **PROBING P** has been adapted, see "Corner as preset", page 678
- The **FMAX** soft key in Program Run not only limits the machining feed rate during execution of the program but also the axis feed rate for manual axis movements, see "Feed rate limit F MAX", page 638
- Soft key allocations were adapted for incremental positioning
- When the preset management is opened, the cursor is on the line of the active preset
- New help graphics with **PLANE RESET**, see "Specifying the positioning behavior of the PLANE function", page 554
- The behavior of **COORD ROT** and **TABLE ROT** in the 3D-ROT menu has been modified, see "Specifying the positioning behavior of the PLANE function", page 554
- The current structure block can be more clearly recognized in the structure window, see "Definition and applications", page 205
- DHCP Lease Time is now also valid following power interruption. When HEROS is shut down, the DHCP server is no longer informed that the IP address is free again, see "Configuring the control", page 757
- In the status display the fields for the LBL names have been expanded to 32 characters
- The **TT** status display now also shows values if the user changes to the **TT** tab later
- Status displays can now also be switched over with the **Next tab** key, see "Additional status displays", page 96
- An active pallet table during program run can only be edited via the **EDIT PALLET** soft key, see "Processing pallet table", page 603
- If a subprogram called with **CALL PGM** ends with **M2** or **M30** the control outputs a warning
- **M124** no longer triggers an error message but only a warning. This enables NC programs with programmed **M124** to run through without interruption
- Upper and lower cases for a file name can be modified in the file management

- If a larger file is transferred to a USB device in the file management, the control displays a warning until file transfer is completed, see "USB devices on the control", page 197
- In the file management, the control also shows the momentary type filter with the path
- In the file management the **SHOW ALL** soft key is now displayed in all operating modes
- In the file management the function **Select the target directory** was modified for copying files or directories. The soft keys **OK** and **CANCEL** are available on the first two positions
- The colors of the programming graphics were changed, see "Programming graphics", page 212
- In the **Test Run** and **Programming** operating modes the tool data is reset when a program is reselected or restarted with the **RESET + START** soft key
- In the **Test Run** operating mode the control displays the datum of the machine table as the reference point when using **BLANK IN WORK SPACE**, see "Showing the workpiece blank in the working space (option 20)", page 710
- After modification of the active preset, resuming the program is only possible after **GOTO** or mid-program startup, see "Moving the machine axes during an interruption", page 722
- With mid-program startup an FK sequence can be entered, see "Entering the program at any point: Mid-program startup", page 727
- Mid-program startup operation and dialog guidance has been improved, also for pallet tables, see "Entering the program at any point: Mid-program startup", page 727

#### **New and modified cycle functions 81760x-04**

- With Cycle 251 Rectangular pocket, **M110** is now taken into account with circles compensated inwards if it is active during machining
- In the protocol of the KinematicsOpt cycles 451 and 452 the position of the measured rotary axes can be output before and after optimization. (Software option 52)
- Cycle 225 has been expanded with parameters Q516, Q367 and Q574. This enables a preset for the specific text position to be defined or the text length and character height to be scaled
- In Cycles 481 to 483, parameter Q340 was expanded with the input option "2". This makes it possible to check the tool without changing the tool table
- Cycle 251 has been expanded by parameter Q439. The finishing strategy was also revised
- The finishing strategy was revised with cycle 252
- Cycle 275 has been expanded with parameters Q369 and Q439

**Further information:** Cycle Programming User's Manual

### New functions 81760x-05

- The new **Batch Process Manager** function enables you to plan production orders, **Further information:** "Batch Process Manager", page 611
- New **FUNCTION PROG PATH** function for taking the entire tool radius into account in 3-D radius compensation, see "Interpretation of the programmed path", page 588
- When an application is active on the third or fourth desktop, the operating mode keys are also effective with touch operation, see "Save elements and switch to the NC program", page 135
- The **TCPM** function (option 9) was expanded by the selection of the tool reference point and the center of rotation, see "Selection of tool reference point and center of rotation", page 577
- New tool-oriented pallet machining function, see "Tool-oriented machining", page 606
- New pallet preset management, see "Pallet preset management", page 605
- If a pallet table is selected in a Program Run operating mode, the **Tooling list** and **T usage order** are calculated for the entire pallet table, see "Tool management (option number 93)", page 260
- New **FUNCTION COUNT** function for controlling a counter, see "Defining a counter", page 512
- New **FUNCTION LIFTOFF** function for retracting the tool from the contour upon an NC stop, see "Lift off tool at NC stop: FUNCTION LIFTOFF", page 529
- You can also open the tool-carrier files in the file management, see "Tool carrier management", page 493
- With the **ADAPT NC PGM / TABLE** function, you can also import and modify freely definable tables, see "Importing tool tables", page 243
- The machine tool builder can define update rules that make it possible, for example, to automatically remove umlauts from tables and NC programs when importing a table, see "Importing tool tables", page 243
- A quick search for the tool name is possible in the tool table, see "Entering tool data into the table", page 234
- It is possible to comment out NC blocks, see "Commenting out an existing NC block", page 201
- The machine tool builder can disable the setting of presets in individual axes, see "Saving presets in the table", page 644, see "Presetting with a 3-D touch probe (option number 17)", page 676
- Line 0 of the preset table can also be edited manually, see "Saving presets in the table", page 644
- The CAD viewer exports points with **FMAX** to an H file, see "Selecting the file type", page 338
- When multiple instances of the CAD viewer are open, they are shown somewhat smaller on the third desktop.
- The CAD viewer now enables you to extract data from STEP, IGES and STEP files, see "Data Transfer from CAD Files", page 323

- The nodes in all tree structures can be expanded and collapsed by double-clicking them.
- New icon in the status display for mirrored machining, see "General status display", page 94
- Graphic settings in the **Test Run** operating mode are permanently stored, see "3-D view in the Test Run operating mode", page 704
- In the **Test Run** operating mode, you can now choose between various traverse ranges, see "Application", page 710
- The tool data of touch probes can also be displayed and entered in the tool management (option 93), see "Editing tool management", page 262
- New MOD dialog for managing radio touch probes, see "Set up touch probes", page 766
- With the **TCH PROBE MONITOR OFF** soft key you can suppress touch-probe monitoring for 30 seconds, see "Suppress touch probe monitoring", page 657
- During manual probing **ROT** and **P**, workpiece misalignment can be compensated by aligning a rotary table, see "Compensation of workpiece misalignment by rotating the table", page 671, see "Corner as preset", page 678
- If the function for orienting the touch probe to the programmed probe direction is active, the number of spindle revolutions is limited when the guard door is open. In some cases, the direction of spindle rotation will change so that positioning will not always follow the shortest path.
- With FN 16: F-PRINT, it is possible to enter references to Q parameters or QS parameters as the source and target, see "FN16: F-PRINT – Formatted output of texts and Q parameter values", page 385
- The FN18 functions have been expanded, see "FN 18: SYSREAD – Reading system data", page 392
- New machine parameter **iconPrioList** (no. 100813) for defining the order of icons in the status display, see "Machine-specific user parameters", page 776
- The machine parameter **clearPathAtBlk** (no. 124203) enables you to specify whether the tool paths will be cleared with a new BLK FORM in the **Test Run** operating mode, see "Machine-specific user parameters", page 776
- New optional machine parameter **CfgDisplayCoordSys** (no. 127500) for selecting the coordinate system in which a datum shift is to be shown in the status display, see "Machine-specific user parameters", page 776
- The control supports up to 8 control loops, including a maximum of two spindles.

**Modified functions 81760x-05**

- If you use locked tools, the control displays a warning in the **Programming** and **Test Run** operating modes, see "Programming graphics", page 212, see "Test run", page 713
- The **M94** miscellaneous function is effective for all rotary axes that are not limited by software limit switches or traverse limits, see "Reducing display of a rotary axis to a value less than 360°: M94", page 567
- The control offers a positioning logic for returning to the contour, see "Returning to the contour", page 733
- The positioning logic for returning to the contour with a replacement tool has changed, see "Tool change", page 251
- If the control finds a stored interruption point on restart, you can resume the machining operation from that point, see "Entering the program at any point: Mid-program startup", page 727
- Axes that are not active in the current kinematic model can also be referenced in a tilted working plane, see "Crossing the reference point in a tilted working plane", page 623
- The **TRANS DATUM AXIS** NC syntax can also be used within a contour in the SL cycle.
- Holes and threads are shown in light blue in the programming graphics, see "Programming graphics", page 212
- The tool is shown in red in the graphics while it is in contact with the workpiece, and blue during air cuts, see "Tool display", page 708
- The positions of the sectional planes are no longer reset when a program or a new blank form is selected, see "Projection in three planes", page 706
- Spindle speeds can be entered with decimal places also in the **Manual operation** mode. The control displays the decimal places when the spindle speed is < 1000, see "Entering values", page 637
- The sort order and the column widths in the tool selection window are retained when the control is switched off, see "Calling the tool data", page 249
- If a file to be deleted does not exist, **FILE DELETE** no longer generates an error message.
- If a subprogram called with CALL PGM ends with **M2** or **M30**, the control issues a warning. The control automatically clears the warning as soon as you select another NC program, see "Programming notes", page 352
- The control displays an error message in the header until it is cleared or replaced by a higher-priority error, see "Display of errors", page 216
- The time needed to paste a large amount of data into an NC program was considerably reduced.
- To connect a USB stick you no longer have to press a soft key, see "Connecting and removing USB storage devices", page 183
- The speed of setting the jog increment, spindle speed and feed rate was adjusted for electronic handwheels.

- The icons of basic rotation, 3-D basic rotation and tilted working plane were modified to make them easier to distinguish, see "General status display", page 94
- The icon for **FUNCTION TCPM** was modified, see "General status display", page 94
- The control automatically recognizes whether a table is to be imported or the table format is to be adapted, see "Importing tool tables", page 243
- When you place the cursor in an input field of the tool management, the entire input field is highlighted.
- When you double-click a selection field of the table editor with the mouse or press the **ENT** key, a pop-up window opens.
- When configuration subfiles are modified, the control no longer aborts the test run, but only displays a warning.
- You can neither set nor modify a preset without having referenced the axes, see "Traverse reference points", page 622
- The control issues a warning if the handwheel potentiometers are still active when the handwheel is deactivated, see "Traverse with electronic handwheels", page 627
- When using the HR 550 or HR 550FS handwheels, a warning is issued if the battery voltage is too low, see "Traverse with electronic handwheels", page 627
- The machine tool builder can define whether the **R-OFFS** offset will be taken into account for a tool with **CUT 0**, see "Tool table: Tool data required for automatic tool measurement", page 239
- The machine tool builder configures whether the control will take the axis angle into account or set it to 0 for the axes specified in **M138**, see "Selecting tilting axes: M138", page 571
- The machine tool builder can change the simulated tool change position, see "Test run", page 713
- **LN** blocks are evaluated with a high accuracy, regardless of option 23.
- The **SYSSTR** function can be used to read the path of pallet programs, see "Reading system data", page 448
- In the machine parameter **decimalCharakter** (no. 100805) you can define whether a period or a comma will be used as the decimal separator, see "Machine-specific user parameters", page 776

**New and modified cycle functions 81760x-05**

- New Cycle 441 **FAST PROBING**. With this cycle you can set various touch probe parameters (e.g. positioning feed rate) that are globally effective for all subsequently used touch probe cycles.
- Cycles 256 **RECTANGULAR STUD** and 257 **CIRCULAR STUD** were extended by the parameters Q215, Q385, Q369 and Q386.
- Cycle 239 ascertains the current load of the machine axes with the LAC control function. In addition, Cycle 239 can now also adjust the maximum axis acceleration. Cycle 239 supports the determination of the load on synchronized axes.
- The feed rate behavior in Cycles 205 and 241 was changed.
- Changes of details in Cycle 233: Monitors the tooth length (**LCUTS**) during finishing, increases the area by Q357 in the milling direction when roughing with milling strategies 0 to 3 (provided that no limit has been set in the milling direction)
- The technologically outdated Cycles 1, 2, 3, 4, 5, 17, 212, 213, 214, 215, 210, 211, 230, and 231 grouped under **OLD CYCLES** can no longer be inserted using the editor. These cycles can still be executed and edited, however.
- The tool touch probe cycles, such as Cycles 480, 481 and 482, can be hidden
- Cycle 225 Engraving can engrave the current counter reading by using a new syntax.
- New SERIAL column in the touch probe table
- Enhancement of the contour train: Cycle 25 with Residual Material Machining, Cycle 276 Three-D Contour Train

**Further information:** Cycle Programming User's Manual



## Contents

<b>1</b>	<b>First Steps with the TNC 620.....</b>	<b>63</b>
<b>2</b>	<b>Introduction.....</b>	<b>87</b>
<b>3</b>	<b>Operating the Touchscreen.....</b>	<b>123</b>
<b>4</b>	<b>Fundamentals, File Management.....</b>	<b>139</b>
<b>5</b>	<b>Programming Aids.....</b>	<b>199</b>
<b>6</b>	<b>Tools.....</b>	<b>229</b>
<b>7</b>	<b>Programming Contours.....</b>	<b>271</b>
<b>8</b>	<b>Data Transfer from CAD Files.....</b>	<b>323</b>
<b>9</b>	<b>Subprograms and Program Section Repeats.....</b>	<b>345</b>
<b>10</b>	<b>Programming Q Parameters.....</b>	<b>365</b>
<b>11</b>	<b>Miscellaneous Functions.....</b>	<b>467</b>
<b>12</b>	<b>Special Functions.....</b>	<b>489</b>
<b>13</b>	<b>Multiple-Axis Machining.....</b>	<b>533</b>
<b>14</b>	<b>Pallet Management.....</b>	<b>597</b>
<b>15</b>	<b>Batch Process Manager.....</b>	<b>611</b>
<b>16</b>	<b>Manual Operation and Setup.....</b>	<b>619</b>
<b>17</b>	<b>Positioning with Manual Data Input.....</b>	<b>693</b>
<b>18</b>	<b>Test Run and Program Run.....</b>	<b>699</b>
<b>19</b>	<b>MOD Functions.....</b>	<b>737</b>
<b>20</b>	<b>Tables and Overviews.....</b>	<b>775</b>



<b>1</b>	<b>First Steps with the TNC 620.....</b>	<b>63</b>
<b>1.1</b>	<b>Overview.....</b>	<b>64</b>
<b>1.2</b>	<b>Machine switch-on.....</b>	<b>64</b>
	Acknowledging the power interruption and moving to the reference points.....	64
<b>1.3</b>	<b>Programming the first part.....</b>	<b>66</b>
	Selecting the correct operating mode.....	66
	The most important control keys.....	66
	Opening a new program/file management.....	67
	Defining a workpiece blank.....	68
	Program layout.....	69
	Programming a simple contour.....	71
	Creating a cycle program.....	74
<b>1.4</b>	<b>Graphically testing the first part (option 20).....</b>	<b>77</b>
	Selecting the correct operating mode.....	77
	Selecting the tool table for the test run.....	77
	Choosing the program you want to test.....	78
	Selecting the screen layout and the view.....	78
	Starting the test run.....	79
<b>1.5</b>	<b>Setting up tools.....</b>	<b>80</b>
	Selecting the correct operating mode.....	80
	Preparing and measuring tools.....	80
	The tool table TOOL.T.....	81
	The pocket table TOOL_PTCH.....	82
<b>1.6</b>	<b>Workpiece setup.....</b>	<b>83</b>
	Selecting the correct operating mode.....	83
	Clamping the workpiece.....	83
	Presetting with a 3-D touch probe (option number 17).....	84
<b>1.7</b>	<b>Running the first program.....</b>	<b>85</b>
	Selecting the correct operating mode.....	85
	Choosing the program you want to run.....	85
	Starting the program.....	85

<b>2</b>	<b>Introduction.....</b>	<b>87</b>
<b>2.1</b>	<b>The TNC 620.....</b>	<b>88</b>
	HEIDENHAIN Klartext and DIN/ISO.....	88
	Compatibility.....	88
<b>2.2</b>	<b>Visual display unit and operating panel.....</b>	<b>89</b>
	Display screen.....	89
	Setting screen layout.....	90
	Control panel.....	90
<b>2.3</b>	<b>Modes of operation.....</b>	<b>91</b>
	Manual Operation and El. Handwheel.....	91
	Positioning with Manual Data Input.....	91
	Programming.....	92
	Test Run.....	92
	Program Run, Full Sequence and Program Run, Single Block.....	93
<b>2.4</b>	<b>Status displays.....</b>	<b>94</b>
	General status display.....	94
	Additional status displays.....	96
<b>2.5</b>	<b>Window manager.....</b>	<b>100</b>
	Overview of taskbar.....	101
	Portscan.....	104
	Remote Service.....	105
	Printer.....	107
	SELinux security software.....	109
	VNC.....	110
	Backup and restore.....	112
<b>2.6</b>	<b>Remote Desktop Manager (option 133).....</b>	<b>115</b>
	Introduction.....	115
	Configuring connections – Windows Terminal Service (RemoteFX).....	116
	Configuring the connection – VNC.....	118
	Shutting down or rebooting an external computer.....	119
	Starting and stopping the connection.....	120
<b>2.7</b>	<b>Accessories: HEIDENHAIN 3-D touch probes and electronic handwheels.....</b>	<b>121</b>
	3-D touch probes (Touch Probe Functions software option).....	121
	HR electronic handwheels.....	122

<b>3</b>	<b>Operating the Touchscreen.....</b>	<b>123</b>
<b>3.1</b>	<b>Display unit and operation.....</b>	<b>124</b>
	Touchscreen.....	124
	Operating panel.....	125
<b>3.2</b>	<b>Gestures.....</b>	<b>127</b>
	Overview of possible gestures.....	127
	Navigating in the table and NC programs.....	128
	Operating the simulation.....	129
	Using the HEROS menu.....	130
	Operating the CAD viewer.....	131
<b>3.3</b>	<b>Functions in the taskbar.....</b>	<b>136</b>
	Icons of the taskbar.....	136
	Touchscreen Calibration.....	137
	Touchscreen Configuration.....	137
	Touchscreen Cleaning.....	138

<b>4</b>	<b>Fundamentals, File Management.....</b>	<b>139</b>
<b>4.1</b>	<b>Fundamentals.....</b>	<b>140</b>
	Position encoders and reference marks.....	140
	Reference systems.....	141
	Designation of the axes on milling machines.....	151
	Polar coordinates.....	151
	Absolute and incremental workpiece positions.....	152
	Selecting the preset.....	153
<b>4.2</b>	<b>Creating and writing programs.....</b>	<b>154</b>
	Structure of an NC program in HEIDENHAIN Klartext.....	154
	Defining the blank: BLK FORM.....	155
	Creating a new NC program.....	158
	Programming tool movements in Klartext.....	159
	Actual position capture.....	161
	Editing an NC program.....	162
	The control's search function.....	166
<b>4.3</b>	<b>File management: Basics.....</b>	<b>168</b>
	Files.....	168
	Displaying externally generated files on the control.....	170
	Data backup.....	170
<b>4.4</b>	<b>Working with the file manager.....</b>	<b>171</b>
	Directories.....	171
	Paths.....	171
	Overview: Functions of the file manager.....	172
	Calling the file manager.....	173
	Selecting drives, directories and files.....	174
	Creating a new directory.....	176
	Creating new file.....	176
	Copying a single file.....	176
	Copying files into another directory.....	177
	Copying a table.....	178
	Copying a directory.....	179
	Choosing one of the last files selected.....	179
	Deleting a file.....	179
	Deleting a directory.....	180
	Tagging files.....	181
	Renaming a file.....	182
	Sorting files.....	182
	Additional functions.....	183
	Additional tools for management of external file types.....	184
	Additional tools for ITCs.....	192
	Data transfer to or from an external data carrier.....	194

The control in a network.....	196
USB devices on the control.....	197

<b>5</b>	<b>Programming Aids.....</b>	<b>199</b>
<b>5.1</b>	<b>Screen keypad.....</b>	<b>200</b>
	Entering text with the screen keyboard.....	200
<b>5.2</b>	<b>Adding comments.....</b>	<b>201</b>
	Application.....	201
	Entering comments during programming.....	201
	Inserting comments after program entry.....	201
	Entering a comment in a separate block.....	201
	Commenting out an existing NC block.....	201
	Functions for editing of the comment.....	202
<b>5.3</b>	<b>Freely editing an NC program.....</b>	<b>203</b>
<b>5.4</b>	<b>Display of NC programs.....</b>	<b>204</b>
	Syntax highlighting.....	204
	Scrollbar.....	204
<b>5.5</b>	<b>Structuring programs.....</b>	<b>205</b>
	Definition and applications.....	205
	Displaying the program structure window / Changing the active window.....	205
	Inserting a structure block in the program window.....	206
	Selecting blocks in the program structure window.....	206
<b>5.6</b>	<b>Calculator.....</b>	<b>207</b>
	Operation.....	207
<b>5.7</b>	<b>Cutting data calculator.....</b>	<b>210</b>
	Application.....	210
<b>5.8</b>	<b>Programming graphics.....</b>	<b>212</b>
	Activating and deactivating programming graphics.....	212
	Generating a graphic for an existing program.....	213
	Block number display ON/OFF.....	214
	Erasing the graphic.....	214
	Showing grid lines.....	214
	Magnification or reduction of details.....	215
<b>5.9</b>	<b>Error messages.....</b>	<b>216</b>
	Display of errors.....	216
	Opening the error window.....	216
	Closing the error window.....	216
	Detailed error messages.....	217
	INTERNAL INFO soft key.....	217
	FILTER soft key.....	217
	Clearing errors.....	218



Error log.....	218
Keystroke log.....	219
Informational texts.....	220
Saving service files.....	220
Calling the TNCguide help system.....	220
<b>5.10 TNCguide context-sensitive help system.....</b>	<b>221</b>
Application.....	221
Working with TNCguide.....	222
Downloading current help files.....	226

<b>6 Tools.....</b>	<b>229</b>
<b>6.1 Entering tool-related data.....</b>	<b>230</b>
Feed rate F.....	230
Spindle speed S.....	231
<b>6.2 Tool data.....</b>	<b>232</b>
Requirements for tool compensation.....	232
Tool number, tool name.....	232
Tool length L.....	232
Tool radius R.....	232
Delta values for lengths and radii.....	233
Entering tool data into the NC program.....	233
Entering tool data into the table.....	234
Importing tool tables.....	243
Overwriting tool data from an external PC.....	245
Pocket table for tool changer.....	246
Calling the tool data.....	249
Tool change.....	251
Tool usage test.....	254
<b>6.3 Tool compensation.....</b>	<b>256</b>
Introduction.....	256
Tool length compensation.....	256
Tool radius compensation.....	257
<b>6.4 Tool management (option number 93).....</b>	<b>260</b>
Basics.....	260
Calling tool management.....	261
Editing tool management.....	262
Available tool types.....	266
Importing and exporting tool data.....	268

<b>7</b>	<b>Programming Contours.....</b>	<b>271</b>
<b>7.1</b>	<b>Tool movements.....</b>	<b>272</b>
	Path functions.....	272
	FK free contour programming (option 19).....	272
	Miscellaneous functions M.....	272
	Subprograms and program section repeats.....	273
	Programming with Q parameters.....	273
<b>7.2</b>	<b>Fundamentals of path functions.....</b>	<b>274</b>
	Programming tool movements for workpiece machining.....	274
<b>7.3</b>	<b>Approaching and departing a contour.....</b>	<b>278</b>
	Starting point and end point.....	278
	Overview: Types of paths for contour approach and departure.....	280
	Important positions for approach and departure.....	281
	Approaching on a straight line with tangential connection: APPR LT.....	283
	Approaching on a straight line perpendicular to the first contour point: APPR LN.....	283
	Approaching on a circular path with tangential connection: APPR CT.....	284
	Approaching on a circular path with tangential connection from a straight line to the contour: APPR LCT.....	285
	Departing in a straight line with tangential connection: DEP LT.....	286
	Departing in a straight line perpendicular to the last contour point: DEP LN.....	286
	Departing on a circular path with tangential connection: DEP CT.....	287
	Departing on a circular arc tangentially connecting the contour and a straight line: DEP LCT.....	287
<b>7.4</b>	<b>Path contours — Cartesian coordinates.....</b>	<b>288</b>
	Overview of path functions.....	288
	Straight line L.....	289
	Inserting a chamfer between two straight lines.....	290
	Rounded corners RND.....	291
	Circle center CC.....	292
	Circular path C around circle center CC.....	293
	Circle CR with defined radius.....	294
	Circle CT with tangential connection.....	296
	Example: Linear movements and chamfers with Cartesian coordinates.....	297
	Example: Circular movements with Cartesian coordinates.....	298
	Example: Full circle with Cartesian coordinates.....	299
<b>7.5</b>	<b>Path contours – Polar coordinates.....</b>	<b>300</b>
	Overview.....	300
	Datum for polar coordinates: pole CC.....	301
	Straight line LP.....	301
	Circular path CP around pole CC.....	302
	Circle CTP with tangential connection.....	302
	Helix.....	303

Example: Linear movement with polar coordinates..... 305  
 Example: Helix..... 306

**7.6 Path contours – FK free contour programming (option 19).....307**  
 Fundamentals..... 307  
 FK programming graphics..... 309  
 Initiating the FK dialog..... 310  
 Pole for FK programming..... 310  
 Free straight line programming..... 311  
 Free circular path programming..... 312  
 Input possibilities..... 313  
 Auxiliary points..... 316  
 Relative data..... 317  
 Example: FK programming 1..... 319  
 Example: FK programming 2..... 320  
 Example: FK programming 3..... 321

<b>8</b>	<b>Data Transfer from CAD Files.....</b>	<b>323</b>
<b>8.1</b>	<b>Screen layout of the CAD viewer.....</b>	<b>324</b>
	Fundamentals of the CAD viewer.....	324
<b>8.2</b>	<b>CAD import (option 42).....</b>	<b>325</b>
	Application.....	325
	Using the CAD viewer.....	326
	Opening the CAD file.....	326
	Basic settings.....	327
	Setting layers.....	329
	Setting a preset.....	330
	Defining the datum.....	332
	Selecting and saving a contour.....	335
	Selecting and saving machining positions.....	338

<b>9</b>	<b>Subprograms and Program Section Repeats.....</b>	<b>345</b>
<b>9.1</b>	<b>Labeling subprograms and program section repeats.....</b>	<b>346</b>
	Label.....	346
<b>9.2</b>	<b>Subprograms.....</b>	<b>347</b>
	Operating sequence.....	347
	Programming notes.....	347
	Programming the subprogram.....	348
	Calling a subprogram.....	348
<b>9.3</b>	<b>Program-section repeats.....</b>	<b>349</b>
	Label.....	349
	Operating sequence.....	349
	Programming notes.....	349
	Programming a program section repeat.....	350
	Calling a program section repeat.....	350
<b>9.4</b>	<b>Any desired NC program as subprogram.....</b>	<b>351</b>
	Overview of the soft keys.....	351
	Operating sequence.....	352
	Programming notes.....	352
	Calling any program as a subprogram.....	353
<b>9.5</b>	<b>Nesting.....</b>	<b>356</b>
	Types of nesting.....	356
	Nesting depth.....	356
	Subprogram within a subprogram.....	357
	Repeating program section repeats.....	358
	Repeating a subprogram.....	359
<b>9.6</b>	<b>Programming examples.....</b>	<b>360</b>
	Example: Milling a contour in several infeeds.....	360
	Example: Groups of holes.....	361
	Example: Group of holes with several tools.....	362

<b>10 Programming Q Parameters.....</b>	<b>365</b>
<b>10.1 Principle and overview of functions.....</b>	<b>366</b>
Programming notes.....	368
Calling Q parameter functions.....	369
<b>10.2 Part families—Q parameters in place of numerical values.....</b>	<b>370</b>
Application.....	370
<b>10.3 Describing contours with mathematical functions.....</b>	<b>371</b>
Application.....	371
Overview.....	371
Programming fundamental operations.....	372
<b>10.4 Angle functions.....</b>	<b>374</b>
Definitions.....	374
Programming trigonometric functions.....	374
<b>10.5 Calculation of circles.....</b>	<b>375</b>
Application.....	375
<b>10.6 If-then decisions with Q parameters.....</b>	<b>376</b>
Application.....	376
Unconditional jumps.....	376
Abbreviations used:.....	376
Programming if-then decisions.....	377
<b>10.7 Checking and changing Q parameters.....</b>	<b>378</b>
Procedure.....	378
<b>10.8 Additional functions.....</b>	<b>380</b>
Overview.....	380
FN 14: ERROR: Displaying error messages.....	381
FN16: F-PRINT – Formatted output of texts and Q parameter values.....	385
FN 18: SYSREAD – Reading system data.....	392
FN 19: PLC – Transfer values to the PLC.....	421
FN 20: WAIT FOR – NC and PLC synchronization.....	422
FN 29: PLC – Transfer values to the PLC.....	423
FN 37: EXPORT.....	424
FN 38: SEND – Send information from NC program.....	424
<b>10.9 Accessing tables with SQL commands.....</b>	<b>425</b>
Introduction.....	425
Overview of functions.....	426
Programming SQL commands.....	427
Application example.....	428
SQL BIND.....	429

SQL EXECUTE.....	430
SQL FETCH.....	433
SQL UPDATE.....	434
SQL INSERT.....	435
SQL COMMIT.....	436
SQL ROLLBACK.....	437
SQL SELECT.....	438
<b>10.10 Entering formulas directly.....</b>	<b>439</b>
Entering formulas.....	439
Rules for formulas.....	441
Example of entry.....	442
<b>10.11 String parameters.....</b>	<b>443</b>
String processing functions.....	443
Assign string parameters.....	444
Chain-linking string parameters.....	445
Converting a numerical value to a string parameter.....	446
Copying a substring from a string parameter.....	447
Reading system data.....	448
Converting a string parameter to a numerical value.....	449
Testing a string parameter.....	450
Finding the length of a string parameter.....	451
Comparing alphabetic priority.....	452
Reading out machine parameters.....	453
<b>10.12 Preassigned Q parameters.....</b>	<b>456</b>
Values from the PLC: Q100 to Q107.....	456
Active tool radius: Q108.....	456
Tool axis: Q109.....	457
Spindle status: Q110.....	457
Coolant on/off: Q111.....	457
Overlap factor: Q112.....	457
Unit of measurement for dimensions in the program: Q113.....	457
Tool length: Q114.....	458
Coordinates after probing during program run.....	458
Deviation between actual value and nominal value during automatic tool measurement with, for example, the TT 160.....	458
Tilting the working plane with spatial (workpiece) angles instead of spindle head angles: Coordinates for rotary axes calculated by the control.....	458
Measurement results from touch probe cycles.....	459
<b>10.13 Programming examples.....</b>	<b>461</b>
Example: Ellipse.....	461
Example: Concave cylinder machined with spherical cutter.....	463
Example: Convex sphere machined with end mill.....	465



<b>11 Miscellaneous Functions.....</b>	<b>467</b>
<b>11.1 Entering miscellaneous functions M and STOP.....</b>	<b>468</b>
Fundamentals.....	468
<b>11.2 Miscellaneous functions for program run inspection, spindle and coolant.....</b>	<b>470</b>
Overview.....	470
<b>11.3 Miscellaneous functions for coordinate entries.....</b>	<b>471</b>
Programming machine-referenced coordinates: M91/M92.....	471
Moving to positions in a non-tilted coordinate system with a tilted working plane: M130.....	473
<b>11.4 Miscellaneous functions for path behavior.....</b>	<b>474</b>
Machining small contour steps: M97.....	474
Machining open contour corners: M98.....	475
Feed rate factor for plunging movements: M103.....	476
Feed rate in millimeters per spindle revolution: M136.....	477
Feed rate for circular arcs: M109/M110/M111.....	478
Calculating the radius-compensated path in advance (LOOK AHEAD): M120 (Miscellaneous Functions software option).....	479
Superimposing handwheel positioning during program run: M118 (software option Miscellaneous functions).....	481
Retraction from the contour in the tool-axis direction: M140.....	483
Suppressing touch probe monitoring: M141.....	485
Deleting basic rotation: M143.....	486
Automatically retracting the tool from the contour at an NC stop: M148.....	487
Rounding corners: M197.....	488

<b>12 Special Functions.....</b>	<b>489</b>
<b>12.1 Overview of special functions.....</b>	<b>490</b>
Main menu for SPEC FCT special functions.....	490
Program defaults menu.....	491
Functions for contour and point machining menu.....	491
Menu for defining different conversational functions.....	492
<b>12.2 Tool carrier management.....</b>	<b>493</b>
Fundamentals.....	493
Save tool carrier templates.....	493
Assigning input parameters to tool carriers.....	494
Allocating parameterized tool carriers.....	497
<b>12.3 Active Chatter Control ACC (option 145).....</b>	<b>498</b>
Application.....	498
Activating/deactivating ACC.....	499
<b>12.4 Working with the parallel axes U, V and W.....</b>	<b>500</b>
Overview.....	500
FUNCTION PARAXCOMP DISPLAY.....	501
FUNCTION PARAXCOMP MOVE.....	502
Deactivating FUNCTION PARAXCOMP.....	503
FUNCTION PARAXMODE.....	504
Deactivating FUNCTION PARAXMODE.....	506
Example: Drilling with the W axis.....	507
<b>12.5 File functions.....</b>	<b>508</b>
Application.....	508
Defining file functions.....	508
<b>12.6 Defining coordinate transformations.....</b>	<b>509</b>
Overview.....	509
TRANS DATUM AXIS.....	509
TRANS DATUM TABLE.....	510
TRANS DATUM RESET.....	511
<b>12.7 Defining a counter.....</b>	<b>512</b>
Application.....	512
Define FUNCTION COUNT.....	513
<b>12.8 Creating text files.....</b>	<b>514</b>
Application.....	514
Opening and exiting a text file.....	514
Editing texts.....	515
Deleting and re-inserting characters, words and lines.....	515

Editing text blocks.....	516
Finding text sections.....	517
<b>12.9 Freely definable tables.....</b>	<b>518</b>
Fundamentals.....	518
Creating a freely definable table.....	518
Editing the table format.....	519
Switching between table and form view.....	520
FN 26: TABOPEN – Open a freely definable table.....	521
FN 27: TABWRITE – Write to a freely definable table.....	522
FN 28: TABREAD – Read from a freely definable table.....	523
Customizing the table format.....	523
<b>12.10 Pulsing spindle speed FUNCTION S-PULSE.....</b>	<b>524</b>
Programming a pulsing spindle speed.....	524
Resetting the pulsing spindle speed.....	525
<b>12.11 Dwell time FUNCTION FEED.....</b>	<b>526</b>
Programming dwell time.....	526
Resetting dwell time.....	527
<b>12.12 Dwell time FUNCTION DWELL.....</b>	<b>528</b>
Programming dwell time.....	528
<b>12.13 Lift off tool at NC stop: FUNCTION LIFTOFF.....</b>	<b>529</b>
Programming tool lift-off with FUNCTION LIFTOFF.....	529
Resetting the lift-off function.....	531

<b>13 Multiple-Axis Machining.....</b>	<b>533</b>
<b>13.1 Functions for multiple axis machining.....</b>	<b>534</b>
<b>13.2 The PLANE function: Tilting the working plane (option 8).....</b>	<b>535</b>
Introduction.....	535
Overview.....	537
Defining the PLANE function.....	538
Position display.....	538
Resetting PLANE function.....	539
Defining the working plane with the spatial angle: PLANE SPATIAL.....	540
Defining the working plane with the projection angle: PLANE PROJECTED.....	542
Defining the working plane with the Euler angle: PLANE EULER.....	544
Defining the working plane with two vectors: PLANE VECTOR.....	546
Defining the working plane via three points: PLANE POINTS.....	549
Defining the working plane via a single incremental spatial angle: PLANE RELATIV.....	551
Tilting the working plane through axis angle: PLANE AXIAL.....	552
Specifying the positioning behavior of the PLANE function.....	554
Tilting the working plane without rotary axes.....	562
<b>13.3 Inclined-tool machining in a tilted plane (option 9).....</b>	<b>563</b>
Function.....	563
Inclined-tool machining via incremental traverse of a rotary axis.....	563
Inclined-tool machining via normal vectors.....	564
<b>13.4 Miscellaneous functions for rotary axes.....</b>	<b>565</b>
Feed rate in mm/min on rotary axes A, B, C: M116 (option 8).....	565
Shortest-path traverse of rotary axes: M126.....	566
Reducing display of a rotary axis to a value less than 360°: M94.....	567
Maintaining the position of the tool tip when positioning with tilted axes (TCPM): M128 (option 9).....	568
Selecting tilting axes: M138.....	571
Compensating the machine kinematics in ACTUAL/NOMINAL positions at end of block: M144 (option 9).....	572
<b>13.5 FUNCTION TCPM (option 9).....</b>	<b>573</b>
Function.....	573
Defining FUNCTION TCPM.....	573
Mode of action of the programmed feed rate.....	574
Interpretation of the programmed rotary axis coordinates.....	575
Type of interpolation between the starting and end position.....	576
Selection of tool reference point and center of rotation.....	577
Resetting FUNCTION TCPM.....	578
<b>13.6 Three-dimensional tool compensation (option 9).....</b>	<b>579</b>
Introduction.....	579
Suppressing error messages with positive tool oversize: M107.....	580

Definition of a normalized vector.....	581
Permissible tool shapes.....	582
Using other tools: Delta values.....	582
3-D compensation without TCPM.....	583
Face Milling: 3D compensation with TCPM.....	584
Peripheral milling: 3-D radius compensation with TCPM and radius compensation (RL/RR).....	586
Interpretation of the programmed path.....	588
<b>13.7 Running CAM programs.....</b>	<b>589</b>
From 3-D model to NC program.....	589
Consider with post processor configuration.....	590
Please note the following for CAM programming.....	592
Possibilities for intervention on the control.....	594
ADP motion control.....	595

<b>14 Pallet Management.....</b>	<b>597</b>
<b>14.1 Pallet management (option number 22).....</b>	<b>598</b>
Application.....	598
Selecting pallet table.....	602
Inserting or deleting columns.....	602
Processing pallet table.....	603
<b>14.2 Pallet preset management.....</b>	<b>605</b>
Fundamentals.....	605
Using pallet presets.....	605
<b>14.3 Tool-oriented machining.....</b>	<b>606</b>
Fundamentals.....	606
Sequence of tool-oriented machining.....	608
Mid-program startup with block scan.....	609

**15 Batch Process Manager..... 611**

**15.1 Batch Process Manager (option 154)..... 612**

Fundamentals..... 612

Application..... 612

Opening the Batch Process Manager..... 615

Creating a job list..... 615

Editing a job list..... 617

Executing the job list..... 618

<b>16 Manual Operation and Setup.....</b>	<b>619</b>
<b>16.1 Switch-on, switch-off.....</b>	<b>620</b>
Switch-on.....	620
Traverse reference points.....	622
Switch-off.....	624
<b>16.2 Moving the machine axes.....</b>	<b>625</b>
Note.....	625
Moving the axis with the axis direction keys.....	625
Incremental jog positioning.....	626
Traverse with electronic handwheels.....	627
<b>16.3 Spindle speed S, feed rate F and miscellaneous function M.....</b>	<b>637</b>
Application.....	637
Entering values.....	637
Adjusting spindle speed and feed rate.....	638
Feed rate limit F MAX.....	638
<b>16.4 Optional safety concept (functional safety FS).....</b>	<b>639</b>
Miscellaneous.....	639
Explanation of terms.....	640
Additional status displays.....	641
Checking the axis positions.....	642
Activating feed-rate limitation.....	643
<b>16.5 Managing presets.....</b>	<b>644</b>
Note.....	644
Saving presets in the table.....	644
Protecting presets from being overwritten.....	649
Activating a preset.....	651
<b>16.6 Presetting without a 3-D touch probe.....</b>	<b>652</b>
Note.....	652
Preparation.....	652
Presetting setting with an end mill.....	652
Using touch probe functions with mechanical probes or measuring dials.....	653
<b>16.7 Using a 3-D touch probe (option 17).....</b>	<b>654</b>
Introduction.....	654
Overview.....	655
Suppress touch probe monitoring.....	657
Functions in touch probe cycles.....	657
Selecting the probing cycle.....	660
Recording measured values from the touch probe cycles.....	660
Writing measured values from the touch probe cycles to a datum table.....	661
Writing measured values from the touch-probe cycles to the preset table.....	662



<b>16.8</b>	<b>Calibrating 3-D touch probes (option 17)</b> .....	<b>663</b>
	Introduction.....	663
	Calibrating the effective length.....	664
	Calibrating the effective radius and compensating center misalignment.....	665
	Displaying calibration values.....	668
<b>16.9</b>	<b>Compensating workpiece misalignment with 3-D touch probe (option 17)</b> .....	<b>669</b>
	Introduction.....	669
	Identifying basic rotation.....	670
	Saving the basic rotation in the preset table.....	670
	Compensation of workpiece misalignment by rotating the table.....	671
	Show basic rotation and offset.....	672
	Rescind basic rotation or offset.....	672
	Measuring 3-D basic rotation.....	673
<b>16.10</b>	<b>Presetting with a 3-D touch probe (option number 17)</b> .....	<b>676</b>
	Overview.....	676
	Presetting on any axis.....	677
	Corner as preset.....	678
	Circle center as preset.....	680
	Setting a center line as preset.....	683
	Measuring workpieces with a 3-D touch probe.....	684
<b>16.11</b>	<b>Tilting the working plane (option 8)</b> .....	<b>687</b>
	Application, function.....	687
	Position display in a tilted system.....	689
	Limitations on working with the tilting function.....	689
	Activating manual tilting:.....	690
	Setting the tool-axis direction as the active machining direction.....	692
	Setting a preset in a tilted coordinate system.....	692

<b>17 Positioning with Manual Data Input.....</b>	<b>693</b>
<b>17.1 Programming and executing simple machining operations.....</b>	<b>694</b>
Positioning with manual data input (MDI).....	695
Protecting programs in \$MDI.....	697

<b>18 Test Run and Program Run.....</b>	<b>699</b>
<b>18.1 Graphics (option 20).....</b>	<b>700</b>
Application.....	700
Speed of the setting test runs.....	701
Overview: Display modes.....	702
3-D view.....	702
Plan view.....	706
Projection in three planes.....	706
Repeating graphic simulation.....	708
Tool display.....	708
Measurement of machining time.....	709
<b>18.2 Showing the workpiece blank in the working space (option 20).....</b>	<b>710</b>
Application.....	710
<b>18.3 Functions for program display.....</b>	<b>712</b>
Overview.....	712
<b>18.4 Test run.....</b>	<b>713</b>
Application.....	713
Test run execution.....	715
Test Run up to a certain block.....	716
<b>18.5 Program run.....</b>	<b>717</b>
Application.....	717
Running a part program.....	718
Interrupting, stopping or aborting machining.....	719
Moving the machine axes during an interruption.....	722
Resuming program run after an interruption.....	723
Retraction after a power interruption.....	724
Entering the program at any point: Mid-program startup.....	727
Returning to the contour.....	733
<b>18.6 Automatic program start.....</b>	<b>734</b>
Application.....	734
<b>18.7 Skipping blocks.....</b>	<b>735</b>
Application.....	735
Delete / symbol.....	735
Delete / symbol.....	735
<b>18.8 Optional program-run interruption.....</b>	<b>736</b>
Application.....	736

<b>19 MOD Functions.....</b>	<b>737</b>
<b>19.1 MOD function.....</b>	<b>738</b>
Selecting MOD functions.....	738
Changing the settings.....	738
Exiting MOD functions.....	738
Overview of MOD functions.....	739
<b>19.2 Graphic settings.....</b>	<b>740</b>
<b>19.3 Counter settings.....</b>	<b>741</b>
<b>19.4 Machine settings.....</b>	<b>742</b>
External access.....	742
Entering traverse limits.....	744
Tool usage file.....	745
Select kinematics.....	745
<b>19.5 System settings.....</b>	<b>746</b>
Set the system time.....	746
<b>19.6 Select the position display.....</b>	<b>747</b>
Application.....	747
<b>19.7 Setting the unit of measure.....</b>	<b>749</b>
Application.....	749
<b>19.8 Displaying operating times.....</b>	<b>749</b>
Application.....	749
<b>19.9 Software numbers.....</b>	<b>750</b>
Application.....	750
<b>19.10 Enter the code number.....</b>	<b>750</b>
Application.....	750
<b>19.11 Setting up data interfaces.....</b>	<b>751</b>
Serial interfaces on the TNC 620.....	751
Application.....	751
Setting the RS-232 interface.....	751
Set BAUD RATE (baud rate no. 106701).....	751
Set protocol (protocol no. 106702).....	752
Set data bits (dataBits no. 106703).....	752
Check parity (parity no. 106704).....	752
Set stop bits (stopBits no. 106705).....	752
Set handshake (flowControl no. 106706).....	753
File system for file operation (fileSystem no. 106707).....	753
Block check character (bccAvoidCtrlChar no. 106708).....	753

Condition of RTS line (rtsLow no. 106709).....	753
Define behavior after receipt of ETX (noEotAfterEtx no. 106710).....	754
Settings for the transmission of data using PC software TNCserver.....	754
Setting the operating mode of the external device (fileSystem).....	755
Software for data transfer.....	755
<b>19.12 Ethernet interface.....</b>	<b>757</b>
Introduction.....	757
Connection possibility.....	757
Configuring the control.....	757
<b>19.13 Firewall.....</b>	<b>763</b>
Application.....	763
<b>19.14 Set up touch probes.....</b>	<b>766</b>
Introduction.....	766
Setting up a touch probe with radio transmission.....	766
Setting up a touch probe in the MOD dialog.....	767
Touch probe with radio transmission configuration.....	768
<b>19.15 Configuring the HR 550FS wireless handwheel.....</b>	<b>770</b>
Application.....	770
Assigning the handwheel to a specific handwheel holder.....	770
Setting the transmission channel.....	771
Selecting the transmitter power.....	771
Statistical data.....	772
<b>19.16 Load machine configuration.....</b>	<b>773</b>
Application.....	773

<b>20 Tables and Overviews.....</b>	<b>775</b>
<b>20.1 Machine-specific user parameters.....</b>	<b>776</b>
Application.....	776
<b>20.2 Connector pin layout and connection cables for data interfaces.....</b>	<b>790</b>
RS-232-C/V.24 interface for HEIDENHAIN devices.....	790
Non-HEIDENHAIN devices.....	792
Ethernet interface RJ45 socket.....	792
<b>20.3 Technical Information.....</b>	<b>793</b>
User functions.....	795
Software options.....	798
Accessories.....	801
<b>20.4 Overview tables.....</b>	<b>802</b>
Fixed cycles.....	802
Miscellaneous functions.....	804
<b>20.5 Functions of the TNC 620 and the iTNC 530 compared.....</b>	<b>806</b>
Comparison: Specifications.....	806
Comparison: Data interfaces.....	806
Comparison: PC software.....	807
Comparison: User functions.....	807
Comparison: Miscellaneous functions.....	815
Comparator: Cycles.....	817
Comparison: Touch probe cycles in the Manual operation and Electronic handwheel modes of operation.....	819
Comparison: Probing system cycles for automatic workpiece control.....	820
Comparison: Differences in programming.....	822
Comparison: Differences in Test Run, functionality.....	825
Comparison: Differences in Test Run, operation.....	826
Comparison: Differences in Manual Operation, functionality.....	827
Comparison: Differences in Manual Operation, operation.....	828
Comparison: Differences in Program Run, operation.....	828
Comparison: Differences in Program Run, traverse movements.....	829
Comparison: Differences in MDI operation.....	834
Comparison: Differences in programming station.....	834

# 1

**First Steps with  
the TNC 620**

## 1.1 Overview

This chapter is intended to help users quickly learn to handle the most important procedures on the control. For more information on a respective topic, see the section referred to in the text.

The following topics are included in this chapter:

- Machine switch-on
- Programming the first part
- Graphically testing the first part
- Setting up tools
- Workpiece setup
- Running the first program

## 1.2 Machine switch-on

### Acknowledging the power interruption and moving to the reference points

#### **⚠ DANGER**

##### **Caution: Danger for the operator!**

Machines and machine components always present mechanical hazards. Electric, magnetic or electromagnetic fields are particularly hazardous for persons with cardiac pacemakers or implants. The hazard starts when the machine is powered up!

- ▶ Read and follow the machine manual
- ▶ Read and follow the safety precautions and safety symbols
- ▶ Use the safety devices



Refer to your machine manual.

Switching on the machine and traversing the reference points can vary depending on the machine tool.

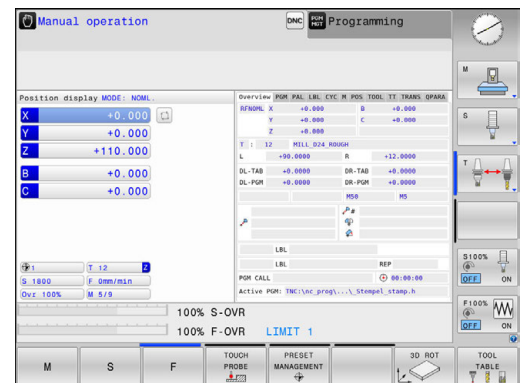



- ▶ Switch on the power supply for control and machine
- > The control starts the operating system. This process may take several minutes.
- > The control will then display the "Power interrupted" message in the screen header.



- ▶ Press the **CE** key
- > The control compiles the PLC program.



- ▶ Switch on the machine control voltage
- > The control checks operation of the emergency stop circuit and goes into Reference Run mode.



- ▶ Cross the reference point manually in the prescribed sequence: For each axis press the **START** key. If you have absolute linear and angle encoders on your machine there is no need for a reference run
- > The control is now ready for operation in the **Manual operation** mode.

#### Further information on this topic

- Approaching reference points  
**Further information:** "Switch-on", page 620
- Operating modes  
**Further information:** "Programming", page 92

## 1.3 Programming the first part

### Selecting the correct operating mode

You can write programs only in **Programming** mode:







- ▶ Press the operating mode key
- > The control switches to the **Programming** mode of operation.

#### Further information on this topic

- Operating modes  
**Further information:** "Programming", page 92

### The most important control keys

Key	Functions for conversational guidance
	Confirm entry and activate the next dialog prompt
	Ignore the dialog question
	End the dialog immediately
	Abort dialog, discard entries
	Soft keys on the screen with which you select functions appropriate to the active operating state

#### Further information on this topic

- Writing and editing programs  
**Further information:** "Editing an NC program", page 162
- Overview of keys  
**Further information:** "Controls and displays", page 2

## Opening a new program/file management

PGM  
MGT

- ▶ Press the **PGM MGT** key
- ▶ The control opens the file manager.

The file management of the control is arranged much like the file management on a PC with Windows Explorer. The file management enables you to manage data in the control's internal memory.

- ▶ Use the arrow keys to select the folder in which you want to open the new file
- ▶ Enter any desired file name with the extension **.H**

ENT

- ▶ Press the **ENT** key
- ▶ The control asks you for the unit of measure for the new program.

MM

- ▶ Select the unit of measure: Press the **MM** or **INCH** soft key

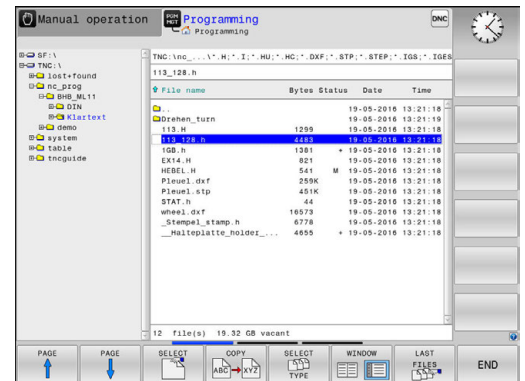

The control automatically generates the first and last blocks of the program. Afterwards you can no longer change these blocks.

### Further information on this topic

- File management  
**Further information:** "Working with the file manager", page 171
- Creating a new program  
**Further information:** "Creating and writing programs", page 154

## Defining a workpiece blank

After you have created a new program you can define a workpiece blank. For example, define a cuboid by entering the MIN and MAX points, each with reference to the selected preset.

After you have selected the desired blank form via soft key, the control automatically initiates the workpiece blank definition and asks for the required data:

- ▶ **Working plane in graphic: XY?:** Enter the active spindle axis. Z is saved as default setting. Accept with the **ENT** key
  - ▶ **Workpiece blank def.: Minimum X:** Enter the smallest X coordinate of the workpiece blank with respect to the preset, e.g. 0, confirm with the **ENT** key
  - ▶ **Workpiece blank def.: Minimum Y:** Enter the smallest Y coordinate of the workpiece blank with respect to the preset, e.g. 0, confirm with the **ENT** key
  - ▶ **Workpiece blank def.: Minimum Z:** Enter the smallest Z coordinate of the workpiece blank with respect to the preset, e.g. -40, confirm with the **ENT** key
  - ▶ **Workpiece blank def.: Maximum X:** Enter the largest X coordinate of the workpiece blank with respect to the preset, e.g. 100, confirm with the **ENT** key
  - ▶ **Workpiece blank def.: Maximum Y:** Enter the largest Y coordinate of the workpiece blank with respect to the preset, e.g. 100, confirm with the **ENT** key
  - ▶ **Workpiece blank def.: Maximum Z:** Enter the largest Z coordinate of the workpiece blank with respect to the preset, e.g. 0, confirm with the **ENT** key
- > The control ends the dialog.

### Example

```
0 BEGIN PGM NEW MM
1 BLK FORM 0.1 Z X+0 Y+0 Z-40
2 BLK FORM 0.2 X+100 Y+100 Z+0
3 END PGM NEW MM
```

### Further information on this topic

- Define workpiece blank  
**Further information:** "Creating a new NC program", page 158

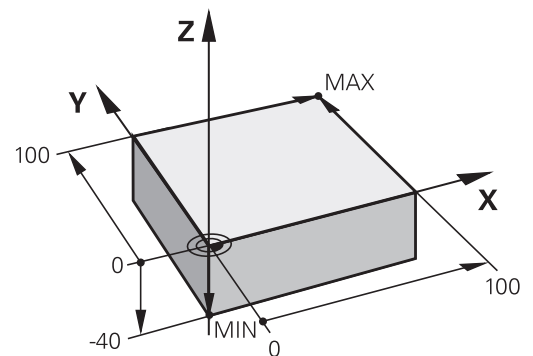
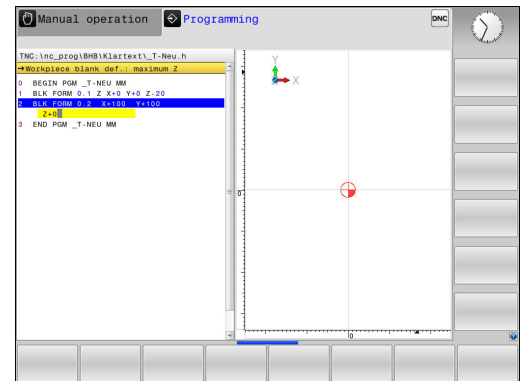

## Program layout

NC programs should be arranged consistently in a similar manner. This makes it easier to find your place, accelerates programming and reduces errors.

### Recommended program layout for simple, conventional contour machining

#### Example

0	BEGIN PGM	BSPCONT	MM
1	BLK FORM 0.1	Z X...	Y... Z...
2	BLK FORM 0.2	X... Y...	Z...
3	TOOL CALL	5 Z	S5000
4	L	Z+250 R0	FMAX
5	L	X... Y...	R0 FMAX
6	L	Z+10 R0	F3000 M13
7	APPR ...	X... Y...RL	F500
...			
16	DEP ...	X... Y...	F3000 M9
17	L	Z+250 R0	FMAX M2
18	END PGM	BSPCONT	MM

- 1 Call tool, define tool axis
- 2 Retract the tool
- 3 Pre-position the tool in the working plane near the contour starting point
- 4 In the tool axis, position the tool above the workpiece, or preposition immediately to workpiece depth. If required, switch on the spindle/coolant
- 5 Contour approach
- 6 Contour machining
- 7 Contour departure
- 8 Retract the tool, end program

#### Further information on this topic

- Contour programming
  - Further information:** "Programming tool movements for workpiece machining", page 274

## Recommended program layout for simple cycle programs

### Example

```
0 BEGIN PGM BSBCYC MM
1 BLK FORM 0.1 Z X... Y... Z...
2 BLK FORM 0.2 X... Y... Z...
3 TOOL CALL 5 Z S5000
4 L Z+250 R0 FMAX
5 PATTERN DEF POS1( X... Y... Z... ) ...
6 CYCL DEF...
7 CYCL CALL PAT FMAX M13
8 L Z+250 R0 FMAX M2
9 END PGM BSBCYC MM
```

- 1 Call tool, define tool axis
- 2 Retract the tool
- 3 Define the machining positions
- 4 Define the fixed cycle
- 5 Call the cycle, switch on the spindle/coolant
- 6 Retract the tool, end program

### Further information on this topic

- Cycle programming  
**Further information:** Cycle Programming User's Manual

## Programming a simple contour

The contour shown to the right is to be milled once to a depth of 5 mm. You have already defined the workpiece blank. After you have initiated a dialog through a function key, enter all the data requested by the control in the screen header.



- ▶ Call the tool: Enter the tool data. Confirm the entry in each case with the **ENT** key, and do not forget the **Z** tool axis



- ▶ Retracting tool: Press the orange axis key **Z** and enter the value for the position to be approached, e.g. 250. Press the **ENT** key
- ▶ Confirm **Tool radius comp: RL/RR/no comp?** with the **ENT** key: Do not activate radius compensation
- ▶ Confirm **Feed F=?** with the **ENT** key: Rapid traverse (**FMAX**)
- ▶ Enter **Miscellaneous function M?** and confirm with the **ENT** key



- > The control stores the entered positioning block.
- ▶ Preposition the tool in the working plane: Press the orange **X** axis key and enter the value for the position to be approached, e.g. -20
- ▶ Press the orange axis key **Y** and enter the value for the position to be approached, e.g. -20. Press the **ENT** key
- ▶ Confirm **Tool radius comp: RL/RR/no comp?** with the **ENT** key: Do not activate radius compensation
- ▶ Confirm **Feed F=?** with the **ENT** key: Rapid traverse (**FMAX**)
- ▶ Confirm **Miscellaneous function M?** with the **ENT** key



- > The control stores the entered positioning block.
- ▶ Move tool to working depth: Press the orange axis key **Z** and enter the value for the position to be approached, e.g. -5. Press the **ENT** key
- ▶ Confirm **Tool radius comp: RL/RR/no comp?** with the **ENT** key: Do not activate radius compensation
- ▶ **Feed rate F=?** Enter the positioning feed rate, e.g. 3000 mm/min, confirm with the **ENT** key
- ▶ **Miscellaneous function M?** Switch on the spindle and coolant, e.g. **M13**, and confirm with the **ENT** key



- > The control stores the entered positioning block.
- ▶ Move to the contour: Press the **APPR DEP** key
- > The control displays a soft-key row with approach and departure functions.

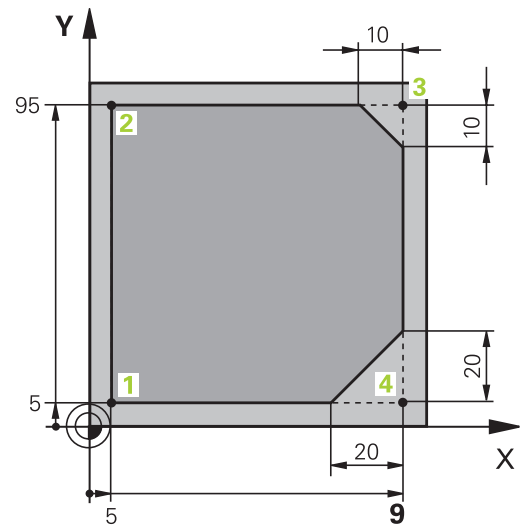

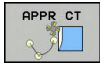

- ▶ Press the approach function soft key **APPR CT**: Enter the coordinates of the contour starting point **1** in X and Y, e.g. 5/5, confirm with the **ENT** key
- ▶ **Center angle?** Enter the approach angle, e.g. 90°, confirm with the **ENT** key
- ▶ **Circle radius?** Enter the circular radius, e.g. 8 mm, confirm with the **ENT** key
- ▶ Confirm **Tool radius comp: RL/RR/no comp?** with the **RL** soft key: Activate the radius compensation to the left of the programmed contour
- ▶ **Feed rate F=?** Enter the machining feed rate, e.g. 700 mm/min, save your entry with the **END** key



- ▶ Machine the contour and move to contour point **2**: You only need to enter the information that changes. In other words, enter the Y coordinate 95 and save your entry with the **END** key



- ▶ Move to contour point **3**: Enter the X coordinate 95 and save your entry with the **END** key



- ▶ Define the chamfer at contour point **3**: Enter the chamfer width 10 mm and save with the **END** key



- ▶ Move to contour point **4**: Enter the Y coordinate 5 and save your entry with the **END** key



- ▶ Define the chamfer at contour point **4**: Enter the chamfer width 20 mm and save with the **END** key



- ▶ Move to contour point **1**: Enter the X coordinate 5 and save your entry with the **END** key



- ▶ Depart contour: Press the APPR DEP key



- ▶ Departure function: Press the **DEP CT** soft key
- ▶ **Center angle?** Enter the departure angle, e.g. 90°, confirm with the **ENT** key
- ▶ **Circle radius?** Enter the departure radius, e.g. 8 mm, confirm with the **ENT** key
- ▶ **Feed rate F=?** Enter the positioning feed rate, e.g. 3000 mm/min, confirm with the **ENT** key
- ▶ **Miscellaneous function M?** Switch off the coolant, e.g. **M9**, and confirm with the **END** key
- ▶ The control stores the entered positioning block.















- ▶ Retracting tool: Press the orange axis key **Z** and enter the value for the position to be approached, e.g. 250. Press the **ENT** key
- ▶ Confirm **Tool radius comp: RL/RR/no comp?** with the **ENT** key: Do not activate radius compensation
- ▶ Confirm **Feed F=?** with the **ENT** key: Rapid traverse (**FMAX**)
- ▶ **Miscellaneous function M?** Enter **M2** to end the program, then confirm with the **END** key
- ▶ The control stores the entered positioning block.

#### Further information on this topic

- **Complete example with NC blocks**  
**Further information:** "Example: Linear movements and chamfers with Cartesian coordinates", page 297
- Creating a new program  
**Further information:** "Creating and writing programs", page 154
- Approaching/departing contours  
**Further information:** "Approaching and departing a contour", page 278
- Programming contours  
**Further information:** "Overview of path functions", page 288
- Programmable feed rates  
**Further information:** "Possible feed rate input", page 160
- Tool radius compensation  
**Further information:** "Tool radius compensation ", page 257
- Miscellaneous functions M  
**Further information:** "Miscellaneous functions for program run inspection, spindle and coolant ", page 470

## Creating a cycle program

The holes (depth of 20 mm) shown in the figure at right are to be drilled with a standard drilling cycle. You have already defined the workpiece blank.

- 
  - ▶ Call the tool: Enter the tool data. Confirm the entry in each case with the **ENT** key, do not forget the tool axis
- 
  - ▶ Press the **L** key to open an NC block for a linear movement
  - ▶ Retract tool: Press the orange axis key **Z** and enter the value for the position to be approached, e.g. 250. Press the **ENT** key
  - ▶ Confirm **Radius comp.: RL/RR/no comp.?** by pressing the **ENT** key: Do not activate radius compensation
  - ▶ Confirm **Feed rate F=?** with the **ENT** key: Move at rapid traverse (**FMAX**)
  - ▶ **Miscellaneous function M?** Confirm with the **END** key
  - ▶ The control stores the entered positioning block.
  - ▶ Call the menu for special functions: Press the **SPEC FCT** key
  - ▶ Display the functions for point machining
- 
  - ▶ Select the pattern definition
- 
  - ▶ Select point entry: Enter the coordinates of the 4 points and confirm each with the **ENT** key. After entering the fourth point, save the block with the **END** key
- 
  - ▶ Call the cycle menu: Press the **CYCL DEF** key
- 
  - ▶ Display the drilling cycles
- 
  - ▶ Select standard drilling cycle 200
  - ▶ The control starts the dialog for cycle definition.
  - ▶ Enter all parameters requested by the control step by step and conclude each entry with the **ENT** key
  - ▶ In the screen to the right, the control also displays a graphic showing the respective cycle parameter
- 
  - ▶ Display the menu for defining the cycle call: Press the **CYCL CALL** key
- 
  - ▶
- 

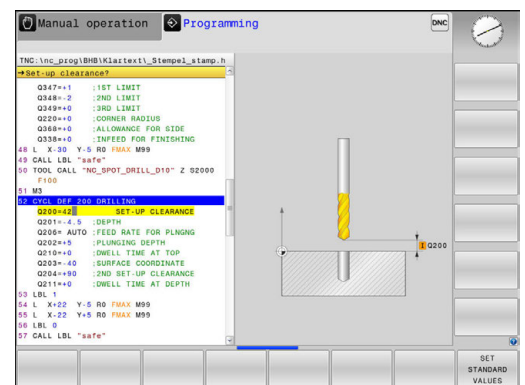
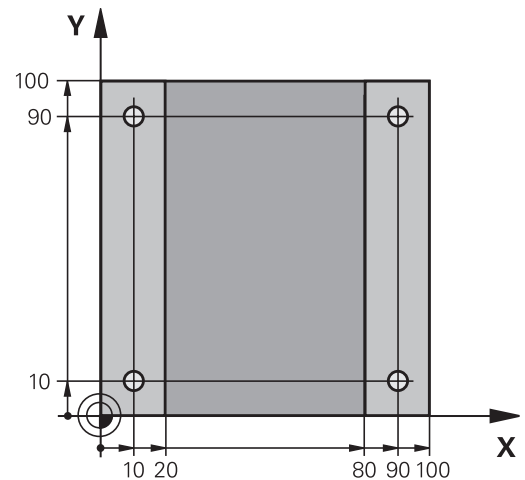

A rectangular button with a grey background and black text that reads "CYCLE CALL PAT".

- ▶ Run the drilling cycle on the defined pattern:
- ▶ Confirm **Feed rate F=?** with the **ENT** key: Move at rapid traverse (**FMAX**)
- ▶ **Miscellaneous function M?** Switch on the spindle and coolant, e.g. **M13**, and confirm with the **ENT** key
- ▶ The control stores the entered positioning block.

A square button with a grey background, a black border, and a stylized 'L' symbol.

- ▶ Enter Retract tool: Press the orange axis key **Z** and enter the value for the position to be approached, e.g. 250. Press the **ENT** key
- ▶ Confirm **Radius comp.: RL/RR/no comp.?** by pressing the **ENT** key: Do not activate radius compensation
- ▶ Confirm **Feed rate F=?** with the **ENT** key: Move at rapid traverse (**FMAX**)
- ▶ **Miscellaneous function M?** Enter **M2** to end the program, then confirm with the **ENT** key
- ▶ The control stores the entered positioning block.

**Example**

0 BEGIN PGM C200 MM	
1 BLK FORM 0.1 Z X+0 Y+0 Z-40	Workpiece blank definition
2 BLK FORM 0.2 X+100 Y+100 Z+0	
3 TOOL CALL 5 Z S4500	Tool call
4 L Z+250 R0 FMAX	Retract the tool
5 PATTERN DEF POS1 (X+10 Y+10 Z+0) POS2 (X+10 Y+90 Z+0) POS3 (X+90 Y+90 Z+0) POS4 (X+90 Y+10 Z+0)	Define the machining positions
6 CYCL DEF 200 DRILLING	Define the cycle
Q200=2 ;SET-UP CLEARANCE	
Q201=-20 ;DEPTH	
Q206=250 ;FEED RATE FOR PLNGNG	
Q202=5 ;PLUNGING DEPTH	
Q210=0 ;DWELL TIME AT TOP	
Q203=-10 ;SURFACE COORDINATE	
Q204=20 ;2ND SET-UP CLEARANCE	
Q211=0.2 ;DWELL TIME AT DEPTH	
Q395=0 ;DEPTH REFERENCE	
7 CYCL CALL PAT FMAX M13	Spindle and coolant on, call the cycle
8 L Z+250 R0 FMAX M2	Retract the tool, end program
9 END PGM C200 MM	

**Further information on this topic**

- Creating a new program  
**Further information:** "Creating and writing programs", page 154
- Cycle programming  
**Further information:** Cycle Programming User's Manual

## 1.4 Graphically testing the first part (option 20)

### Selecting the correct operating mode

You can test programs in the **Test Run** operating mode:

-  ▶ Press the operating mode key
- ▶ The control switches to the **Test Run** mode of operation.





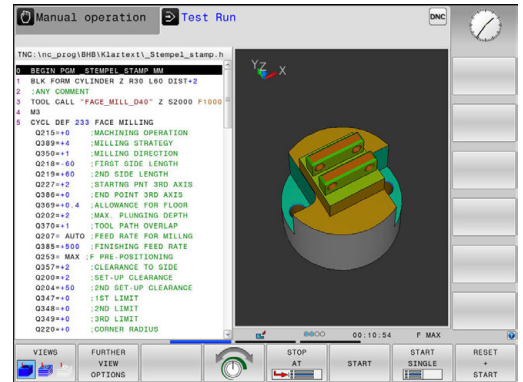



#### Further information on this topic

- Operating modes of the control  
**Further information:** "Modes of operation", page 91
- Testing programs  
**Further information:** "Test run", page 713



### Selecting the tool table for the test run

If you have not yet activated a tool table in **Test Run** mode, then you must carry out this step.

-  ▶ Press the **PGM MGT** key
- ▶ The control opens the file manager.
-  ▶ Press the **SELECT TYPE** soft key
- ▶ The control shows a soft-key menu for selection of the file type to be displayed.
-  ▶ Press the **DEFAULT** soft key
- ▶ The control shows all saved files in the right-hand window.
-  ▶ Move the cursor to the left onto the directories
-  ▶ Move the cursor to the **TNC:\table** directory
-  ▶ Move the cursor to the right onto the files
-  ▶ Move the cursor onto the file **TOOL.T** (active tool table), confirm with the **ENT** key: **TOOL.T** contains the status **S** and is therefore active for **Test Run**
-  ▶ Press the **END** key: Exit the file manager

#### Further information on this topic

- Tool management  
**Further information:** "Entering tool data into the table", page 234
- Testing programs  
**Further information:** "Test run", page 713

## Choosing the program you want to test



- ▶ Press the **PGM MGT** key
- > The control opens the file manager.

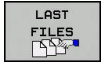

- ▶ Press the **LAST FILES** soft key
- > The control opens a pop-up window with the most recently selected files.
- ▶ Use the arrow keys to select the program that you want to test. Load with the **ENT** key

### Further information on this topic

- Program number  
**Further information:** "Working with the file manager", page 171

## Selecting the screen layout and the view



- ▶ Press the key for selecting the screen layout
- > The control displays all available alternatives in the soft-key row.



- ▶ Press the **PROGRAM + GRAPHICS** soft key
- > In the left half of the screen the control shows the program; in the right half it shows the workpiece blank.

The control features the following views:

Soft keys	Function
	Volume view
	Volume view and tool paths
	Tool paths

### Further information on this topic

- Graphic functions  
**Further information:** "Graphics (option 20)", page 700
- Performing a test run  
**Further information:** "Test run", page 713

## Starting the test run



- ▶ Press the **RESET + START** soft key
- > The control resets the previously active tool data
- > The control simulates the active program up to a programmed break or to the program end
- ▶ While the simulation is running, you can use the soft keys to change views



- ▶ Press the **STOP** soft key
- > The control interrupts the test run



- ▶ Press the **START** soft key
- > The control resumes the test run after a break

## Further information on this topic

- Performing a test run  
**Further information:** "Test run", page 713
- Graphic functions  
**Further information:** "Graphics (option 20)", page 700
- Adjusting the simulation speed  
**Further information:** "Speed of the setting test runs", page 701

## 1.5 Setting up tools

### Selecting the correct operating mode

Tools are set up in the **Manual operation** mode:



- ▶ Press the operating mode key
- > The control switches to the **Manual operation** mode.

### Further information on this topic

- Operating modes of the control  
**Further information:** "Modes of operation", page 91

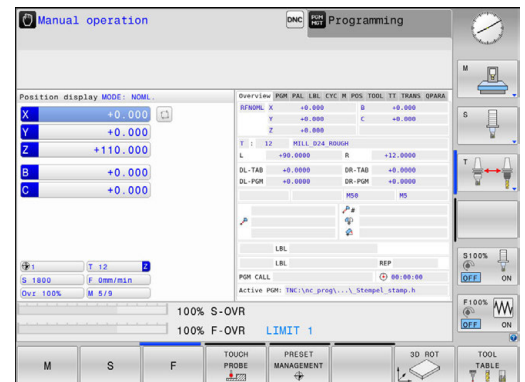

### Preparing and measuring tools

- ▶ Clamp the required tools in their tool holders
- ▶ When measuring with an external tool presetter: Measure the tools, note down the length and radius, or transfer them directly to the machine through a transfer program
- ▶ When measuring on the machine: store the tools in the tool changer  
**Further information:** "The pocket table TOOL\_PTCH", page 82



## The tool table TOOL.T



Refer to your machine manual.  
The procedure for calling the tool management may differ from that described below.

In the TOOL.T tool table (permanently stored under **TNC:\table\**), you can save tool data such as length and radius, as well as further tool-specific information that the control needs in order to execute a wide variety of functions.

To enter tool data in the tool table TOOL.T, proceed as follows:



- ▶ Display the tool table
- > The control shows the tool table.



- ▶ Edit the tool table: Set the **EDIT** soft key to **ON**
- ▶ With the upward or downward arrow keys you can select the tool number that you want to edit
- ▶ With the rightward or leftward arrow keys you can select the tool data that you want to edit
- ▶ To exit the tool table, press the **END** key

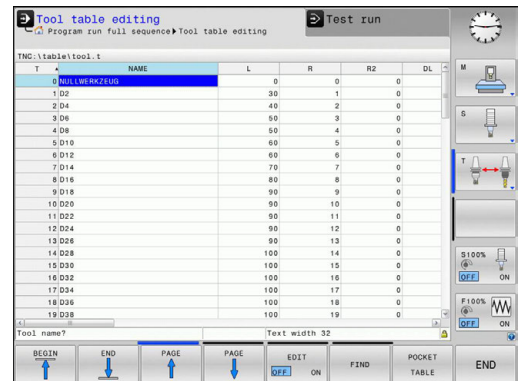

### Further information on this topic

- Operating modes of the control  
**Further information:** "Modes of operation", page 91
- Working with the tool table  
**Further information:** "Entering tool data into the table", page 234
- Using the tool management (option 93)  
**Further information:** "Calling tool management", page 261

## The pocket table TOOL\_PTCH



Refer to your machine manual.

The function of the pocket table depends on the machine.

In the pocket table TOOL\_PTCH (permanently saved under **TNC:\table\**) you specify which tools your tool magazine contains. To enter data in the pocket table TOOL\_PTCH, proceed as follows:



- ▶ Display the tool table
- ▶ The control shows the tool table.

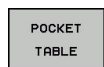

- ▶ Display the pocket table
- ▶ The control shows the pocket table.
- ▶ Edit the pocket table: Set the **EDIT** soft key to **ON**
- ▶ With the upward or downward arrow keys you can select the pocket number that you want to edit
- ▶ With the rightward or leftward arrow keys you can select the data that you want to edit
- ▶ To leave the pocket table, press the **END** key

P	TNAME	RSV	ST	F	L	DOC
0 0	D10					
1.1	1 D2					Tool 1
1.2	2 D4					Tool 2
1.3	3 D6					Tool 3
1.4	4 D8					Tool 4
1.5	5 D10		R			
1.6	6 D12					
1.7	7 D14					
1.8	8 D16					
1.9	9 D18					
1.10	10 D20					
1.11	11 D22					
1.12	12 D24					
1.13	13 D26					
1.14	14 D28					
1.15	15 D30					
1.16	16 D32					
1.17	17 D34					
1.18	18 D36					
1.19	19 D38					

### Further information on this topic

- Operating modes of the control  
**Further information:** "Modes of operation", page 91
- Working with the pocket table  
**Further information:** "Pocket table for tool changer", page 246

## 1.6 Workpiece setup

### Selecting the correct operating mode

Workpieces are set up in the **Manual operation** or **Electronic handwheel** mode



- ▶ Press the operating mode key
- > The control switches to the **Manual operation** mode.

#### Further information on this topic

- The operating mode **Manual operation**  
**Further information:** "Moving the machine axes", page 625

### Clamping the workpiece

Mount the workpiece with a fixture on the machine table. If you have a 3-D touch probe on your machine, then you do not need to clamp the workpiece parallel to the axes.

If you do not have a 3-D touch probe available, you have to align the workpiece so that it is fixed with its edges parallel to the machine axes.

#### Further information on this topic

- Presetting with a 3-D touch probe  
**Further information:** "Presetting with a 3-D touch probe (option number 17)", page 676
- Presetting without 3-D touch probe  
**Further information:** "Presetting without a 3-D touch probe", page 652

## Presetting with a 3-D touch probe (option number 17)

- ▶ Insert a 3-D touch probe: In the **Positioning w/ Manual Data Input** mode, run a **TOOL CALL** block containing the tool axis and then return to the **Manual operation** mode



- ▶ Press the **TOUCH PROBE** soft key
- > The control displays the available functions in the soft-key row.

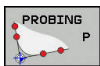

- ▶ Set the preset at a workpiece corner, for example
- ▶ Use the axis direction keys to position the touch probe near the first touch point on the first workpiece edge
- ▶ Select the probing direction via soft key
- ▶ Press the **NC start** key
- > The touch probe moves in the defined direction until it contacts the workpiece and then automatically returns to its starting point.
- ▶ Use the axis direction keys to pre-position the touch probe near the second touch point on the first workpiece edge
- ▶ Press the **NC start** key
- > The touch probe moves in the defined direction until it contacts the workpiece and then automatically returns to its starting point.
- ▶ Use the axis direction keys to pre-position the touch probe near the first touch point on the second workpiece edge
- ▶ Select the probing direction via soft key
- ▶ Press the **NC start** key
- > The touch probe moves in the defined direction until it contacts the workpiece and then automatically returns to its starting point.
- ▶ Use the axis direction keys to pre-position the touch probe near the second touch point on the second workpiece edge
- ▶ Press the **NC start** key
- > The touch probe moves in the defined direction until it contacts the workpiece and then automatically returns to its starting point.
- > The control then displays the coordinates of the measured corner point.



- ▶ To set to 0: Press the **SET PRESET** soft key
- ▶ Press the **END** soft key to close the menu



### Further information on this topic

- Presetting  
**Further information:** "Presetting with a 3-D touch probe (option number 17)", page 676

## 1.7 Running the first program

### Selecting the correct operating mode

You can run programs either in the **Program run, single block** or the **Program run, full sequence** mode:

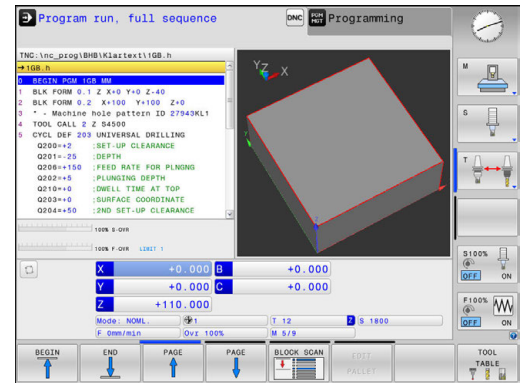

- 
  - ▶ Press the operating mode key
  - ▶ The control switches to the operating mode **Program run, single block**, and executes the NC program block by block.
  - ▶ You have to confirm each block with the **NC start key**
- 
  - ▶ Press the operating mode key
  - ▶ The control switches to the operating mode **Program run, full sequence**, and executes the program after NC start up to a program interruption or to the end of the program



### Further information on this topic

- Operating modes of the control  
**Further information:** "Modes of operation", page 91
- Executing a program  
**Further information:** "Program run", page 717

### Choosing the program you want to run

- 
  - ▶ Press the **PGM MGT** key
  - ▶ The control opens the file manager.
- 
  - ▶ Press the **LAST FILES** soft key
  - ▶ The control opens a pop-up window with the most recently selected files.
  - ▶ Use the arrow keys if required to select the program you want to run. Load with the **ENT** key

### Further information on this topic

- File management  
**Further information:** "Working with the file manager", page 171

### Starting the program

- 
  - ▶ Press the **NC start key**
  - ▶ The control runs the active program.

### Further information on this topic

- Executing a program  
**Further information:** "Program run", page 717



# 2

**Introduction**

## 2.1 The TNC 620

HEIDENHAIN TNC controls are workshop-oriented contouring controls that enable you to program conventional milling and drilling operations right at the machine in easy-to-use Klartext conversational language. They are designed for milling, drilling and boring machines, as well as machining centers, with up to 6 axes. You can also change the angular position of the spindle under program control.

Keyboard and screen layout are clearly arranged in such a way that the functions are fast and easy to use.



### HEIDENHAIN Klartext and DIN/ISO

HEIDENHAIN Klartext, the dialog-guided programming language for workshops, is an especially easy method of writing programs. Programming graphics illustrate the individual machining steps for programming the contour. If no NC-dimensioned drawing is available, then the FK free contour programming will help. Workpiece machining can be graphically simulated either during a test run or during a program run.

It is also possible to program in ISO format or DNC mode.

You can also enter and test one program while the control is running another.

### Compatibility

Machining programs created on HEIDENHAIN contouring controls (starting from the TNC 150 B) may not always run on the TNC 620. If the NC blocks contain invalid elements, the control will mark these as ERROR blocks or with error messages when the file is opened.



Please also note the detailed description of the differences between the iTNC 530 and the TNC 620.

**Further information:** "Functions of the TNC 620 and the iTNC 530 compared", page 806.



## 2.2 Visual display unit and operating panel

### Display screen

The control is available either as a compact version or with a separate display unit and operating panel. Both variants of the control come with a 15-inch TFT color flat-panel display.

#### 1 Header

When the control is on, the screen displays the selected operating modes in the header: The machine operating mode at left and the programming mode at right. The currently active mode is displayed in the larger field of the header, where the dialog prompts and messages also appear (exception: if the control only displays graphics).

#### 2 Soft keys

In the footer the control indicates additional functions in a soft-key row. You can select these functions by pressing the keys immediately below them. The thin bars immediately above the soft-key row indicate the number of soft-key rows that can be called with the keys to the right and left that are used to switch the soft keys. The bar representing the active soft-key row is blue.

#### 3 Soft-key selection keys

#### 4 Keys for switching the soft keys

#### 5 Setting the screen layout

#### 6 Key for switchover between machine operating modes, programming modes, and a third desktop

#### 7 Soft-key selection keys for machine tool builders

#### 8 Keys for switching the soft keys for machine tool builders

#### 9 USB connection

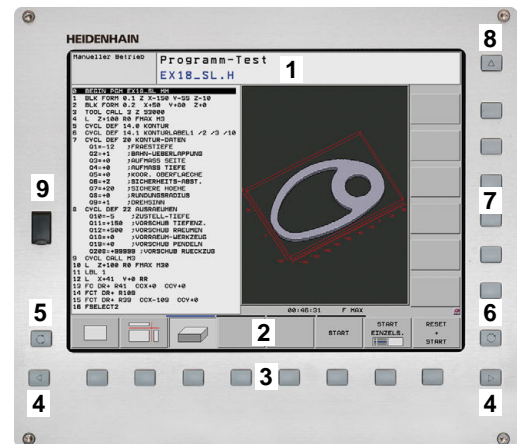
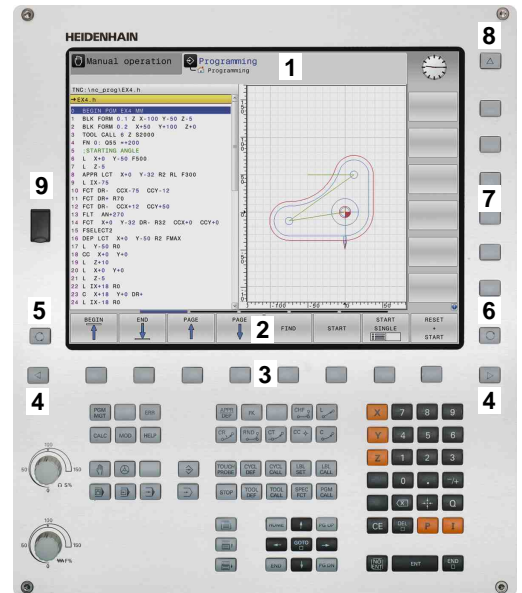

If you are using a TNC 620 with touch control, you can replace some keystrokes with hand-to-screen contact.

**Further information:** "Operating the Touchscreen", page 123

## Setting screen layout

The screen layout is user-selectable. In the **Programming** mode, for example, you can have the control show program blocks in the left window while the right window displays programming graphics. You could also display the program structure in the right window instead, or display only program blocks in one large window. The available screen windows depend on the selected operating mode.

Set up screen layout:



- ▶ Press the **screen layout** key: The soft-key row shows the available layout options

**Further information:** "Modes of operation", page 91

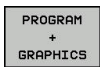

- ▶ Select the desired screen layout with a soft key

## Control panel

The TNC 620 is delivered with an integrated operating panel. As an alternative, the TNC 620 is also available with a separate display unit and an operating panel with an alphabetic keyboard.

- 1 Alphabetic keyboard for entering texts and file names, as well as for ISO programming
- 2 ■ File management
- Calculator
- MOD function
- HELP function
- Show error messages
- 3 Programming modes
- 4 Machine operating modes
- 5 Initiating programming dialogs
- 6 Navigation keys and **GOTO** jump command
- 7 Numerical input and axis selection
- 8 Touchpad
- 9 Mouse buttons
- 10 Machine operating panel

**More information** Machine manual

The functions of the individual keys are described on the inside front cover.



If you are using a TNC 620 with touch control, you can replace some keystrokes with hand-to-screen contact.

**Further information:** "Operating the Touchscreen", page 123



Refer to your machine manual.

Some machine tool builders do not use the standard HEIDENHAIN operating panel.

External keys, e.g. **NC START** or **NC STOP**, are described in your machine manual.

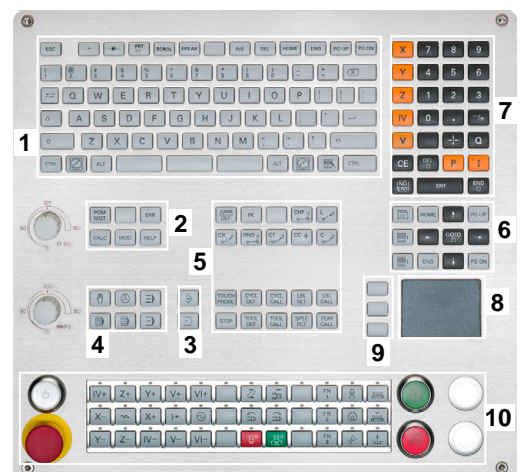
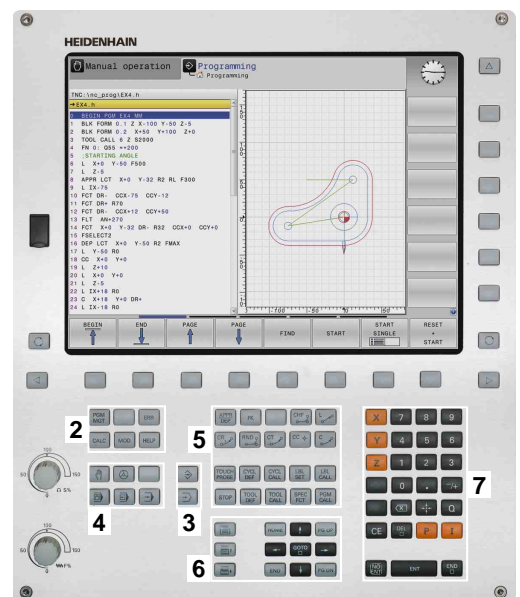

## 2.3 Modes of operation

### Manual Operation and El. Handwheel

The **Manual operation** mode is required for setting up the machine tool. In this mode of operation, you can position the machine axes manually or by increments, set the presets and tilt the working plane.

The **Electronic handwheel** mode of operation allows you to move the machine axes manually with the HR electronic handwheel.

#### Soft keys for the screen layout (select as described above)

Soft key	Window
POSITION	Positions
POSITION + STATUS	Left: positions, right: status display
POSITION + KINEMATICS	Left: positions, right: collision object

### Positioning with Manual Data Input

This mode of operation is used for programming simple traversing movements, such as for face milling or pre-positioning.

#### Soft keys for selecting the screen layout

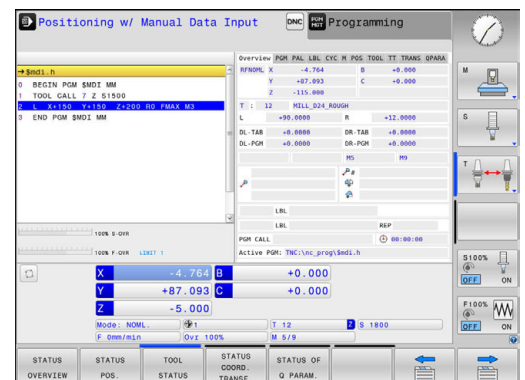
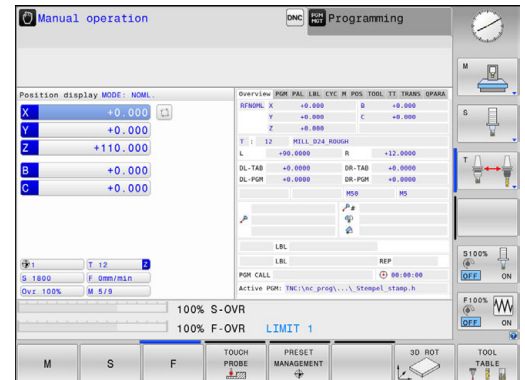

Soft key	Window
PGM	Program
PROGRAM + STATUS	Left: program, right: status display
POSITION + KINEMATICS	Left: program, right: collision object



## Programming

In this mode of operation you create NC programs. The FK free programming feature, the various cycles and the Q parameter functions help you with programming and add necessary information. If desired, you can have the programming graphics show the programmed paths of traverse.





### Soft keys for selecting the screen layout

Soft key	Window
	Program
	Left: program, right: program structure
	Left: program blocks, right: programming graphics

## Test Run

In the **Test Run** mode of operation, the control checks NC programs and program sections for errors, such as geometrical incompatibilities, missing or incorrect data within the program or violations of the working space. This simulation is supported graphically in different display modes. (Option 20)

### Soft keys for selecting the screen layout

Soft key	Window
	Program
	Left: program, right: status display
	Left: program, right: graphics (option 20)
	Graphic (Option 20)

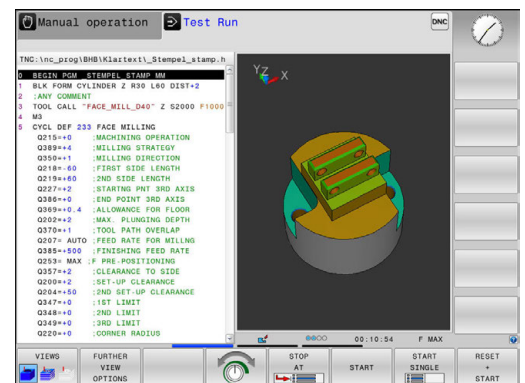
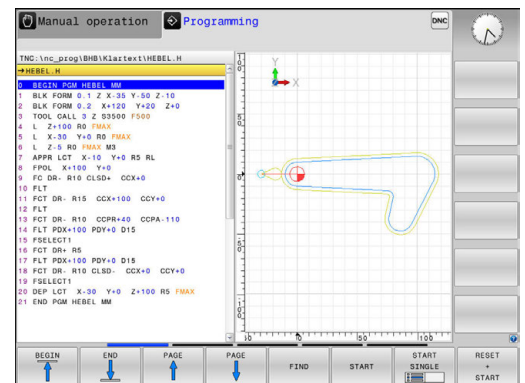

## Program Run, Full Sequence and Program Run, Single Block

In the **Program Run Full Sequence** mode, the control executes a program continuously to its end or to a manual or programmed stop. You can resume program run after an interruption.

In the **Program Run Single Block** mode, you execute each block separately by pressing the **NC start** key. With point pattern cycles and **CYCL CALL PAT** the controls stops after each point.

### Soft keys for selecting the screen layout

Soft key	Window
PGM	Program
PROGRAM +	Left: program, right: structure
PROGRAM +	Left: program, right: status display
PROGRAM +	Left: program, right: graphics (option 20)
GRAPHICS	Graphic (option 20)

### Soft keys for screen layout with pallet tables(option 22 Pallet management)

Soft key	Window
PALLET	Pallet table
PROGRAM +	Left: program, right: pallet table
PALLET +	Left: pallet table, right: status display
PALLET +	Left: pallet table, right: graphics

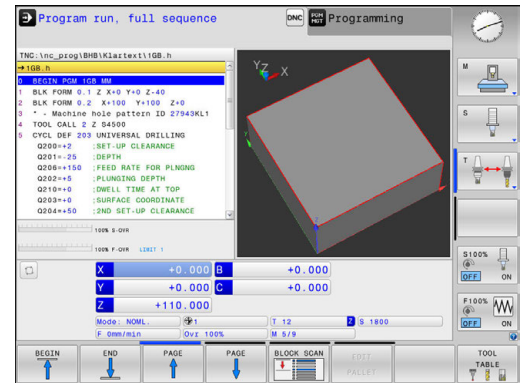

## 2.4 Status displays

### General status display

The general status display in the lower part of the screen informs you of the current state of the machine.

It is displayed automatically in the following operating modes:







- Program run, single block
- Program run, full sequence
- Positioning w/ Manual Data Input









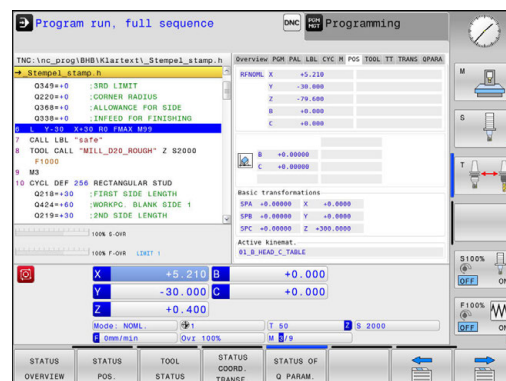

If the **GRAPHICS** screen layout is selected the status display is not shown.

In the **Manual operation** and **Electronic handwheel** modes the status display appears in the large window.

### Information in the status display

Icon	Meaning
<b>ACTL.</b>	Position display: Actual, nominal or distance-to-go coordinates mode
<b>XYZ</b>	Machine axes; the control displays auxiliary axes in lower-case letters. The sequence and quantity of displayed axes is determined by the machine tool builder. Refer to your machine manual for more information
	Number of the active preset from the preset table. If the preset was set manually, the control displays the text <b>MAN</b> behind the symbol
<b>F S M</b>	The displayed feed rate in inches corresponds to one tenth of the effective value. Spindle speed S, feed rate F and active M functions
	Axis is clamped
	Axis can be moved with the handwheel
	Axes are moving under a basic rotation
	Axes are moving under a 3-D basic rotation
	Axes are moving in a tilted working plane
	Axes are mirrored and moved
<b>TCPM</b>	The <b>M128</b> function or <b>FUNCTION TCPM</b> is active



Icon	Meaning
	The function for traversing in the tool-axis direction is active
	No program selected, program reselected, program aborted via internal stop or program terminated  In this condition the control has no modally effective program information (i.e. the contextual reference), so that all handling is possible, e.g. cursor movements or modification of Q parameters.
	Program started, execution runs  For safety reasons, the control permits no handling in this condition
	Program stopped, e.g. in operating mode <b>Program run, full sequence</b> after pressing the <b>NC stop</b> key  For safety reasons, the control permits no handling in this condition
	Program interrupted, e.g. in operating mode <b>Positioning w/ Manual Data Input</b> following the error-free execution of an NC block  In this condition the control permits various handling, e.g. cursor movements or the modification of Q parameters. With this handling the control may lose the modally effective program information (i.e. the contextual reference). Loss of this contextual reference may cause undesired tool positions!  <b>Further information:</b> "Programming and executing simple machining operations", page 694 and "Program-controlled interruptions", page 720
	Program aborted or terminated
<b>ACC</b>	The Active Chatter Control (ACC) function is active (option number 145)
S % 	Pulsing spindle speed function is active



The order of icons can be changed with the optional machine parameter **iconPrioList** (no. 100813). The control-in-operation symbol is always visible and cannot be configured.

## Additional status displays

The additional status displays contain detailed information on the program run. This can be called in all operating modes except for the **Programming** mode.

### To switch on the additional status display



- ▶ Call the soft key row for screen layout



- ▶ Select the layout option for the additional status display
- ▶ In the right half of the screen, the control shows the **Overview** status form.

### To select an additional status display



- ▶ Toggle through the soft key rows until the **STATUS** soft keys appear



- ▶ Either select the additional status display directly with the soft key, e.g. positions and coordinates; or



- ▶ use the switch-over soft keys to select the desired view

Select the status displays described below as follows:

- directly with the corresponding soft key
- via the switchover soft keys
- or by using the **next tab** key



Please note that some of the status information described below is not available unless the associated software option is enabled on your control.

### Overview

The **Overview** status form is displayed by the control following switch-on if you selected the screen layout **PROGRAM + STATUS** (or **POSITION + STATUS**). The overview form contains a summary of the most important status information, which you can also find on the various detail forms.

Soft key	Meaning
	Position display
	Tool information
	Active M functions
	Active coordinate transformations
	Active subprogram
	Active program section repeat
	Program called with <b>PGM CALL</b>
	Current machining time
	Name and path of the active main program

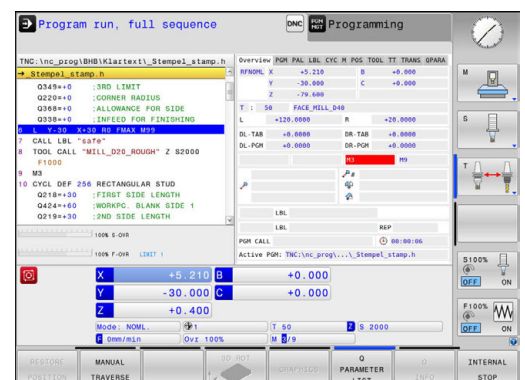



**General program information (PGM tab)**

Soft key	Meaning
No direct selection possible	Name and path of the active main program
	Actual/nominal value counter
	Circle center CC (pole)
	Dwell time counter
	Current machining time
	Current time
	Active programs

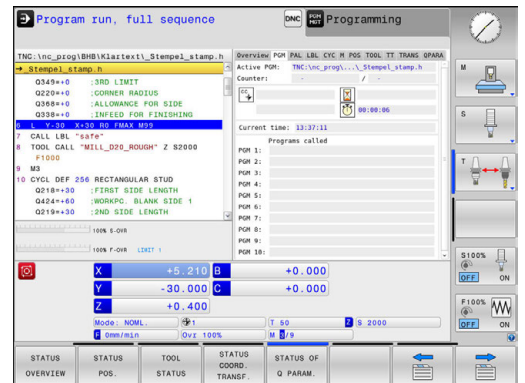

**Pallet information (PAL tab)**



The control displays this tab only if the function is active on your machine.

Soft key	Meaning
No direct selection possible	Number of the active pallet preset

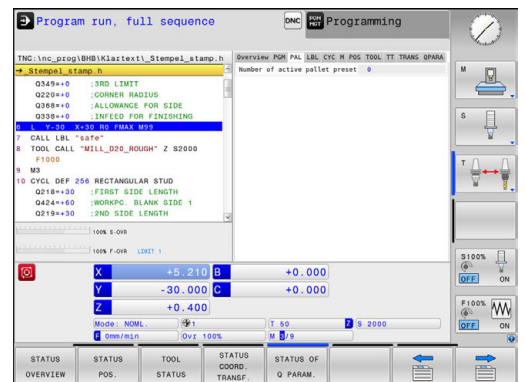

**Program section repeats and subprograms (LBL tab)**

Soft key	Meaning
No direct selection possible	Active program section repeats with block number, label number, and number of programmed repeats/repeats yet to be run
	Active subprograms with block number in which the subprogram was called and the label number that was called

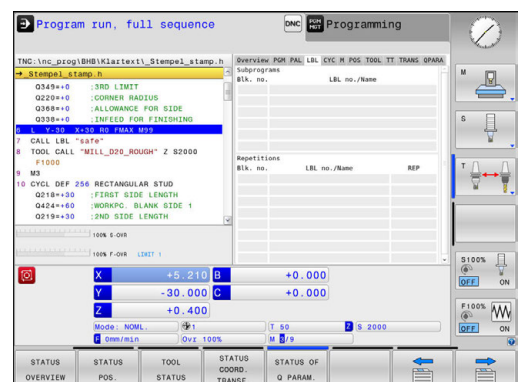

**Information on standard cycles (CYC tab)**

Soft key	Meaning
No direct selection possible	Active fixed cycle
	Active values of Cycle 32 Tolerance

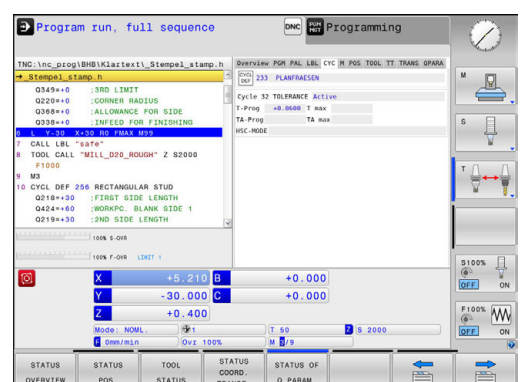

**Active miscellaneous functions M (M tab)**

Soft key	Meaning
No direct selection possible	List of the active M functions with fixed meaning
	List of the active M functions that are adapted by your machine manufacturer

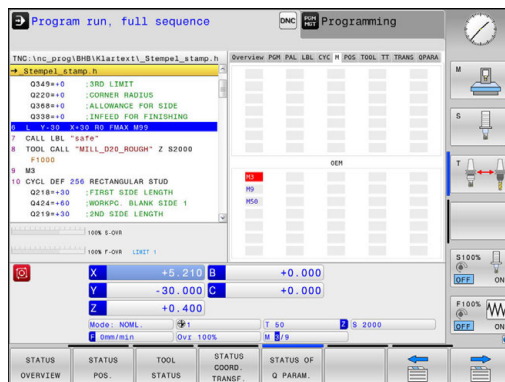

**Positions and coordinates (POS tab)**

Soft key	Meaning
<b>STATUS POS.</b>	Type of position display, e.g. actual position
	Tilt angle of the working plane
	Angle of basic transformations
	Active kinematics

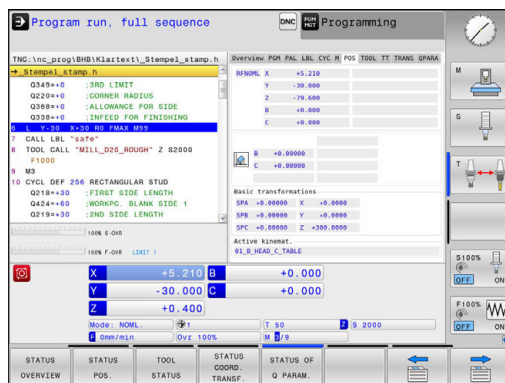

**Information on tools (TOOL tab)**

Soft key	Meaning
<b>TOOL STATUS</b>	Display of active tool: <ul style="list-style-type: none"> <li>T: Tool number and tool name</li> <li>RT: Number and name of a replacement tool</li> </ul>
	Tool axis
	Tool length and tool radii
	Oversizes (delta values) from the tool table (TAB) and the <b>TOOL CALL</b> (PGM)
	Tool life, maximum tool life (TIME 1) and maximum tool life for <b>TOOL CALL</b> (TIME 2)
	Display of programmed tool and replacement tool

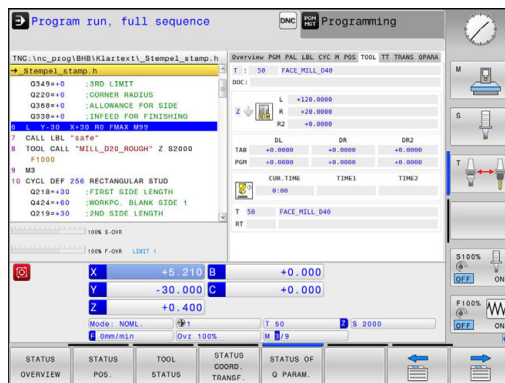

**Tool measurement (TT tab)**



The control displays this tab only if the function is active on your machine.

Soft key	Meaning
No direct selection possible	Active tool
	Measured values from tool measurement

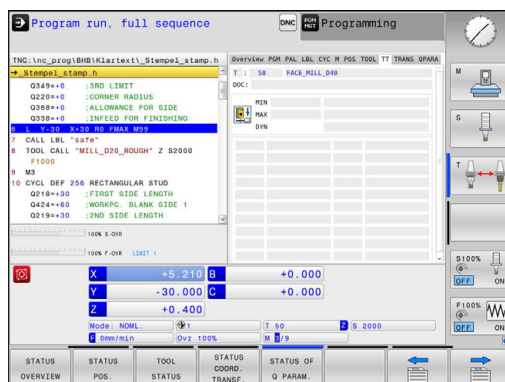

## Coordinate transformations (TRANS tab)

Soft key	Meaning
<b>STATUS COORD. TRANSF.</b>	Name of the active datum table
	Active datum number (#), comment from the active line of the active datum number (DOC) from Cycle 7
	Active datum shift (Cycle 7); the control displays an active datum shift in up to 8 axes
	Mirrored axes (Cycle 8)
	Active rotation angle (Cycle 10)
	Active scaling factor/factors (Cycle 11 / 26); the control displays an active scaling factor in up to 6 axes
	Scaling datum



In the optional machine parameter **CfgDisplayCoordSys** (no. 127501) you can specify the coordinate system in which the status display shows an active datum shift.

**Further information:** Cycle Programming User's Manual

## Displaying Q parameters (QPARA tab)

Soft key	Meaning
<b>STATUS OF Q PARAM.</b>	Display the current values of the defined Q parameters
	Display the character strings of the defined string parameters



Press the **Q PARAMETER LIST** soft key. The control opens a pop-up window. For each parameter type (Q, QL, QR, QS) define the parameter numbers you wish to control. Separate single Q parameters with a comma, and connect sequential Q parameters with a hyphen, e.g. 1,3,200-208. The input range per parameter type is 132 characters.

The display in the **QPARA** tab always contains eight decimal places. The result of  $Q1 = \cos 89.999$  is shown by the control as 0.00001745, for example. Very large and very small values are displayed by the control in exponential notation. The result of  $Q1 = \cos 89.999 * 0.001$  is shown by the control as +1.74532925e-08, whereby e-08 corresponds to the factor of  $10^{-8}$ .

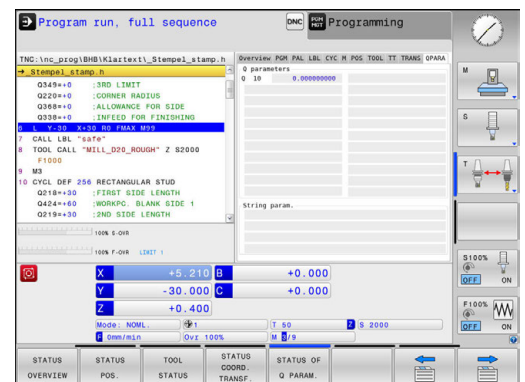
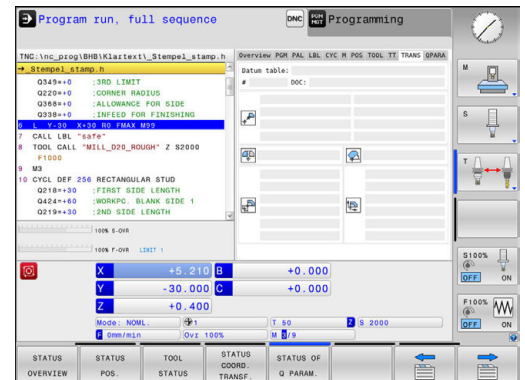

## 2.5 Window manager



Refer to your machine manual.

The machine tool builder determines the scope of function and behavior of the window manager.

The control features the Xfce window manager. Xfce is a standard application for UNIX-based operating systems, and is used to manage graphical user interfaces. The following functions are possible with the window manager:

- Display a task bar for switching between various applications (user interfaces)
- Manage an additional desktop, on which special applications from your machine manufacturer can run
- Control the focus between NC software applications and those of the machine manufacturer
- You can change the size and position of pop-up windows. It is also possible to close, minimize and restore pop-up windows



The control shows a star in the upper left of the screen if an application of the window manager or the window manager itself has caused an error. In this case, switch to the window manager and correct the problem. If required, refer to your machine manual.

## Overview of taskbar

In the task bar you can choose different workspaces by mouse click.

The control provides the following workspaces:

- Workspace 1: Active operating mode
- Workspace 2: Active programming mode
- Workspace 3: CAD-Viewer or applications of the machine tool builder (optionally available)
- Workspace 4: Display and remote control of external computer units (option 133) or applications of the machine tool builder (optionally available)

In addition, you can also select other applications from the task bar which you have started in parallel to the control software, e.g. the **TNCguide**.

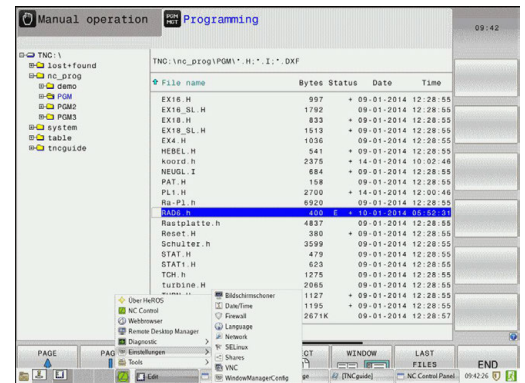

You can randomly move all open applications to the right of the green HEIDENHAIN symbol between the workspaces by pressing and holding the left mouse button.

Click the green HEIDENHAIN symbol to open a menu in which you can get information, make settings or start applications.

The following functions are available:

- **About HEROS:** Open information about the operating system of the control
- **NC Control:** Start and stop the control software (for diagnostic purposes only)
- **Web Browser:** Start the web browser
- **Touchscreen Calibration:** For calibrating the touch screen (only for touch operation)  
**Further information:** "Touchscreen Calibration", page 137
- **Touchscreen Configuration:** Adjust the screen properties (only for touch operation)  
**Further information:** "Touchscreen Configuration", page 137
- **Touchscreen Cleaning:** Lock the screen (only for touch operation)  
**Further information:** "Touchscreen Cleaning", page 138
- **Remote Desktop Manager** (option 133): Display and remote control of external computer units  
**Further information:** "Remote Desktop Manager (option 133)", page 115

- **Diagnostic:** Diagnostic applications
  - **GSmartControl:** Available only to authorized specialists
  - **HE Logging:** Define settings for internal diagnostic files
  - **HE Menu:** Available only to authorized specialists
  - **perf2:** Check processor load and process load
  - **Portscan:** Test active connections  
**Further information:** "Portscan", page 104
  - **Portscan OEM:** Available only to authorized specialists
  - **RemoteService:** Start and stop remote maintenance  
**Further information:** "Remote Service", page 105
  - **Terminal:** Enter and execute console commands
- **Settings:** Operating system settings
  - **Date/Time:** Set date and time
  - **Language/Keyboards:** Select system dialog language and keyboard version—the control overwrites the setting of the system dialog language when starting with the language setting of the machine parameter **CfgDisplayLanguage** (no. 101300)
  - **Network:** Define network settings
  - **Printer:** Configure and manage printer  
**Further information:** "Printer", page 107
  - **Screensaver:** Define screensaver
  - **SELinux:** Define safety software for Linux-based operating systems
  - **Shares:** Connect and manage external network drives
  - **VNC:** Define the setting for external software accessing the control for e.g. maintenance work (**V**irtual **N**etwork **C**omputing)  
**Further information:** "VNC", page 110
  - **WindowManagerConfig:** Available only to authorized specialists
  - **Firewall:** Configure the firewall  
**Further information:** "Firewall", page 763
  - **HePacketManager:** Available only to authorized specialists
  - **HePacketManager Custom:** Available only to authorized specialists

- **Tools:** File applications
  - **Document Viewer:** Display and print files, e.g. PDF files
  - **File Manager:** Available only to authorized specialists
  - **Geeqie:** Open, manage, and print graphics
  - **Gnumeric:** Open, edit, and print tables
  - **Keypad:** Open virtual keyboard
  - **Leafpad:** Open and edit text files
  - **NC/PLC Backup:** Create backup file  
**Further information:** "Backup and restore", page 112
  - **NC/PLC Restore:** Restore backup file  
**Further information:** "Backup and restore", page 112
  - **Ristretto:** Open graphics
  - **Screenshot:** Create screenshots
  - **TNCguide:** Call up help system
  - **Xarchiver:** Extract or compress directories
  - **Applications:** Supplementary applications
    - **Orage Calender:** Open calendar
    - **Real VNC viewer:** Define the setting for external software accessing the control for e.g. maintenance work (Virtual Network Computing)



The applications available under tools can be started directly by selecting the corresponding file type in the file management of the control

**Further information:** "Additional tools for management of external file types", page 184

## Portscan

The PortScan function enables the cyclic or manual searching for all open, incoming TCP and UDP list ports on the system. All ports found are compared with whitelists. If the control finds a non-listed port it shows a corresponding pop-up window.

The HeROS **Diagnostic** menu contains the **Portscan** and **Portscan OEM** applications for this purpose. **Portscan OEM** is only executable after entering the machine manufacturer password.

The **Portscan** function searches for all open, incoming TCP and UDP ports on the system and compares them to four whitelists stored in the system:

- System-internal whitelists **/etc/sysconfig/portscan-whitelist.cfg** and **/mnt/sys/etc/sysconfig/portscan-whitelist.cfg**
- Whitelist for ports with machine manufacturer-specific functions, e.g. for Python and DNC applications: **/mnt/plc/etc/sysconfig/portscan-whitelist.cfg**
- Whitelist for ports with customer-specific functions: **/mnt/tnc/etc/sysconfig/portscan-whitelist.cfg**

For each entry, the whitelist specifies the type of port (TCP/UDP), the port number, the providing program, and optional comments. If the automatic port scan function is active, only ports listed in the whitelists can be open. Non-listed ports trigger a notification window.

The result of the scan is saved to a log file (LOG:/portscan/scanlog and LOG:/portscan/scanlogevil), and if new ports are found that are not listed in one of the whitelists these are displayed.

### Manually starting Portscan

Proceed as follows to manually start the Portscan:

- ▶ Taskbar at the bottom edge of the screen  
**Further information:** "Window manager", page 100
- ▶ Press the green HEIDENHAIN button to open the JH menu
- ▶ Select the **Diagnostic** menu item
- ▶ Select the **Portscan** menu item
- > The control opens the **HeRos Portscan** pop-up window.
- ▶ Press the **Start** key

### Cyclically starting Portscan

Proceed as follows to automatically start the Portscan cyclically:

- ▶ Taskbar at the bottom edge of the screen  
**Further information:** "Window manager", page 100
- ▶ Press the green HEIDENHAIN button to open the JH menu
- ▶ Select the **Diagnostic** menu item
- ▶ Select the **Portscan** menu item
- > The control opens the **HeRos Portscan** pop-up window.
- ▶ Press the **Automatic update on** key
- ▶ Set the time interval with the slider



## Remote Service

Together with the Remote Service Setup Tool, the TeleService from HEIDENHAIN enables encrypted end-to-end connections to be established between a service computer and the machine tool.

To enable the HEIDENHAIN control to communicate with the HEIDENHAIN server it must be connected to the internet.

**Further information:** "Configuring the control", page 757

In its basic state the firewall of the control blocks all incoming and outgoing connections. For this reason the firewall must be deactivated for the duration of the service session.

### Setting up the control

To set up the control, proceed as follows:

- ▶ Taskbar at the bottom edge of the screen
  - Further information:** "Window manager", page 100
- ▶ Press the green HEIDENHAIN button to open the JH menu
- ▶ Select the **Settings** menu item
- ▶ Select the **Firewall** menu item
- > The control displays the **Firewall/SSH settings** dialog
- ▶ Deactivate the firewall by removing the **Active** option in the **Firewall** tab.
- ▶ Press the **Apply** button to save the settings
- ▶ Press the **OK** button
- > The firewall is disabled.

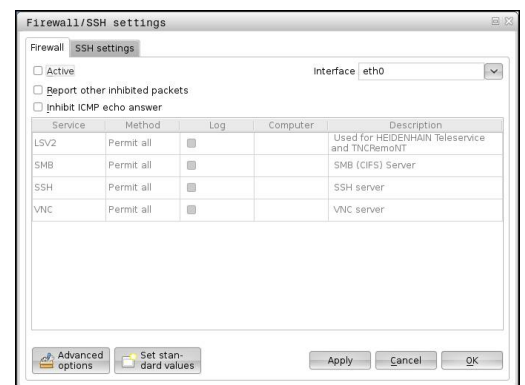

Do not forget to activate the firewall again after the end of the service session.

### Automatic installation of a session certificate

With an NC software installation a temporary certificate is automatically installed on the control. An installation, also in the form of an update, may only be carried out by a service technician from the machine tool builder.

### Manual installation of a session certificate

A new certificate must be installed if no valid session certificate is installed on the control. Clarify which certificate is needed with your service employee. He will then provide you with a valid certificate file if necessary.

To install the certificate on the control proceed as follows:

- ▶ Taskbar at the bottom edge of the screen
  - ▶ **Further information:** "Window manager", page 100
- ▶ Press the green HEIDENHAIN button to open the JH menu
- ▶ Select the **Settings** menu item
- ▶ Select the **Network** menu item
- ▶ The control displays the **Network settings** dialog
- ▶ Select the **Internet** tab. The settings in the **Remote maintenance** field are configured by the machine tool builder.
- ▶ Press the **Add** key and select the file from the menu
- ▶ Press the **Open** key
- ▶ The certificate is opened.
- ▶ Press the **OK** soft key
- ▶ It may be necessary to restart the control to load the settings

### Launching the service session

Proceed as follows to start the service session:

- ▶ Open the task bar at the bottom edge of the screen
- ▶ Press the green HEIDENHAIN button to open the JH menu
- ▶ Select the **Diagnostic** menu item
- ▶ Select the **RemoteService** menu item
- ▶ Enter the **Session key** of the machine tool builder

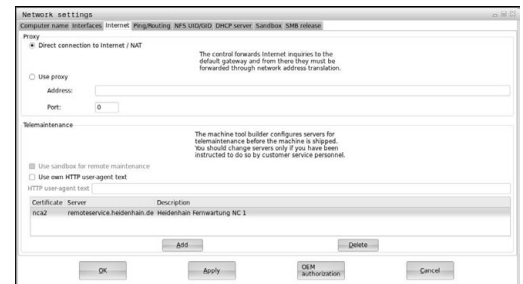

## Printer

The **Printer** function in the HeROS menu enables you to add and manage printers.

### Displaying the printer settings

Proceed as follows to access the printer settings:

- ▶ Open the task bar at the bottom edge of the screen  
**Further information:** "Window manager", page 100
- ▶ Press the green HEIDENHAIN button to open the JH menu
- ▶ Select the **Settings** menu item
- ▶ Select the **Printer** menu item
- > The control opens the **Heros Printer Manager** pop-up window.

The name of the printer is displayed in the input field.

Soft key	Meaning
CREATE	Creates the printer named in the input field
CHANGE	Modifies the properties of the selected printer
COPY	Creates the printer named in the input field with the attributes of the selected printer This can be useful if printing both portrait and landscape formats on the same printer
DELETE	Deletes the selected printer
UP	Selects the desired printer
DOWN	
STATUS	Displays status information of the selected printer
PRINT TEST PAGE	Prints a test page on the selected printer

For each printer, the following attributes can be set:

Setting	Meaning
Name of the printer	The printer name can be changed here.
Connection	Here, you can select the connection type <ul style="list-style-type: none"> <li>■ USB: The USB connection can be assigned here. The name is displayed automatically.</li> <li>■ Network: Enter the network name or the IP address of the target printer here. In addition, specify the port of the network printer here (default: 9100)</li> <li>■ Printer not connected</li> </ul>
Timeout	Defines the delay to printing after the last change has been made to the file to be printed in PRINTER:. This can be useful if the file to be printed is populated with data by using FN functions, e.g. during probing.
Standard printer	Select to define the standard printer in case several printers are available. Is defined automatically when creating the first printer.

Setting	Meaning
Settings for printing of text	These settings are applicable when printing text documents: <ul style="list-style-type: none"> <li>■ Paper size</li> <li>■ Number of copies</li> <li>■ Job name</li> <li>■ Font size</li> <li>■ Header</li> <li>■ Print options (black and white, color, duplex)</li> </ul>
Orientation	Portrait, landscape for all printable files
Expert options	Available only to authorized specialists

Print options:

- Copying of the file to be printed in PRINTER:  
The file to be printed is automatically forwarded to the standard printer and deleted from the directory after the print job has been executed
- Using the FN 16: F-PRINT function  
**Further information:** "Printing messages", page 391

List of printable files:

- Text files
- Graphic files
- PDF files



The connected printer must be PostScript-enabled.

## SELinux security software

**SELinux** is an extension for Linux-based operating systems. SELinux is an additional security software package based on Mandatory Access Control (MAC) and protects the system against the running of unauthorized processes or functions and therefore protects against viruses and other malware.

MAC means that every action must be explicitly permitted, otherwise it will not be executed by the control. The software is intended as protection in addition to the normal access restriction in Linux. Certain processes and actions can only be executed if the standard functions and access control of SELinux permit it.



The SELinux installation of the control has been prepared to permit running only programs installed with the HEIDENHAIN NC software. Other programs cannot be run with the standard installation.

The access control of SELinux under HEROS 5 is regulated as follows:

- The control executes only applications that are installed with the HEIDENHAIN NC software
- Files in connection with the security of the software (SELinux system files, HEROS 5 boot files, etc.) may only be changed by programs that are selected explicitly
- New files generated by other programs must never be executed
- USB data carriers cannot be deselected
- There are only two processes that are permitted to execute new files:
  - Starting a software update: A software update from HEIDENHAIN can replace or change system files
  - Starting the SELinux configuration: The configuration of SELinux is usually password-protected by your machine manufacturer; refer here to the relevant machine manual



HEIDENHAIN recommends activating SELinux because it provides additional protection against attacks from outside.

## VNC

Use the **VNC** function to configure the behavior of the various VNC clients. This includes, for example, operation via soft keys, mouse and the ASCII keyboard.

The control provides the following options:

- List of permitted clients (IP address or name)
- Password for the connection
- Additional server options
- Additional settings for assigning the focus



Refer to your machine manual.

For multiple clients or operating units, the focus assignment procedure depends on the design and the operating situation of the machine.

This function must be adapted by your machine manufacturer.

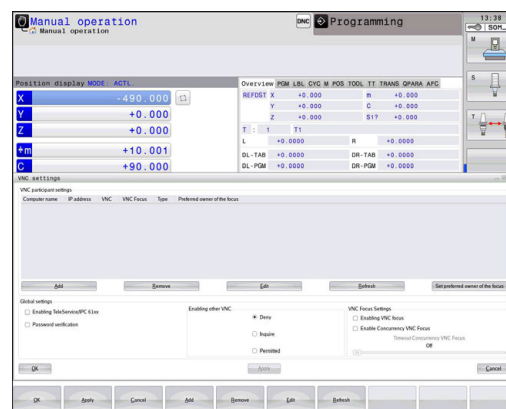

### Opening the VNC settings

Proceed as follows to open the VNC settings:



- ▶ Open the task bar at the bottom edge of the screen
  - Further information:** "Window manager", page 100
- ▶ Press the green HEIDENHAIN button to open the JH menu
- ▶ Select the **Settings** menu item
- ▶ Select the **VNC** menu item
- ▶ The control opens the **VNC Settings** pop-up window.

The control provides the following options:

- Add: Add new VNC viewer/client
- Remove: Deletes the selected client Only possible with manually entered clients.
- Edit: Edit the configuration of the selected client
- Update: Updates the display. Required with connection attempts during which the dialog is open.

### VNC settings

Dialog	Option	Meaning
VNC participant settings	<b>Computer name:</b>	IP address or computer name
	<b>VNC:</b>	Connection of the client to the VNC viewer
	<b>VNC Focus</b>	The client participates in the focus assignment
	<b>Type</b>	<ul style="list-style-type: none"> <li>■ Manual Manually entered client</li> <li>■ Denied This client is not permitted to connect</li> <li>■ TeleService/IPC 61xx Client via TeleService connection</li> <li>■ DHCP Other computer that obtains an IP address from this computer</li> </ul>

Dialog	Option	Meaning
Firewall warning		Warnings and information about if the VNC protocol has not been authorized for all VNC clients due to firewall settings on the control. <b>Further information:</b> "Firewall", page 763.
Global settings	<b>Enabling TeleService/IPC 61xx</b>	Connection via TeleService/IPC 61xx is always permitted
	<b>Password verification</b>	The client must enter a password for verification. If this option is active, the password must be entered when the connection is established.
Enabling other VNC	<b>Deny</b>	Access generally denied to all other VNC clients.
	<b>Inquire</b>	During connection attempts a corresponding dialog is opened.
	<b>Permitted</b>	Access is generally granted to all other VNC clients.
VNC Focus Settings	<b>Enabling VNC focus</b>	Enable focus assignment for this system. Otherwise there is no central focus assignment. In the default setting, the focus is actively reassigned by the owner of the focus by clicking the focus symbol. This means that the owner of the focus must first release the focus by clicking the focus symbol before any other client can retrieve the focus.
	<b>Enabling concurrency VNC focus</b>	In the default setting, the focus is actively reassigned by the owner of the focus by clicking the focus symbol. This means that the owner of the focus must first release the focus by clicking the focus symbol before any other client can retrieve the focus. If concurrency focus is selected, any client can retrieve the focus at any time without having to wait for the current owner of the focus to release it.
	<b>Timeout Concurrency VNC Focus</b>	Time period within which the current owner of the focus can object to the focus being withdrawn or can prevent the reassignment of the focus. If a client requests the focus, a dialog in which the reassignment of focus can be refused appears on all clients' screens.
Focus symbol		Current status of VNC focus on the respective client: Focus is owned by other client. Mouse and keyboard are disabled.
		Current status of VNC focus on respective client: Focus is owned by current client. Entries can be made.
		Current status of VNC focus on the respective client: Request by the owner of the focus to give the focus to another client. Mouse and keyboard are disabled until the focus is assigned unambiguously.

If **Enable concurrency VNC focus** is selected, a pop-up window appears. This dialog makes it possible to refuse that the focus be given to the requesting client. If this does not occur, the focus changes to the requesting client after the set time limit.

## Backup and restore

With the **NC/PLC Backup** and **NC/PLC Restore** functions you can back up and restore individual folders or the complete **TNC** drive. You can save the backup files locally, on a network drive, or to USB storage devices.

The backup program generates a \*. **tncbck** file that can also be processed by the PC tool TNCbackup (part of TNCremo). The restore program can restore these files as well as those from existing TNCbackup programs. If a \*. **tncbck** file is selected in the file manager of the control, the program **NC/PLC Restore** is automatically launched.

Backup and restore is subdivided into several steps. Navigate between these steps with the **FORWARD** and **BACK** soft keys. Specific actions for steps are selectively displayed as soft keys.

### Opening NC/PLC Backup or NC/PLC Restore

Proceed as follows to open the functions:

- ▶ Open the task bar at the bottom edge of the screen  
**Further information:** "Window manager", page 100
- ▶ Press the green HEIDENHAIN button to open the JH menu
- ▶ Select the **Tools** menu item
- ▶ Open the **NC/PLC Backup** or **NC/PLC Restore** menu item
- > The control opens the pop-up window.



**Backing up data**

To backup data from the control, proceed as follows:

- ▶ Select **NC/PLC Backup**
- ▶ Select the type
  - Back up the **TNC** partition
  - Back up the directory tree: Select the directory for backup in the file management
  - Back up the machine configuration (for machine tool builders only)
  - Complete backup (for machine tool builders only)
  - Comment: Freely configurable comment for the backup
- ▶ Select the next step with the **FORWARD** soft key
- ▶ Stop the control if required with the **STOP NC SOFTWARE** soft key
- ▶ Define the exclusion rules
  - User preset rules
  - Write own rules to the table
- ▶ Select the next step with the **FORWARD** soft key
- > The control generates a list of files for backing up.
- ▶ Check the list. Deselect files if necessary.
- ▶ Select the next step with the **FORWARD** soft key
- ▶ Enter the name of the backup file
- ▶ Select the storage path
- ▶ Select the next step with the **FORWARD** soft key
- > The control generates the backup file.
- ▶ Confirm with the **OK** soft key
- > The control concludes the backup process and restarts the NC software.

## Restoring data

### NOTICE

#### Caution: Data may be lost!

When you restore data (Restore function), any existing data will be overwritten without a confirmation prompt. Existing data is not automatically backed up by the control before running the restore process. Power failures or other problems can interfere with the data restore process. As a consequence, data may be irreversibly damaged or deleted.

- ▶ Before starting the data restore process, make a backup of the existing data

To restore the data proceed as follows:

- ▶ Select **NC/PLC Restore**
- ▶ Select the archive to be restored
- ▶ Select the next step with the **FORWARD** soft key
- > The control generates a list of files for restoring.
- ▶ Check the list. Deselect files if necessary.
- ▶ Select the next step with the **FORWARD** soft key
- ▶ Stop the control if required with the **STOP NC SOFTWARE** soft key
- ▶ Extract the archive
- > The control restores the files.
- ▶ Confirm with the **OK** soft key
- > The control restarts the NC software.

## 2.6 Remote Desktop Manager (option 133)

### Introduction

The Remote Desktop Manager enables you to display external computer units on the control screen that are connected via Ethernet, and to operate them via the control. You can also start programs specifically under HEROS or display web pages of an external server.

HEIDENHAIN offers you the IPC 6641 as a Windows computer. With the IPC 6641 Windows computer you can start and operate Windows-based applications directly from the control.

The following connection options are available:

- **Windows Terminal Server (RemoteFX):** Displays the desktop of a remote Windows computer on the control
- **VNC:** Connection to an external computer. Displays the desktop of a remote Windows or Unix computer on the control
- **Switch-off/restart of a computer:** Configure automatic shutdown of a Windows computer
- **World Wide Web:** Available only to authorized specialists
- **SSH:** Available only to authorized specialists
- **XDMCP:** Available only to authorized specialists
- **User-defined connection:** Available only to authorized specialists



HEIDENHAIN assures a functioning connection between HEROS 5 and the IPC 6641. No guarantee is given for other combinations and connections.



If you are using a TNC 620 with touch control, you can replace some keystrokes with hand-to-screen contact.

**Further information:** "Operating the Touchscreen", page 123

## Configuring connections – Windows Terminal Service (RemoteFX)

### Configuring an external computer



You do not need additional software for your external computer for connecting to the Windows Terminal Service.

Proceed as follows to configure the external computer, e.g. in the Windows 7 operating system:

- ▶ Press the Windows Start button and select **Control Panel** on the Start menu
- ▶ Select **System and Security**
- ▶ Select **System**
- ▶ Select **Remote settings**
- ▶ Under **Remote Assistance**, enable **Allow Remote Assistance connections to this computer**
- ▶ Under **Remote Desktop**, select **Allow connections from computers running any version of Remote Desktop**
- ▶ Press **OK** to confirm your settings

### Configuring the control

Proceed as follows to configure the control:

- ▶ Press the **DIADUR** key to open the HeROS menu
- ▶ Select **Remote Desktop Manager**
- > The control opens the **Remote Desktop Manager**.
- ▶ Press **New connection**
- ▶ Press **Windows Terminal Service (RemoteFX)**
- > The control opens the **Selection of server operating system** pop-up window.
- ▶ Select the desired operating system
  - Win XP
  - Win 7
  - Win 8.X
  - Win 10
  - Another Windows
- ▶ Press **OK**
- > The control opens the **Edit the connection** pop-up window.
- ▶ Edit the connection

Setting	Meaning	Input
<b>Connection name</b>	Name of the connection in the Remote Desktop Manager	Required
<b>Restarting after end of connection</b>	Behavior with terminated connection: <ul style="list-style-type: none"> <li>■ Always restart</li> <li>■ Never restart</li> <li>■ Always after an error</li> <li>■ Ask after an error</li> </ul>	Required
<b>Automatic starting upon login</b>	Connection automatically established during control power-up	Required
<b>Add to favorites</b>	Connection icon in the task bar: <ul style="list-style-type: none"> <li>▶ Single click with the left mouse button</li> <li>&gt; The control switches to the desktop of the connection.</li> <li>▶ Single click with the right mouse button</li> <li>&gt; The control displays the connection menu.</li> </ul>	Required
<b>Move to the following workspace</b>	Number of desktop for the connection, whereby desktops 0 and 1 are reserved for the NC software Default setting: Third desktop	Required
<b>Release USB mass memory</b>	Enable access to connected USB mass memory	Required
<b>Computer</b>	Host name or IP address of the external computer In the recommended configuration of the IPC 6641, the IP address 192.168.254.3 is used	Required
<b>User name</b>	Name of the user	Required
<b>Password</b>	User password	Required
<b>Windows domain</b>	Domain of the external computer	Optional
<b>Full screen mode or user-defined window size</b>	Size of the connection window	Required
Entries in the <b>Advanced options</b> area	Available only to authorized specialists	Optional

For integrating the IPC 6641, HEIDENHAIN recommends using a RemoteFX connection.

For RemoteFX, the screen of the external computer is not mirrored, as for VNC. Instead, a separate desktop is opened. The desktop that is active on the external computer when the connection is established is then locked and the user is logged off. This prevents that two users access the control simultaneously.

## Configuring the connection – VNC

### Configuring an external computer



You do not need an additional VNC server for your external computer for connecting to VNC.  
Install and configure the VNC server, e.g. the TightVNC server, before configuring the control.

### Configuring the control

Proceed as follows to configure the control:

- ▶ Press the **DIADUR** key to open the HeROS menu
- ▶ Select **Remote Desktop Manager**
- > The control opens the **Remote Desktop Manager**.
- ▶ Press **New connection**
- ▶ Press **VNC**
- > The control opens the **Edit the connection** pop-up window.
- ▶ Edit the connection

Setting	Meaning	Input
<b>Connection name:</b>	Name of the connection in the Remote Desktop Manager	Required
<b>Restarting after end of connection:</b>	Behavior with terminated connection: <ul style="list-style-type: none"> <li>■ Always restart</li> <li>■ Never restart</li> <li>■ Always after an error</li> <li>■ Ask after an error</li> </ul>	Required
<b>Automatic starting upon login</b>	Connection automatically established during control power-up	Required
<b>Add to favorites</b>	Connection icon in the task bar: <ul style="list-style-type: none"> <li>▶ Single click with the left mouse button</li> <li>&gt; The control switches to the desktop of the connection.</li> <li>▶ Single click with the right mouse button</li> <li>&gt; The control displays the connection menu.</li> </ul>	Required
<b>Move to the following workspace</b>	Number of desktop for the connection, whereby desktops 0 and 1 are reserved for the NC software Default setting: Third desktop	Required
<b>Release USB mass memory</b>	Permit access to connected USB mass memory	Required
<b>Calculator</b>	Host name or IP address of the external computer. In the recommended configuration of the IPC 6641, the IP address 192.168.254.3 is used	Required
<b>Password</b>	Password for connecting to the VNC server	Required

Setting	Meaning	Input
<b>Full-screen mode or User-defined window size:</b>	Size of the connection window	Required
<b>Permit further connections (share)</b>	Enable access to the VNC server also by other VNC connections	Required
<b>View only</b>	The external computer cannot be operated in display mode	Required
Entries in the <b>Advanced options</b> area	Available only to authorized specialists	Optional

With VNC, the screen of the external computer is mirrored directly. The active desktop on the external computer is not locked automatically.

With a VNC connection, it is also possible to completely shut down the external computer via the Windows menu. As the computer cannot be rebooted over a connection, it must actually be switched off and on again.

## Shutting down or rebooting an external computer

### NOTICE

#### Caution: Data may be lost!

If the external computer is not shut down properly, data may be irreversibly damaged or deleted.

- ▶ Configure automatic shutdown of the Windows computer

Proceed as follows to configure the control:

- ▶ Press the **DIADUR** key to open the HeROS menu
- ▶ Select **Remote Desktop Manager**
- > The control opens the **Remote Desktop Manager**.
- ▶ Press **New connection**
- ▶ Press **Switch-off/restart of a computer**
- > The control opens the **Edit the connection** pop-up window.
- ▶ Edit the connection

Setting	Meaning	Input
<b>Connection name:</b>	Name of the connection in the Remote Desktop Manager	Required
<b>Restarting after end of connection:</b>	Not necessary with this connection	–
<b>Automatic starting upon login</b>	Not necessary with this connection	–
<b>Add to favorites</b>	Connection icon in the task bar: <ul style="list-style-type: none"> <li>▶ Single click with the left mouse button</li> <li>&gt; The control switches to the desktop of the connection.</li> <li>▶ Single click with the right mouse button</li> <li>&gt; The control displays the connection menu.</li> </ul>	Required
<b>Move to the following workspace</b>	Not active with this connection	–

Setting	Meaning	Input
Release USB mass memory	Not advisable with this connection	–
Calculator	Host name or IP address of the external computer. In the recommended configuration of the IPC 6641, the IP address 192.168.254.3 is used	Required
User name	User name with which the connection should be logged on	Required
Password	Password for connecting to the VNC server	Required
Windows domain:	Domain of the target computer, if required	Optional
Max. waiting time (seconds):	When the control shuts down, it commands the Windows computer to shut down. Before the control displays the message <b>You may switch off now</b> , it waits for <b>&lt;Timeout&gt;</b> seconds. If the Windows computer is switched off before the <b>&lt;Timeout&gt;</b> seconds have expired, the control stops waiting.	Required
Force	If Force is not selected, Windows waits up to 20 seconds. This delays the shutdown process or the Windows computer is switched off before Windows has shut down.	Required
Restart	Reboot the Windows computer.	Required
Run during restart	Reboot the Windows computer when the control reboots. Effective only if the control is rebooted using the shutdown icon at the bottom right in the taskbar or if a reboot is initiated as a result of a change in the system settings (e.g. network settings).	Required
Run during switch-off	The Windows computer is switched off when the control is shut down (no reboot). This is the standard scenario. The <b>END</b> key will then no longer trigger a reboot, either.	Required
Entries in the <b>Advanced options</b> area	Available only to authorized specialists	Optional

## Starting and stopping the connection

Once a connection has been configured, it is shown as an icon in the Remote Desktop Manager window. Click the connection icon with the right mouse key to open a menu in which the display can be started and stopped.

Use the right DIADUR key on the keyboard to change to the third desktop and back to the control interface. You can also use the task bar to get to this desktop.

If the desktop of the external connection or the external computer is active, all inputs from the mouse and the keyboard are transmitted there.

When the HEROS 5 operating system is shut down, all connections are canceled automatically. Please note, however, that only the connection is canceled, whereas the external computer or the external system is not shut down automatically.

**Further information:** "Shutting down or rebooting an external computer", page 119



## 2.7 Accessories: HEIDENHAIN 3-D touch probes and electronic handwheels

### 3-D touch probes (Touch Probe Functions software option)

Applications for HEIDENHAIN 3-D touch probes:

- Automatically align workpieces
- Quickly and precisely set presets
- Measure the workpiece during program run
- Measure and inspect tools



All of the cycle functions (touch probe cycles and fixed cycles) are described in the Cycle Programming User's Manual. If you need this user's manual, please contact HEIDENHAIN if required. ID: 1096886-xx

#### Touch trigger probes TS 260, TS 444, TS 460, TS 642 and TS 740

The TS 248 and TS 260 touch probes are particularly cost-effective and transmit the trigger signals via a cable.

The wireless TS 740 and TS 642 touch probes as well as the smaller TS 460 and TS 444 touch probes are suitable for use on machines with tool changers. All of the above touch probes feature infrared signal transmission. TS 460 also supports wireless transmission and offers optional collision protection. Thanks to an integrated air turbine generator, the TS 444 touch probe is battery-free.

HEIDENHAIN touch trigger probes feature either a wear-resistant optical switch or several high-precision pressure sensors (TS 740) that detect the deflection of the stylus. On deflection, a trigger signal is generated, which causes the control to store the current position of the touch probe as the actual value.

#### Tool touch probes TT 160 and TT 460

The TT 160 and TT 460 touch probes are designed for the efficient and precise measurement and inspection of tool dimensions.

The control offers cycles that enable you to determine the tool length and radius while the spindle is rotating or stationary. The tool touch probe features a particularly rugged design and a high degree of protection, which make it insensitive to coolants and swarf.

A wear-resistant optical switch generates the trigger signal. With the TT 160, signal transmission is by cable. The TT 460 supports infrared and radio transmission.



## HR electronic handwheels

Electronic handwheels facilitate moving the axis slides precisely by hand. A wide range of traverses per handwheel revolution is available. Apart from the HR 130 and HR 150 integral handwheels, HEIDENHAIN also offers the HR 510, HR 520 and HR 550FS portable handwheels.

**Further information:** "Traverse with electronic handwheels", page 627



Several electronic handwheels can also be connected simultaneously and used alternatively on controls with the **(HSCI: HEIDENHAIN Serial Controller Interface)** serial interface for control components. Configuration is performed via the machine tool builder.



# 3

**Operating the  
Touchscreen**

## 3.1 Display unit and operation

### Touchscreen



Refer to your machine manual.

This feature must be enabled and adapted by the machine tool builder.

The touchscreen is distinguished by a black frame and the lack of soft-key selection keys.

The TNC 620 has its operating panel integrated in the 19" screen.

#### 1 Header

When the control is on, the screen displays the selected operating modes in the header.

#### 2 Soft-key row for the machine tool builder

#### 3 Soft-key row

The control shows further functions in a soft-key row. The active soft-key row is shown as a blue bar.

#### 4 Integrated operating panel



## Operating panel

### Integrated operating panel

The operating panel is integrated in the screen. The content of the operating panel changes depending on the current operating mode.

- 1 Area for showing the following:
  - Alphabetic keyboard
  - HeROS menu
  - Potentiometer for the speed of simulation (only in the **Test Run** operating mode)
- 2 Machine operating modes
- 3 Programming modes
 

The control shows the active operating mode, to which the screen is switched, with a green background.

The control shows the operating mode in the background through a small white triangle.
- 4
  - File management
  - Calculator
  - MOD function
  - HELP function
  - Show error messages
- 5 Rapid access menu
 

Depending on the operating mode, you'll find the most important functions here at a glance.
- 6 Opening the programming dialogs (only in the **Programming** and **Positioning w/ Manual Data Input** operating modes)
- 7 Numerical input and axis selection
- 8 Navigation
- 9 Arrows and the jump statement **GOTO**
- 10 Task bar

**Further information:** "Icons of the taskbar", page 136

In addition, the machine tool builder supplies a machine operating panel.



Refer to your machine manual.

External keys, e.g. **NC START** or **NC STOP**, are described in your machine manual.

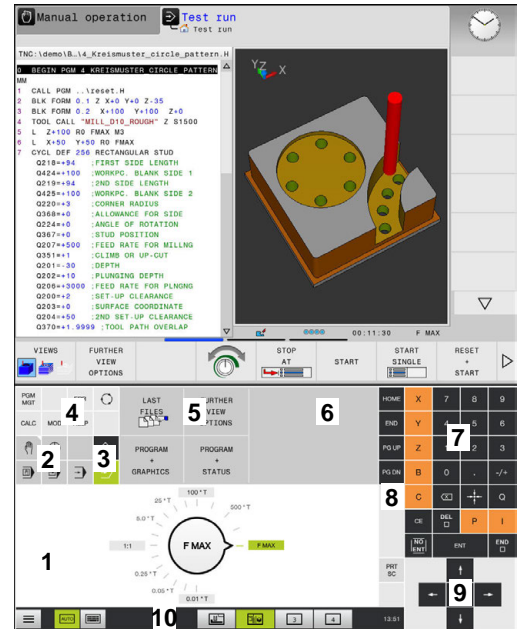



Operating panel of the Test Run mode



Operating panel in the Manual Operation mode

**Basic operation**





The following keys, for example, can easily be replaced by hand gestures:



Key	Function	Gesture
	Switch between operating modes	Tap on the operating mode in the header
	Shift the soft-key row	Swipe horizontally over the soft-key row
	Soft-key selection keys	Tap on the function in the touchscreen

### 3.2 Gestures

#### Overview of possible gestures



The screen of the control is multi-touch capable. That means that it can distinguish various gestures, including with two or more fingers at once.

Symbol	Gesture	Meaning
	Tap	A brief touch by a finger on the screen
	Double tap	Two brief touches on the screen
	Long press	Continuous contact of fingertip on the screen
	Swipe	Flowing motion over the screen
	Drag	A combination of long-press and then swipe, moving a finger over the screen when the starting point is clearly defined

Symbol	Gesture	Meaning
	Two-finger drag	A combination of long-press and then swipe, moving two fingers in parallel over the screen when the starting point is clearly defined
	Spread	Two fingers long-press and move away from each other
	Pinch	Two fingers move toward each other

### Navigating in the table and NC programs

You can navigate in an NC program or a table as follows:

Symbol	Gesture	Function
	Tap	Mark the NC block or table line Stop scrolling
	Double tap	Activate the table line
	Swipe	Scroll through the NC program or table







### Operating the simulation

The control offers touch operation with the following graphics:

- Programming graphics in the **Programming** mode of operation
- 3-D view in the **Test Run** operating mode
- 3-D view in the **Program Run Single Block** operating mode
- 3-D view in the **Program Run Full Sequence** operating mode
- Kinematics view

#### Rotate, zoom or move a graphic

The control supports the following gestures:

Symbol	Gesture	Function
	Double tap	Set the graphic to its original size
	Drag	Rotate the graphic (only 3-D graphics)
	Two-finger drag	Move graphics
	Spread	Magnify the graphic
	Pinch	Reduce the graphic



### Measure the graphic

If you have activated measurement in the **Test Run** operating mode, you have the following additional functions:

Symbol	Gesture	Function
	Tap	Select the measuring point

### Using the HEROS menu



You can use the HEROS menu as follows:

Symbol	Gesture	Function
	Tap	Select the application
	Long press	Open the application

### Operating the CAD viewer



The control also supports touch operation for working with the **CAD-Viewer**. You have various gestures available depending on the operating mode.



To be able to use all applications, first use the icon to select the desired function:

Icon	Function
	Default setting
	<b>Add</b> Works in the selection mode like a pressed <b>Shift</b> key
	<b>Remove</b> Works in the selection mode like a pressed <b>CTRL</b> key

### Layer setting mode and specify the workpiece preset

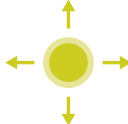

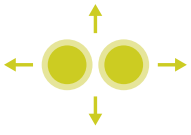
The control supports the following gestures:

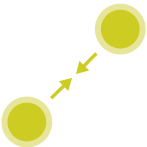

Symbol	Gesture	Function
	Tap on an element	Show element information Specify the workpiece preset
	Double-tap on the background	Set the graphic or 3-D model to its original size
	Activate <b>Add</b> and double-tap on the background	Reset the graphic or 3-D model to its original size and angle
	Drag	Rotate the graphic or 3-D model (only in the Layer Setting mode)

Symbol	Gesture	Function
	Two-finger drag	Move a graphic or 3-D model
	Spread	Enlarge a graphic or 3-D model
	Pinch	Reduce a graphic or 3-D model

### Selecting a contour



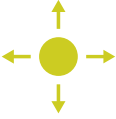
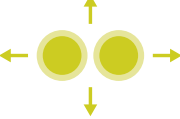
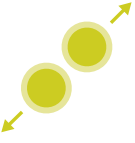
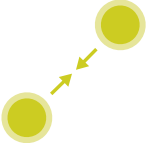

The control supports the following gestures:

Symbol	Gesture	Function
	Tap on an element	Select element
	Tap on an element in the list-view window	Select or deselect an element
	Activate <b>Add</b> and tap on an element	Part, shorten, or lengthen and element

Symbol	Gesture	Function
	Activate <b>Remove</b> and tap on an element	Deselect an element
	Double-tap on the background	Reset the graphic to its original size
	Swipe over an element	Show a preview of selected elements Show element information
	Two-finger drag	Move graphics
	Spread	Magnify the graphic
	Pinch	Reduce the graphic

### Selecting machining positions

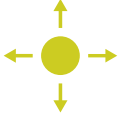
The control supports the following gestures:

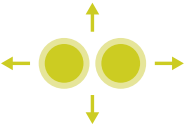
Symbol	Gesture	Function
	Tap on an element	Select element Selecting an intersection
	Double-tap on the background	Reset the graphic to its original size
	Swipe over an element	Show a preview of selected elements Show element information
	Activate <b>Add</b> and drag	Spread a fast selection area
	Activate <b>Remove</b> and drag	Spread an area for deselection of elements
	Two-finger drag	Move graphics

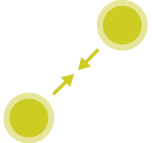
Symbol	Gesture	Function
	Spread	Magnify the graphic
	Pinch	Reduce the graphic

### Save elements and switch to the NC program

When you tap on the appropriate icons, the controls saves the selected elements.







You have three ways to switch back to the **Programming** operating mode:

- Press the **Programming** machine operating mode key  
The control switches to the **Programming** mode of operation.
- Close the **CAD-Viewer**  
The control automatically switches to the **Programming** mode of operation.
- Use the task bar to leave the **CAD-Viewer** open on the third desktop  
The third desktop stays active in the background

### 3.3 Functions in the taskbar

#### Icons of the taskbar

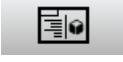
The taskbar provides you with the following icons:



Icon	Function
	Opens the HeROS menu
	Automatically shows and hides the keyboard
	Always shows the keyboard
	Workspace 1: Select the active machine mode
	Workspace 2: Select the active programming mode
	Workspace 3: Select the CAD viewer, DXF converter or applications of the machine tool builder (optionally available)
	Workspace 4: Select the display and remote control of external computer units (option 133) or applications of the machine tool builder (optionally available)

#### Functions in the HeROS menu

Using the **Menu** icon on the taskbar, you can open the HeROS menu through which you can find information, make settings or start applications.

**Further information:** "Overview of taskbar", page 101

The taskbar provides you with the following icons:

Icon	Function
	Return to main menu
	Show active applications
	Show all applications



If you have set the view to active applications, you can close specific applications as in a task manager.





## Touchscreen Calibration

With the **Touchscreen Calibration** function you can measure and correct the screen.

### Calibrating the touchscreen

Proceed as follows to conduct the functions:

- ▶ or the **menu** icon to open the HeROS menu
- ▶ Select the **Touchscreen Calibration** menu item
- > The control starts the calibration mode.
- ▶ Successively tap on the blinking symbols

If you would like to stop the calibration:

- ▶ Wait until the screen switches again or press **ESC** on the connected keyboard

## Touchscreen Configuration

With the **Touchscreen Configuration** function you can define the properties of the screen.

### Adjusting sensitivity

Proceed as follows to adjust the sensitivity:

- ▶ or the **menu** icon to open the HeROS menu
- ▶ Select the **Touchscreen Configuration** menu item
- > The control opens a pop-up window.
- ▶ Select the sensitivity
- ▶ Confirm with **OK**

### Display of the touch points

Proceed as follows to show or hide the touch points:

- ▶ Press the **DIADUR** key to open the JH menu
- ▶ Select the **Touchscreen Configuration** menu item
- > The control opens a pop-up window.
- ▶ Select the **Show Touch Points** display
  - **Disable Touchfingers** to hide the touch points
  - **Enable Single Touchfinger** to show the touch point
  - **Enable Full Touchfingers** to show the touch points of all fingers involved
- ▶ Confirm with **OK**

## Touchscreen Cleaning

With the **Touchscreen Cleaning** function you can lock the screen in order to clean it.

### Activating the cleaning mode

Proceed as follows to change activate the cleaning mode:

- ▶ through the **menu** icon to open the HeROS menu
- ▶ Select the **Touchscreen Cleaning** menu item
- > The control locks the screen for 90 seconds.
- ▶ Clean the screen

If you would like to stop the cleaning mode:

- ▶ Pull the displayed sliders apart at the same time

# 4

**Fundamentals,  
File Management**

## 4.1 Fundamentals

### Position encoders and reference marks

The machine axes are equipped with position encoders that register the positions of the machine table or tool. Linear axes are usually equipped with linear encoders, rotary tables and tilting axes with angle encoders.

When a machine axis moves, the corresponding position encoder generates an electrical signal. The control evaluates this signal and calculates the precise actual position of the machine axis.

If there is a power interruption, the calculated position will no longer correspond to the actual position of the machine slide. To recover this assignment, incremental position encoders are provided with reference marks. The scales of the position encoders contain one or more reference marks that transmit a signal to the control when they are crossed over. This enables the control to re-establish the assignment of the displayed position to the current machine position. For linear encoders with distance-coded reference marks, the machine axes need to move by no more than 20 mm, for angle encoders by no more than 20°.

With absolute encoders, an absolute position value is transmitted to the control immediately upon switch-on. In this way the assignment of the actual position to the machine slide position is re-established directly after switch-on.

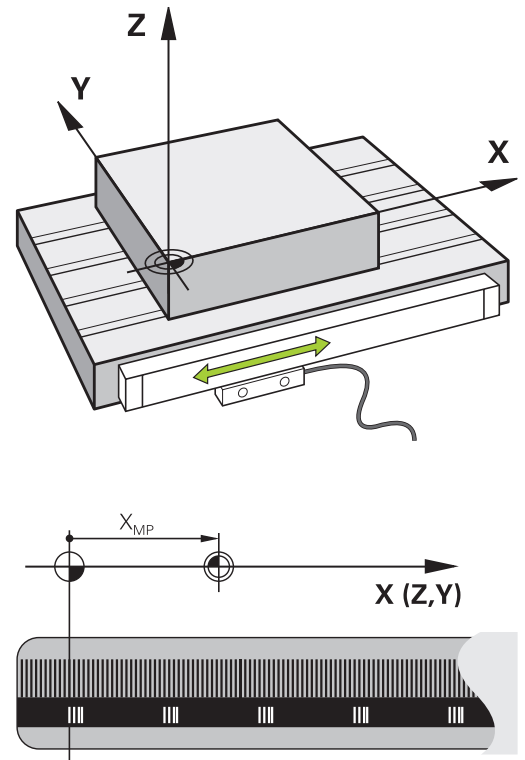

## Reference systems

For the control to traverse an axis according to a defined path it requires a **reference system**.

A paraxially mounted linear encoder on a machine tool serves as a simple reference system for linear axes. The linear encoder represents a **number ray**, a unidimensional coordinate system.

To approach a point on the **plane**, the control requires two axes and therefore a reference system with two dimensions.

To approach a point in the **space**, the control requires three axes and therefore a reference system with three dimensions. If these three axes are configured perpendicular to each other this creates a so-called **three-dimensional Cartesian coordinate system**.

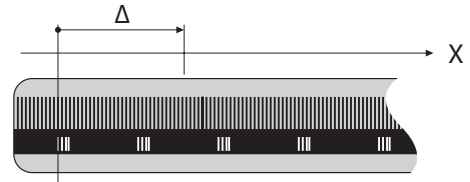

According to the right-hand rule the fingertips point in the positive directions of the three main axes.

For a point to be uniquely determined in space, a **coordinate origin** is needed in addition to the configuration of the three dimensions. The common intersection serves as the coordinate origin in a 3-D coordinate system. This intersection has the coordinates **X+0, Y+0** and **Z+0**.

The control must differentiate between various reference systems for it to always perform a tool change at the same position for example, or carry out a machining operation always related to the current workpiece position.

The control differentiates between the following reference systems:

- Machine coordinate system M-CS:  
**M**achine **C**oordinate **S**ystem
- Basic coordinate system B-CS:  
**B**asic **C**oordinate **S**ystem
- Workpiece coordinate system W-CS:  
**W**orkpiece **C**oordinate **S**ystem
- Working plane coordinate system WPLCS:  
**W**orking **P**lane **C**oordinate **S**ystem
- Input coordinate system I-CS:  
**I**nterface **C**oordinate **S**ystem
- Tool coordinate system T-CS:  
**T**ool **C**oordinate **S**ystem



All reference systems build up on each other. They are subject to the kinematic chain of the specific machine tool.

The machine coordinate system is the reference system.

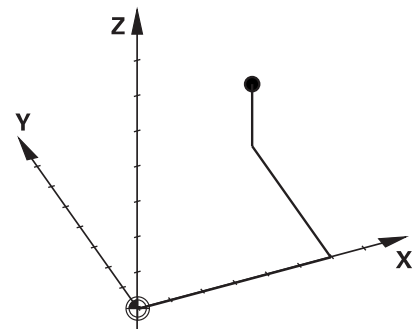
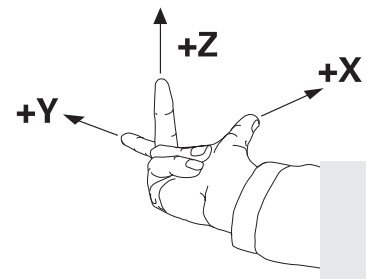

### Machine coordinate system M-CS

The machine coordinate system corresponds to the description of kinematics and therefore to the actual mechanical design of the machine tool.

Because the mechanics of a machine tool never precisely correspond to a Cartesian coordinate system, the machine coordinate system consists of several one-dimensional coordinate systems. These one-dimensional coordinate systems correspond to the physical machine axes that are not obligatorily perpendicular to each other.

The position and orientation of the one-dimensional coordinate systems are defined with the aid of translations and rotations based on the spindle tip in the description of kinematics.

The position of the coordinate origin, the so-called machine datum, is defined by the machine manufacturer during machine configuration. The values in the machine configuration define the zero positions of the encoders and the corresponding machine axes. The machine datum does not necessarily have to be located in the theoretical intersection of the physical axes. It can therefore also be located outside of the traverse range.

Because the machine configuration values cannot be modified by the user, the machine coordinate system is used for determining constant positions, e.g. the tool change point.

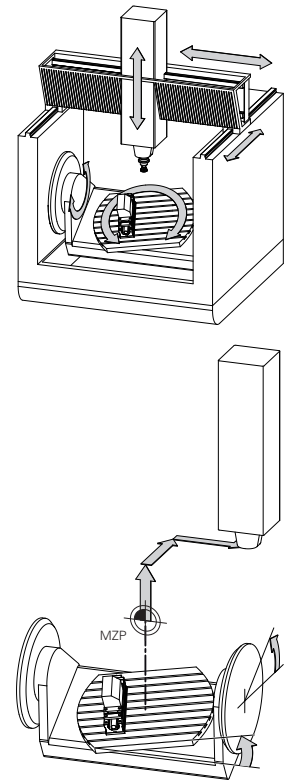

Machine datum (MCP)

Soft key	Application
<div style="border: 1px solid black; padding: 2px; width: fit-content;">           BASE TRANSFORM. OFFSET         </div>	The user can define shifts in the machine coordinate system according to the specific axis with use of the <b>OFFSET</b> values of the preset table.



The machine tool builder configures the **OFFSET** columns of the preset management in accordance with the machine.

**Further information:** "Managing presets", page 644

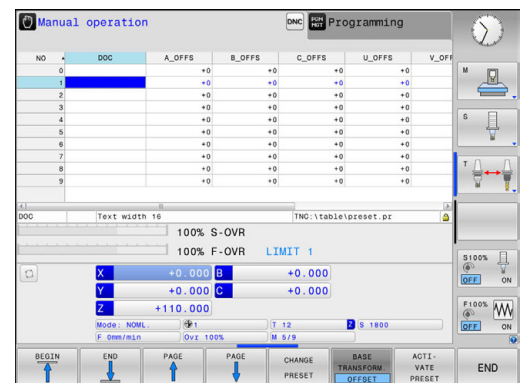

## NOTICE

### Danger of collision!

Your control may feature an additional pallet preset table, depending on the machine. In this table the machine tool builder can define **OFFSET** values that take effect before the **OFFSET** values you specify in the preset table become effective. The **PAL** tab of the expanded status display indicates whether a pallet preset is active, and which one. Since the **OFFSET** values of the pallet preset table are neither visible nor editable, there is a risk of collision during any movement!

- ▶ Refer to the machine tool builder's documentation
- ▶ Use pallet presets only in conjunction with pallets
- ▶ Check the display of the **PAL** tab before you start machining



Another feature is **OEM-OFFSET**, which is available only to the machine tool builder. **OEM-OFFSET** can be used to define additive axis shifts for rotary and parallel axes.

All **OFFSET** values (from all the above **OFFSET** input possibilities) together difference between the **ACTL.** and the **RFACTL** position of an axis.

The control converts all movements in the machine coordinate system, independent of the reference system used for value input.

Example of a 3-axis machine tool with a Y axis as oblique axis, not arranged perpendicularly to the ZX plane:

- ▶ In the **Positioning w/ Manual Data Input** operating mode, run an NC block with **L IY+10**
- > The control determines the required axis nominal values from the defined values.
- > During positioning the control moves the **Y and Z** machine axes.
- > The **RFACTL** and **RFNOML** displays show movements of the Y axis and Z axis in the machine coordinate system.
- > The **ACTL.** and **NOML.** displays only show one movement of the Y axis in the input coordinate system.
- ▶ In the **Positioning w/ Manual Data Input** operating mode, run an NC block with **L IY-10 M91**
- > The control determines the required axis nominal values from the defined values.
- > During positioning the control only moves the **Y** machine axis.
- > The **RFACTL** and **RFNOML** displays only show one movement of the Y axis in the machine coordinate system.
- > The **ACTL.** and **NOML.** displays show movements of the Y axis and Z axis in the input coordinate system.

The user can program positions related to the machine datum, e.g. by using the miscellaneous function **M91**.

### Basic coordinate system B-CS

The basic coordinate system is a 3-D Cartesian coordinate system. Its coordinate origin is the end of the kinematics model.

The orientation of the basic coordinate system in most cases corresponds to that of the machine coordinate system. There may be exceptions to this if a machine manufacturer uses additional kinematic transformations.

The kinematic model and thus the position of the coordinate origin for the basic coordinate system is defined by the machine manufacturer in the machine configuration. The user cannot modify the machine configuration values.

The basic coordinate system serves to determine the position and orientation of the workpiece coordinate system.

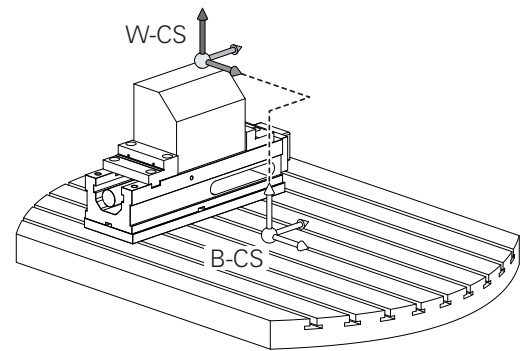

Soft key      Application

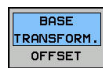

The user determines the position and orientation of the workpiece coordinate system by using a 3-D touch probe for example. The control saves the values determined with respect to the basic coordinate system as **BASE TRANSFORM.** values in the preset management.



The machine tool builder configures the **BASE TRANSFORM.** columns of the preset management in accordance with the machine.

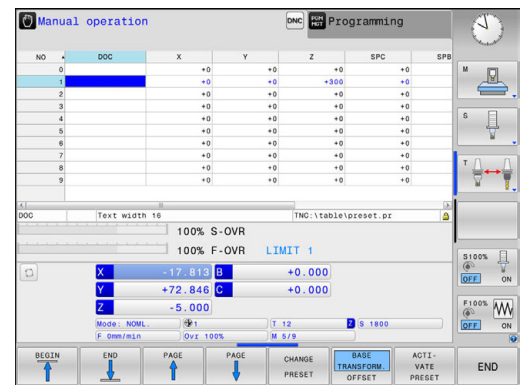

**Further information:** "Managing presets", page 644

## NOTICE

### Danger of collision!

Your control may feature an additional pallet preset table, depending on the machine. In this table the machine tool builder can define **BASE TRANSFORM.** values that take effect before the **BASE TRANSFORM.** values you specify in the preset table become effective. The **PAL** tab of the expanded status display indicates whether a pallet preset is active, and which one. Since the **BASE TRANSFORM.** values of the pallet preset table are neither visible nor editable, there is danger of collision during all movements!

- ▶ Refer to the machine tool builder's documentation
- ▶ Use pallet presets only in conjunction with pallets
- ▶ Check the display of the **PAL** tab before you start machining



**Workpiece coordinate system W-CS**

The workpiece coordinate system is a 3-D Cartesian coordinate system. Its coordinate origin is the active preset.

The position and orientation of the workpiece coordinate system depend on the **BASE TRANSFORM.** values of the active line in the preset table.

Soft key	Application
	The user determines the position and orientation of the workpiece coordinate system by using a 3-D touch probe for example. The control saves the values determined with respect to the basic coordinate system as <b>BASE TRANSFORM.</b> values in the preset management.

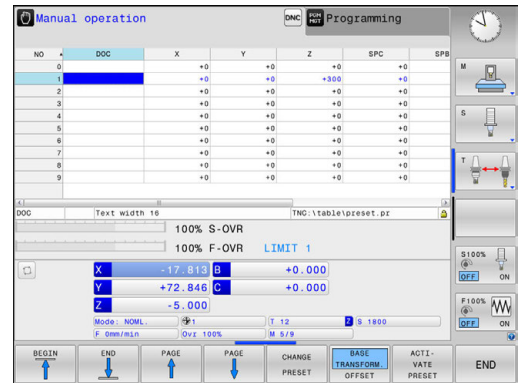

**Further information:** "Managing presets", page 644

In the workpiece coordinate system the user defines the position and orientation of the working plane coordinate system with use of transformations.

Transformations in the workpiece coordinate system:

- **3D ROT** functions
  - **PLANE** functions
  - Cycle 19 **WORKING PLANE**
- Cycle 7 **DATUM SHIFT**  
(shifting **before** tilting the working plane)
- Cycle 8 **MIRROR IMAGE**  
(mirroring **before** tilting the working plane)

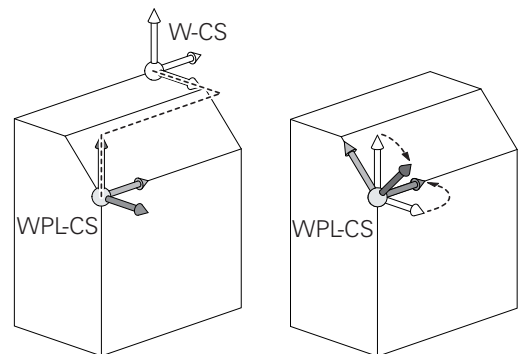
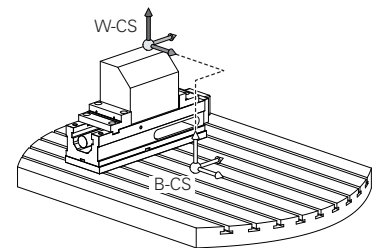

**i** The result of transformations built up on each other depends on the programming sequence. In every coordinate system, program only the specified (recommended) transformations. This applies to both setting and resetting the transformations. Any other use may lead to unexpected or undesired results. Please observe the following programming notes.

Programming notes:

- Transformations (mirroring and shifting) that are programmed before the **PLANE** functions (except for **PLANE AXIAL**) will change the position of the tilt datum (origin of the working plane coordinate system WPL-CS) and the orientation of the rotary axes
  - If you just program a shift, then only the position of the tilt datum will change
  - If you just program mirroring, then only the orientation of the rotary axes will change
- When used in conjunction with **PLANE AXIAL** and Cycle 19, the programmed transformations (mirroring, rotation and scaling) do not affect the position of the tilt datum or the orientation of the rotary axes



Without active transformations in the workpiece coordinate system, the position and orientation of the working plane coordinate system and workpiece coordinate system are identical.

There are no transformations in the workpiece coordinate system on 3-axis machine tools or with pure 3-axis machining. The **BASE TRANSFORM.** values of the active line of the preset table have a direct effect on the working plane coordinate system with this assumption.

Other transformations are of course possible in the working plane coordinate system. **Further information:** "Working plane coordinate system WPL-CS", page 147

### Working plane coordinate system WPL-CS

The working plane coordinate system is a 3-D Cartesian coordinate system.

The position and orientation of the working plane coordinate system depend on the active transformations in the workpiece coordinate system.

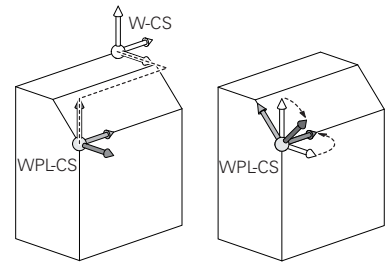

Without active transformations in the workpiece coordinate system, the position and orientation of the working plane coordinate system and workpiece coordinate system are identical.

There are no transformations in the workpiece coordinate system on 3-axis machine tools or with pure 3-axis machining. The **BASE TRANSFORM.** values of the active line of the preset table have a direct effect on the working plane coordinate system with this assumption.

In the working plane coordinate system the user defines the position and orientation of the input coordinate system with use of transformations.

Transformations in the working plane coordinate system:

- Cycle 7 **DATUM SHIFT**
- Cycle 8 **MIRROR IMAGE**
- Cycle 10 **ROTATION**
- Cycle 11 **SCALING**
- Cycle 26 **AXIS-SPECIFIC SCALING**
- **PLANE RELATIVE**

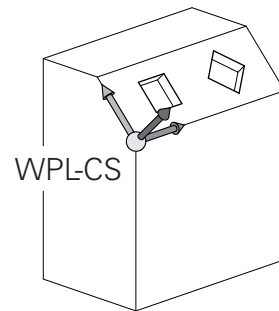

As a **PLANE** function, the **PLANE RELATIVE** is effective in the workpiece coordinate system and aligns the working plane coordinate system.

The values of additive tilting always relate to the current working plane coordinate system.

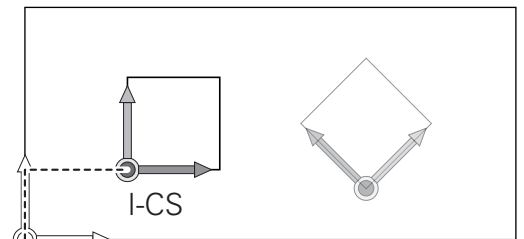

The result of transformations built up on each other depends on the programming sequence.



Without active transformations in the working plane coordinate system, the position and orientation of the input coordinate system and working plane coordinate system are identical.

There are also no transformations in the workpiece coordinate system on 3-axis machine tools or with pure 3-axis machining. The **BASE TRANSFORM.** values of the active line of the preset table have a direct effect on the input coordinate system with this assumption.

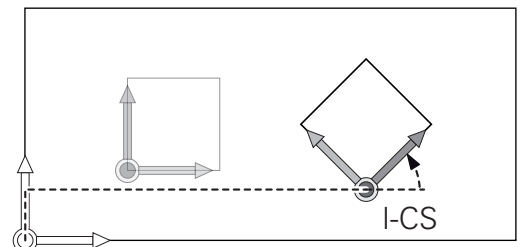

### Input coordinate system I-CS

The input coordinate system is a 3-D Cartesian coordinate system. The position and orientation of the input coordinate system depend on the active transformations in the working plane coordinate system.

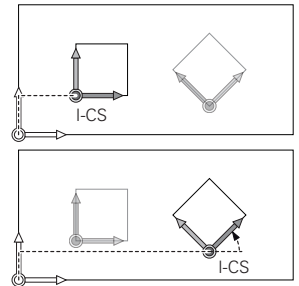
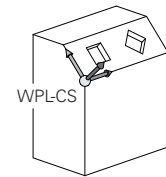

Without active transformations in the working plane coordinate system, the position and orientation of the input coordinate system and working plane coordinate system are identical.

There are also no transformations in the workpiece coordinate system on 3-axis machine tools or with pure 3-axis machining. The **BASE TRANSFORM.** values of the active line of the preset table have a direct effect on the input coordinate system with this assumption.

With the aid of positioning blocks in the input coordinate system, the user defines the position of the tool and therefore the position of the tool coordinate system.



The **NOML.**, **ACTL.**, **LAG** and **ACTDST** displays are also based on the input coordinate system.

Positioning blocks in input coordinate system:

- Paraxial positioning blocks
- Positioning blocks with Cartesian or polar coordinates
- Positioning blocks with Cartesian coordinates and surface normal vectors

### Example

```
7 X+48 R+
```

```
7 L X+48 Y+102 Z-1.5 R0
```

```
7 LN X+48 Y+102 Z-1.5 NX-0.04658107 NY0.00045007
NZ0.8848844 R0
```



The position of the tool coordinate system is determined by the Cartesian coordinates X, Y and Z also for positioning blocks with surface normal vectors.

In conjunction with 3-D tool compensation, the position of the tool coordinate system can be shifted along the surface normal vectors.



Orientation of the tool coordinate system can be performed in various reference systems.

**Further information:** "Tool coordinate system T-CS", page 149

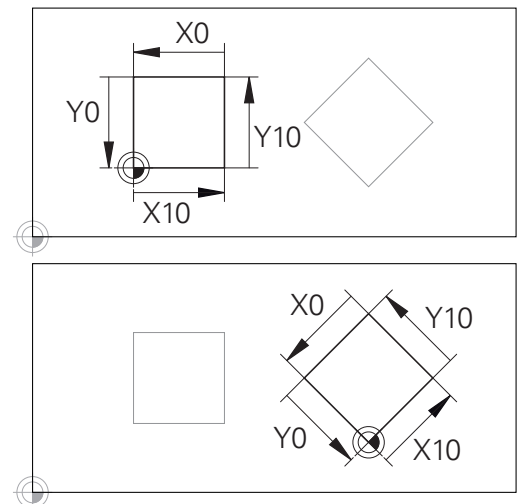

A contour referencing the input coordinate system origin can easily be transformed any way you need.

### Tool coordinate system T-CS

The tool coordinate system is a 3-D Cartesian coordinate system. Its coordinate origin is the tool reference point. The values of the tool table, **L** and **R** with milling tools and **ZL**, **XL** and **YL** with turning tools, reference this point.

**Further information:** "Entering tool data into the table", page 234

In accordance with the values from the tool table, the coordinate origin of the tool coordinate system is shifted to the tool center point TCP. TCP stands for **T**ool **C**enter **P**oint.

If the NC program does not reference the tool tip, the tool center point must be shifted. The required shift is implemented in the NC program using the delta values during a tool call.

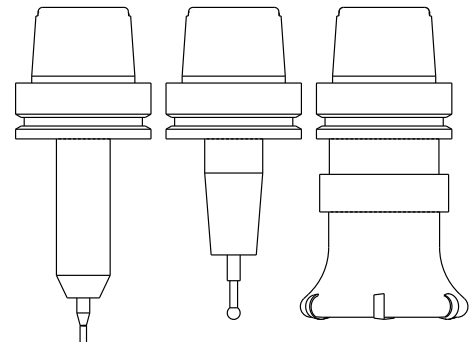

The position of the TCP as shown in the diagram is obligatory in conjunction with the 3-D tool compensation.



With the aid of positioning blocks in the input coordinate system, the user defines the position of the tool and therefore the position of the tool coordinate system.

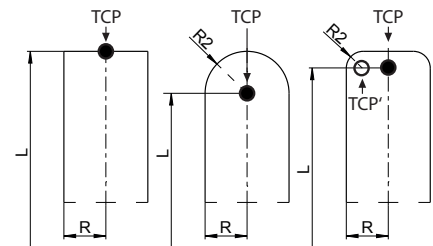

If the **TCPM** function or miscellaneous function **M128** is active, the orientation of the tool coordinate system depends on the tool's current angle of inclination.

The user defines the tool's angle of inclination either in the machine coordinate system or in the working plane coordinate system.

Tool angle of inclination in the machine coordinate system:

#### Example

**7 L X+10 Y+45 A+10 C+5 R0 M128**

Tool angle of inclination in the working plane coordinate system:

#### Example

**6 FUNCTION TCPM F TCP AXIS SPAT PATHCTRL AXIS**

**7 L A+0 B+45 C+0 R0 F2500**

**7 LN X+48 Y+102 Z-1.5 NX-0.04658107 NY0.00045007  
NZ0.8848844 TX-0.08076201 TY-0.34090025 TZ0.93600126 R0  
M128**

**7 LN X+48 Y+102 Z-1.5 NX-0.04658107 NY0.00045007  
NZ0.8848844 R0 M128**

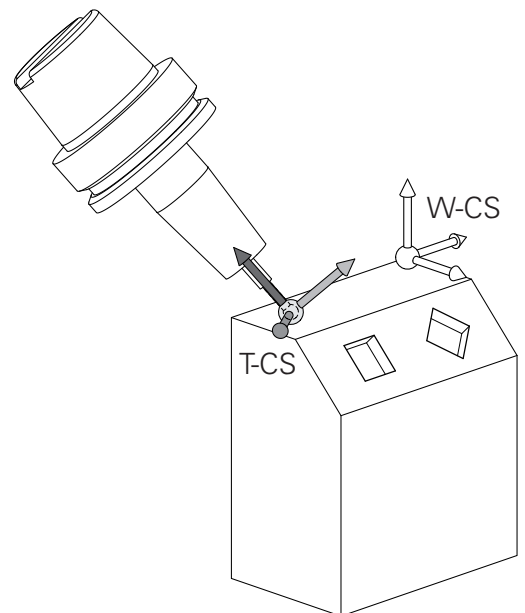

**i** With the shown positioning blocks with vectors, 3-D tool compensation is possible with compensation values **DL**, **DR** and **DR2** from the **TOOL CALL** block.

The methods of function of the compensation values depend on the type of tool.

The control detects the various tool types with the columns **L**, **R** and **R2** of the tool table:

- $R2_{TAB} + DR2_{TAB} + DR2_{PROG} = 0$   
→ end mill
- $R2_{TAB} + DR2_{TAB} + DR2_{PROG} = R_{TAB} + DR_{TAB} + DR_{PROG}$   
→ radius cutter or ball cutter
- $0 < R2_{TAB} + DR2_{TAB} + DR2_{PROG} < R_{TAB} + DR_{TAB} + DR_{PROG}$   
→ toroid cutter or toroidal cutter

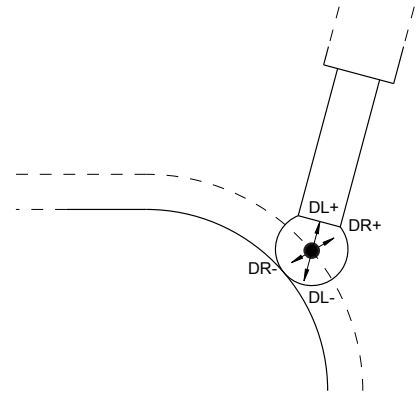

**i** Without the **TCPM** function or miscellaneous function **M128**, orientation of the tool coordinate system and input coordinate system is identical.

### Designation of the axes on milling machines

The X, Y and Z axes on your milling machine are also referred to as tool axis, principal axis (1st axis) and secondary axis (2nd axis). The assignment of the tool axis is decisive for the assignment of the principal and secondary axes.

Tool axis	Principal axis	Secondary axis
X	Y	Z
Y	Z	X
Z	X	Y

### Polar coordinates

If the production drawing is dimensioned in Cartesian coordinates, you also write the NC program using Cartesian coordinates. For parts containing circular arcs or angles it is often simpler to give the dimensions in polar coordinates.

While the Cartesian coordinates X, Y and Z are three-dimensional and can describe points in space, polar coordinates are two-dimensional and describe points in a plane. Polar coordinates have their datum at a circle center (CC), or pole. A position in a plane can be clearly defined by the:

- Polar Radius, the distance from the circle center CC to the position, and the
- Polar Angle, the value of the angle between the angle reference axis and the line that connects the circle center CC with the position.

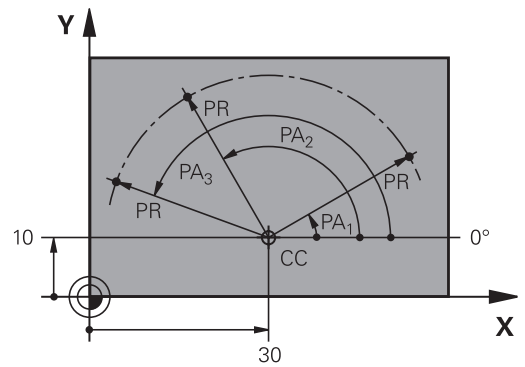

### Setting the pole and the angle reference axis

The pole is set by entering two Cartesian coordinates in one of the three planes. These coordinates also set the reference axis for the polar angle PA.

Coordinates of the pole (plane)	Reference axis of the angle
X/Y	+X
Y/Z	+Y
Z/X	+Z

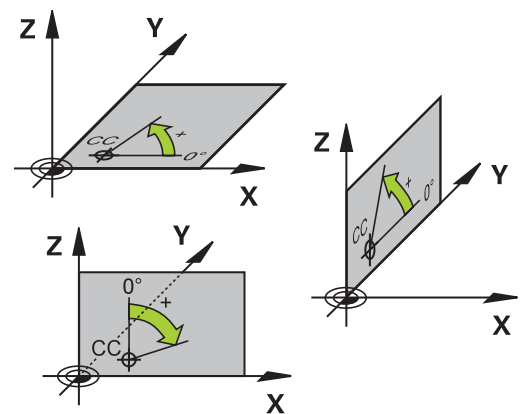

## Absolute and incremental workpiece positions

### Absolute workpiece positions

Absolute coordinates are position coordinates that are referenced to the datum of the coordinate system (origin). Each position on the workpiece is unambiguously defined by its absolute coordinates.

Example 1: Holes dimensioned in absolute coordinates

Hole 1	Hole 2	Hole 3
X = 10 mm	X = 30 mm	X = 50 mm
Y = 10 mm	Y = 20 mm	Y = 30 mm

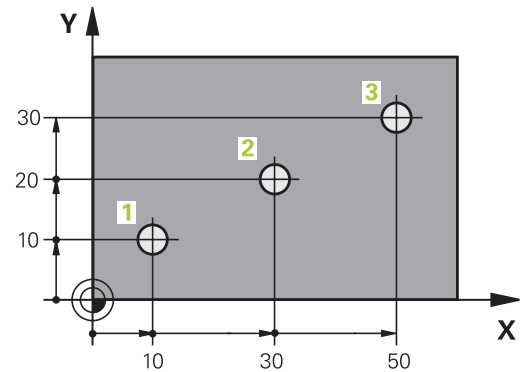

### Incremental workpiece positions

Incremental coordinates are referenced to the last programmed nominal position of the tool, which serves as the relative (imaginary) datum. When you write an NC program in incremental coordinates, you thus program the tool to move by the distance between the previous and the subsequent nominal positions. This is why they are also referred to as chain dimensions.

To program a position in incremental coordinates, enter the letter I before the axis.

Example 2: Holes dimensioned in incremental coordinates

Absolute coordinates of hole 4

X = 10 mm

Y = 10 mm

Hole 5, with respect to 4      Hole 6, with respect to 5

X = 20 mm      X = 20 mm

Y = 10 mm      Y = 10 mm

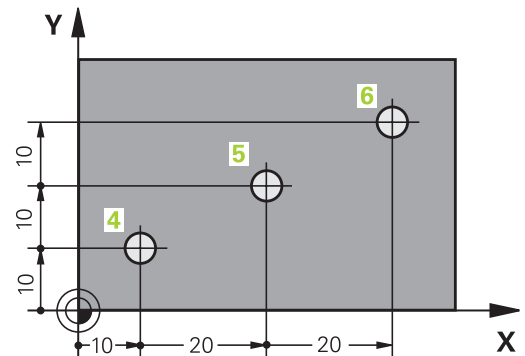

### Absolute and incremental polar coordinates

Absolute coordinates always refer to the pole and the angle reference axis.

Incremental polar coordinates always refer to the last programmed nominal position of the tool.

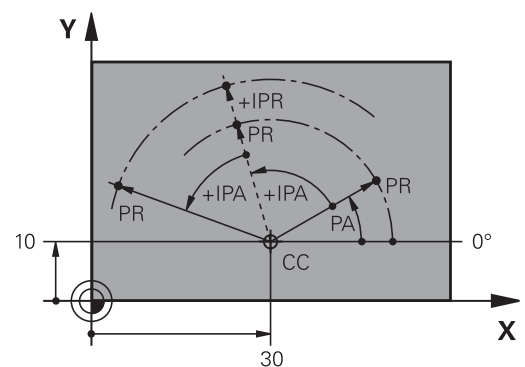



## Selecting the preset

A production drawing identifies a certain form element of the workpiece, usually a corner, as the absolute preset (datum). When setting the preset, you first align the workpiece along the machine axes, and then move the tool in each axis to a defined position relative to the workpiece. Set the display of the control either to zero or to a known position value for each position. This establishes the reference system for the workpiece, which will be used for the control's display and your part program.

If the production drawing is dimensioned in relative presets, simply use the coordinate transformation cycles.

**Further information:** Cycle Programming User's Manual

If the production drawing is not dimensioned for NC, set the preset at a position or corner on the workpiece from which the dimensions of the remaining workpiece positions can be measured.

The fastest, easiest and most accurate way of presetting is by using a 3-D touch probe from HEIDENHAIN.

**Further information:** "Presetting with a 3-D touch probe (option number 17)", page 676

### Example

The workpiece drawing shows holes (1 to 4), whose dimensions are shown with respect to an absolute preset with the coordinates  $X=0$   $Y=0$ . The coordinates of holes 5 to 7 refer to the relative preset with the absolute coordinates  $X=450$   $Y=750$ . By using the **Datum shift** cycle you can shift the datum temporarily to the position  $X=450$ ,  $Y=750$  and program the holes (5 to 7) without further calculations.

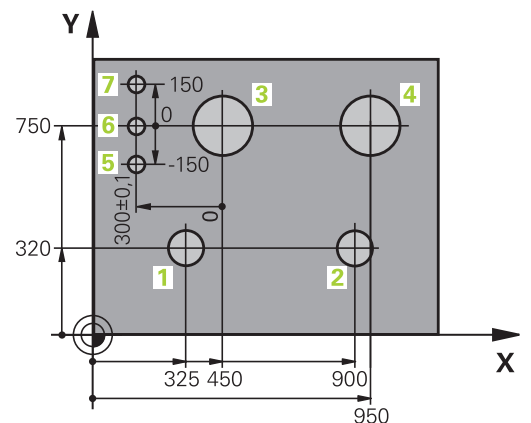
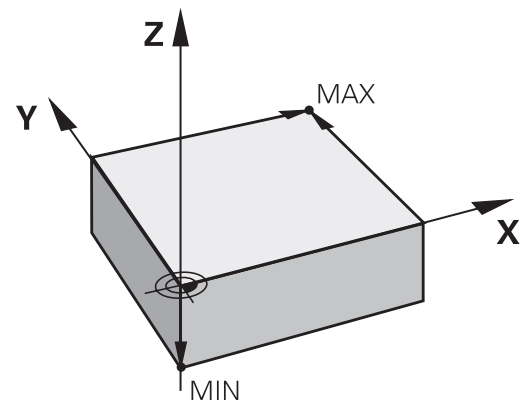

## 4.2 Creating and writing programs

### Structure of an NC program in HEIDENHAIN Klartext

A machining program consists of a series of NC blocks. The illustration on the right shows the elements of a block.

The control numbers the blocks of a part program in ascending order.

The first block of a program is identified by **BEGIN PGM**, the program name and the active unit of measure.

The subsequent blocks contain information on:

- The workpiece blank
- Tool calls
- Approaching a safe position
- Feed rates and spindle speeds, as well as
- Path contours, cycles and other functions

The last block of a program is identified by **END PGM**, the program name and the active unit of measure.

#### Block

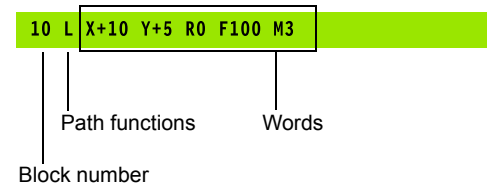

### NOTICE

#### Danger of collision!

The control does not automatically check whether collisions can occur between the tool and the workpiece. There is danger of collision during the approach movement after a tool change!

- ▶ If necessary, program an additional safe auxiliary position



## Defining the blank: BLK FORM

Immediately after initiating a new program, you define an unmachined workpiece blank. If you wish to define the blank at a later stage, press the **SPEC FCT** key, the **PROGRAM DEFAULTS** soft key, and then the **BLK FORM** soft key. The control needs this definition for graphic simulation.



You only need to define the workpiece blank if you wish to run a graphic test for the program!

The control can depict various types of blank forms:

Soft key	Function
	Define a rectangular blank
	Define a cylindrical blank
	Define a rotationally symmetric blank of any shape

### Rectangular blank

The sides of the cuboid lie parallel to the X, Y and Z axes. This blank is defined by two of its corner points:

- MIN point: the smallest X, Y and Z coordinates of the blank form, entered as absolute values.
- MAX point: the largest X, Y and Z coordinates of the blank form, entered as absolute or incremental values

### Example

<b>0 BEGIN PGM NEW MM</b>	Program begin, name, unit of measure
<b>1 BLK FORM 0.1 Z X+0 Y+0 Z-40</b>	Spindle axis, MIN point coordinates
<b>2 BLK FORM 0.2 X+100 Y+100 Z+0</b>	MAX point coordinates
<b>3 END PGM NEW MM</b>	Program end, name, unit of measure

### Cylindrical blank

The cylindrical blank form is defined by the dimensions of the cylinder:

- X, Y or Z: Rotation axis
- D, R: Diameter or radius of the cylinder (with positive algebraic sign)
- L: Length of the cylinder (with positive algebraic sign)
- DIST: Shifting along the rotational axis
- DI, RI: Inside diameter or inside radius for a hollow cylinder



The parameters **DIST** and **RI** or **DI** are optional and need not be programmed.

### Example

<b>0 BEGIN PGM NEW MM</b>	Program begin, name, unit of measure
<b>1 BLK FORM CYLINDER Z R50 L105 DIST+5 RI10</b>	Spindle axis, radius, length, distance, inside radius
<b>2 END PGM NEW MM</b>	Program end, name, unit of measure

### Rotationally symmetric blank of any shape

You define the contour of the rotationally symmetric blank in a subprogram. Use X, Y or Z as the rotation axis.

In the workpiece blank definition you refer to the contour description:

- DIM\_D, DIM-R: Diameter or radius of the rotationally symmetrical blank form
- LBL: Subprogram with the contour description

The contour description may contain negative values in the rotation axis but only positive values in the reference axis. The contour must be closed, i.e. the contour beginning corresponds to the contour end.

If you define a rotationally symmetric blank with incremental coordinates, the dimensions are then independent of the diameter programming.

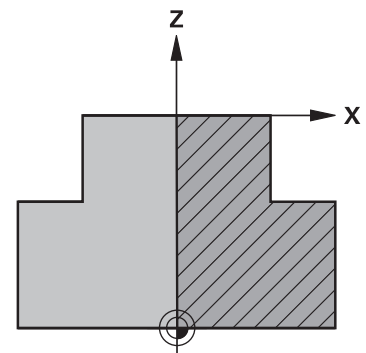

The subprogram can be designated with a number, an alphanumeric name, or a QS parameter.

**Example**

<b>0 BEGIN PGM NEW MM</b>	Program begin, name, unit of measure
<b>1 BLK FORM ROTATION Z DIM_R LBL 1</b>	Spindle axis, manner of interpretation, subprogram number
<b>2 M30</b>	End of main program
<b>3 LBL 1</b>	Beginning of subprogram
<b>4 L X+0 Z+1</b>	Starting point of contour
<b>5 L X+50</b>	Programming in the positive direction of the principal axis
<b>6 L Z-20</b>	
<b>7 L X+70</b>	
<b>8 L Z-100</b>	
<b>9 L X+0</b>	
<b>10 L Z+1</b>	Contour end
<b>11 LBL 0</b>	End of subprogram
<b>12 END PGM NEW MM</b>	Program end, name, unit of measure

## Creating a new NC program

You always enter an NC program in **Programming** mode. An example of program initiation:



- ▶ Operating mode: Press the **Programming** key



- ▶ Press the **PGM MGT** key
- ▶ The control opens the file manager.

Select the directory in which you wish to store the new NC program:

**FILE NAME = NEW.H**



- ▶ Enter the new program name
- ▶ Press the **ENT** key



- ▶ Select the unit of measure: Press the **MM** or **INCH** soft key
- ▶ The control switches the screen layout and initiates the dialog for defining the **BLK FORM** (workpiece blank).



- ▶ Select a rectangular workpiece blank: Press the soft key for a rectangular blank form

### Working plane in graphic: XY



- ▶ Enter the spindle axis, e.g. **Z**

### Workpiece blank def.: Minimum



- ▶ Enter in sequence the X, Y and Z coordinates of the MIN point and confirm each of your entries with the **ENT** key

### Workpiece blank def.: Maximum



- ▶ Enter in sequence the X, Y and Z coordinates of the MAX point and confirm each of your entries with the **ENT** key

### Example

<b>0 BEGIN PGM NEW MM</b>	Program begin, name, unit of measure
<b>1 BLK FORM 0.1 Z X+0 Y+0 Z-40</b>	Spindle axis, MIN point coordinates
<b>2 BLK FORM 0.2 X+100 Y+100 Z+0</b>	MAX point coordinates
<b>3 END PGM NEW MM</b>	Program end, name, unit of measure

The control automatically generates the block numbers as well as the **BEGIN** and **END** blocks.



If you do not wish to define a blank form, cancel the dialog at **Working plane in graphic: XY** using the **DEL** key.

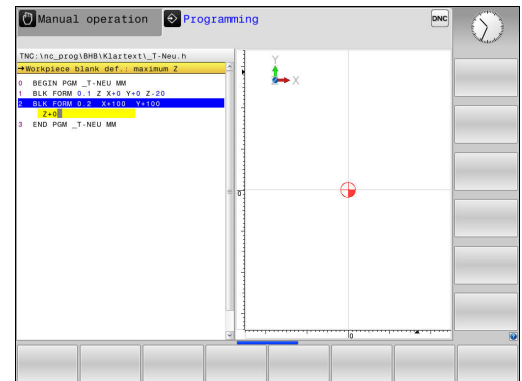

## Programming tool movements in Klartext

To program a block, initiate the dialog by pressing a function key. In the screen headline, the control then asks you for all the information necessary to program the desired function.

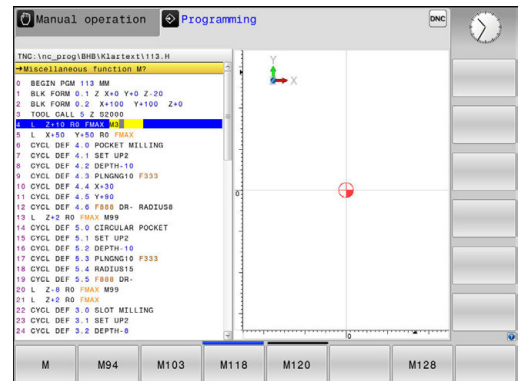

### Example of a positioning block



▶ open the block

### COORDINATES ?



▶ **10** (enter the target coordinate for the X axis)



▶ **20** (enter the target coordinate for the Y axis)



▶ Go to the next question with **ENT**.

### Radius comp.: RL/RR/no comp.?



▶ Enter **No radius compensation** and go to the next question with **ENT**

### Feed rate F=? / F MAX = ENT

▶ **100** (enter a feed rate of 100 mm/min for this path contour)



▶ Go to the next question with **ENT**.

### MISCELLANEOUS FUNCTION M ?

▶ **3** (enter the miscellaneous function **M3 Spindle on**)











▶ With the **END** key, the control ends this dialog.

### Example

**3 L X+10 Y+5 R0 F100 M3**

## Possible feed rate input

Soft key	Functions for setting the feed rate
	Rapid traverse, blockwise. Exception: If defined before an <b>APPR</b> block, <b>FMAX</b> also in effect for moving to an auxiliary point  <b>Further information:</b> "Important positions for approach and departure", page 281
	Traverse feed rate automatically calculated in <b>TOOL CALL</b>
	Move at the programmed feed rate (unit of measure is mm/min or 1/10 inch/min). With rotary axes, the control interprets the feed rate in degrees/min, regardless of whether the program is written in mm or inches
	Define the feed per revolution (units in mm/1 or inch/1). Caution: In inch-programs, FU cannot be combined with M136
	Define the tooth feed (units in mm/tooth or inch/tooth). The number of teeth must be defined in the tool table in the <b>CUT</b> column.
Key	Functions for conversational guidance
	Ignore the dialog question
	End the dialog immediately
	Abort the dialog and erase the block



## Actual position capture

The control enables you to transfer the current tool position into the program, for example during

- Positioning-block programming
- Cycle programming

To transfer the correct position values, proceed as follows:

- ▶ Place the input box at the position in the block where you want to insert a position value



- ▶ Select the actual-position-capture function
- > In the soft-key row the control displays the axes whose positions can be transferred.

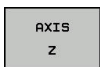

- ▶ Select the axis
- > The control writes the current position of the selected axis into the active input box.



In the working plane the control always captures the coordinates of the tool center, even though tool radius compensation is active.

The control takes the active tool length compensation into account and always captures the coordinate of the tool tip in the tool axis.

The control keeps the soft-key row for axis selection active until the **actual position capture** key is pressed again. This behavior remains in effect even if you save the current block or open a new block with a path function key. If you have to choose an input alternative via soft key (e.g. for radius compensation), then the control closes the soft-key row for axis selection.











The **actual-position-capture** function is not allowed if the **Tilt working plane** function is active.





## Editing an NC program



The active NC program cannot be edited while it is being run.

While you are creating or editing an NC program, you can select any desired line in the NC program or individual words in a block with the arrow keys or the soft keys:

Soft key/key	Function
	Go to previous page
	Go to next page
	Go to beginning of program
	Go to end of program
	Change the position of the current block on the screen. Press this soft key to display additional NC blocks that are programmed before the current block No function if the NC program is fully visible on the screen
	Change the position of the current block on the screen. Press this soft key to display additional NC blocks that are programmed after the current block No function if the NC program is fully visible on the screen
	Move from one block to the next
	
	Select individual words in a block
	
	To select a certain block, press the <b>GOTO</b> key, enter the desired block number, and confirm with the <b>ENT</b> key. Or: Press the <b>GOTO</b> key, enter the block number step and jump up or down the number of entered lines by pressing the <b>N LINES</b> soft key

Soft key/key	Function
	<ul style="list-style-type: none"> <li>■ Set the selected word to zero</li> <li>■ Erase an incorrect number</li> <li>■ Delete the (clearable) error message</li> </ul>
	Delete the selected word
	<ul style="list-style-type: none"> <li>■ Delete the selected block</li> <li>■ Erase cycles and program sections</li> </ul>
	Insert the block that you last edited or deleted

### Inserting blocks at any desired location

- ▶ Select the block after which you want to insert a new block and initiate the dialog

### Saving changes

The control normally saves changes automatically if you switch the operating mode or if you select the file manager. If you deliberately want to save changes to the program, proceed as follows:

- ▶ Select the soft-key row with the saving functions

- |                                                                                     |                                                                                                                                                                              |
|-------------------------------------------------------------------------------------|------------------------------------------------------------------------------------------------------------------------------------------------------------------------------|
|  | <ul style="list-style-type: none"> <li>▶ Press the <b>STORE</b> soft key</li> <li>▶ The control saves all changes made since the last time you saved the program.</li> </ul> |
|-------------------------------------------------------------------------------------|------------------------------------------------------------------------------------------------------------------------------------------------------------------------------|

### Saving a program to a new file

You can save the contents of the currently active program under a different program name. Proceed as follows:

- ▶ Select the soft-key row with the saving functions

- |                                                                                     |                                                                                                                                                                                                                                                                                                                                                                                                                              |
|-------------------------------------------------------------------------------------|------------------------------------------------------------------------------------------------------------------------------------------------------------------------------------------------------------------------------------------------------------------------------------------------------------------------------------------------------------------------------------------------------------------------------|
|  | <ul style="list-style-type: none"> <li>▶ Press the <b>SAVE AS</b> soft key</li> <li>▶ The control opens a window in which you can enter the directory and the new file name.</li> <li>▶ Select the target directory if required with the <b>SWITCH</b> soft key</li> <li>▶ Enter the file name</li> <li>▶ Confirm with the <b>OK</b> soft key or the <b>ENT</b> key, or press the <b>CANCEL</b> soft key to abort</li> </ul> |
|-------------------------------------------------------------------------------------|------------------------------------------------------------------------------------------------------------------------------------------------------------------------------------------------------------------------------------------------------------------------------------------------------------------------------------------------------------------------------------------------------------------------------|



The file saved with **SAVE AS** can also be found in the file management by pressing the **LAST FILES** soft key.

### Undoing changes

You can undo all changes made since the last time you saved the program. Proceed as follows:

- ▶ Select the soft-key row with the saving functions



- ▶ Press the **CANCEL CHANGE** soft key
- ▶ The control opens a window in which you can confirm or cancel this action.
- ▶ Confirm with the **YES** soft key or cancel with the **ENT** key, or press the **NO** soft key to abort

### Editing and inserting words

- ▶ Select a word in a block and overwrite it with the new one. The dialog is available while the word is highlighted
- ▶ To accept the change, press the **END** key

If you want to insert a word, press the horizontal arrow key repeatedly until the desired dialog appears. You can then enter the desired value.

### Looking for the same words in different blocks



- ▶ Select a word in a block: Press the arrow key repeatedly until the desired word is highlighted



- ▶ Select a block with the arrow keys
  - Arrow down: search forwards
  - Arrow up: search backwards

The word that is highlighted in the new block is the same as the one you selected previously.



If you start a search in a very long NC program, the control shows a progress indicator. You can cancel the search at any time, if necessary.

### Marking, copying, cutting and inserting program sections

The control provides the following functions for copying program sections within an NC program or into another NC program:

Soft key	Function
<b>SELECT BLOCK</b>	Switch the marking function on
<b>CANCEL SELECTION</b>	Switch the marking function off
<b>CUT OUT BLOCK</b>	Cut the marked block
<b>INSERT BLOCK</b>	Insert the block that is stored in the buffer memory
<b>COPY BLOCK</b>	Copy the marked block

To copy a program section, proceed as follows:

- ▶ Select the soft key row containing the marking functions
- ▶ Select the first block of the section you wish to copy
- ▶ Mark the first block: Press the **SELECT BLOCK** soft key.
- ▶ The control highlights the block in color and displays the **CANCEL SELECTION** soft key.
- ▶ Move the highlight to the last block of the program section you wish to copy or cut.
- ▶ The control shows the marked blocks in a different color. You can end the marking function at any time by pressing the **CANCEL SELECTION** soft key.
- ▶ Copy the selected program section: Press the **COPY BLOCK** soft key. Cut the selected program section: Press the **CUT OUT BLOCK** soft key.
- ▶ The control stores the selected block.



If you want to transfer a program section to another NC program, you now need to select the desired NC program in the file manager.

- ▶ Using the arrow keys, select the block after which you wish to insert the copied (cut) program section
- ▶ Insert the saved program section: Press the **INSERT BLOCK** soft key
- ▶ To end the marking function, press the **CANCEL SELECTION** soft key

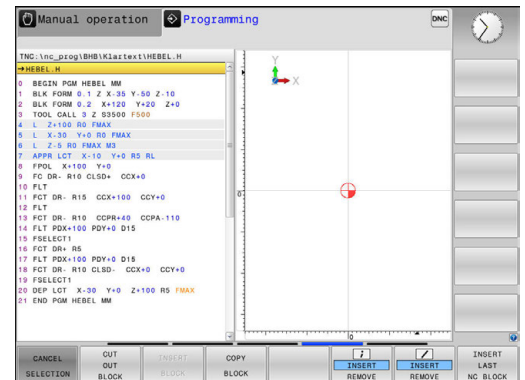

## The control's search function

The search function of the control enables you to search for any text within a program and replace it by a new text, if required.

### Finding any text

FIND

- ▶ Select the search function
- ▶ The control superimposes the search window and displays the available search functions in the soft-key row.
- ▶ Enter the text to be searched for, e.g.: **TOOL**
- ▶ Select forwards search or backwards search
- ▶ Start the search process

FIND

- ▶ The control moves to the next block containing the text you are searching for.

FIND

- ▶ Repeat the search process
- ▶ The control moves to the next block containing the text you are searching for.

END

- ▶ Terminate the search function: Press the END soft key

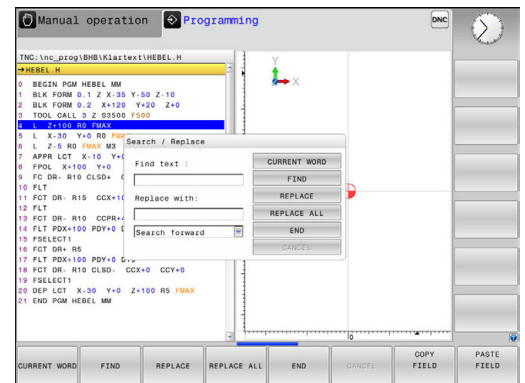

## Finding/Replacing any text

**NOTICE****Caution: Data may be lost!**

The **REPLACE** and **REPLACE ALL** functions overwrite all found syntax elements without a confirmation prompt. The original file is not automatically backed up by the control before the replacement process. As a consequence, NC programs may be irreversibly damaged.

- ▶ Back up the NC programs, if required, before you start the replacement
- ▶ Be careful when using **REPLACE** and **REPLACE ALL**



The **FIND** and **REPLACE** functions cannot be used in the active NC program while the program is being run. The functions are also not available if write protection is active.

- ▶ Select the block containing the word you wish to find

FIND

- ▶ Select the search function
- ▶ The control superimposes the search window and displays the available search functions in the soft-key row.
- ▶ Press the **CURRENT WORD** soft key
- ▶ The control loads the first word of the current block. If required, press the soft key again to load the desired word.

FIND

- ▶ Start the search process
- ▶ The control moves to the next occurrence of the text you are searching for.

REPLACE

- ▶ To replace the text and then move to the next occurrence of the text, press the **REPLACE** soft key. To replace all text occurrences, press the **REPLACE ALL** soft key. To skip the text and move to its next occurrence press the **FIND** soft key

END

- ▶ Terminate the search function: Press the **END** soft key

## 4.3 File management: Basics

### Files

Files in the control	Type
<b>Programs</b>	
in HEIDENHAIN format	.H
in DIN/ISO format	.I
<b>Compatible programs</b>	
HEIDENHAIN unit programs	.HU
HEIDENHAIN contour programs	.HC
<b>Tables for</b>	
Tools	.T
Tool changers	.TCH
Datums	.D
Points	.PNT
Presets	.PR
Touch probes	.TP
Backup files	.BAK
Dependent data (e.g. structure items)	.DEP
Freely definable tables	.TAB
Pallets	.P
<b>Text as</b>	
ASCII files	.A
Log files	.TXT
Help files	.CHM
<b>CAD files as</b>	
ASCII files	.DXF
	.IGES
	.STEP

When you write a part program on the control, you must first enter a program name. The control saves the program to the internal memory as a file with the same name. The control can also save texts and tables as files.

The control provides a special file management window in which you can easily find and manage your files. Here you can call, copy, rename and erase files.

With the control you can manage and save files up to a total size of **2 GB**.



Depending on the setting, the control generates backup files with the extension \*.bak after editing and saving of NC programs. This reduces the available memory space.



### File names

When you store programs, tables and texts as files, the control adds an extension to the file name, separated by a point. This extension indicates the file type.

File name	File type
PROG20	.H

File names, drive names and directory names on the control must comply with the following standard: The Open Group Base Specifications Issue 6 IEEE Std 1003.1, 2004 Edition (POSIX Standard).

The following characters are permitted:

A B C D E F G H I J K L M N O P Q R S T U V W X Y Z a b c d e f g  
h i j k l m n o p q r s t u v w x y z 0 1 2 3 4 5 6 7 8 9 \_ -

The following characters have special meanings:

Character	Meaning
.	The last period (dot) in a file name is the extension separator
\ and /	Directory separators
:	Separates the drive name from the directory

Do not use any other characters. This helps to prevent file transfer problems, etc. Table names must start with a letter.



The maximum permitted path length is 255 characters. The path length consists of the drive characters, the directory name and the file name, including the extension.

**Further information:** "Paths", page 171

## Displaying externally generated files on the control

The control features several additional tools which you can use to display the files shown in the table below. Some of the files can also be edited.

File types	Type
PDF files	pdf
Excel tables	xls csv
Internet files	html
Text files	txt ini
Graphics files	bmp gif jpg png

**Further information:** "Additional tools for management of external file types", page 184

## Data backup

HEIDENHAIN recommends backing up new programs and files created on the control to a PC at regular intervals.

The **TNCremo** data transmission freeware from HEIDENHAIN is a simple and convenient method for backing up data stored on the control.

You can also backup files directly from the control. **Further information:** "Backup and restore", page 112

You additionally need a data medium on which all machine-specific data, such as the PLC program, machine parameters, etc., are stored. Ask your machine manufacturer for assistance, if necessary.



Take the time occasionally to delete any unneeded files so that the control always has enough hard-disk space for system files (such as the tool table).

## 4.4 Working with the file manager

### Directories

To ensure that you can easily find your programs and files, we recommend that you organize your internal memory into directories. You can divide a directory into further directories, which are called subdirectories. With the **-/+** key or **ENT** you can show or hide the subdirectories.

### Paths

A path indicates the drive and all directories and subdirectories under which a file is saved. The individual names are separated by a backslash \.



The maximum permitted path length is 255 characters. The path length consists of the drive characters, the directory name and the file name, including the extension.

### Example







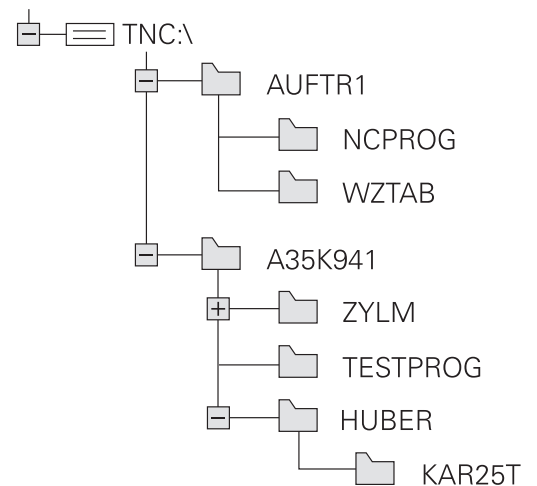











The directory AUFTR1 was created on the **TNC** drive. Then, in the AUFTR1 directory, the directory NCPROG was created and the part program PROG1.H was copied into it. The part program now has the following path:

**TNC:\AUFTR1\NCPROG\PROG1.H**

The chart at right illustrates an example of a directory display with different paths.



## Overview: Functions of the file manager

Soft key	Function	Page
	Copy a single file	176
	Display a specific file type	174
	Create new file	176
	Display the last 10 files that were selected	179
	Delete a file	179
	Tag a file	181
	Rename file	182
	Protect a file against editing and erasure	183
	Cancel file protection	183
	Import tool table of an iTNC 530	243
	Customize table view	523
	Manage network drives	196
	Select the editor	183
	Sort files by properties	182
	Copy a directory	179
	Delete directory with all its subdirectories	
	Refresh directory	
	Rename a directory	
	Create a new directory	

### Calling the file manager



- ▶ Press the **PGM MGT** key
- ▶ The control displays the file management window (see figure for default setting. If the control displays a different screen layout, press the **WINDOW** soft key).

The narrow window on the left shows the available drives and directories. Drives designate devices with which data are stored or transferred. A drive is the internal memory of the control. Other drives are the interfaces (RS232, Ethernet) to which you can connect a PC for example. A directory is always identified by a folder symbol to the left and the directory name to the right. Subdirectories are shown to the right of and below their parent directories. If there are subdirectories, you can show or hide them using the **-/+** key.

If the directory tree is longer than the screen, navigate using the scroll bar or a connected mouse.

The wide window on the right shows you all files that are stored in the selected directory. Each file is shown with additional information, illustrated in the table below.

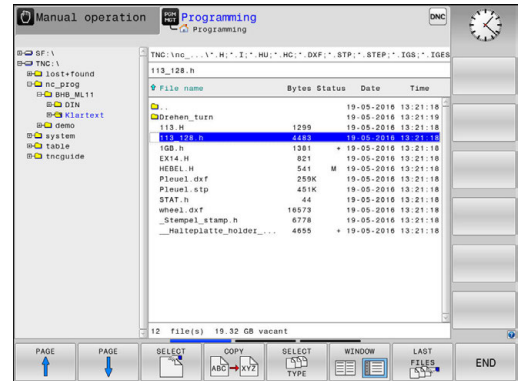

Display	Meaning
<b>File name</b>	File name and file type
<b>Bytes</b>	File size in bytes
<b>Status</b>	File properties:
E	Program is selected in the <b>Programming</b> mode of operation
S	Program is selected in the <b>Test Run</b> mode of operation
M	Program is selected in a Program Run mode of operation
+	Program has non-displayed dependent files with the extension DEP, e.g. with use of the tool usage test
	File is protected against erasing and editing
	File is protected against erasing and editing, because it is being run
<b>Date</b>	Date that the file was last edited
<b>Time</b>	Time that the file was last edited

To display the dependent files, set the machine parameter **dependentFiles** (no. 122101) to **MANUAL**.

## Selecting drives, directories and files



- ▶ To call the file manager, press the **PGM MGT** key.

Navigate with a connected mouse or use the arrow keys or the soft keys to move the cursor to the desired position on the screen:



- ▶ Moves the cursor from the left to the right window, and vice versa



- ▶ Moves the cursor up and down within a window



- ▶ Moves the cursor one page up or down within a window



### Step 1: Select drive

- ▶ Move the highlight to the desired drive in the left window



- ▶ To select a drive, press the **SELECT** soft key, or



- ▶ Press the **ENT** key

**Step 2:** Select a directory

- ▶ Move the highlight to the desired directory in the left-hand window—the right-hand window automatically shows all files stored in the highlighted directory

**Step 3:** Select a file

- ▶ Press the **SELECT TYPE** soft key



- ▶ Press the soft key for the desired file type, or



- ▶ Press the **SHOW ALL** soft key to display all files, or



- ▶ Use wildcards, e.g. **4\*.h**: Show all files of type .h starting with a 4

- ▶ Move the highlight to the desired file in the right window



- ▶ Press the **SELECT** soft key, or



- ▶ Press the **ENT** key
- ▶ The control opens the selected file in the operating mode from which you called the file manager.



If you enter the first letter of the file you are looking for in file management, the cursor automatically jumps to the first program with the same letter.

## Creating a new directory

- ▶ Move the highlight in the left window to the directory in which you want to create a subdirectory



- ▶ Press the **NEW DIRECTORY** soft key
- ▶ Enter a directory name



- ▶ Press the **ENT** key



- ▶ Press the **OK** soft key to confirm or



- ▶ Press the **CANCEL** soft key to abort

## Creating new file

- ▶ Select the directory in the left window in which you wish to create the new file
- ▶ Position the cursor in the right window

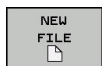

- ▶ Press the **NEW FILE** soft key
- ▶ Enter the file name with extension



- ▶ Press the **ENT** key

## Copying a single file

- ▶ Move the cursor to the file you wish to copy
- ▶ Press the **COPY** soft key to select the copying function
  - > The control opens a pop-up window.

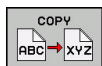

Copying files into the current directory

- ▶ Enter the name of the destination file.
- ▶ Press the **ENT** key or the **OK** soft key
- > The control copies the file to the active directory. The original file is retained.

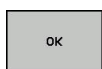

Copying files into another directory

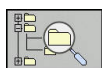

- ▶ Press the **Target Directory** soft key to select the target directory from a pop-up window

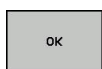

- ▶ Press the **ENT** key or the **OK** soft key
- > The control copies the file under the same name to the selected directory. The original file is retained.



When you start the copying process with the **ENT** key or the **OK** soft key, the control displays a pop-up window with a progress indicator.



## Copying files into another directory

- ▶ Select a screen layout with two equally sized windows

In the right window

- ▶ Press the **SHOW TREE** soft key
- ▶ Move the cursor to the directory into which you wish to copy the files, and display the files in this directory with the **ENT** key

In the left window

- ▶ Press the **SHOW TREE** soft key
- ▶ Select the directory with the files to copy and press the **SHOW FILES** soft key to display them



- ▶ Press the Tag soft key: Call the file tagging functions



- ▶ Press the Tag soft key: Position the cursor on the file you wish to copy and tag. You can tag several files in this way, if desired

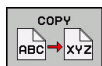

- ▶ Press the Copy soft key: Copy the tagged files into the target directory

**Further information:** "Tagging files", page 181

If you have tagged files in both the left and right windows, the control copies from the directory in which the cursor is located.

## Overwriting files

If you copy files to a directory in which other files are stored under the same name, the control will ask whether the files in the target directory should be overwritten:

- ▶ Overwrite all files (**Existing files** field selected): Press the **OK** soft key, or
- ▶ To leave the files as they are, press the **CANCEL** soft key

If you want to overwrite a protected file, select the **Protected files** field or cancel the process.

## Copying a table

### Importing lines to a table

If you are copying a table into an existing table, you can overwrite individual lines with the **REPLACE FIELDS** soft key. Prerequisites:

- The target table must exist
- The file to be copied must only contain the lines you want to replace
- Both tables must have the same file extension

### NOTICE

#### Caution: Data may be lost!

If you use the **REPLACE FIELDS** function, all lines of the target file that are contained in the copied table will be overwritten without a confirmation prompt. The original file is not automatically backed up by the control before the replacement process. As a consequence, tables may be irreversibly damaged.

- ▶ Back up the tables, if required, before you start the replacement
- ▶ Be careful when using **REPLACE FIELDS**

### Example

With a tool presetter you have measured the length and radius of ten new tools. The tool presetter then generates the TOOL\_Import.T tool table with 10 lines (for the 10 tools).

- ▶ Copy this table from the external data medium to any directory
- ▶ Copy the externally created table to the existing TOOL.T table using the control's file management.
- The control asks you whether you want to overwrite the existing TOOL.T tool table.
- ▶ If you press the **REPLACE FIELDS** soft key, the control will completely overwrite the current TOOL.T tool table. After this copying process the new TOOL.T table consists of 10 lines.
- ▶ Or press the **REPLACE FIELDS** soft key for the control to overwrite the 10 lines in the TOOL.T file. The data of the other lines is not changed.

### Extracting lines from a table



You can select one or more lines in a table and save them in a separate table.

- ▶ Open the table from which you want to copy lines
- ▶ Use the arrow keys to select the first line to be copied
- ▶ Press the **MORE FUNCTIONS** soft key
- ▶ Press the **TAG** soft key
- ▶ Select additional lines, if required
- ▶ Press the **SAVE AS** soft key
- ▶ Enter a name for the table in which the selected lines are to be saved





### Copying a directory

- ▶ Move the highlight in the right window onto the directory you want to copy
- ▶ Press the **COPY** soft key
- ▶ The control opens the window for selecting the target directory.
- ▶ Select the target directory and confirm with the **ENT** key or the **OK** soft key
- ▶ The control copies the selected directory and all its subdirectories to the selected target directory.

### Choosing one of the last files selected

-  ▶ To call the file manager, press the **PGM MGT** key.
-  ▶ To display the last ten files selected: press the **LAST FILES** soft key

Press the arrow keys to move the cursor to the file you wish to select:

-  ▶ Moves the cursor up and down within a window
-  ▶ Moves the cursor up and down within a window
-  ▶ To select the file, press the **OK** soft key, or
-  ▶ Press the **ENT** key

 The **COPY FIELD** soft key allows you to copy the path of a marked file. You can reuse the copied path later, e.g. when calling a program with the **PGM CALL** key.

### Deleting a file

**NOTICE**

**Caution: Data may be lost!**

The **DELETE** function permanently deletes the file. The file is not automatically backed up by the control, e.g. to a recycle bin, before being deleted. Files are irreversibly deleted by this function.

- ▶ Regularly back up important data to external drives

- ▶ Move the cursor to the file you want to delete
-  ▶ To select the erasing function, press the **DELETE** soft key
- ▶ The control asks whether you want to delete the file.
- ▶ To confirm the deletion, press the **OK** soft key; or
- ▶ To cancel deletion, press the **CANCEL** soft key

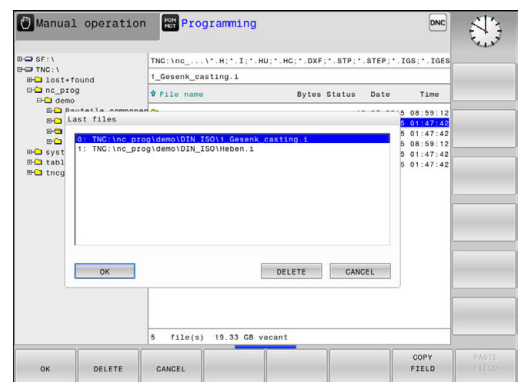

## Deleting a directory

### NOTICE

#### Caution: Data may be lost!

The **DELETE ALL** function permanently deletes all files of the directory. The files are not automatically backed up by the control, e.g. to a recycle bin, before being deleted. Files are irreversibly deleted by this function.





- ▶ Regularly back up important data to external drives

- ▶ Move the cursor to the directory you want to delete



- ▶ To select the erasing function, press the **DELETE** soft key
- ▶ The control asks you whether you really want to delete the directory and all its subdirectories and files.
- ▶ To confirm the deletion, press the **OK** soft key; or
- ▶ To cancel deletion, press the **CANCEL** soft key

## Tagging files

Soft key	Tagging function
	Tag a single file
	Tag all files in the directory
	Untag a single file
	Untag all files
	Copy all tagged files

Some functions, such as copying or erasing files, can not only be used for individual files, but also for several files at once. To tag several files, proceed as follows:

- ▶ Move the cursor to the first file

- ▶ To display the tagging functions, press the **TAG** soft key
- ▶ To tag the file, press the **TAG FILE** soft key
- ▶ Move the cursor to other files
- ▶ To select the next file, press the **TAG FILE** soft key. Repeat this process for all files you want to tag.

To copy tagged files:

- ▶ Leave the active soft-key row
- ▶ Press the **COPY** soft key

To delete tagged files:

- ▶ Leave the active soft-key row
- ▶ Press the **DELETE** soft key

## Renaming a file

- ▶ Move the cursor to the file you wish to rename

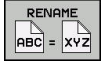

- ▶ To select the function for renaming, press the **RENAME** soft key
- ▶ Enter the new file name; the file type cannot be changed
- ▶ To rename: Press the **OK** soft key or the **ENT** key

## Sorting files

- ▶ Select the folder in which you wish to sort the files



- ▶ Press the **SORT** soft key
- ▶ Select the soft key with the corresponding display criterion
  - **SORT BY NAME**
  - **SORT BY SIZE**
  - **SORT BY DATE**
  - **SORT BY TYPE**
  - **SORT BY STATUS**
  - **UNSORTED**

## Additional functions

### Protecting a file / Canceling file protection

- ▶ Move the cursor to the file you want to protect



- ▶ To select the additional functions, press the **MORE FUNCTIONS** soft key



- ▶ Enable file protection: Press the **PROTECT** soft key. The file is tagged with the "protected" symbol



- ▶ To cancel file protection, press the **UNPROTECT** soft key

### Selecting the editor

- ▶ Move the cursor in the right-hand window onto the file you want to open

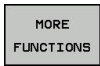

- ▶ To select the additional functions, press the **MORE FUNCTIONS** soft key



- ▶ To select the editor with which to open the selected file, press the **SELECT EDITOR** soft key
- ▶ Mark the desired editor
- ▶ Press the **OK** soft key to open the file

### Connecting and removing USB storage devices

The control automatically detects connected USB devices with a supported file system.

- ▶ To remove a USB device, proceed as follows:

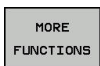

- ▶ Move the cursor to the left-hand window
- ▶ Press the **MORE FUNCTIONS** soft key



- ▶ Remove the USB device

**Further information:** "USB devices on the control", page 197

## Additional tools for management of external file types

The additional tools enable you to display or edit various externally created file types on the control.

File types	Description
PDF files (pdf)	page 185
Excel spreadsheets (xls, csv)	page 186
Internet files (htm, html)	page 187
ZIP archives (zip)	page 189
Text files (ASCII files, e.g. txt, ini)	page 190
Video files (ogg, oga, ogv, ogx)	page 191
Graphics files (bmp, jpg, gif, png)	page 191



Files with the extensions pdf, xls, zip, bmp, gif, jpg and png must be transmitted in binary format from the PC to the control. Adjust the setting in the TNCremo data transfer software, if required (menu item >**Extras** > **Configuration** > **Mode**).



If you are using a TNC 620 with touch control, you can replace some keystrokes with hand-to-screen contact.  
**Further information:** "Operating the Touchscreen", page 123



## Displaying PDF files

To open PDF files directly on the control, proceed as follows:

PGM  
MGT

- ▶ To call the file manager, press the **PGM MGT** key.
- ▶ Select the directory in which the PDF file is saved
- ▶ Move the cursor to the PDF file
- ▶ Press the **ENT** key
- ▶ The control opens the PDF file in its own application using the **PDF viewer** additional tool.

ENT



With the key combination ALT+TAB you can always return to the control's user interface while leaving the PDF file open. Alternatively, you can also click the corresponding symbol in the task bar to switch back to the user interface of the control.



If you position the mouse pointer over a button, a brief tool tip explaining the function of this button will be displayed. More information on how to use the **PDF viewer** is provided under **Help**.

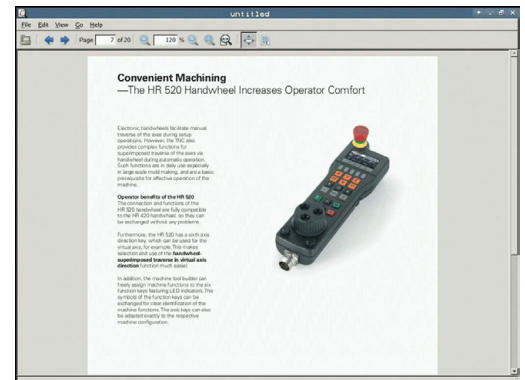

Proceed as follows to exit the **PDF viewer**:

- ▶ Use the mouse to select the **File** menu item
- ▶ Select **Close**
- ▶ The control returns to the file management.

If you are not using a mouse, proceed as follows to close the **PDF viewer**:



- ▶ Press the key for switching the soft keys
- ▶ The **PDF viewer** opens the **File** pull-down menu.



- ▶ Move the cursor to the **Close** menu item.

ENT

- ▶ Press the **ENT** key
- ▶ The control returns to the file management.

### Displaying and editing Excel files

Proceed as follows to open and edit Excel files with the extension **xls**, **xlsx** or **csv** directly on the control:



- ▶ To call the file manager, press the **PGM MGT** key.
- ▶ Select the directory in which the Excel file is saved
- ▶ Move the cursor to the Excel file



- ▶ Press the **ENT** key
- ▶ The control opens the Excel file in its own application using the **Gnumeric** additional tool.



With the key combination ALT+TAB you can always return to the control's user interface while leaving the Excel file open. Alternatively, you can also click the corresponding symbol in the task bar to switch back to the user interface of the control.



If you position the mouse pointer over a button, a brief tool tip explaining the function of this button will be displayed. More information on how to use the **Gnumeric** function is provided under **Help**.

Proceed as follows to exit **Gnumeric**:

- ▶ Use the mouse to select the **File** menu item
- ▶ Select **Close**
- ▶ The control returns to the file management.

If you are not using a mouse, proceed as follows to close the additional **Gnumeric** tool:



- ▶ Press the key for switching the soft keys
- ▶ The **Gnumeric** additional tool opens the **File** pull-down menu.



- ▶ Move the cursor to the **Close** menu item



- ▶ Press the **ENT** key
- ▶ The control returns to the file management.

## Displaying Internet files



Configure and use the sandbox on your control. For safety and security reasons, always open the browser in the sandbox.

Proceed as follows to open Internet files with the extension **htm** or **html** directly on the control:

PGM  
MGT

- ▶ To call the file manager, press the **PGM MGT** key.
- ▶ Select the directory in which the Internet file is saved
- ▶ Move the cursor to the Internet file
- ▶ Press the **ENT** key
- ▶ The control opens the Internet file in its own application using the **Web Browser** additional tool.

ENT



With the key combination ALT+TAB you can always return to the control's user interface while leaving the PDF file open. Alternatively, you can also click the corresponding symbol in the task bar to switch back to the user interface of the control.



If you position the mouse pointer over a button, a brief tool tip explaining the function of this button will be displayed. More information on how to use **Web Browser** is available in **Help**.

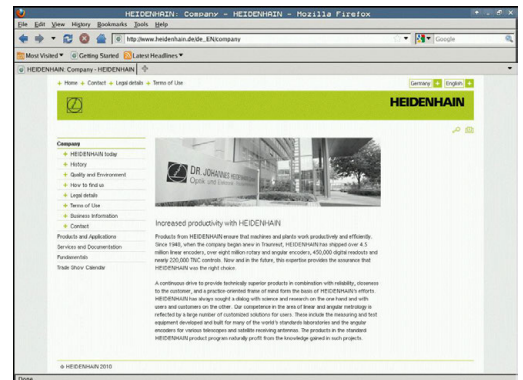

Proceed as follows to exit the **Web Browser**:

- ▶ Use the mouse to select the **File** menu item
- ▶ Select **Quit**
- > The control returns to the file management.

If you are not using a mouse, proceed as follows to close the **Web Browser**:



- ▶ Press the key for switching the soft keys: The **Web Browser** opens the **File** pull-down menu



- ▶ Move the cursor to the **Quit** menu item



- ▶ Press the **ENT** key
- > The control returns to the file management.



Do not change the Web Browser version.  
Otherwise, the security settings of SELinux will block the execution of Web Browser.

## Working with ZIP archives

Proceed as follows to open ZIP archives with the extension **zip** directly on the control:

PGM  
MGT

- ▶ To call the file manager, press the **PGM MGT** key.
- ▶ Select the directory in which the archive file is saved
- ▶ Move the cursor to the archive file
- ▶ Press the **ENT** key
- ▶ The control opens the archive file in its own application using the **Xarchiver** additional tool.

ENT

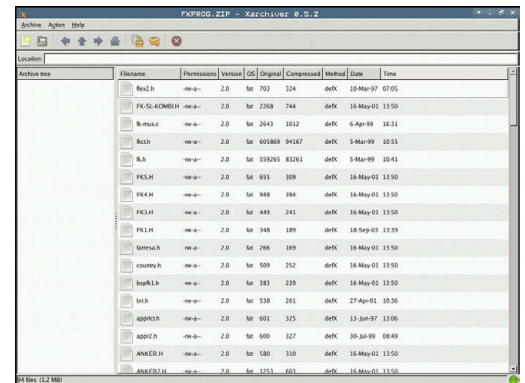

With the key combination ALT+TAB you can always return to the control's user interface while leaving the archive file open. Alternatively, you can also click the corresponding symbol in the task bar to switch back to the user interface of the control.



If you position the mouse pointer over a button, a brief tool tip explaining the function of this button will be displayed. More information on how to use the **Xarchiver** function is provided under **Help**.

Proceed as follows to exit **Xarchiver**:

- ▶ Use the mouse to select the **ARCHIVE** menu item
- ▶ Select **Exit**
- ▶ The control returns to the file management.

If you are not using a mouse, proceed as follows to close the **Xarchiver**:



- ▶ Press the key for switching the soft keys
- ▶ **Xarchiver** opens the **ARCHIVE** pull-down menu.



- ▶ Move the cursor to the **Exit** menu item

ENT

- ▶ Press the **ENT** key
- ▶ The control returns to the file management.

## Displaying and editing text files

Use the internal text editor to open and edit text files (ASCII files, e.g. with the extension **txt**). Proceed as follows:

PGM  
MGT

- ▶ To call the file manager, press the **PGM MGT** key.
- ▶ Select the drive and the directory in which the text file is saved
- ▶ Move the cursor to the text file
- ▶ Press the **ENT** key
- ▶ The control opens the text file with the internal text editor.

ENT



Alternatively, you can also open the ASCII files using the **Leafpad** additional tool. The shortcuts you are familiar with from Windows, which you can use to edit texts quickly (CTRL+C, CTRL+V,...), are available within **Leafpad**.



With the key combination ALT+TAB you can always return to the control's user interface while leaving the text file open. Alternatively, you can also click the corresponding symbol in the task bar to switch back to the user interface of the control.

Proceed as follows to open **Leafpad**:

- ▶ Use the mouse to select the **Menu HEIDENHAIN** icon from the task bar
- ▶ Select the **Tools** and **Leafpad** menu items in the pull-down menu

Proceed as follows to exit **Leafpad**:

- ▶ Use the mouse to select the **File** menu item
- ▶ Select **Exit**
- ▶ The control returns to the file management.

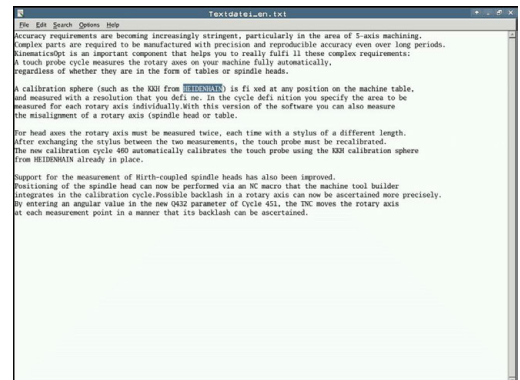

### Displaying video files



This feature must be enabled and adapted by the machine tool builder.

Proceed as follows to open video files with the extension **ogg**, **oga**, **ogv** or **ogx** directly on the control:

PGM  
MGT

- ▶ To call the file manager, press the **PGM MGT** key.
- ▶ Select the directory in which the video file is saved
- ▶ Move the cursor to the video file

ENT

- ▶ Press the **ENT** key
- ▶ The control opens the video file in its own application.

### Displaying graphic files

Proceed as follows to open graphics files with the extension **bmp**, **gif**, **jpg** or **png** directly on the control:

PGM  
MGT

- ▶ To call the file manager, press the **PGM MGT** key.
- ▶ Select the directory in which the graphics file is saved
- ▶ Move the cursor to the graphics file

ENT

- ▶ Press the **ENT** key
- ▶ The control opens the graphics file in its own application using the **ristretto** additional tool.



With the key combination ALT+TAB you can always return to the control's user interface while leaving the graphics file open. Alternatively, you can also click the corresponding symbol in the task bar to switch back to the user interface of the control.



More information on how to use the **ristretto** function is provided under **Help**.

Proceed as follows to exit **ristretto**:

- ▶ Use the mouse to select the **File** menu item
- ▶ Select **Exit**
- ▶ The control returns to the file management.

If you are not using a mouse, proceed as follows to close the additional **ristretto** tool:



- ▶ Press the key for switching the soft keys
- ▶ **ristretto** opens the **File** pull-down menu.



- ▶ Move the cursor to the **Exit** menu item

ENT

- ▶ Press the **ENT** key
- ▶ The control returns to the file management.



## Additional tools for ITCs

The following additional tools allow you to apply various settings for the touch screens on connected ITCs.

ITCs are industrial PCs without their own memory media, and therefore they do not have their own operating system. This feature is what makes ITCs different from IPCs.

ITCs are frequently used with large machinery, e.g. as a clone of the actual control system.



Refer to your machine manual.

The machine manufacturer defines and configures the display and function of the connected ITCs and IPCs.

Additional tool	Application
ITC Calibration	4-point calibration
ITC Gestures	Configuration of gesture control
ITC touchscreen configuration	Selection of touch sensitivity



The additional tools for the ITCs are only provided by the control in the taskbar with connected ITCs.

### ITC Calibration

Using the additional tool **ITC Calibration**, you align the position for the mouse cursor displayed with the actual movement position of your finger.

Calibration using the additional **ITC Calibration** tool is recommended in the following cases:

- After replacing the touchscreen
- When changing the touch screen position (parallel axis error due to amended viewing angle)

Calibration involves the following steps:

- ▶ Start the tool in control using the task bar
- > The ITC opens the calibration screen with four touch points in the corners of the screen
- ▶ Touch the four touch points shown one after the other
- > The ITC closes the calibration screen once calibration has been successfully completed

### ITC Gestures

Using the additional **ITC Gestures** tool, the machine manufacturer configures the gesture control on the touch screen.



Refer to your machine manual.

This function may only be used with the permission of your machine manufacturer.



### ITC touchscreen configuration

Using the additional **ITC Touchscreen Configuration** tool, you can select the touch sensitivity of the touch screen.

The ITC gives you the following options:

- **Normal Sensitivity (Cfg 0)**
- **High Sensitivity (Cfg 1)**
- **Low Sensitivity (Cfg 2)**

Use the **Normal Sensitivity (Cfg 0)** setting as standard. If you find it difficult to operate the equipment while wearing gloves in this setting, select the **High Sensitivity (Cfg 1)** setting.



If the ITC touch screen is not splash-proof, select the **Low Sensitivity (Cfg 2)** setting. This stops the ITC interpreting drops of water as touches.

Configuration involves the following steps:

- ▶ Start the tool in control using the task bar
- > The ITC opens a pop-up window with three options
- ▶ Select Touch Sensitivity
- ▶ Press the **OK** button
- > The ITC closes the pop-up window

## Data transfer to or from an external data carrier



Before you can transfer data to an external data medium, you must set up the data interface.

**Further information:** "Setting up data interfaces", page 751

PGM  
MGT

- ▶ To call the file manager, press the **PGM MGT** key.



- ▶ Select the screen layout for data transfer: press the **WINDOW** soft key.

Use the arrow keys to move the cursor to the file you wish to transfer:



- ▶ Moves the cursor up and down within a window



- ▶ Moves the cursor from the right to the left window, and vice versa

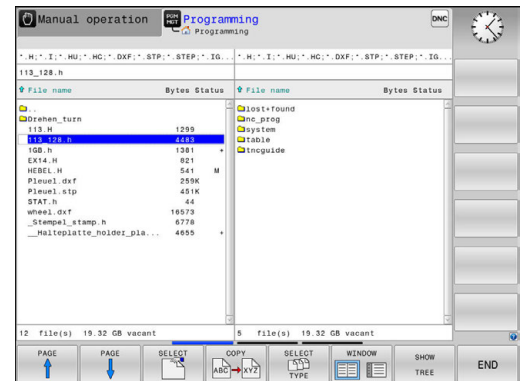

If you wish to copy from the control to the external data medium, move the cursor in the left window to the file to be transferred.

If you wish to copy from the external data medium to the control, move the cursor in the right window to the file to be transferred.



- ▶ Select another drive or directory: Press the **SHOW TREE** soft key
- ▶ Use the arrow keys to select the desired directory



- ▶ Select the desired file: Press the **SHOW FILES** soft key

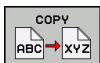

- ▶ Use the arrow keys to select the file
- ▶ Transfer a single file: Press the **COPY** soft key

- ▶ Confirm with the **OK** soft key or with the **ENT** key
- > A status window appears on the control, informing about the copying progress, or



- ▶ Stop transfer: Press the **WINDOW** soft key
- > The control displays the standard file manager window again.

## The control in a network



Protect your data and your control by running your machines in a secure network.



Use the Ethernet card to connect the control to the network.

**Further information:** "Ethernet interface ", page 757

The control logs any error messages that occur during network operation.

If the control is connected to a network, the left directory window displays additional drives. All the functions described above (selecting a drive, copying files, etc.) also apply to network drives, provided that you have been granted the corresponding rights.

### Connecting and disconnecting a network drive

PGM  
MGT

- ▶ To call the file manager, press the **PGM MGT** key

NET

- ▶ Select network settings: Press the **NET** soft key (soft-key row 2)
- ▶ To manage the network drives: Press the **DEFINE NETWORK CONNECTN.** soft key.
- ▶ In a window the control shows the network drives available for access.
- ▶ With the soft keys described below you can define the connection for each drive.

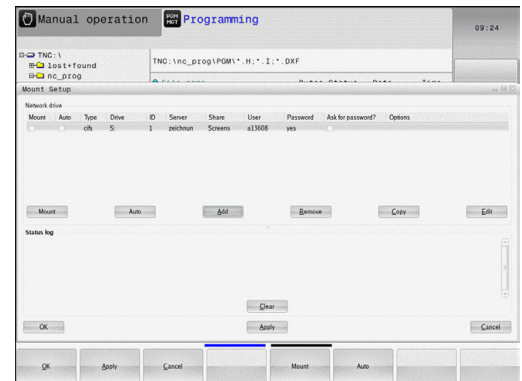

Soft key	Function
<b>Connect</b>	Establish the network connection. If the connection is active, the control marks the <b>Mount</b> column.
<b>Separate</b>	End network connection
<b>Auto</b>	Automatically establish network connection whenever the control is switched on. The control marks the <b>Auto</b> column if the connection is established automatically
<b>Add</b>	Set up new network connection
<b>Remove</b>	Delete existing network connection
<b>Copy</b>	Copy network connection
<b>Edit</b>	Edit network connection
<b>Clear</b>	Delete the status window

## USB devices on the control



Use the USB port only for file transfer and backup. Before editing or running an NC program, save it to the hard disk of the control. This helps to avoid duplicate data maintenance and prevents potential problems resulting from data transfer during program run.

Backing up data from or loading onto the control is especially easy with USB devices. The control supports the following USB block devices:

- Floppy disk drives with FAT/VFAT file system
- Memory sticks with the FAT/VFAT file system
- Hard disks with the FAT/VFAT file system
- CD-ROM drives with the Joliet (ISO 9660) file system

The control automatically detects these types of USB devices when connected. The control does not support USB devices with other file systems (such as NTFS). The control displays the **USB: TNC does not support device** error message when such a device is connected.



If an error message is displayed when connecting a USB data medium, check the setting in the SELinux security software.

**Further information:** "SELinux security software", page 109

If the control displays the **USB: TNC does not support device** error message when using a USB hub, ignore and acknowledge the message with the **CE** key.

If the control repeatedly fails to correctly detect a USB device with the FAT/VFAT file system, connect another device to check the port. If this resolves the problem, use the properly working device.

## Working with USB devices



Refer to your machine manual.

Your machine tool builder can assign permanent names for USB devices.

The USB devices appear as separate drives in the directory tree, so you can use the file management functions described in the earlier chapters.

If a larger file is transferred to a USB device in the file management, the control displays a dialog **Write access on USB device** until file transfer is completed. The dialog is closed with the **HIDE** soft key and file transfer is continued in the background. The control displays a warning until file transfer is completed.

### Removing USB devices

- ▶ To remove a USB device, proceed as follows:



- ▶ Move the cursor to the left-hand window
- ▶ Press the **MORE FUNCTIONS** soft key



- ▶ Remove the USB device

# 5

## Programming Aids

## 5.1 Screen keypad

If you are using the compact version of the control (without alphabetic keyboard), you can enter letters and special characters with the screen keypad or with a PC keyboard connected to the USB port.

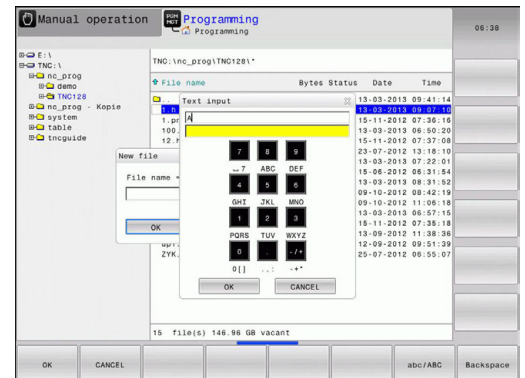

### Entering text with the screen keypad

- ▶ Press the **GOTO** key if you want to enter letters, e.g. a program name or directory name, using the screen keypad.
- ▶ The control opens a window in which the numeric entry field of the control is displayed with the corresponding letters assigned.
- ▶ You can move the cursor to the desired character by repeatedly pressing the respective key
- ▶ Wait until the control transfers the selected character to the entry field before you enter the next character
- ▶ Use the **OK** soft key to load the text into the open dialog field

Use the **abc/ABC** soft key to select upper or lower case. If your machine manufacturer has defined additional special characters, you can call them with the **SPECIAL CHARACTERS** soft key and insert them. Use the **BACKSPACE** soft key to delete individual characters.



## 5.2 Adding comments

### Application

You can add comments to an NC program to explain program steps or make general notes.

**i** The control shows long comments in different ways, depending on the machine parameter **lineBreak** (no. 105404). It either wraps the comment lines or displays the **>>** symbol to indicate additional content. The last character in a comment block must not have any tilde(~).

You can add comments in different ways.

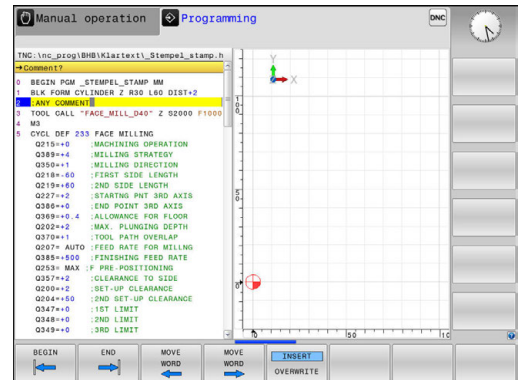

### Entering comments during programming

- ▶ Enter the data for an NC block
- ▶ Press the semicolon key ; on the alphabetic keyboard
- ▶ The control displays the dialog prompt **Comment?**
- ▶ Enter the comment
- ▶ Press the **END** key to conclude the NC block

### Inserting comments after program entry

- ▶ Select the NC block to which you want to add the comment
- ▶ Select the last word in the NC block with the right arrow key:
- ▶ Press the semicolon key ; on the alphabetic keyboard
- ▶ The control displays the dialog prompt **Comment?**
- ▶ Enter the comment
- ▶ Press the **END** key to conclude the NC block

### Entering a comment in a separate block

- ▶ Select the NC block after which you want to insert the comment
- ▶ Initiate the programming dialog with the semicolon key ; on the alphabetic keyboard
- ▶ Enter your comment and conclude the NC block by pressing the **END** key

### Commenting out an existing NC block

Proceed as follows to change an existing NC block to a comment:

- ▶ Select the NC block to be commented out
- ▶ Press the **INSERT COMMENT** soft key



Alternative:

- ▶ Press the < key on the alphabetic keyboard
- ▶ The control inserts a semicolon ; at the beginning of the block.
- ▶ Press the **END** key

### Changing a comment for an NC block

Proceed as follows to change a commented-out NC block to an active NC block:

- ▶ Select the comment block you want to change







- ▶ Press the **REMOVE COMMENT** soft key

Alternative:

- ▶ Press the > key on the alphabetic keyboard
- ▶ The control removes the semicolon ; at the beginning of the block.
- ▶ Press the **END** key

### Functions for editing of the comment

Soft key	Function
	Jump to beginning of comment
	Jump to end of comment
	Jump to the beginning of a word. Use a space to separate words
	Jump to the end of a word. Use a space to separate words
	Switch between paste and overwrite mode

### 5.3 Freely editing an NC program

Certain syntax elements, such as LN blocks, cannot be entered directly in the NC editor by using the available keys and soft keys.

To prevent the use of an external text editor, the control offers the following possibilities:

- Free syntax input using the control's integrated text editor
- Free syntax input using the **?** key in the NC editor

#### Free syntax input using the control's integrated text editor

Proceed as follows to add syntax to an existing NC program:

- |                   |                                            |
|-------------------|--------------------------------------------|
| PGM<br>MGT        | ▶ Press the <b>PGM MGT</b> key             |
|                   | > The control opens the file manager.      |
| MORE<br>FUNCTIONS | ▶ Press the <b>MORE FUNCTIONS</b> soft key |
| SELECT<br>EDITOR  | ▶ Press the <b>SELECT EDITOR</b> soft key  |
|                   | > The control opens a selection window.    |
| OK                | ▶ Select the <b>TEXT EDITOR</b> option     |
|                   | ▶ Confirm your selection with <b>OK</b>    |
|                   | ▶ Add the desired syntax                   |

**i** The control does not check the syntax in the text editor. Check your entries in the NC editor when you are finished.

#### Free syntax input using the **?** key in the NC editor

**i** To use this function you will need a keyboard connected via USB.

Proceed as follows to add syntax to an existing, open NC program:

- |          |                                      |
|----------|--------------------------------------|
| ↑        | ▶ Enter <b>?</b>                     |
|          | > The control opens a new NC block.  |
| ?        |                                      |
| END<br>□ | ▶ Add the desired syntax             |
|          | ▶ Confirm your entry with <b>END</b> |

**i** After confirmation, the control checks the syntax. Errors will result in **ERROR** blocks.

## 5.4 Display of NC programs

### Syntax highlighting

The control displays syntax elements with various colors according to their meaning. Programs are made more legible and clear with color-highlighting.

#### Color highlighting of syntax elements

Use	Color
Standard color	Black
Display of comments	Green
Display of numerical values	Blue
Display of the block number	Violet
Display of FMAX	Orange
Display of the feed rate	Brown

### Scrollbar

Screen content can be shifted with the mouse using the scrollbar at the right edge of the program window. In addition, the size and position of the scrollbar indicates program length and cursor position.

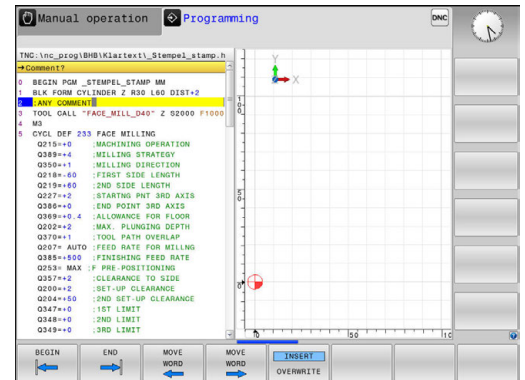

## 5.5 Structuring programs

### Definition and applications

The control offers you the possibility to comment part programs in structuring blocks. Structuring blocks are texts with up to 252 characters and are used as comments or headlines for the subsequent program lines.

With the aid of appropriate structuring blocks, you can organize long and complex programs in a clear and comprehensible manner.

This function is particularly convenient if you want to change the program later. Structuring blocks can be inserted into the part program at any point.

Structure blocks can also be displayed in a separate window, and be edited or added to, as desired. Use the appropriate screen layout for this.

The control manages the inserted structure items in a separate file (extension: .SEC.DEP). This speeds navigation in the program structure window.

The **PROGRAM + SECTS** screen layout can be selected in the following operating modes:

- Program run, single block
- Program run, full sequence
- Programming

### Displaying the program structure window / Changing the active window

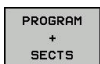

- ▶ Display structure window: For this screen layout press the **PROGRAM + STRUCTURE** soft key



- ▶ Change the active window: Press the **CHANGE WINDOW** soft key

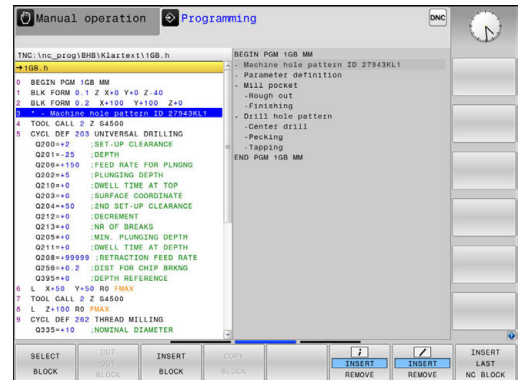

## Inserting a structure block in the program window

- ▶ Select the block after which the structuring block is to be inserted



- ▶ Press the **SPEC FCT** key



- ▶ Press the **PROGRAMMING AIDS** soft key



- ▶ Press the **INSERT SECTION** soft key
- ▶ Enter the structuring text



- ▶ If necessary, change the structure depth with the soft key



You can also insert structure blocks with the key combination **Shift + 8**.

## Selecting blocks in the program structure window

If you are scrolling through the program structure window block by block, the control at the same time automatically moves the corresponding NC blocks in the program window. This way you can quickly skip large program sections.

## 5.6 Calculator

### Operation

The control features an integrated calculator with the basic mathematical functions.

- ▶ Use the **CALC** key to show and hide the calculator
- ▶ Select the arithmetical functions: The calculator is operated with short commands via soft key or through the alphabetic keyboard

Calculate function	Shortcut (soft key)
Addition	+
Subtraction	-
Multiplication	*
Division	/
Calculating with parentheses	( )
Arc cosine	ARC
Sine	SIN
Cosine	COS
Tangent	TAN
Powers of values	X^Y
Square root	SQRT
Inversion	1/x
pi (3.14159265359)	PI
Add value to buffer memory	M+
Save the value to buffer memory	MS
Recall from buffer memory	MR
Delete buffer memory contents	MC
Natural logarithm	LN
Logarithm	LOG
Exponential function	e^x
Check the algebraic sign	SGN
Form the absolute value	ABS

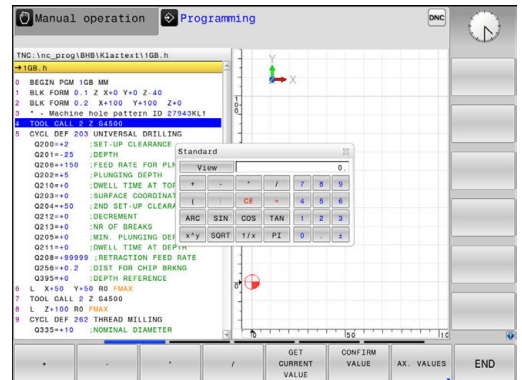

Calculate function	Shortcut (soft key)
Truncate decimal places	INT
Truncate places before the decimal point	FRAC
Modulus operator	MOD
Select view	View
Delete value	CE
Unit of measure	MM or INCH
Show angle values in radians (standard: angle in degrees)	RAD
Select the display mode of the numerical value	DEC (decimal) or HEX (hexadecimal)

#### Transferring the calculated value into the program

- ▶ Use the arrow keys to select the word into which the calculated value is to be transferred
- ▶ Superimpose the on-line calculator by pressing the **CALC** key and perform the desired calculation
- ▶ Press the **CONFIRM VALUE** soft key
- > The control transfers the value into the active input field and closes the calculator.



You can also transfer values from an NC program into the calculator. When you press the **GET CURRENT VALUE** soft key or the **GOTO** key, the control transfers the value from the active input field to the calculator.

The calculator remains in effect even after a change in operating modes. Press the **END** soft key to close the calculator.



### Functions in the pocket calculator

Soft key	Function
AX . VALUES	Load the nominal or reference value of the respective axis position into the calculator
GET CURRENT VALUE	Load the numerical value from the active input field into the calculator
CONFIRM VALUE	Load the numerical value from the calculator field into the active input field
COPY FIELD	Copy the numerical value from the calculator
PASTE FIELD	Insert the copied numerical value into the calculator
CUTTING DATA CALCULATOR	Open the cutting data calculator



You can also shift the calculator with the arrow keys on your keyboard. If you have connected a mouse you can also position the calculator with this.

## 5.7 Cutting data calculator

### Application

With the cutting data calculator you can calculate the spindle speed and the feed rate for a machining process. Then you can load the calculated values into an opened feed rate or spindle speed dialog box in the NC program.

To open the cutting data calculator, press the **CUTTING DATA CALCULATOR** soft key. The control shows the soft key if you

- open the on-line calculator (press the **CALC** soft key)
- open the dialog field for spindle speed input in the **TOOL CALL** block
- open the dialog field for feed rate input in positioning blocks or cycles
- enter a feed rate in manual mode (press the **F** soft key)
- enter a spindle speed in manual mode (press the **S** soft key)

The cutting data calculator is displayed with different input fields depending on whether you calculate a spindle speed or a feed rate:

#### Window for spindle speed calculation:

Code letter	Meaning
R:	Tool radius (mm)
VC:	Cutting speed (m/min)
S=	Result for spindle speed (rev/min)

#### Window for feed rate calculation:







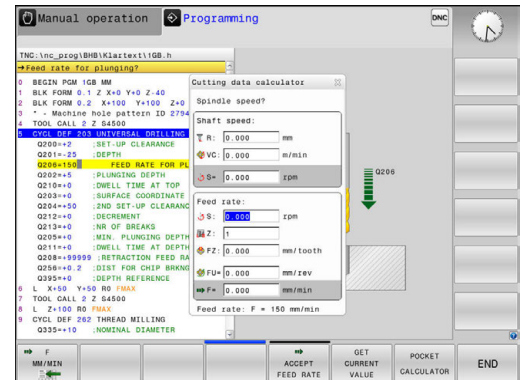







Code letter	Meaning
S:	Spindle speed (rpm)
Z:	Number of teeth on the tool (n)
FZ:	Feed per tooth (mm/tooth)
FU:	Feed rate per revolution (mm/1)
F=	Result for feed rate (mm/min)



You can transfer the feed rate from the **TOOL CALL** block into subsequent traversing blocks and cycles by pressing the **F AUTO** soft key. If you have to change the feed rate later, you only need to adjust the feed rate value in the **TOOL CALL** block.



**Functions in the cutting data calculator:**

Soft key	Function
	Load the spindle speed from the cutting data calculator form into an open dialog field.
	Load the feed rate from the cutting data calculator form into an open dialog field.
	Load the cutting speed from the cutting data calculator form into an open dialog field.
	Load the feed per tooth from the cutting data calculator form into an open dialog field.
	Load the feed per revolution from the cutting data calculator form into an open dialog field.
	Load the tool radius into the cutting data calculator form
	Load the spindle speed from the open dialog field into the cutting data calculator form
	Load the feed rate from the open dialog field into the cutting data calculator form
	Load the feed per revolution from the open dialog field into the cutting data calculator form
	Load the feed per tooth from the open dialog field into the cutting data calculator form
	Load the value from an open dialog field into the cutting data calculator form
	Switch to the pocket calculator
	Move the cutting data calculator in the direction of the arrow
	Use inch values in the cutting data calculator
	Close the cutting data calculator

## 5.8 Programming graphics

### Activating and deactivating programming graphics

While you are writing an NC program, you can have the control generate a 2-D pencil-trace graphic of the programmed contour.

- ▶ Press the **Screen layout** key
- ▶ Press the **PROGRAM + GRAPHICS** soft key
- > The control shows the NC program to the left and graphics to the right.

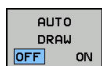

- ▶ Set the **AUTO DRAW** soft key to **ON**
- > While you are entering the program lines, the control generates each programmed movement in the graphics window in the right screen half.

If you do not wish to have the control generate graphics during programming, set the **AUTO DRAW** soft key to **OFF**.



If **AUTO DRAW** is set to **ON**, the control ignores the following program content when creating 2-D pencil-trace graphics:

- Program section repetitions
- Jump commands
- M functions, such as M2 or M30
- Cycle calls
- Warnings due to locked tools

Therefore, only use automatic drawing during contour programming.

The control resets the tool data if you reopen a program or press the **RESET + START** soft key.

The control uses various colors in the programming graphics:

- **blue**: uniquely specified contour element
- **violet**: not yet uniquely specified contour element, can still be modified by e.g. an RND
- **light blue**: holes and threads
- **ocher**: tool midpoint path
- **red**: rapid traverse

**Further information:** "FK programming graphics", page 309

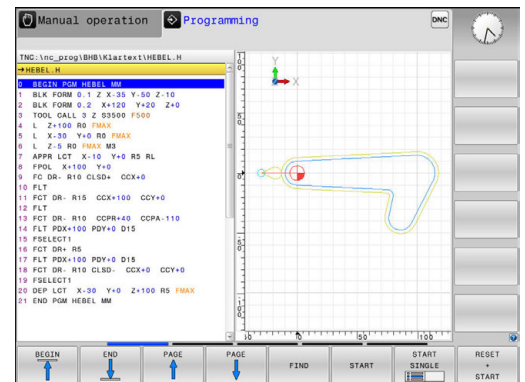

### Generating a graphic for an existing program

- ▶ Use the arrow keys to select the block up to which you want the graphic to be generated, or press **GOTO** and enter the desired block number



- ▶ Reset previously active tool data and generate graphics: Press the **RESET + START** soft key

#### Additional functions:

Soft key	Function
	Reset previously active tool data. Generate programming graphics
	Generate programming graphic blockwise
	Generate a complete graphic or complete it after <b>RESET + START</b>
	Stop the programming graphics. This soft key only appears while the control is generating the programming graphics
	Selecting views <ul style="list-style-type: none"> <li>■ Plan view</li> <li>■ Front view</li> <li>■ Page view</li> </ul>
	Display or hide tool paths
	Display or hide tool paths in rapid traverse

## Block number display ON/OFF



- ▶ Shift the soft-key row

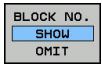

- ▶ To show block numbers: Set the **BLOCK NO. SHOW OMIT** soft key to **SHOW**
- ▶ To hide block numbers: Set the **BLOCK NO. SHOW OMIT** soft key to **OMIT**

## Erasing the graphic



- ▶ Shift the soft-key row

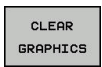

- ▶ Erase the graphics: Press the **CLEAR GRAPHICS** soft key

## Showing grid lines



- ▶ Shift the soft-key row

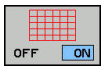







- ▶ Show grid lines: Press the **Show grid lines** soft key

### Magnification or reduction of details

You can select the graphics display

- ▶ Shift the soft-key row

The following functions are available:

Soft key	Function
 	Shift section
 	
	Reduce section
	Enlarge section
	Reset section

With the **RESET BLK FORM** soft key, you can restore the original section.

You can also use the mouse to change the graphic display. The following functions are available:

- To shift the model shown, hold the center mouse button or mouse wheel down and move the mouse. If you simultaneously press the shift key, you can only shift the model horizontally or vertically.
- To zoom in on a certain area, mark a zoom area by holding the left mouse button down. After you release the left mouse button, the control zooms in on the defined area.
- To rapidly magnify or reduce any area, rotate the mouse wheel backwards or forwards.

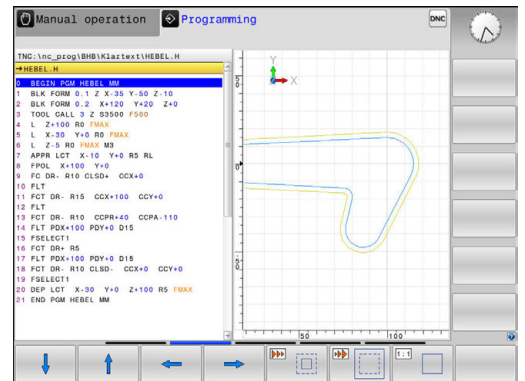

## 5.9 Error messages

### Display of errors

The control displays error messages in the following cases, for example:

- Incorrect data input
- Logical errors in the NC program
- Contour elements that are impossible to machine
- Incorrect use of touch probes

When an error occurs, the control displays it in red type in the header.



The control uses different colors for different error classes:

- red for errors
- yellow for warnings
- green for notes
- blue for information

Long and multi-line error messages are displayed in abbreviated form. Complete information on all pending errors is shown in the error window.

The control displays an error message in the header until it is cleared or replaced by a higher-priority error (higher error class). Information that appears only briefly is always displayed.

An error message that contains an NC block number was caused by an error in the indicated NC block or in the preceding NC block.

If a rare **processor check error** should occur, the control automatically opens the error window. You cannot correct such an error. Shut down the system and restart the control.

### Opening the error window

ERR

- ▶ Press the **ERR** key
- > The control opens the error window and displays all accumulated error messages.

### Closing the error window

END

- ▶ Press the **END** soft key; or

ERR

- ▶ Press the **ERR** key
- > The control closes the error window.



### Detailed error messages

The control displays possible causes of the error and suggestions for solving the problem:

- ▶ Open the error window



- ▶ Information on the error cause and corrective action: Position the cursor on the error message and press the **MORE INFO** soft key
- ▶ The control opens a window with information on the error cause and corrective action.
- ▶ Leave Info: Press the **MORE INFO** soft key again

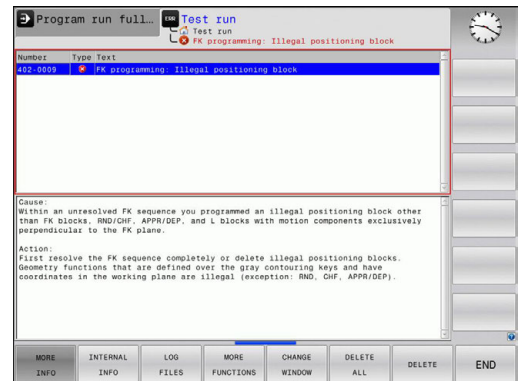

### INTERNAL INFO soft key

The **INTERNAL INFO** soft key supplies information on the error message. This information is only required if servicing is needed.

- ▶ Open the error window



- ▶ Detailed information about the error message: Position the cursor on the error message and press the **INTERNAL INFO** soft key
- ▶ The control opens a window with internal information about the error.
- ▶ To exit Details, press the **INTERNAL INFO** soft key again

### FILTER soft key

The **FILTER** soft key enables you to filter identical warnings listed immediately in succession.

- ▶ Open the error window

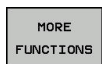

- ▶ Press the **MORE FUNCTIONS** soft key

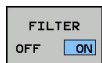

- ▶ Press the **FILTER** soft key The control filters the identical warnings



- ▶ Leave Filter: Press the **GO BACK** soft key

## Clearing errors

### Clearing errors outside of the error window

-  ▶ Clear the errors/messages in the header: Press the **CE** key

 In certain situations you cannot use the **CE** key for clearing the errors because the key is used for other functions.

### Clearing errors

- ▶ Open the error window

-  ▶ Clear individual errors: Position the cursor on the error message and press the **DELETE** soft key.

-  ▶ Clear all error messages: Press the **DELETE ALL** soft key.

 If the cause of the error has not been corrected, the error message cannot be cleared. In this case, the error message remains in the window.

## Error log

The control stores errors occurred and important events (e.g. system start) in an error log. The capacity of the error log is limited. If the log is full, the control uses a second file. If this is also full, the first error log is deleted and newly written etc. If required, switch from **CURRENT FILE** to **PREVIOUS FILE** to view the history.

- ▶ Open the error window.

-  ▶ Press the **LOG FILES** soft key

-  ▶ Open the error log file: Press the **ERROR LOG** soft key





-  ▶ Set the previous error log if required: Press the **PREVIOUS FILE** soft key

-  ▶ Set the current error log if required: Press the **CURRENT FILE** soft key

The oldest entry is at the beginning of the log file, and the most recent entry is at the end.









### Keystroke log

The control stores each key pressed and important events (e.g. system start) in a keystroke log. The capacity of the keystroke log is limited. If the keystroke log is full, the control switches to a second keystroke log. If this is also full, the first keystroke log is deleted and newly written etc. If required, switch from **CURRENT FILE** to **PREVIOUS FILE** to view the history of the inputs.

-  ▶ Press the **LOG FILES** soft key
-  ▶ Open the keystroke log file: Press the **KEYSTROKE LOG** soft key
-  ▶ Set the previous keystroke log if required: Press the **PREVIOUS FILE** soft key
-  ▶ Set the current keystroke log if required: Press the **CURRENT FILE** soft key

The control saves each key pressed during operation in a keystroke log. The oldest entry is at the beginning, and the most recent entry is at the end of the file.

### Overview of the keys and soft keys for viewing the log

Soft key/Keys	Function
	Go to beginning of keystroke log
	Go to end of keystroke log
	Find text
	Current keystroke log
	Previous keystroke log
	Up/down one line
	
	Return to main menu

## Informational texts

If an operating error occurred, e.g. pressing an impermissible key or entering a value outside of a validity range, the control displays an information text in the header to inform you of the operating error. The control deletes this information text with the next valid entry.

## Saving service files

If necessary, you can save the current status of the control and make it available to a service technician for evaluation. A group of service files is saved (error and keystroke logs as well as other files that contain information about the current status of the machine and the machining).

If you repeat the **SAVE SERVICE FILES** function with the same file name, the previously saved group of service files is overwritten. Therefore, use another file name when executing the function another time.

### Saving service files

- ▶ Open the error window



- ▶ Press the **LOG FILES** soft key



- ▶ Press the **SAVE SERVICE FILES** soft key
- ▶ The control opens a pop-up window in which you can enter a file name or a complete path for the service file.



- ▶ Save the service files: Press the **OK** soft key

## Calling the TNCguide help system

You can call the control's help system via soft key. Immediately the help system shows you the same error explanation that you receive by pressing the **HELP** soft key.



Refer to your machine manual.

If your machine manufacturer also provides a help system, the control shows an additional **Machine manufacturer (OEM)** soft key with which you can call this separate help system. There you will find further, more detailed information on the error message concerned.



- ▶ Call the help for HEIDENHAIN error messages



- ▶ Call the help for HEIDENHAIN machine-specific error messages, if available

## 5.10 TNCguide context-sensitive help system

### Application



Before you can use the TNCguide, you need to download the help files from the HEIDENHAIN home page

**Further information:** "Downloading current help files", page 226

The **TNCguide** context-sensitive help system contains the user documentation in HTML format. The TNCguide is called with the **HELP** key, and the control often immediately displays the information specific to the condition from which the help was called (context-sensitive call). Even if you are editing an NC block and press the **HELP** key, you are usually brought to the exact place in the documentation that describes the corresponding function.



The control tries to start the TNCguide in the language that you have selected as the conversational language. If the required language version is not available, the control automatically opens the English version.

The following user documentation is available in TNCguide:

- Conversational Programming User's Manual (**BHBKlartext.chm**)
- ISO User's Manual (**BHBIso.chm**)
- Cycle Programming User's Manual (**BHBtchprobe.chm**)
- List of All Error Messages (**errors.chm**)

In addition, the **main.chm** "book" file is available, with the contents of all existing .chm files.



As an option, your machine tool builder can embed machine-specific documentation in the **TNCguide**. These documents then appear as a separate book in the **main.chm** file.

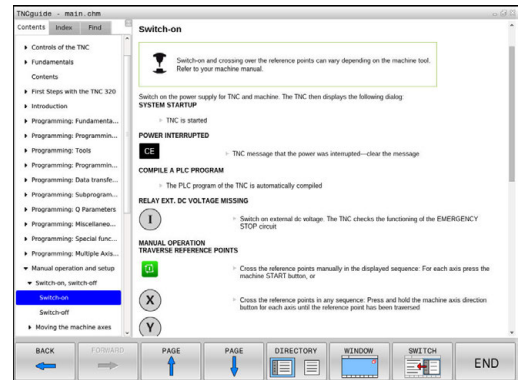

## Working with TNCguide

### Calling TNCguide

There are several ways to start the TNCguide:

- ▶ Press the **HELP** key.
- ▶ Click the help symbol at the lower right of the screen beforehand, then click the appropriate soft keys
- ▶ Open a help file (CHM file) via the file management. The control can open any .chm file, even if it is not saved in the control's internal memory



On the Windows programming station, the TNCguide is opened in the internally defined standard browser.

For many soft keys there is a context-sensitive call through which you can go directly to the description of the soft key's function. This functionality requires using a mouse. Proceed as follows:

- ▶ Select the soft-key row containing the desired soft key
- ▶ Click with the mouse on the help symbol that the control displays just above the soft-key row
- ▶ The mouse pointer turns into a question mark.
- ▶ Move the question mark to the soft key for which you want an explanation
- ▶ The control opens the TNCguide. If there is no entry point for the selected soft key, then the control opens the book file **main.chm**. You can search for the desired explanation using full text search or by using the navigation.

Even if you are editing an NC block, context-sensitive help is available:

- ▶ Select any NC block
- ▶ Select the desired word
- ▶ Press the **HELP** key.
- ▶ The control opens the Help system and shows the description of the active function. This does not apply for miscellaneous functions or cycles from your machine manufacturer.

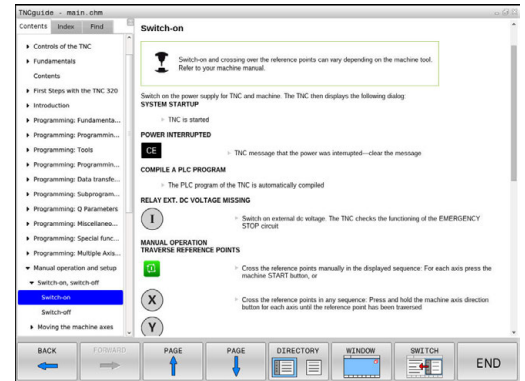

















**Navigating in the TNCguide**

It's easiest to use the mouse to navigate in TNCguide. A table of contents appears on the left side of the screen. By clicking the rightward pointing triangle you open subordinate sections, and by clicking the respective entry you open the individual pages. It is operated in the same manner as the Windows Explorer.

Linked text positions (cross references) are shown underlined and in blue. Clicking the link opens the associated page.

Of course you can also operate TNCguide through keys and soft keys. The following table contains an overview of the corresponding key functions.

Soft key	Function
	<ul style="list-style-type: none"> <li>■ If the table of contents at left is active: Select the entry above it or below it</li> </ul>
	<ul style="list-style-type: none"> <li>■ If the text window at right is active: Move the page downward or upward if texts or graphics are not shown completely</li> </ul>
	<ul style="list-style-type: none"> <li>■ If the table of contents at left is active: Open up the table of contents</li> <li>■ If the text window at right is active: No function</li> </ul>
	<ul style="list-style-type: none"> <li>■ If the table of contents at left is active: Close the table of contents</li> <li>■ If the text window at right is active: No function</li> </ul>
	<ul style="list-style-type: none"> <li>■ If the table of contents at left is active: Use the cursor key to show the selected page</li> <li>■ If the text window at right is active: If the cursor is on a link, jump to the linked page</li> </ul>
	<ul style="list-style-type: none"> <li>■ If the table of contents at left is active: Switch the tab between the display of the table of contents, display of the subject index, and the full-text search function and switching to the screen half at right</li> <li>■ If the text window at right is active: Jump back to the window at left</li> </ul>
	<ul style="list-style-type: none"> <li>■ If the table of contents at left is active: Select the entry above it or below it</li> </ul>
	<ul style="list-style-type: none"> <li>■ If the text window at right is active: Jump to next link</li> </ul>
	Select the page last shown
	Page forward if you have used the <b>Select page last shown</b> function
	Move up by one page
	Move down by one page

Soft key	Function
	Display or hide table of contents
	Switch between full-screen display and reduced display. With the reduced display you can see some of the rest of the control window
	The focus is switched internally to the control application so that you can operate the control when the TNCguide is open. If the full screen is active, the control reduces the window size automatically before the change of focus
	Exit TNCguide

### Subject index

The most important subjects in the Manual are listed in the subject index (**Index** tab). You can select them directly by mouse or with the arrow keys.

The left side is active.



- ▶ Select the **Index** tab
- ▶ Use the arrow keys or the mouse to select the desired keyword

Alternative:

- ▶ Enter the first few characters
- ▶ The control synchronizes the subject index and creates a list in which you can find the subject more easily.
- ▶ Use the **ENT** key to call the information on the selected keyword

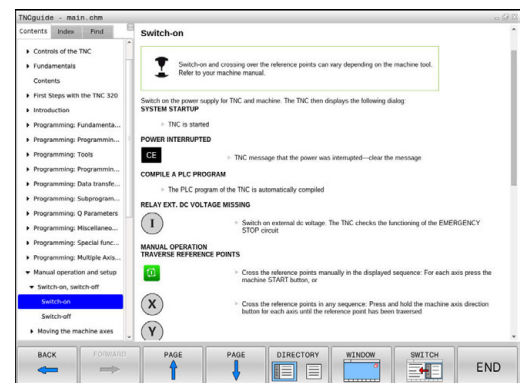



### Full-text search

In the **Find** tab you can search all of TNCguide for a specific word. The left side is active.



- ▶ Select the **Find** tab
- ▶ Activate the **Find:** entry field
- ▶ Enter the search word
- ▶ Press the **ENT** key
- > The control lists all sources containing the word.
- ▶ Use the arrow keys to navigate to the desired source
- ▶ Press the **ENT** key to go to the selected source



The full-text search only works for single words.

If you activate the **Search only in titles** function, the control searches only through headings and ignores the body text. To activate the function, use the mouse or select it and then press the space bar to confirm.

## Downloading current help files

You'll find the help files for your control software on the HEIDENHAIN homepage:

**[http://content.heidenhain.de/doku/tnc\\_guide/html/en/index.html](http://content.heidenhain.de/doku/tnc_guide/html/en/index.html)**

Navigate to the suitable help file as follows:

- ▶ TNC Controls
- ▶ Series, e.g. TNC 600
- ▶ Desired NC software number, e.g. TNC 620 (81760x-04)
- ▶ Select the desired language version from the **TNCguide online help** table
- ▶ Download the ZIP file
- ▶ Extract the ZIP file
- ▶ Move the extracted CHM files to the **TNC:\tncguide\en** directory or the respective language subdirectory on the control



When using TNCremo to transfer the .chm files to the control, select the binary mode for files with the **.chm** extension.

<b>Language</b>	<b>TNC directory</b>
German	TNC:\tncguide\de
English	TNC:\tncguide\en
Czech	TNC:\tncguide\cs
French	TNC:\tncguide\fr
Italian	TNC:\tncguide\it
Spanish	TNC:\tncguide\es
Portuguese	TNC:\tncguide\pt
Swedish	TNC:\tncguide\sv
Danish	TNC:\tncguide\da
Finnish	TNC:\tncguide\fi
Dutch	TNC:\tncguide\nl
Polish	TNC:\tncguide\pl
Hungarian	TNC:\tncguide\hu
Russian	TNC:\tncguide\ru
Chinese (simplified)	TNC:\tncguide\zh
Chinese (traditional)	TNC:\tncguide\zh-tw
Slovenian	TNC:\tncguide\sl
Norwegian	TNC:\tncguide\no
Slovak	TNC:\tncguide\sk
Korean	TNC:\tncguide\kr
Turkish	TNC:\tncguide\tr
Romanian	TNC:\tncguide\ro



# 6

**Tools**

## 6.1 Entering tool-related data

### Feed rate F

The feed rate **F** is the speed at which the tool center point moves. The maximum feed rates can be different for the individual axes and are set in machine parameters.

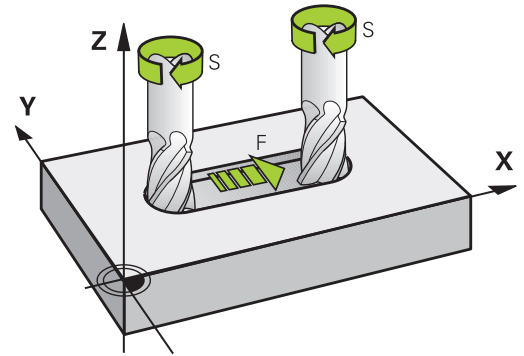

### Input

You can enter the feed rate in the **TOOL CALL** block and in every positioning block.

**Further information:** "Creating the NC blocks with the path function keys", page 276

You enter the feed rate **F** in mm/min in millimeter programs, and in 1/10 inch/min in inch-programs, for resolution reasons. Alternatively, with the corresponding soft keys, you can also define the feed rate in mm per revolution (mm/1) **FU** or in mm per tooth (mm/tooth) **FZ**.

### Rapid traverse

If you wish to program rapid traverse, enter **F MAX**. To enter **F MAX**, press the **ENT** key or the **F MAX** soft key when the dialog question **FEED RATE F = ?** appears on the control's screen.



To move your machine at rapid traverse, you can also program the corresponding numerical value, e.g. **F30000**. Unlike **F MAX**, this rapid traverse remains in effect not only in the individual block but in all blocks until you program a new feed rate.

### Duration of effect

A feed rate entered as a numerical value remains in effect until a block with a different feed rate is reached. **F MAX** is only effective in the block in which it is programmed. After the block with **F MAX** is executed, the feed rate will return to the last feed rate entered as a numerical value.

### Changing during program run

You can adjust the feed rate during the program run with the feed rate potentiometer F.

The feed rate potentiometer lowers the programmed feed rate, not the feed rate calculated by the control.

## Spindle speed S

The spindle speed S is entered in revolutions per minute (rpm) in a **TOOL CALL** block (tool call). Instead, you can also define the cutting speed Vc in meters per minute (m/min).

### Programmed change

In the NC program, you can change the spindle speed in a **TOOL CALL** block by entering the spindle speed only:

TOOL  
CALL

- ▶ Program a tool call: Press the **TOOL CALL** key
- ▶ Ignore the dialog question for **Tool number ?** with the **NO ENT** key
- ▶ Ignore the dialog question for **Working spindle axis X/Y/Z ?** with the **NO ENT** key
- ▶ Enter the new spindle speed for the dialog question **Spindle speed S= ?**, and confirm with **END**, or switch via the **VC** soft key to entry of the cutting speed.



If the number of the already inserted tool is entered in the **TOOL CALL** block without specifying the tool axis, then only the spindle speed will change.

If the tool axis is also entered in the **TOOL CALL** block, the control will insert a replacement tool if a replacement tool was defined.

### Changing during program run

You can adjust the spindle speed during program run with the spindle speed potentiometer S.

## 6.2 Tool data

### Requirements for tool compensation

You usually program the coordinates of path contours as they are dimensioned in the workpiece drawing. To allow the control to calculate the tool center path (i.e. the tool compensation) you must also enter the length and radius of each tool you are using.

Tool data can be entered either directly in the part program with **TOOL DEF** or separately in a tool table. In a tool table, you can also enter additional data for the specific tool. The control will consider all the data entered for the tool when executing the part program.

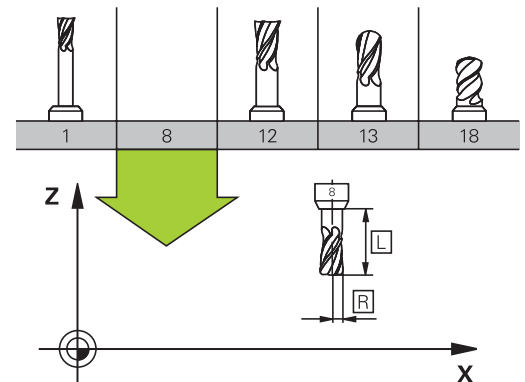

### Tool number, tool name

Each tool is identified by a number between 0 and 32767. If you are working with tool tables, you can also enter a tool name for each tool. Tool names can have up to 32 characters.



**Permitted special characters:** # \$ % & , - \_ . 0 1 2 3 4 5  
6 7 8 9 @ A B C D E F G H I J K L M N O P Q R S T U V  
W X Y Z

The control automatically replaces lowercase letters with corresponding uppercase letters during saving.

**Impermissible characters:** <blank space> ! " ' ( ) \* + ; ;  
< = > ? [ / ] ^ ` { | } ~

The tool number 0 is automatically defined as the zero tool with the length  $L=0$  and the radius  $R=0$ . In tool tables, tool T0 should also be defined with  $L=0$  and  $R=0$ .

### Tool length L

You should always enter the tool length L as an absolute value based on the tool reference point. The entire tool length is essential for the control in order to perform numerous functions involving multi-axis machining.

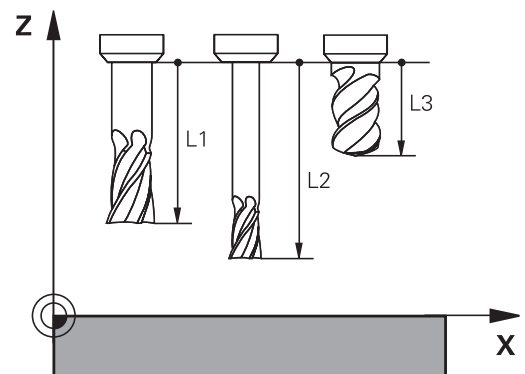

### Tool radius R

You can enter the tool radius R directly.



## Delta values for lengths and radii

Delta values are offsets in the length and radius of a tool.

A positive delta value describes a tool oversize (**DL**, **DR**>0). If you are programming the machining data with an allowance, enter the oversize value in the **TOOL CALL**.

A negative delta value describes a tool undersize (**DL**, **DR**<0). An undersize is entered in the tool table for wear.

Delta values are usually entered as numerical values. In a **TOOL CALL** block, you can also assign the values to Q parameters.

Input range: You can enter a delta value with up to  $\pm 99.999$  mm.

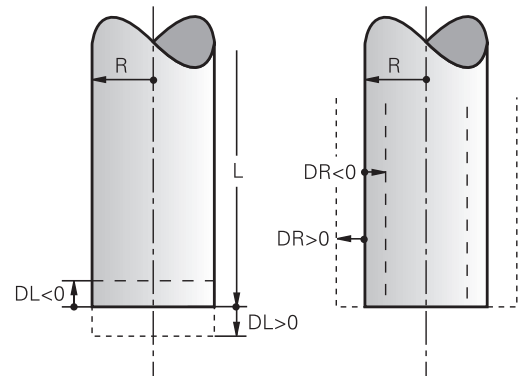

**i** Delta values from the tool table influence the graphical representation of the clearing simulation. Delta values from the **TOOL CALL** block do not change the represented size of the **tool** during the simulation. However, the programmed delta values move the **tool** by the defined value in the simulation.

**i** Delta values from the **TOOL CALL** block influence the position display depending on the optional machine parameter **progToolCallDL** (no. 124501).

## Entering tool data into the NC program

**⚙** Refer to your machine manual. The machine tool builder determines the scope of functions of the **TOOL DEF** function.

The number, length and radius of a specific tool is defined in the **TOOL DEF** block of the part program:

- ▶ Select the tool definition: Press the **TOOL DEF** key

**TOOL DEF**

- ▶ **Tool number:** Each tool is uniquely identified by its tool number
- ▶ **Tool length:** Compensation value for the tool length
- ▶ **Tool radius:** Compensation value for the tool radius

**i** In the programming dialog, you can transfer the value for tool length and tool radius directly into the input line by pressing the desired axis soft key.

## Example

```
4 TOOL DEF 5 L+10 R+5
```

## Entering tool data into the table

You can define and store up to 32 767 tools and their tool data in a tool table. Also see the editing functions later in this chapter.

You must use tool tables if:

- you wish to use indexed tools such as stepped drills with more than one length compensation value  
**Further information:** "Indexed tool", page 235
- your machine tool has an automatic tool changer
- you want to work with the machining cycle 22,  
**Further information:** Cycle Programming User's Manual
- you want to work with machining cycles 251 to 254,  
**Further information:** Cycle Programming User's Manual

### NOTICE

#### Caution: Data may be lost!

Deleting line 0 from the tool table will destroy the structure of the table. As a result, locked tools might no longer be recognized as locked and, consequently, the search for a replacement tool will not work, either. The problem cannot be solved by reinserting a line 0. The original tool table will be permanently damaged!

- ▶ Restore the tool table
  - Add a new line 0 to the defective tool table
  - Copy the defective tool table (e.g. toolcopy.t)
  - Delete the defective tool table (current tool.t)
  - Copy the copied tool table (toolcopy.t) as tool.t
  - Delete the copied tool table (toolcopy.t)
- ▶ Contact HEIDENHAIN Service (NC helpline)



All table names must start with a letter. Please keep this in mind when creating and managing additional tables.

You can select the table view with the **Screen Layout** key. You can choose between a list view and a form view.

Other settings, such as **HIDE/ SORT/ COLUMNS**, can be made after the file is open.

### Indexed tool

Step drills, T-slot milling cutters, side milling cutters and, in generally, all tools that require the input of multiple length and radius data cannot be fully defined in a single line of the tool table. Each line of the table permits the definition of one length and one radius.

In order to assign multiple compensation data to a tool (multiple tool table lines), add an indexed tool number (such as **T 5.1**) to an existing tool definition (**T 5**). Each additional line of the table thus comprises the original tool number, a period and an index (in ascending order from 1 to 9). The original tool table line contains the maximum tool length; the tool lengths in the subsequent table lines are given in descending order of their distance to the tool holder point.

Proceed as follows to create an indexed tool number (table line):

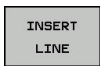

- ▶ Open the tool table
- ▶ Press the **Insert Line** soft key
- > The control opens the **Insert Line** pop-up window
- ▶ In the **Number of new lines =** input field, enter the number of lines to add
- ▶ Enter the original tool number into the **Tool number** input field
- ▶ Confirm with **OK**
- > The control adds the additional lines to the tool table

**Quick search for the tool name:**

If the **EDIT** soft key is set to **OFF**, you can search for a tool name. Proceed as follows:

- ▶ Enter the first few characters of the tool name, e.g. **MI**
- > The control shows a dialog box with the entered text and jumps to the first match.
- ▶ Enter additional characters to narrow down the search result, e.g. **MILL**
- ▶ If the control cannot find any more matches for the entered search string, you can press the last entered character (e.g. **L**) to jump between matches, as with the arrow keys.

The quick search can also be used for tool selection in the **TOOL CALL** block.

**Tool table: Standard tool data**

Abbr.	Inputs	Dialog
<b>T</b>	Number by which the tool is called in the program (e.g. 5, indexed: 5.2)	-
<b>NAME</b>	Name by which the tool is called in the program (max. 32 characters, all capitals, no spaces)	<b>Tool name?</b>
<b>L</b>	Tool length L	<b>Tool length?</b>
<b>R</b>	Tool radius R	<b>Tool radius?</b>
<b>R2</b>	Tool radius R2 for toroid cutters (only for 3-D radius compensation or graphical representation of a machining operation with spherical or toroid cutters)	<b>Tool radius 2?</b>
<b>DL</b>	Delta value for tool length L	<b>Tool length oversize?</b>
<b>DR</b>	Delta value for tool radius R	<b>Tool radius oversize?</b>
<b>DR2</b>	Delta value for tool radius R2	<b>Tool radius oversize 2?</b>
<b>TL</b>	Set tool lock ( <b>TL</b> for <b>T</b> ool <b>L</b> ocked)	<b>Tool locked? Yes=ENT/ No=NOENT</b>
<b>RT</b>	Number of a replacement tool – if available – as replacement tool ( <b>RT</b> : for <b>R</b> eplacement <b>T</b> ool) An empty field or input <b>0</b> means no replacement tool has been defined.	<b>Replacement tool?</b>
<b>TIME1</b>	Maximum tool life in minutes. This function can vary depending on the individual machine tool. Your machine manual provides more information	<b>Maximum tool age?</b>
<b>TIME2</b>	Maximum tool life in minutes during a tool call: If the current tool age reaches or exceeds this value, the control inserts the replacement tool during the next <b>TOOL CALL</b> (if the tool axis is specified)	<b>Max. tool age for TOOL CALL?</b>
<b>CUR_TIME</b>	Current age of the tool in minutes: The control automatically counts the current tool life ( <b>CUR_TIME</b> : For <b>CUR</b> rent <b>TIME</b> ) A starting value can be entered for used tools	<b>Current tool age?</b>

Abbr.	Inputs	Dialog
TYPE	Tool type: Press the <b>ENT</b> key to edit the field. The <b>GOTO</b> key opens a window for selecting the tool type (in the tool management, press the <b>SELECT</b> soft key to open a pop-up window). You can assign tool types to specify the display filter settings such that only the selected type is visible in the table	Tool type?
DOC	Comment on tool (max. 32 characters)	Tool description
PLC	Information on this tool that is to be sent to the PLC	PLC status?
LCUTS	Tooth length of the tool for Cycles 22, 233, 256, 257	Tooth length in the tool axis?
ANGLE	Maximum plunge angle of the tool for reciprocating plunge-cut in Cycles 22 and 208	Maximum plunge angle?
NMAX	Limit the spindle speed for this tool. The programmed value is monitored (error message) as well as an increase in the shaft speed via the potentiometer. Function inactive: Enter -. <b>Input range:</b> 0 to +999 999 if function not active: enter -	Maximum speed [rpm]
LIFTOFF	Definition of whether the control should retract the tool in the direction of the positive tool axis at an NC stop in order to avoid leaving dwell marks on the contour. If <b>Y</b> is defined, the control retracts the tool from the contour, provided <b>M148</b> has been activated. <b>Further information:</b> "Automatically retracting the tool from the contour at an NC stop: M148", page 487	Retract allowed? Yes=ENT/ No=NOENT
TP_NO	Reference to the number of the touch probe in the touch-probe table	Number of the touch probe
T-ANGLE	Point angle of the tool. Is used by the Centering cycle (Cycle 240) in order to calculate the centering depth from the diameter entry	Point angle
PITCH	Thread pitch of the tool. Used by tapping cycles (Cycle 206, Cycle 207 and Cycle 209). A positive algebraic sign means a right-hand thread.	Tool thread pitch?
LAST_USE	Date and time that the tool was last inserted via <b>TOOL CALL</b>	Date/time of last tool call
PTYP	Tool type for evaluation in the pocket table Function is defined by the machine manufacturer. Refer to your machine manual.	Tool type for pocket table?

Abbr.	Inputs	Dialog
<b>ACC</b>	Activate or deactivate active chatter control for the respective tool (page 498). <b>Input range:</b> N (inactive) and Y (active)	<b>ACC active? Yes=ENT/No=NOENT</b>
<b>KINEMATIC</b>	Press the <b>SELECT</b> soft key to display the tool carrier kinematics (in the tool management, press the <b>SELECT</b> soft key) and press the <b>OK</b> soft key to confirm the file name and path. <b>Further information:</b> "Allocating parameterized tool carriers", page 497	<b>Tool-carrier kinematics</b>
<b>OVRTIME</b>	Time for exceeding the tool life in minutes <b>Further information:</b> "Overtime for tool life", page 253 Function is defined by the machine manufacturer. Refer to your machine manual.	<b>Tool life expired</b>

**Tool table: Tool data required for automatic tool measurement**

Refer to your machine manual.

The machine tool builder defines whether the **R-OFFS** offset will be taken into account for a tool with **CUT 0**.

Abbr.	Inputs	Dialog
<b>CUT</b>	Number of teeth (99 teeth maximum)	<b>Number of teeth?</b>
<b>LTOL</b>	Permissible deviation from tool length L for wear detection. If the entered value is exceeded, the control locks the tool (status <b>L</b> ). Input range: 0 to 0.9999 mm	<b>Wear tolerance: length?</b>
<b>RTOL</b>	Permissible deviation from tool radius R for wear detection. If the entered value is exceeded, the control locks the tool (status <b>L</b> ). Input range: 0 to 0.9999 mm	<b>Wear tolerance: radius?</b>
<b>R2TOL</b>	Permissible deviation from tool radius R2 for wear detection. If the entered value is exceeded, the control locks the tool (status <b>L</b> ). Input range: 0 to 0.9999 mm	<b>Wear tolerance: Radius 2?</b>
<b>DIRECT</b>	Cutting direction of the tool for measuring the tool during rotation	<b>Cutting direction? M4=ENT/ M3=NOENT</b>
<b>R-OFFS</b>	Tool length measurement: Tool offset between stylus center and tool center. Default setting: No value entered (offset = tool radius)	<b>Tool offset: radius?</b>
<b>L-OFFS</b>	Tool radius measurement: tool offset in addition to <b>offsetToolAxis</b> between upper surface of stylus and lower surface of tool. Default: 0	<b>Tool offset: length?</b>
<b>LBREAK</b>	Permissible deviation from tool length <b>L</b> for breakage detection. If the entered value is exceeded, the control locks the tool (status <b>L</b> ). Input range: 0 to 3.2767 mm	<b>Breakage tolerance: length?</b>
<b>RBREAK</b>	Permissible deviation from tool radius R for breakage detection. If the entered value is exceeded, the control locks the tool (status <b>L</b> ). Input range: 0 to 0.9999 mm	<b>Breakage tolerance: radius?</b>



For a description of the cycles governing automatic tool measurement,

**Further information:** Cycle Programming User's Manual

## Editing the tool table

The tool table that is active during execution of the part program is designated TOOL.T and must be saved in the **TNC:\table** directory.

Other tool tables that are to be archived or used for test runs are given different file names with the extension .T. By default, for the **Test Run** and **Programming** modes the control also uses the TOOL.T tool table. In the **Test Run** mode, press the **TOOL TABLE** soft key to edit it.

To open the tool table TOOL.T:

- ▶ Select any machine operating mode



- ▶ Select the tool table: Press the **TOOL TABLE** soft key



- ▶ Set the **EDIT** soft key to **ON**

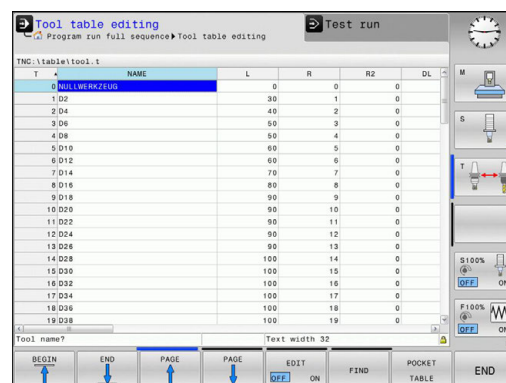

If you edit the tool table, the selected tool is locked. If this tool is required in the NC program being used, the control shows the message: **Tool table locked**.

If a new tool is created, the length and radius columns remain empty until entered manually. An attempt to insert such a newly created tool will be aborted by the control and an error message will appear. This means you cannot insert a tool for which no geometry data are available yet.

Proceed as follows to use the keyboard or a connected mouse for navigation and editing:

- Arrow keys: move from one cell to the next
- ENT key: jump to the next cell; with selection fields: open the selection dialog
- Mouse click on a cell: move to the cell
- Double click on a cell: place the cursor in the cell; with selection fields: open the selection dialog

Soft key	Editing functions of the tool table
	Select the table start
	Select the table end
	Select the previous page in the table
	Select the next page in the table
	Find the text or number
	Go to beginning of line



Soft key	Editing functions of the tool table
END LINE 	Go to end of line
COPY FIELD	Copy active field
PASTE FIELD	Insert copied field
APPEND N LINES	Add the entered number of lines (tools) at the end of the table
INSERT LINE	Insert a line with definable tool number
DELETE LINE	Delete the current line (tool)
SORT	Sort the tools according to the content of a column
SELECT	Select possible entries from a pop-up window
RESET COLUMN	Reset the value
EDIT CURRENT FIELD	Place the cursor in the current cell







### Displaying only specific tool types (filter setting)

- ▶ Press the **TABLE FILTER** soft key
- ▶ Select the desired tool type by soft key
- > The control displays only tools of the selected type.
- ▶ Cancel the filter: Press the **SHOW ALL** soft key



Refer to your machine manual.

The machine tool builder adapts the features of the filter function to the requirements of your machine.

Soft key	Filter functions of the tool table
	Select the filter function
	Cancel the filter settings and show all tools
	Use the default filter
	Show all drills in the tool table
	Show all cutters in the tool table
	Show all taps/thread cutters in the tool table
	Show all touch probes in the tool table

### Hiding or sorting the tool table columns

You can adapt the layout of the tool table to your needs. Columns that are not to be displayed can be simply hidden:

- ▶ Press the **HIDE/ SORT/ COLUMNS** soft key
- ▶ Select the appropriate column name with the arrow key
- ▶ Press the **HIDE COLUMN** soft key to remove this column from the table view

You can also modify the sequence of columns in the table:

- ▶ You can also modify the sequence of columns in the table with the **Move before:** dialog. The entry highlighted in **Displayed columns:** is moved in front of this column

Use a connected mouse or the control's keyboard to navigate in the form. Navigation using the control's keyboard:



- ▶ Press the navigation keys to go to the input fields.
- ▶ Use the arrow keys to navigate within an input field.
- ▶ To open pop-down menus, press the **GOTO** key.



The function **freeze number of columns** enables you to determine how many columns (0-3) the control will freeze to the left border of the screen. These columns will remain visible when you navigate to the right within the table.

### Opening any other tool table

- ▶ Select the **Programming** operating mode



- ▶ To call the file manager, press the PGM MGT key
- ▶ Select a file or enter a new file name. Confirm your entry with the **ENT** key or the **SELECT** soft key

When you have opened the tool table, you can edit the tool data by moving the cursor to the desired position in the table with the arrow keys or the soft keys. You can overwrite the stored values, or enter new values at any position.

**Further information:** "Editing the tool table", page 240

### Exiting any other tool table

- ▶ Call the file manager and select a file of a different type, such as an NC program

### Importing tool tables



Refer to your machine manual.

The machine tool builder can adapt the **ADAPT NC PGM / TABLE** function.

The machine tool builder can define update rules that make it possible, for example, to automatically remove umlauts from tables and NC programs.

If you export a tool table from an iTNC 530 and import it into a TNC 620, you have to adapt its format and content before you can use the tool table. On the TNC 620, you can adapt the tool table conveniently with the **ADAPT NC PGM / TABLE** function. The control converts the contents of the imported tool table to a format valid for the TNC 620 and saves the changes to the selected file.

Follow this procedure:

- ▶ Save the tool table of the iTNC 530 to the **TNC:\table** directory



- ▶ Select the **Programming** operating mode



- ▶ Press the **PGM MGT** key



- ▶ Move the cursor to the tool table you want to import

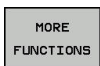

- ▶ Press the **MORE FUNCTIONS** soft key

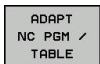

- ▶ Press the **ADAPT NC PGM / TABLE** soft key
- ▶ The control asks you whether you want to overwrite the selected tool table.
- ▶ Press the **CANCEL** soft key
- ▶ Alternative: Press the **OK** soft key to overwrite

- ▶ Open the converted table and check its contents
- > New columns in the tool table are highlighted green
- ▶ Press the **REMOVE UPDATE INFORMATION** soft key
- > The green columns are displayed in white again



The following characters are permitted in the **Name** column of the tool table: # \$ % & , - . 0 1 2 3 4 5 6 7 8 9 @ A B C D E F G H I J K L M N O P Q R S T U V W X Y Z

– During the import, a comma is converted to a period.

The control overwrites the active tool table when importing an external table with the same name. To prevent data loss, back up the original tool table before you start the import!

The procedure for copying tool tables using the file manager is described in the section on file management.

**Further information:** "Copying a table", page 178

When iTNC 530 tool tables are imported, all defined tool types are transferred as well. Tool types not present are imported as type **Undefined**. Check the tool table after the import.

## Overwriting tool data from an external PC

### Application

The HEIDENHAIN data transfer software TNCremo provides an especially convenient way to use an external PC to overwrite tool data.

**Further information:** "Software for data transfer", page 755

This application case occurs if you wish to determine tool data on an external tool presetter and then transfer this to the control.

### Requirements

In addition to option 18 HEIDENHAIN DNC, TNCremo (from version 3.1) is required with TNCremoPlus functions.

### Procedure

- ▶ Copy the TOOL.T tool table to the control, for example to TST.T
- ▶ Start the data transfer software TNCremo on the PC
- ▶ Connect to the control
- ▶ Transfer the copied tool table TST.T to the PC
- ▶ Use any text editor to reduce TST.T to the lines and columns to be changed (see figure). Make sure that the header is not changed and the data is always flush in the column. The tool number (column T) need not be consecutive
- ▶ In TNCremo, select the menu item <Extras> and <TNCcmd>: This starts TNCcmd.
- ▶ To transfer the TST.T file to the control, enter the following command and confirm with the return key (see figure):  
put tst.t tool.t /m



During transfer, only the tool data defined in the subfile (e.g. TST.T) is overwritten. All other tool data of the table TOOL.T remains unchanged.

The procedure for copying tool tables using the file manager is described in the file management.

**Further information:** "Copying a table", page 178

T	NAME	L	R
1		+12.5	+9
3		+23.15	+3.5

[END]

```
TNC640(340594) - TNCcmd
TNCcmdPlus - WIN32 Command Line Client for HEIDENHAIN Controls - Version: 5.92
Connecting with TNC640(340594) (192.168.56.101)
Connection established with TNC640, NC Software 340595 07 Dev
TNC:\nc_prog\> put tst.t tool.t /m
```

## Pocket table for tool changer



Refer to your machine manual.

The machine tool builder adapts the features of the pocket table to the requirements of your machine.

For automatic tool changing you need the a pocket table. You manage the assignment of your tool changer in the pocket table. The pocket table is in the **TNC:\table** directory. The machine manufacturer can amend the name, path and content of the pocket table. If you wish, you can select different views using the soft keys in the **TABLE FILTER** menu.

P	TNAME	RSV	ST	F	L	DOC
0 0	D10					
1.1	1 D2					Tool 1
1.2	2 D4					Tool 2
1.3	3 D6					Tool 3
1.4	4 D8					Tool 4
1.5	5 D10		R			
1.6	6 D12					
1.7	7 D14					
1.8	8 D16					
1.9	9 D18					
1.10	10 D20					
1.11	11 D22					
1.12	12 D24					
1.13	13 D26					
1.14	14 D28					
1.15	15 D30					
1.16	16 D32					
1.17	17 D34					
1.18	18 D36					
1.19	19 D38					

### Editing a pocket table in a Program Run operating mode



- ▶ Select the tool table: Press the **TOOL TABLE** soft key

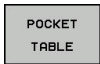

- ▶ Press the **POCKET TABLE** soft key



- ▶ Set the **EDIT** soft key to **ON**. On your machine this might not be necessary or even possible. Refer to your machine manual













### Selecting a pocket table in Programming mode

Proceed as follows to select the pocket table in the Programming mode of operation:



- ▶ To call the file manager, press the **PGM MGT** key.
- ▶ Press the **SHOW ALL** soft key
- ▶ Select a file or enter a new file name
- ▶ Confirm your entry with the **ENT** key or the **SELECT** soft key

Abbr.	Inputs	Dialog
<b>P</b>	Pocket number of the tool in the tool magazine	-
<b>T</b>	Tool number	<b>Tool number?</b>
<b>RSV</b>	Pocket reservation for box magazines	<b>Pocket reserv.: Yes = ENT / No = NOENT</b>
<b>ST</b>	Special tool ( <b>ST</b> ); If your special tool blocks pockets in front of and behind its actual pocket, these additional pockets need to be locked in column L (status L).	<b>Special tool?</b>
<b>F</b>	The tool is always returned to the same pocket in the tool magazine	<b>Fixed pocket? Yes = ENT / No = NO ENT</b>
<b>L</b>	Locked pocket ( <b>L</b> : for <b>L</b> ocked)	<b>Pocket locked Yes = ENT / No = NO ENT</b>
<b>DOC</b>	Display of the comment to the tool from TOOL.T	-
<b>PLC</b>	Information on this tool pocket that is to be sent to the PLC	<b>PLC status?</b>
<b>P1 ... P5</b>	Function is defined by the machine tool builder. The machine tool documentation provides further information	<b>Value?</b>
<b>PTYP</b>	Tool type. Function is defined by the machine tool builder. The machine tool documentation provides further information	<b>Tool type for pocket table?</b>
<b>LOCKED_ABOVE</b>	Box magazine: Lock the pocket above	<b>Lock the pocket above?</b>
<b>LOCKED_BELOW</b>	Box magazine: Lock the pocket below	<b>Lock the pocket below?</b>
<b>LOCKED_LEFT</b>	Box magazine: Lock the pocket at left	<b>Lock the pocket at left?</b>
<b>LOCKED_RIGHT</b>	Box magazine: Lock the pocket at right	<b>Lock the pocket at right?</b>

Soft key	Editing functions for pocket tables
	Select the table start
	Select the table end
	Select the previous page in the table
	Select the next page in the table
	Reset pocket table Depends on optional machine parameter <b>enableReset</b> (no.106102)
	Reset tool number T column Depends on machine parameter <b>showResetColumnT</b> (no.)
	Go to beginning of line
	Go to end of line
	Simulate a tool change
	Select a tool from the tool table: The control shows the contents of the tool table. Use the arrow keys to select a tool, press <b>OK</b> to transfer it to the pocket table
	Reset the value
	Place the cursor in the current cell
	Sort the view



Refer to your machine manual.

The machine manufacturer defines the features, properties and designations of the various display filters.



## Calling the tool data

Before you can call the tool, you have to define it in a **TOOL DEF** block or in the tool table.

A **TOOL CALL** in the NC program is programmed with the following data:



- ▶ Press the **TOOL CALL** key
- ▶ **Tool number**: Enter the number or name of the tool. With the **TOOL NAME** soft key you can enter a name. With the **QS** soft key you enter a string parameter. The control automatically places the tool name in quotation marks. You have to assign a tool name to a string parameter first. Names always refer to an entry in the active tool table TOOL.T.



- ▶ Alternative: Press the **SELECT** soft key
- ▶ The control opens a window where you can select a tool directly from the TOOL.T tool table.
- ▶ To call a tool with other compensation values, enter a decimal point followed by the index you defined in the tool table.
- ▶ **Working spindle axis X/Y/Z**: Enter the tool axis
- ▶ **Spindle speed S**: Enter the spindle speed S in revolutions per minute (rpm) Alternatively, you can define the cutting speed Vc in meters per minute (m/min). Press the **VC** soft key
- ▶ **Feed rate F**: Enter feed rate F in millimeters per minute (mm/min). Alternatively, you can define the feed rate in millimeters per revolution (mm/1) by pressing the **FU** soft key or in millimeters per tooth (mm/tooth) by pressing **FZ**. The feed rate is effective until you program a new feed rate in a positioning block or in a **TOOL CALL** block
- ▶ **Tool length oversize DL**: Enter the delta value for the tool length
- ▶ **Tool radius oversize DR**: Enter the delta value for the tool radius
- ▶ **Tool radius oversize DR2**: Enter the delta value for the tool radius 2





If the number of the already inserted tool is entered in the **TOOL CALL** block without specifying the tool axis, then only the spindle speed will change.

If the tool axis is also entered in the **TOOL CALL** block, the control will insert a replacement tool if a replacement tool was defined.

### Tool selection in the pop-up window

If you open a pop-up window for tool selection, the control marks all tools available in the tool magazine green.

You can search for a tool in the pop-up window:

- 
  - ▶ Press the **GOTO** key
  - ▶ Alternative: Press the **FIND** soft key
  - ▶ Enter the tool name or tool number
- 
  - ▶ Press the **ENT** key
  - ▶ The control goes to the first tool that matches the entered search string.

The following functions can be used with a connected mouse:

- You can sort the data in ascending or descending order by clicking a column of the table head.
- You can arrange the columns in any sequence you want by clicking a column of the table head and then moving it with the mouse key pressed down

The pop-up windows displayed for a tool number search and a tool name search can be configured separately. The sort order and the column widths are retained when the control is switched off.

### Tool call

Call tool number 5 in the tool axis Z with a spindle speed 2500 rpm and a feed rate of 350 mm/min. The tool length and tool radius 2 are to be programmed with an oversize of 0.2 and 0.05 mm, the tool radius with an undersize of 1 mm.

### Example

```
20 TOOL CALL 5.2 Z S2500 F350 DL+0.2 DR-1 DR2+0.05
```

The character **D** preceding **L**, **R** and **R2** designates delta values.

### Preselection of tools



Refer to your machine manual.

The preselection of tools with **TOOL DEF** can vary depending on the individual machine tool.

If you are working with tool tables, use a **TOOL DEF** block to preselect the next tool. Simply enter the tool number or a corresponding Q parameter, or type the tool name in quotation marks.

## Tool change

### Automatic tool change



Refer to your machine manual.

The tool change function can vary depending on the individual machine tool.

If your machine tool has automatic tool changing capability, the program run is not interrupted. When the control reaches a tool call with **TOOL CALL**, it replaces the inserted tool by another from the tool magazine.

### Automatic tool change if the tool life expires: M101



Refer to your machine manual.

The function of **M101** can vary depending on the individual machine tool.

When the specified tool life has expired, the control can automatically insert a replacement tool and continue machining with it. Activate the miscellaneous function **M101** for this. **M101** is reset with **M102**.

Enter the respective tool life after which machining is to be continued with a replacement tool in the **TIME2** column of the tool table. In the **CUR\_TIME** column the control enters the current tool life. If the current tool life is higher than the value entered in the **TIME2** column, a replacement tool will be inserted at the next possible point in the program no later than one minute after expiration of the tool life. The change is made only after the NC block has been completed.

The control performs the automatic tool change at a suitable point in the program. The automatic tool change is not performed:

- During execution of machining cycles
- While radius compensation (**RR/RL**) is active
- Directly after an approach function **APPR**
- Directly before a departure function **DEP**
- Directly before and after **CHF** and **RND**
- During execution of macros
- During execution of a tool change
- Directly after a **TOOL CALL** or **TOOL DEF**
- During execution of SL cycles

**NOTICE****Danger of collision!**

During an automatic tool change with **M101**, the control always retracts the tool in the tool axis first. There is danger of collision when retracting tools for machining undercuts, such as side milling cutters or T-slot milling cutters!

- ▶ Deactivate the tool change with **M102**

After the tool change the control positions the tool according to the following logic, unless otherwise specified by the machine tool builder:

- If the target position in the tool axis is below the current position, the tool axis is positioned last
- If the target position in the tool axis is above the current position, the tool axis is positioned first

Depending on the NC program, the machining time can increase as a result of the tool life verification and calculation of the automatic tool change. You can influence this with the optional entry element **BT** (block tolerance).

If you enter the **M101** function, the control continues the dialog by requesting **BT**. Here you define the number of NC blocks (1 - 100) by which the automatic tool change may be delayed. The resulting time period by which the tool change is delayed depends on the content of the NC blocks (e.g. feed rate, path). If you do not define **BT**, the control uses the value 1 or, if applicable, a default value defined by the machine manufacturer.



The higher the value of **BT**, the smaller will be the effect of an extended program duration through the **M101** function. Please note that this will delay the automatic tool change!

Use the formula **BT = 10: Average machining time of an NC block in seconds** to calculate a suitable starting value for **BT**. Round up to the next integer. If the calculated result is greater than 100, use the maximum input value of 100.

If you want to reset the current age of a tool (e.g. after changing the indexable inserts), enter the value 0 in the CUR\_TIME column.

**Overtime for tool life**

This feature must be enabled and adapted by the machine tool builder.

The tool condition at the end of planned tool life depends on e.g. the tool type, machining method and workpiece material. In the **OVRTIME** column of the tool table, enter the time in minutes for which the tool is permitted to be used beyond the tool life.

The machine manufacturer specifies whether this column is enabled and how it is used during tool search.

**Prerequisites for NC blocks with surface-normal vectors and 3-D compensation**

The active radius (**R + DR**) of the replacement tool must not deviate from the radius of the original tool. You can enter the delta values (**DR**) either in the tool table or in the **TOOL CALL** block.

With deviations, the control displays an error message and does not replace the tool. You can suppress this message with the M function **M107**, and reactivate it with **M108**.

**Further information:** "Three-dimensional tool compensation (option 9)", page 579

## Tool usage test

### Requirements



Refer to your machine manual.

The tool usage test function must be enabled by your machine tool builder.

To conduct a tool usage test, you must activate **Create tool usage files** in the MOD menu.

**Further information:** "Tool usage file", page 745

### Generating a tool usage file

Depending on the setting in the MOD menu, you have the following options for generating the tool usage file:

- Completely simulate the NC program in the **Test Run** operating mode
- Completely run the NC program in the **Program Run, Full Sequence/Single Block** operating modes
- In the **Test Run** operating mode, press the **GENERATE TOOL USAGE FILE** soft key (also possible without simulation)

The tool usage file generated is in the same directory as the NC program. It contains the following information:

Column	Meaning
<b>TOKEN</b>	<ul style="list-style-type: none"> <li>■ <b>TOOL</b>: Tool usage time per tool call. The entries are listed in chronological order.</li> <li>■ <b>TTOTAL</b>: Total usage time of a tool</li> <li>■ <b>STOTAL</b>: Call of a subprogram. The entries are listed in chronological order.</li> <li>■ <b>TIMETOTAL</b>: The total machining time of the NC program is entered in the <b>WTIME</b> column. In the <b>PATH</b> column the control saves the path name of the corresponding NC program. The <b>TIME</b> column shows the sum of all <b>TIME</b> entries (feed time without rapid traverse movements). The control sets all other columns to 0</li> <li>■ <b>TOOLFILE</b>: In the <b>PATH</b> column, the control saves the path name of the tool table with which you conducted the test run. This enables the control during the actual tool usage test to detect whether you performed the test run with TOOL.T</li> </ul>
<b>TNR</b>	Tool number (-1: Tool not inserted yet)
<b>IDX</b>	Tool index
<b>NAME</b>	Tool name from the tool table
<b>TIME</b>	Tool usage time in seconds (feed time without rapid traverse movements)

Column	Meaning
WTIME	Tool-usage time in seconds (total usage time between tool changes)
RAD	<b>Tool radius R + Oversize of tool radius DR</b> from the tool table. (in mm)
BLOCK	Block number in which the <b>TOOL CALL</b> block was programmed
PATH	<ul style="list-style-type: none"> <li>■ <b>TOKEN = TOOL</b>: Path name of the active main program or subprogram</li> <li>■ <b>TOKEN = STOTAL</b>: Path name of the subprogram</li> </ul>
T	Tool number with tool index
OVRMAX	Maximum feed rate override that occurred during machining. The control enters the value 100 (%) during the test run
OVRMIN	Minimum feed rate override that occurred during machining. The control enters the value -1 during the test run
NAMEPROG	<ul style="list-style-type: none"> <li>■ 0: The tool number is programmed</li> <li>■ 1: The tool name is programmed</li> </ul>

The control saves the tool usage times in a separate file with the extension **pgmname.H.T.DEP**. This file is not visible unless the machine parameter **dependentFiles** (no. 122101) is set to **MANUAL**

There are two ways to run a tool usage test for a pallet file:

- If the cursor in the pallet file is on a pallet entry, the control runs the tool usage test for the entire pallet.
- If the cursor in the pallet file is on a program entry, the control runs the tool usage test only for the selected program.

### Using a tool usage test

Before starting a program in the **Program Run, Full Sequence/ Single Block** operating modes, you can check whether the tools being used in the selected program are available and have sufficient remaining service life. The control then compares the actual service-life values in the tool table with the nominal values from the tool usage file.

- |                       |                                                                                                       |
|-----------------------|-------------------------------------------------------------------------------------------------------|
| TOOL<br>USAGE         | ▶ Press the <b>TOOL USAGE</b> soft key                                                                |
| TOOL<br>USAGE<br>TEST | ▶ Press the <b>TOOL USAGE TEST</b> soft key                                                           |
| OK                    | ▶ The control opens the <b>Tool usage test</b> pop-up window indicating the result of the usage test. |
| OK                    | ▶ Press the <b>OK</b> soft key                                                                        |
| ENT                   | ▶ The control closes the pop-up window.                                                               |
| ENT                   | ▶ Alternative: Press the <b>ENT</b> key                                                               |

You can query the tool usage test with the **FN 18 ID975 NR1** function.

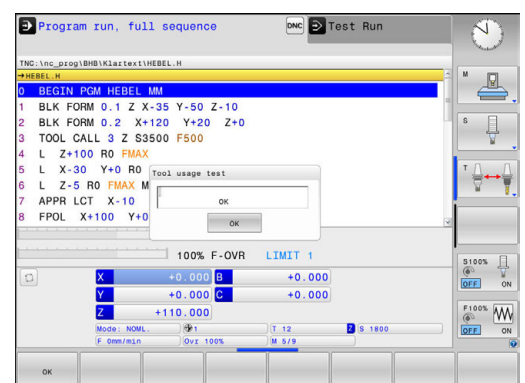

## 6.3 Tool compensation

### Introduction

The control adjusts the tool path by the compensation value for the tool length in the spindle axis. In the machining plane, it compensates the tool radius.

If you are writing the part program directly on the control, the tool radius compensation is effective only in the working plane.

The control accounts for the compensation value in up to five axes including the rotary axes.

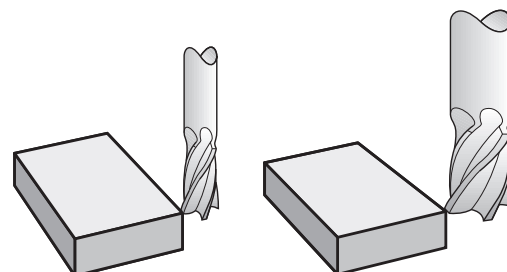

### Tool length compensation

Length compensation becomes effective automatically as soon as a tool is called. To cancel length compensation, call a tool with the length  $L=0$  (e.g. **TOOL CALL 0**).

#### NOTICE

##### Danger of collision!

The control uses the defined tool lengths for tool length compensation. Incorrect tool lengths will result in an incorrect tool length compensation. The control does not perform a length compensation and a collision check for tools with a length of **0** and after **TOOL CALL 0**. Danger of collision during subsequent tool positioning movements!

- ▶ Always define the actual tool length of a tool (not just the difference)
- ▶ Use **TOOL CALL 0** only to empty the spindle

For tool length compensation, the control takes the delta values from both the **TOOL CALL** block and the tool table into account:

Compensation value =  $L + DL_{\text{TOOL CALL}} + DL_{\text{TAB}}$  with

- L**: Tool length **L** from **TOOL DEF** block or tool table
- DL<sub>TOOL CALL</sub>**: Oversize for length **DL** in the **TOOL CALL** block
- DL<sub>TAB</sub>**: Oversize for length **DL** in the tool table



## Tool radius compensation

The block for programming a tool movement contains:

- **RL** or **RR** for radius compensation
- **R0**, if there is no radius compensation

The radius compensation is effective as soon as a tool is called and traversed with a straight-line block in the working plane with **RL** or **RR**.



The control automatically cancels radius compensation in the following cases:

- Straight-line block with **R0**
- **DEP** function for departing from the contour
- Selection a new program via **PGM MGT**

For radius compensation, the control takes the delta values from both the **TOOL CALL** block and the tool table into account:

Compensation value =  $R + DR_{\text{TOOL CALL}} + DR_{\text{TAB}}$  with

**R:** Tool radius **R** from **TOOL DEF** block or tool table

**DR<sub>TOOL CALL</sub>:** Oversize for radius **DR** in the **TOOL CALL** block

**DR<sub>TAB</sub>:** Oversize for radius **DR** in the tool table

### Contouring without radius compensation: R0

The tool center moves in the working plane along the programmed path, or to the programmed coordinates.

Applications: Drilling and boring, pre-positioning

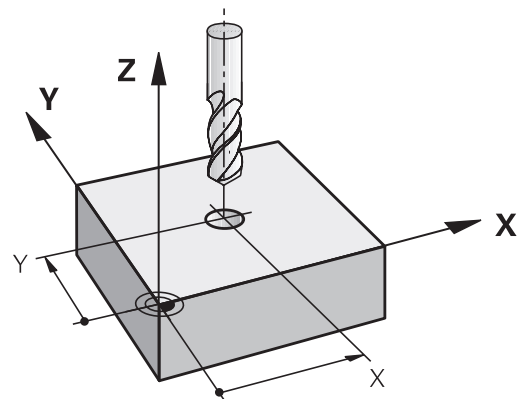
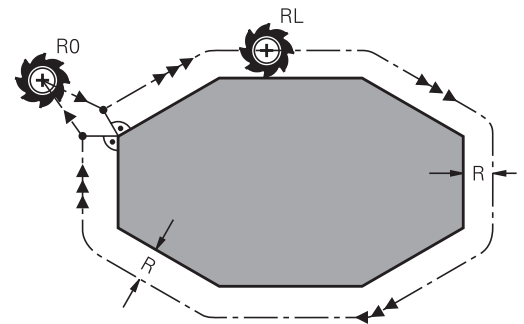

### Contouring with radius compensation: RR and RL

**RR:** The tool moves to the right of the programmed contour

**RL:** The tool moves to the left of the programmed contour

The tool center moves along the contour at a distance equal to the radius. **Right** or **left** are to be understood as based on the direction of tool movement along the workpiece contour.



Between two NC blocks with different radius compensations **RR** and **RL** you must program at least one traversing block in the working plane without radius compensation (that is, with **RO**).

The control does not put radius compensation into effect until the end of the block in which it is first programmed.

When radius compensation is activated with **RR/RL** or canceled with **RO** the control always positions the tool perpendicular to the programmed starting or end position. Position the tool at a sufficient distance from the first or last contour point to prevent the possibility of damaging the contour.

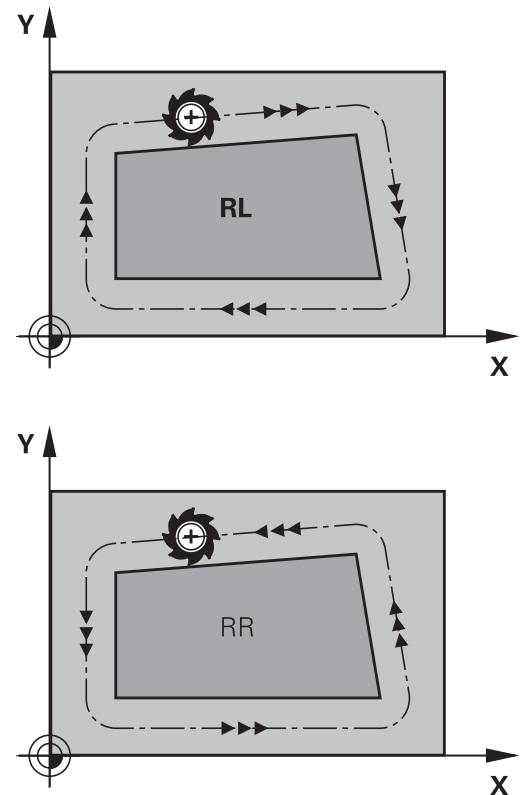

### Entering radius compensation

Radius compensation is entered in an **L** block. Enter the coordinates of the target point and confirm your entry with the **ENT** key.

#### Radius comp.: RL/RR/no comp.?

- |          |                                                                                                               |
|----------|---------------------------------------------------------------------------------------------------------------|
| RL       | ▶ Select tool movement to the left of the contour:<br>Press the <b>RL</b> soft key, or                        |
| RR       | ▶ Select tool movement to the right of the contour:<br>Press the <b>RR</b> soft key, or                       |
| ENT      | ▶ Select tool movement without radius compensation or cancel radius compensation:<br>Press the <b>ENT</b> key |
| END<br>□ | ▶ Terminate the block: Press the <b>END</b> key                                                               |

**Radius compensation: Machining corners**

- Outside corners:  
If you program radius compensation, the control moves the tool around outside corners on a transitional arc. If necessary, the control reduces the feed rate at outside corners to reduce machine stress, for example at very great changes of direction
- Inside corners:  
The control calculates the intersection of the tool center paths at inside corners under radius compensation. From this point it then starts the next contour element. This prevents damage to the workpiece at the inside corners. The permissible tool radius, therefore, is limited by the geometry of the programmed contour.

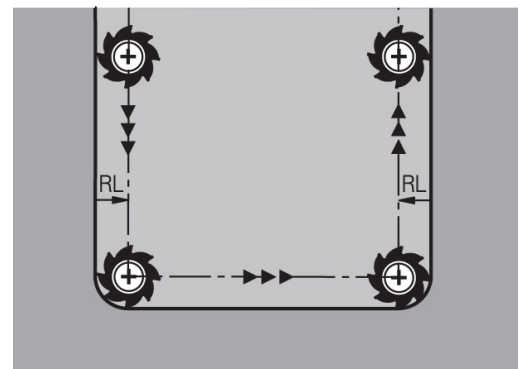
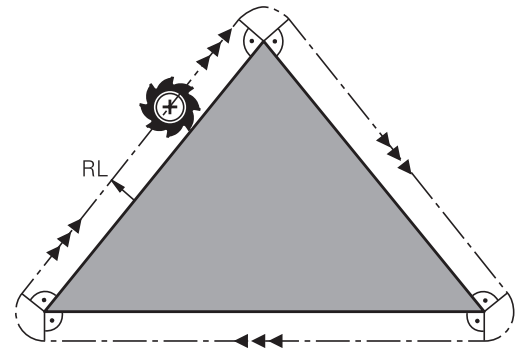
**NOTICE****Danger of collision!**

The control needs safe positions for contour approach and departure. These positions must enable the control to perform compensating movements when radius compensation is activated and deactivated. Incorrect positions can lead to contour damage. Danger of collision during machining!

- ▶ Program safe approach and departure positions at a sufficient distance from the contour
- ▶ Consider the tool radius
- ▶ Consider the approach strategy

## 6.4 Tool management (option number 93)

### Basics



Refer to your machine manual.

Tool management is a machine-dependent function, which may be partly or completely deactivated. The machine tool builder defines the exact range of functions.

In tool management, your machine manufacturer can provide a wide range of functions for tool handling. Examples:

- Display and editing of all tool data from the tool table and the touch probe table
- Easily readable and adaptable representation of the tool data in fillable forms
- Any description of the individual tool data in the new table view
- Mixed representation of data from the tool table and the pocket table
- Fast sorting of all tool data by mouse
- Use of graphic aids, e.g. color coding of tool or magazine status
- Program-specific or pallet-specific list of all available tools
- Program-specific or pallet-specific usage sequence of all tools
- Copying and pasting of all tool data pertaining to a tool
- Graphic depiction of tool type in the table view and in the detail view for a better overview of the available tool types



If you edit a tool in tool management, the selected tool is locked. If this tool is required in the NC program being used, the control shows the message: **Tool table locked**.

The screenshot shows the 'Expanded tool management' interface with a table of tool data. The table has columns for 'T', 'T', 'NAME', 'PT', 'T', 'POCI', 'MAGAZINE', 'Tool life', and 'REMAIN'. The data is as follows:

T	T	NAME	PT	T	POCI	MAGAZINE	Tool life	REMAIN
10		MILL_WPC2F05	0				Not monitored	0
1		MILL_D2_ROUGH	0		2	Main magazine	Not monitored	0
2		MILL_D4_ROUGH	0		2	Main magazine	Not monitored	0
3		MILL_D6_ROUGH	0		3	Main magazine	Not monitored	0
4		MILL_D8_ROUGH	0		4	Main magazine	Not monitored	0
5		MILL_D10_ROUGH	0		5	Main magazine	Not monitored	0
6		MILL_D12_ROUGH	0		6	Main magazine	Not monitored	0
7		MILL_D14_ROUGH	0		7	Main magazine	Not monitored	0
8		MILL_D16_ROUGH	0		8	Main magazine	Not monitored	0
9		MILL_D18_ROUGH	0		9	Main magazine	Not monitored	0
10		MILL_D20_ROUGH	0		10	Main magazine	Not monitored	0
11		MILL_D22_ROUGH	0		11	Main magazine	Not monitored	0
12		MILL_D24_ROUGH	0			Spindle	Not monitored	0
13		MILL_D26_ROUGH	0		13	Main magazine	Not monitored	0
14		MILL_D28_ROUGH	0		14	Main magazine	Not monitored	0
15		MILL_D30_ROUGH	0		15	Main magazine	Not monitored	0
16		MILL_D32_ROUGH	0		16	Main magazine	Not monitored	0
17		MILL_D34_ROUGH	0		17	Main magazine	Not monitored	0
18		MILL_D36_ROUGH	0		18	Main magazine	Not monitored	0
19		MILL_D38_ROUGH	0		19	Main magazine	Not monitored	0

The interface also includes navigation buttons at the bottom: BEGIN, END, PAGE, PAGE, MAGAZINE, FORM FOR, and END. On the right side, there are status indicators for 'S100%' and 'F100%' with 'ON' and 'OFF' buttons.

## Calling tool management



Refer to your machine manual.

The procedure for calling the tool management may differ from that described below.



- ▶ Select the tool table: Press the **TOOL TABLE** soft key



- ▶ Scroll through the soft-key row



- ▶ Press the **TOOL MANAGEMENT** soft key
- ▶ The control switches to the new table view.

T	T'	NAME	PT	T	POCI	MAGAZINE	Tool life	REMAIN
1		MILL_D22_ROUGH	0		2	Main magazine	Not monitored	0
2		MILL_D4_ROUGH	0		2	Main magazine	Not monitored	0
3		MILL_D6_ROUGH	0		3	Main magazine	Not monitored	0
4		MILL_D8_ROUGH	0		4	Main magazine	Not monitored	0
5		MILL_D10_ROUGH	0		5	Main magazine	Not monitored	0
6		MILL_D12_ROUGH	0		6	Main magazine	Not monitored	0
7		MILL_D14_ROUGH	0		7	Main magazine	Not monitored	0
8		MILL_D16_ROUGH	0		8	Main magazine	Not monitored	0
9		MILL_D18_ROUGH	0		9	Main magazine	Not monitored	0
10		MILL_D20_ROUGH	0		10	Main magazine	Not monitored	0
11		MILL_D22_ROUGH	0		11	Main magazine	Not monitored	0
12		MILL_D24_ROUGH	0			Spindle	Not monitored	0
13		MILL_D26_ROUGH	0		13	Main magazine	Not monitored	0
14		MILL_D28_ROUGH	0		14	Main magazine	Not monitored	0
15		MILL_D30_ROUGH	0		15	Main magazine	Not monitored	0
16		MILL_D32_ROUGH	0		16	Main magazine	Not monitored	0
17		MILL_D34_ROUGH	0		17	Main magazine	Not monitored	0
18		MILL_D36_ROUGH	0		18	Main magazine	Not monitored	0
19		MFL_D38_ROUGH	0		19	Main magazine	Not monitored	0

## Tool management view

In the new view, the control presents all tool information in the following four tabs:

- **Tools:** Tool specific information
- **pockets:** Pocket-specific information
- **Tooling list:** List of all tools in the NC program that is selected in the Program Run mode (only if you have already created a tool usage file)  
**Further information:** "Tool usage test", page 254
- **T usage order:** List of the sequence of all tools that are inserted in the program selected in the Program Run mode (only if you have already created a tool usage file)  
**Further information:** "Tool usage test", page 254

















If a pallet table is selected in the Program Run operating mode, the **Tooling list** and **T usage order** are calculated for the entire pallet table.

## Editing tool management

The tool management can be operated by mouse or with the keys and soft keys:

### Soft key      Editing functions for tool management

	Select the table start
	Select the table end
	Select the previous page in the table
	Select the next page in the table
	Call the form view of the marked tool. Alternative function: Press the <b>ENT</b> key
	Changing tab: <b>Tools, Pockets, Assembly list, T usage sequence</b>
	Search function: Here you can select the column to be searched and then the search term either from a list or by entering it
	Import tools
	Export tools
	Delete marked tools
	Add several lines at end of table
	Update table view
	Show the programmed tools column (if the <b>Pockets</b> tab is active)
	Define the settings: <ul style="list-style-type: none"> <li>■ <b>SORT COLUMN</b> active: Click the column header to sort the content of the column</li> <li>■ <b>SHIFT COLUMN</b> active: The column can be moved by drag and drop</li> </ul>
	Reset the manually changed settings (move columns) to the original condition

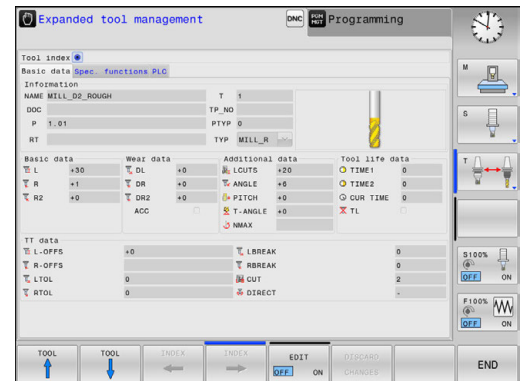



You can edit the tool data only in the form view. To activate the form view, press the **FORM FOR TOOL** soft key or the **ENT** key for the currently highlighted tool.

If you use the tool management without a mouse, then you can activate and deactivate functions with the **-/+** key.











In the tool management, use the **GOTO** key to search for the tool number or pocket number.

In addition, you can perform the following functions by mouse:

- **Sorting function:** You can sort the data in ascending or descending order (depending on the active setting of the soft key) by clicking a column of the table head.
- **Arrange columns.** You can arrange the columns in any sequence you want by clicking a column of the table head and then moving it with the mouse key pressed down. The control does not save the current column sequence when you exit the tool management (depending on the active setting of the soft key).
- **Show miscellaneous information in the form view:** The control displays tool tips when you leave the mouse pointer on an active entry field for more than a second and when you have set the **EDIT ON/OFF** soft key to **ON**

### Editing with active form view

If the form view is active, the following functions are available to you:

Soft key	Editing functions, form view
	Select the tool data of the previous tool
	Select the tool data of the next tool
	Select previous tool index (only active if indexing is enabled)
	Select the next tool index (only active if indexing is enabled)
	Open a pop-up window for selection (only available for selection fields)
	Discard all changes made since the form was called
	Add tool index
	Delete tool index
	Copy the tool data of the selected tool
	Insert the copied tool data in the selected tool



### Deleting marked tool data

Using this function you can simply delete tool data that you no longer need.

Follow the steps outlined below for deleting:

- ▶ In the tool management you use the arrow keys or mouse to mark the tool data that you wish to delete
- ▶ Press the **DELETE MARKED TOOLS** soft key
- ▶ The control shows a pop-up window listing the tool data to be deleted.
- ▶ Press the **START** soft key to start the deletion procedure
- ▶ The control shows a pop-up window with the deletion status.
- ▶ Terminate the delete process by pressing the **END** key or soft key

### NOTICE

#### Caution: Data may be lost!

The **DELETE MARKED TOOLS** function permanently deletes the tool data. The data is not automatically backed up by the control, e.g. to a recycle bin, before being deleted. The data is irreversibly deleted by this function.



















- ▶ Regularly back up important data to external drives









The tool data of tools still stored in the pocket table cannot be deleted. The tools must be removed from the magazine first.

## Available tool types

The tool management displays the various tool types with an icon. The following tool types are available:

Icon	Tool type	Tool type number
	Undefined,****	99
	Milling cutter,MILL	0
	Drill,DRILL	1
	Tap,TAP	2
	Center drill,CENT	4
	Turning Tool,TURN	29
	Touch probe,TCHP	21
	Ream,REAM	3
	Countersink,CSINK	5
	Piloted counterbore(TSINK),TSINK	6
	Boring tool,BOR	7
	Back boring tool,BCKBOR	8
	Thread mill,GF	15
	Thread mill w/ countersink,GSF	16
	Thread mill w/ single thread,EP	17
	Thread mill w/ indxbl insert,WSP	18
	Thread milling drill,BGF	19
	Circular thread mill,ZBGF	20

Icon	Tool type	Tool type number
	Roughing cutter (MILL_R),MILL_R	9
	Finishing cutter (MILL_F),MILL_F	10
	Rough/finish cutter,MILL_RF	11
	Floor finisher(MILL_FD),MILL_FD	12
	Side finisher (MILL_FS),MILL_FS	13
	Face milling cutter,MILL_FACE	14

## Importing and exporting tool data

### Importing tool data



Refer to your machine manual.

The machine tool builder can define update rules that make it possible, for example, to automatically remove umlauts from tables and NC programs.

Using this function you can simply import tool data that you have measured externally on a presetting device, for example. The file to be imported must have the CSV format (comma separated value). The **CSV** file format describes the structure of a text file for exchanging simply structured data. Accordingly, the import file must have the following structure:

- **Row 1:** In the first line you define the column names in which the data defined in the subsequent lines is to be placed. The column names are separated with a comma.
- **Other lines:** All the other lines contain the data that you wish to import into the tool table. The order of the data must match the order of the column names in Line 1. The data is separated by commas, decimal numbers are to be defined with a decimal point.

Follow the steps outlined below for importing:

- ▶ Copy the tool table to be imported to the **TNC:\system\tooltab** directory on the hard disk of the control
- ▶ Start expanded tool management
- ▶ Press the **TOOL IMPORT** soft key in the tool management
- ▶ The control shows a pop-up window with the CSV files that are saved in the **TNC:\system\tooltab** directory
- ▶ Use the arrow keys or mouse to select the file to be imported and confirm with the **ENT** key
- ▶ The control shows a pop-up window with the content of the CSV file
- ▶ Start the import procedure with the **EXECUTE** soft key.



- The CSV file to be imported must be stored in the **TNC:\system\tooltab** directory.
- If you import the tool data of existing tools (whose numbers are in the pocket table) the control issues an error message. You can then decide whether to skip this data record or insert a new tool. The control inserts a new tool into the first empty line of the tool table.
- If the imported CSV file contains unknown table columns, the control displays a message during import. An additional note informs you that the data will not be transferred.
- Make sure that the column designations have been specified correctly.  
**Further information:** "Entering tool data into the table", page 234
- You can import any tool data, the associated data record does not have to contain all the columns (or data) of the tool table.
- The column names can be in any order, the data must be defined in the corresponding order.

### Example

T,L,R,DL,DR	Line 1 with column names
4,125.995,7.995,0,0	Line 2 with tool data
9,25.06,12.01,0,0	Line 3 with tool data
28,196.981,35,0,0	Line 4 with tool data

### Exporting tool data

Using this function you can simply export tool data to read it into the tool database of your CAM system, for example. The control stores the exported file in the CSV format (**c**omma **s**eparated **v**alue). The **CSV** file format describes the structure of a text file for exchanging simply structured data. The export file has the following structure:

- **Line 1:** In the first line the control stores the column names of all the relevant tool data to be defined. The column names are separated from each other by commas.
- **Further lines:** All the other lines contain the data of the tools that you have exported. The order of the data matches the order of the column names in Line 1. The data is separated by commas, the control outputs decimal numbers with a decimal point.

Follow the steps outlined below for exporting:

- ▶ In the tool management you use the arrow keys or mouse to mark the tool data that you wish to export
- ▶ Press the **EXPORT TOOL** soft key
- > The control shows a pop-up window
- ▶ Enter a name for the CSV file and confirm it with the **ENT** key
- ▶ Start the export procedure with the **EXECUTE** soft key
- > The control shows a pop-up window with the status of the export process
- ▶ Terminate the export process by pressing the **END** key or soft key



By default the control stores the exported CSV file in the **TNC:\system\tooltab** directory.

# 7

**Programming  
Contours**

## 7.1 Tool movements

### Path functions

A workpiece contour is usually composed of several contour elements such as straight lines and circular arcs. With the path functions, you can program the tool movements for **straight lines** and **circular arcs**.

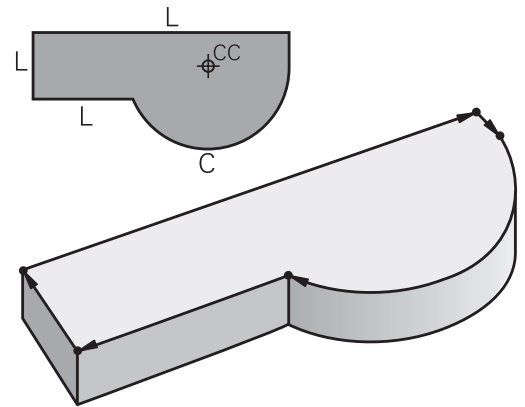

### FK free contour programming (option 19)

If a production drawing is not dimensioned for NC and the dimensions given are not sufficient for creating a part program, you can program the workpiece contour with the FK free contour programming. The control calculates the missing data.

With FK programming, you also program tool movements for **straight lines** and **circular arcs**.

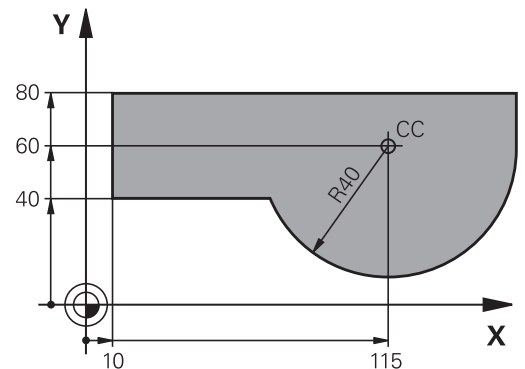

### Miscellaneous functions M

With the control's miscellaneous functions you can affect

- the program run, e.g., a program interruption
- the machine functions, such as switching spindle rotation and coolant supply on and off
- the path behavior of the tool



## Subprograms and program section repeats

If a machining sequence occurs several times in a program, you can save time and reduce the chance of programming errors by entering the sequence once and then defining it as a subprogram or program section repeat. If you wish to execute a specific program section only under certain conditions, you also define this machining sequence as a subprogram. In addition, you can have a part program call a separate program for execution.

**Further information:** "Subprograms and Program Section Repeats", page 345

## Programming with Q parameters

Instead of programming numerical values in a machining program, you enter markers called Q parameters. You assign the values to the Q parameters separately with the Q parameter functions. You can use the Q parameters for programming mathematical functions that control program execution or describe a contour.

In addition, programming with Q parameters enables you to measure with the 3-D touch probe during the program run.

**Further information:** "Programming Q Parameters", page 365

## 7.2 Fundamentals of path functions

### Programming tool movements for workpiece machining

You create a part program by programming the path functions for the individual contour elements in sequence. You do this by entering the coordinates of the end points of the contour elements given in the production drawing. The control calculates the actual path of the tool from these coordinates, and from the tool data and radius compensation.

The control moves all machine axes programmed in the NC block of a path function simultaneously.

#### Movement parallel to the machine axes

If the NC block contains one coordinate, the control moves the tool parallel to the programmed machine axis.

Depending on the individual machine tool, the part program is executed by movement of either the tool or the machine table on which the workpiece is clamped. Path contours are programmed as if the tool were moving.

#### Example

```
50 L X+100
```

**50**            Block number  
**L**             Path function **straight line**  
**X+100**        Coordinate of the end point

The tool retains the Y and Z coordinates and moves to the position X=100.

#### Movement in the main planes

If the NC block contains two coordinates, the control moves the tool in the programmed plane.

#### Example

```
L X+70 Y+50
```

The tool retains the Z coordinate and moves on the XY plane to the position X=70, Y=50.

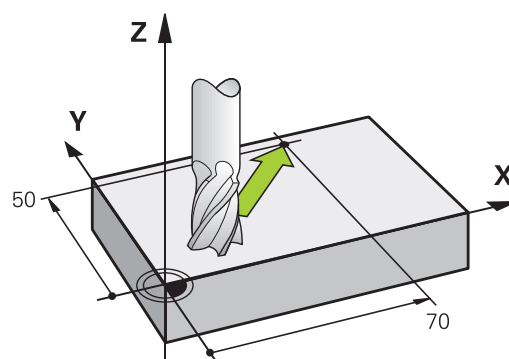
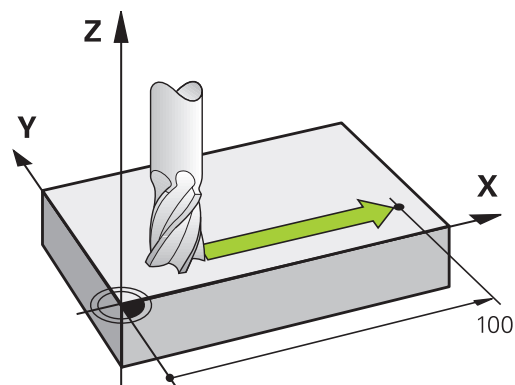

**Three-dimensional movement**

If the NC block contains three coordinates, the control moves the tool spatially to the programmed position.

**Example**

```
L X+80 Y+0 Z-10
```

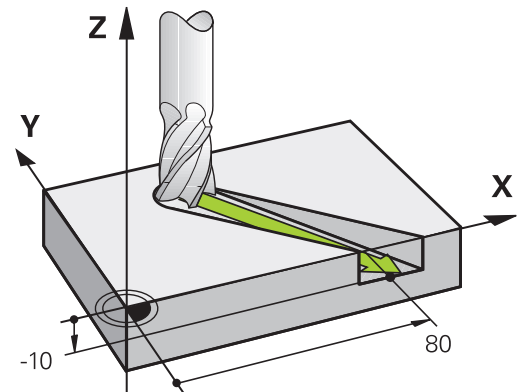

**Circles and circular arcs**

The control moves two machine axes simultaneously on a circular path relative to the workpiece. You can define a circular movement by entering the circle center **CC**.

When you program a circle, the control assigns it to one of the main planes. This plane is defined automatically when you set the spindle axis during a **TOOL CALL**:

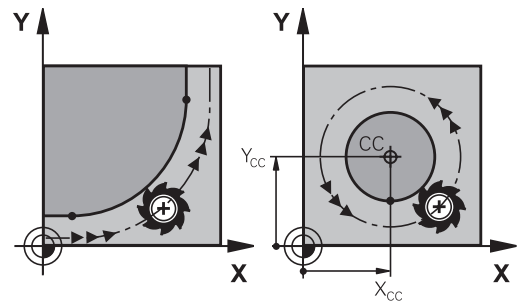

Spindle axis	Main plane
Z	XY, also UV, XV, UY
Y	ZX, also WU, ZU, WX
X	YZ, also VW, YW, VZ



You can program circles that do not lie parallel to a main plane by using the function for **Tilt working plane** or with Q parameters.

**Further information:** "The PLANE function: Tilting the working plane (option 8)", page 535

**Further information:** "Principle and overview of functions", page 366

**Direction of rotation DR for circular movements**

When a circular path has no tangential transition to another contour element, enter the direction of rotation as follows:

Clockwise direction of rotation: **DR-**

Counterclockwise direction of rotation: **DR+**

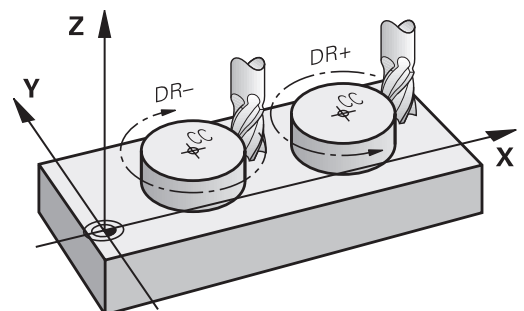

### Radius compensation

The radius compensation must be in the block in which you move to the first contour element. You cannot activate radius compensation in a circle block. It must be activated beforehand in a straight-line block.

**Further information:** "Path contours Cartesian coordinates", page 288

**Further information:** "Approaching and departing a contour", page 278

### Pre-positioning

#### NOTICE

##### Danger of collision!

The control does not automatically check whether collisions can occur between the tool and the workpiece. Incorrect pre-positioning can also lead to contour damage. There is danger of collision during the approach movement!

- ▶ Program a suitable pre-position
- ▶ Check the sequence and contour with the aid of the graphic simulation

### Creating the NC blocks with the path function keys

The gray path function keys initiate the dialog. The control asks you successively for all the necessary information and inserts the NC block into the part program.

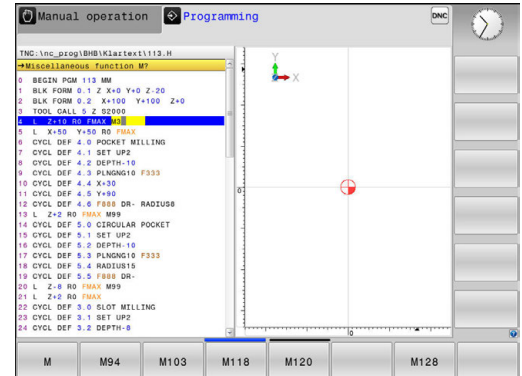

**Example – programming a straight line**

- ▶ Initiate the programming dialog, e.g. for a straight line

**COORDINATES?**

- ▶ Enter the coordinates of the straight-line end point, e.g. -20 in X

**COORDINATES?**

- ▶ Enter the coordinates of the straight-line end point, e.g. 30 in Y, and confirm with the **ENT** key

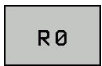
**Radius comp.: RL/RR/no comp.?**

- ▶ Select the radius compensation (here, press the **R0** soft key—the tool moves without compensation)

**Feed rate F=? / F MAX = ENT**

- ▶ Enter **100** (feed rate e.g. 100 mm/min; for programming in inches: an input of 100 corresponds to a feed rate of 10 inches/min) and confirm your entry with the **ENT** key, or



- ▶ Move at rapid traverse: Press the **FMAX** soft key, or



- ▶ Traverse with the feed rate defined in the **TOOL CALL** block: Press the **F AUTO** soft key.

**MISCELLANEOUS FUNCTION M?**

- ▶ Enter **3** (miscellaneous function e.g. M3) and terminate the dialog with the **END** key

**Example**

```
L X-20 Y+30 R0 FMAX M3
```

## 7.3 Approaching and departing a contour

### Starting point and end point

The tool approaches the first contour point from the starting point. The starting point must be:

- Programmed without radius compensation
- Approachable without danger of collision
- Close to the first contour point

Example in the figure on the right:

If you set the starting point in the dark gray area, the contour will be damaged when the first contour element is approached.

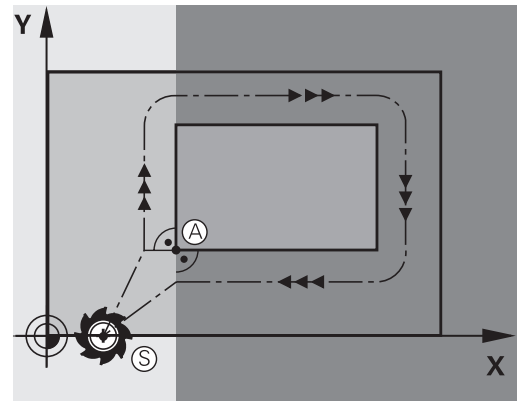

### First contour point

You need to program a radius compensation for the tool movement to the first contour point.

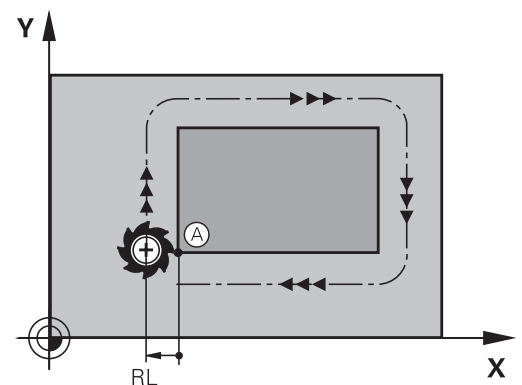

### Approaching the starting point in the spindle axis

When the starting point is approached, the tool must be moved to the working depth in the spindle axis. If danger of collision exists, approach the starting point in the spindle axis separately.

### Example

```
30 L Z-10 R0 FMAX
```

```
31 L X+20 Y+30 RL F350
```

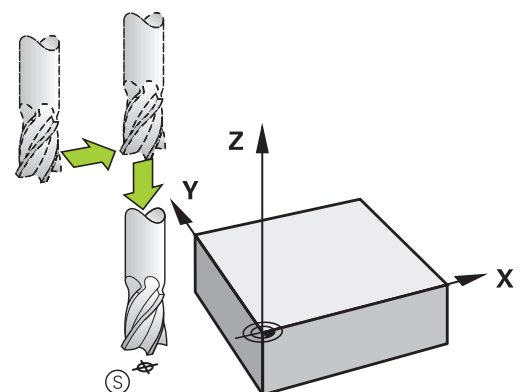

**End point**

The end point should be selected so that it is:

- Approachable without danger of collision
- Near to the last contour point
- In order to make sure the contour will not be damaged, the optimal ending point should lie on the extended tool path for machining the last contour element

Example in the figure on the right:

If you set the end point in the dark gray area, the contour will be damaged when the end point is approached.

Departing the end point in the spindle axis:

Program the departure from the end point in the spindle axis separately.

**Example**

```
50 L X+60 Y+70 R0 F700
```

```
51 L Z+250 R0 FMAX
```

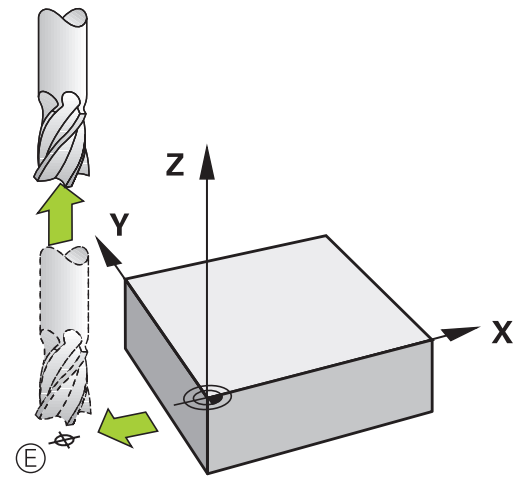
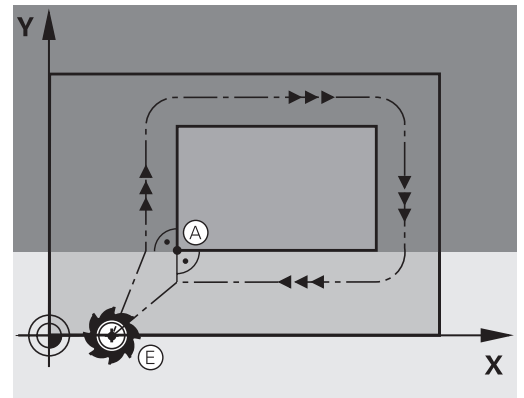

**Common starting and end points**

Do not program any radius compensation if the starting point and end point are the same.

In order to make sure the contour will not be damaged, the optimal starting point should lie between the extended tool paths for machining the first and last contour elements.





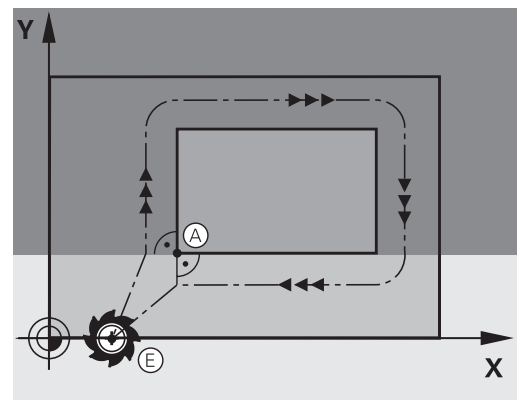



Example in the figure on the right:

If you set the end point in the dark gray area, the contour will be damaged when the contour is approached/departed.



## Overview: Types of paths for contour approach and departure

The functions for contour approach **APPR** and departure **DEP** are activated with the **APPR/DEP** key. You can then select the following path forms with the corresponding soft keys:

Approach	Departure	Function
		Straight line with tangential connection
		Straight line perpendicular to a contour point
		Circular arc with tangential connection
		Circular arc with tangential connection to the contour. Approach and departure to an auxiliary point outside the contour on a tangentially connecting line

### Approaching and departing a helix

The tool approaches and departs a helix on its extension by moving in a circular arc that connects tangentially to the contour. You program helical approach and departure with the **APPR CT** and **DEP CT** functions.

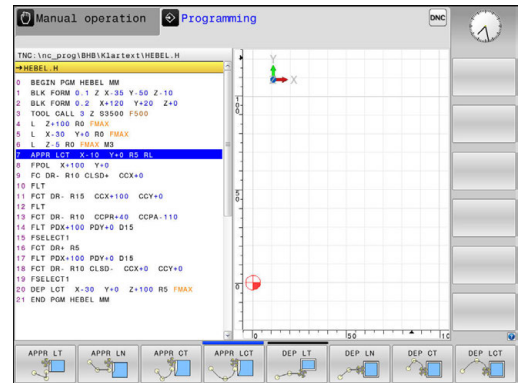



### Important positions for approach and departure

- Starting point  $P_S$   
You program this position in the block before the APPR block.  $P_S$  lies outside the contour and is approached without radius compensation (R0).
- Auxiliary point  $P_H$   
Some of the paths for approach and departure go through an auxiliary point  $P_H$  that the control calculates from your input in the APPR or DEP block. The control moves from the current position to the auxiliary point  $P_H$  at the feed rate last programmed. If you have programmed **FMAX** (positioning at rapid traverse) in the last positioning block before the approach function, the control also approaches the auxiliary point  $P_H$  at rapid traverse
- First contour point  $P_A$  and last contour point  $P_E$   
You program the first contour point  $P_A$  in the APPR block. The last contour point  $P_E$  can be programmed with any path function. If the APPR block also includes the Z coordinate, the control moves the tool simultaneously to the first contour point  $P_A$ .
- End point  $P_N$   
The position  $P_N$  lies outside of the contour and results from your input in the DEP block. If the DEP block also includes the Z coordinate, the control moves the tool simultaneously to the end point  $P_N$ .

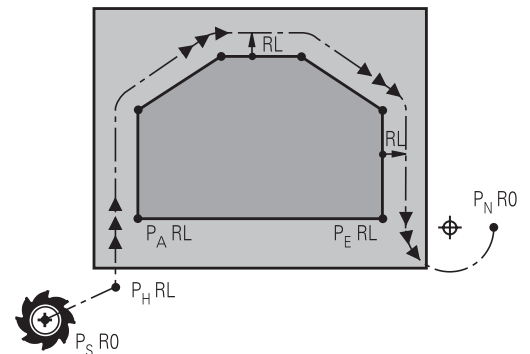

Abbreviation	Meaning
APPR	Approach
DEP	Departure
L	Line
C	Circle
T	Tangential (smooth connection)
N	Normal (perpendicular)

### NOTICE

#### Danger of collision!

The control does not automatically check whether collisions can occur between the tool and the workpiece. Incorrect pre-positioning and incorrect auxiliary points  $P_H$  can also lead to contour damage. There is danger of collision during the approach movement!

- ▶ Program a suitable pre-position
- ▶ Check the auxiliary point  $P_H$ , the sequence and the contour with the aid of the graphic simulation



With the **APPR LT**, **APPR LN** and **APPR CT** functions, the control moves the tool to the auxiliary point  $P_H$  at the last programmed feed rate (which can also be **FMAX**). With the **APPR LCT** function, the control moves to the auxiliary point  $P_H$  at the feed rate programmed with the APPR block. If no feed rate is programmed yet before the approach block, the control generates an error message.

### Polar coordinates

You can also program the contour points for the following approach/ departure functions over polar coordinates:

- APPR LT becomes APPR PLT
- APPR LN becomes APPR PLN
- APPR CT becomes APPR PCT
- APPR LCT becomes APPR PLCT
- DEP LCT becomes DEP PLCT

Select an approach or departure function with the soft key, then press the orange **P** key.

### Radius compensation

The tool radius compensation is programmed together with the first contour point  $P_A$  in the APPR block. The DEP blocks automatically discard the tool radius compensation.



If you program **APPR LN** or **APPR CT** with **RO**, the control stops the machining/simulation with an error message. This method of function differs from the iTNC 530 control!

### Approaching on a straight line with tangential connection: APPR LT

The tool moves on a straight line from the starting point  $P_S$  to an auxiliary point  $P_H$ . It then moves to the first contour point  $P_A$  on a straight line that connects tangentially to the contour. The auxiliary point  $P_H$  is separated from the first contour point  $P_A$  by the distance **LEN**.

- ▶ Use any path function to approach the starting point  $P_S$
- ▶ Initiate the dialog with the **APPR DEP** key and **APPR LT** soft key



- ▶ Coordinates of the first contour point  $P_A$
- ▶ **LEN**: Distance from the auxiliary point  $P_H$  to the first contour point  $P_A$
- ▶ Radius compensation **RR/RL** for machining

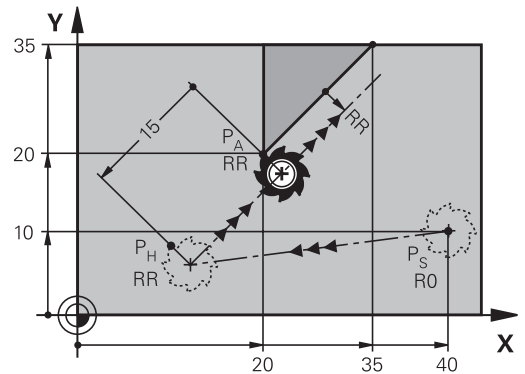

#### Example

7 L X+40 Y+10 R0 FMAX M3	$P_S$ without radius compensation
8 APPR LT X+20 Y+20 Z-10 LEN15 RR F100	$P_A$ with radius comp. RR, distance $P_H$ to $P_A$ : LEN=15
9 L X+35 Y+35	End point of the first contour element
10 L ...	Next contour element

### Approaching on a straight line perpendicular to the first contour point: APPR LN

- ▶ Use any path function to approach the starting point  $P_S$ .
- ▶ Initiate the dialog with the **APPR DEP** key and **APPR LN** soft key:



- ▶ Coordinates of the first contour point  $P_A$
- ▶ Length: Distance to the auxiliary point  $P_H$ . Always enter **LEN** as a positive value
- ▶ Radius compensation **RR/RL** for machining

#### Example

7 L X+40 Y+10 R0 FMAX M3	Approach $P_S$ without radius compensation
8 APPR LN X+10 Y+20 Z-10 LEN15 RR F100	$P_A$ with radius comp. RR
9 L X+20 Y+35	End point of the first contour element
10 L ...	Next contour element

## Approaching on a circular path with tangential connection: APPR CT

The tool moves on a straight line from the starting point  $P_S$  to an auxiliary point  $P_H$ . It then moves from  $P_H$  to the first contour point  $P_A$  following a circular arc that is tangential to the first contour element.

The arc from  $P_H$  to  $P_A$  is determined through the radius  $R$  and the center angle **CCA**. The direction of rotation of the circular arc is automatically derived from the tool path for the first contour element.

- ▶ Use any path function to approach the starting point  $P_S$ .
- ▶ Initiate the dialog with the **APPR DEP** key and **APPR CT** soft key

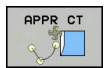

- ▶ Coordinates of the first contour point  $P_A$
- ▶ Radius  $R$  of the circular arc
  - If the tool should approach the workpiece in the direction defined by the radius compensation: Enter  $R$  as a positive value
  - If the tool should approach the workpiece opposite to the radius compensation: Enter  $R$  as a negative value.
- ▶ Center angle **CCA** of the arc
  - CCA can be entered only as a positive value.
  - Maximum input value  $360^\circ$
- ▶ Radius compensation **RR/RL** for machining

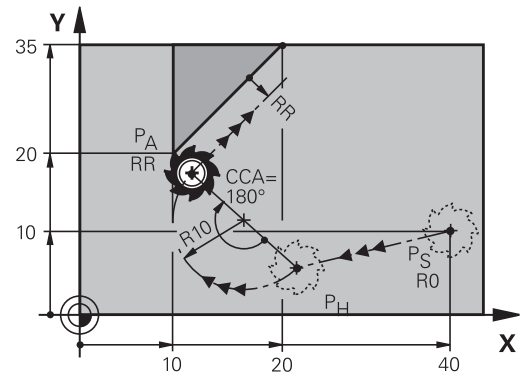

### Example

7 L X+40 Y+10 R0 FMAX M3	Approach $P_S$ without radius compensation
8 APPR CT X+10 Y+20 Z-10 CCA180 R+10 RR F100	$P_A$ with radius compensation $RR$ , radius $R=10$
9 L X+20 Y+35	End point of the first contour element
10 L ...	Next contour element

### Approaching on a circular path with tangential connection from a straight line to the contour: APPR LCT

The tool moves on a straight line from the starting point  $P_S$  to an auxiliary point  $P_H$ . It then moves to the first contour point  $P_A$  on a circular arc. The feed rate programmed in the APPR block is effective for the entire path that the control traversed in the approach block (path  $P_S$  to  $P_A$ ).

If you have programmed the coordinates of all three principal axes X, Y and Z in the approach block, the control moves the tool from the position defined before the APPR block to the auxiliary point  $P_H$  on all three axes simultaneously. Then the connect goes from  $P_H$  to  $P_A$  only on the working plane.

The arc is connected tangentially both to the line  $P_S - P_H$  as well as to the first contour element. Once these lines are known, the radius then suffices to completely define the tool path.

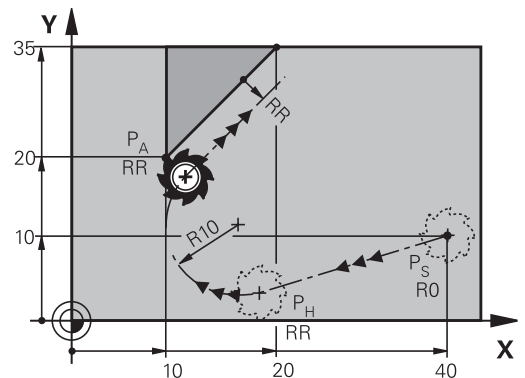

- ▶ Use any path function to approach the starting point  $P_S$ .
- ▶ Initiate the dialog with the **APPR DEP** key and **APPR LCT** soft key:

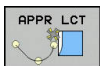

- ▶ Coordinates of the first contour point  $P_A$
- ▶ Radius R of the circular arc. Enter R as a positive value
- ▶ Radius compensation **RR/RL** for machining

#### Example

7 L X+40 Y+10 R0 FMAX M3	Approach PS without radius compensation
8 APPR LCT X+10 Y+20 Z-10 R10 RR F100	PA with radius compensation RR, radius R=10
9 L X+20 Y+35	End point of the first contour element
10 L ...	Next contour element

### Departing in a straight line with tangential connection: DEP LT

The tool moves on a straight line from the last contour point  $P_E$  to the end point  $P_N$ . The line lies on the extension of the last contour element.  $P_N$  is separated from  $P_E$  by the distance **LEN**.

- ▶ Program the last contour element with the end point  $P_E$  and radius compensation
- ▶ Initiate the dialog with the **APPR DEP** key and **DEP LT** soft key



- ▶ **LEN**: Enter the distance from the last contour element  $P_E$  to the end point  $P_N$ .

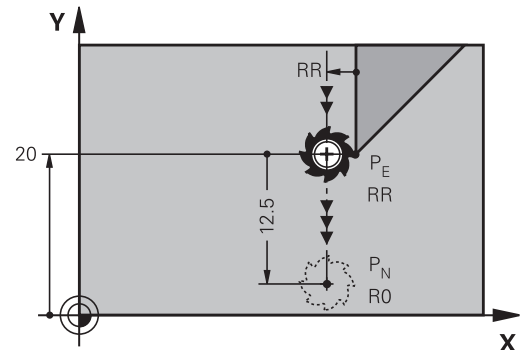

#### Example

23 L Y+20 RR F100	Last contour element: PE with radius compensation
24 DEP LT LEN12.5 F100	Depart contour by LEN=12.5 mm
25 L Z+100 FMAX M2	Retract in Z, return to block 1, end program

### Departing in a straight line perpendicular to the last contour point: DEP LN

The tool moves on a straight line from the last contour point  $P_E$  to the end point  $P_N$ . The line departs on a perpendicular path from the last contour point  $P_E$ .  $P_N$  is separated from  $P_E$  by the distance **LEN** plus the tool radius.

- ▶ Program the last contour element with the end point  $P_E$  and radius compensation
- ▶ Initiate the dialog with the **APPR DEP** key and **DEP LN** soft key



- ▶ **LEN**: Enter the distance from the last contour element to  $P_N$ . Important: Enter a positive value in **LEN**

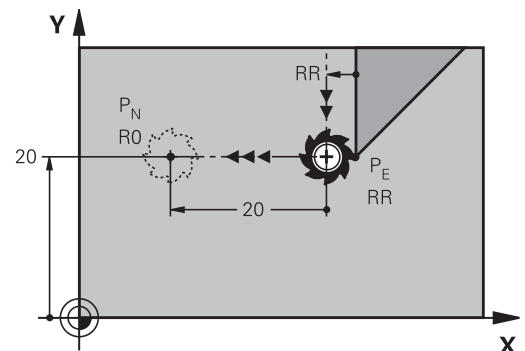

#### Example

23 L Y+20 RR F100	Last contour element: PE with radius compensation
24 DEP LN LEN+20 F100	Depart perpendicular to contour by LEN=20 mm
25 L Z+100 FMAX M2	Retract in Z, return to block 1, end program

### Departing on a circular path with tangential connection: DEP CT

The tool moves on a circular arc from the last contour point  $P_E$  to the end point  $P_N$ . The circular arc connects tangentially to the last contour element.

- ▶ Program the last contour element with the end point  $P_E$  and radius compensation
- ▶ Initiate the dialog with the **APPR DEP** key and **DEP CT** soft key



- ▶ Center angle **CCA** of the arc
- ▶ Radius **R** of the circular arc
  - If the tool should depart the workpiece in the direction opposite to the radius compensation: Enter **R** as a positive value.
  - If the tool should depart the workpiece in the direction **opposite** to the radius compensation: Enter **R** as a negative value.

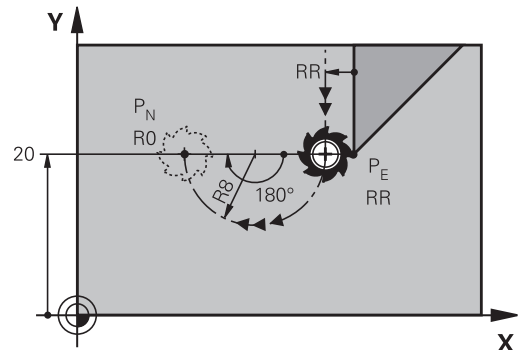

#### Example

23 L Y+20 RR F100	Last contour element: PE with radius compensation
24 DEP CT CCA 180 R+8 F100	Center angle=180°, arc radius=8 mm
25 L Z+100 FMAX M2	Retract in Z, return to block 1, end program

### Departing on a circular arc tangentially connecting the contour and a straight line: DEP LCT

The tool moves on a circular arc from the last contour point  $P_S$  to an auxiliary point  $P_H$ . It then moves on a straight line to the end point  $P_N$ . The arc is tangentially connected both to the last contour element and to the line from  $P_H$  to  $P_N$ . Once these lines are known, the radius **R** suffices to unambiguously define the tool path.

- ▶ Program the last contour element with the end point  $P_E$  and radius compensation
- ▶ Initiate the dialog with the **APPR/DEP** key and **DEP LCT** soft key



- ▶ Enter the coordinates of the end point  $P_N$
- ▶ Radius **R** of the circular arc. Enter **R** as a positive value

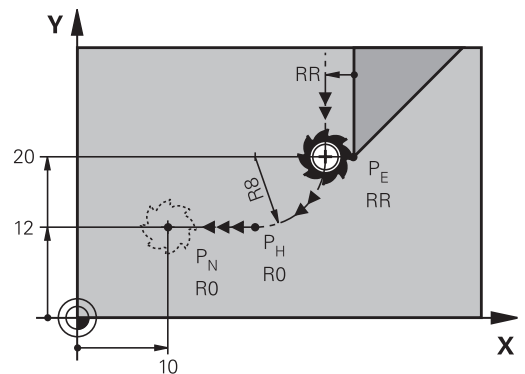









#### Example

23 L Y+20 RR F100	Last contour element: PE with radius compensation
24 DEP LCT X+10 Y+12 R+8 F100	Coordinates PN, arc radius=8 mm
25 L Z+100 FMAX M2	Retract in Z, return to block 1, end program

## 7.4 Path contours — Cartesian coordinates

### Overview of path functions

Path function key	Function	Tool movement	Required input	Page
	Straight line <b>L</b>	Straight line	Coordinates of the end point of the straight line	289
	Chamfer: <b>CHF</b>	Chamfer between two straight lines	Chamfer side length	290
	Circle center <b>CC</b>	None	Coordinates of the circle center or pole	292
	Circular arc <b>C</b>	Circular arc around a circle center CC to an arc end point	Coordinates of the arc end point, direction of rotation	293
	Circular arc <b>CR</b>	Circular arc with a certain radius	Coordinates of the arc end point, arc radius, direction of rotation	294
	Circular arc <b>CT</b>	Circular arc with tangential connection to the preceding and subsequent contour elements	Coordinates of the arc end point	296
	Corner rounding <b>RND</b>	Circular arc with tangential connection to the preceding and subsequent contour elements	Rounding radius R	291
	<b>FK</b> free contour programming	Straight line or circular path with any connection to the preceding contour element	"Path contours – FK free contour programming (option 19)", page 307	310



## Straight line L

The control moves the tool in a straight line from its current position to the straight-line end point. The starting point is the end point of the preceding block.



- ▶ Press the **L** key to open a program block for a linear movement
- ▶ **Coordinates** of the end point of the straight line, if necessary
- ▶ **Radius compensation RL/RR/R0**
- ▶ **Feed rate F**
- ▶ **Miscellaneous function M**

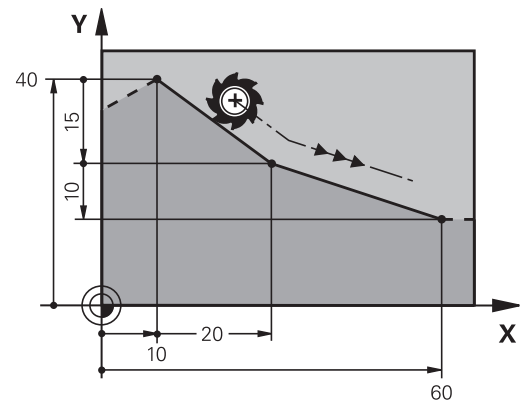

### Example

```
7 L X+10 Y+40 RL F200 M3
```

```
8 L IX+20 IY-15
```

```
9 L X+60 IY-10
```

### Actual position capture

You can also generate a straight-line block (**L** block) by using the **actual position capture** key:

- ▶ In the Manual Operation mode, move the tool to the position you want to capture
- ▶ Switch the screen display to programming.
- ▶ Select the NC block after which you want to insert the straight line block



- ▶ Press the **actual position capture** key
- ▶ The control generates a straight-line block with the actual position coordinates.

## Inserting a chamfer between two straight lines

The chamfer enables you to cut off corners at the intersection of two straight lines.

- The line blocks before and after the **CHF** block must be in the same working plane as the chamfer.
- The radius compensation before and after the **CHF** block must be the same
- The chamfer must be machinable with the current tool



- ▶ **Chamfer side length:** Length of the chamfer, and if necessary:
- ▶ **Feed rate F** (effective only in **CHF** block)

### Example

```
7 L X+0 Y+30 RL F300 M3
```

```
8 L X+40 IY+5
```

```
9 CHF 12 F250
```

```
10 L IX+5 Y+0
```

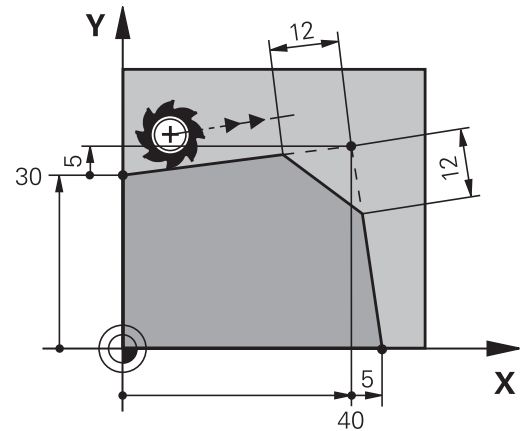

You cannot start a contour with a **CHF** block.

A chamfer is possible only in the working plane.

The corner point is cut off by the chamfer and is not part of the contour.

A feed rate programmed in the **CHF** block is effective only in that CHF block. After the **CHF** block, the previous feed rate becomes effective again.

## Rounded corners RND

The **RND** function rounds off contour corners.

The tool moves on an arc that is tangentially connected to both the preceding and subsequent contour elements.

The rounding arc must be machinable with the called tool.



- ▶ **Rounding radius:** Enter the radius, and if necessary:
- ▶ **Feed F** (effective only in the **RND** block)

### Example

```
5 L X+10 Y+40 RL F300 M3
```

```
6 L X+40 Y+25
```

```
7 RND R5 F100
```

```
8 L X+10 Y+5
```

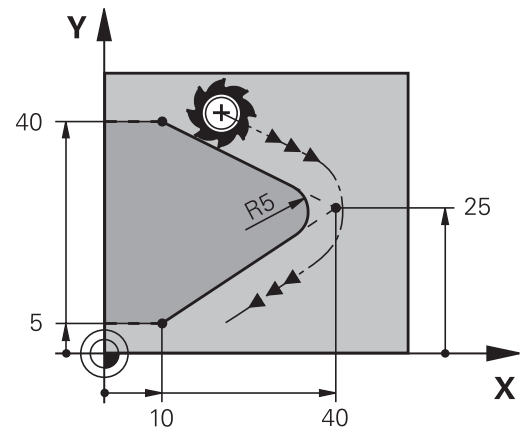

In the preceding and subsequent contour elements, both coordinates must lie in the plane of the rounding arc. If you machine the contour without tool-radius compensation, you must program both coordinates in the plane.

The corner point is cut off by the rounding arc and is not part of the contour.

A feed rate programmed in the **RND** block is effective only in that **RND** block. After the **RND** block, the previous feed rate becomes effective again.

You can also use an **RND** block for a tangential contour approach.

## Circle center CC

You can define a circle center for circles that you have programmed with the C key (circular path C) . This is done in the following ways:

- Entering the Cartesian coordinates of the circle center in the working plane, or
- Using the circle center defined in an earlier block, or
- Capturing the coordinates with the **Actual-position capture** key



- ▶ Enter coordinates for the circle center or, if you want to use the last programmed position, enter no coordinates

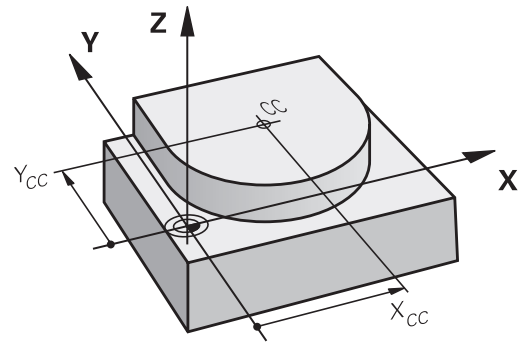

### Example

```
5 CC X+25 Y+25
```

or

```
10 L X+25 Y+25
```

```
11 CC
```

The program lines 10 and 11 do not refer to the illustration.

### Validity

The circle center definition remains in effect until a new circle center is programmed.

### Entering the circle center incrementally

If you enter the circle center with incremental coordinates, you have programmed it relative to the last programmed position of the tool.



The only effect of **CC** is to define a position as circle center: The tool does not move to this position.  
The circle center is also the pole for polar coordinates.

### Circular path C around circle center CC

Before programming a circular arc, you must first enter the circle center **CC**. The last programmed tool position will be the starting point of the arc.

- ▶ Move the tool to the circle starting point

 ▶ Enter the **coordinates** of the circle center

 ▶ Enter the **coordinates** of the arc end point, and if necessary:

- ▶ **Direction of rotation DR**
- ▶ **Feed F**
- ▶ **Miscellaneous function M**

**i** The control normally makes circular movements in the active working plane. However, you can also program circular arcs that do not lie in the active working plane. By simultaneously rotating these circular movements you can create spatial arcs (arcs in three axes), e.g. **C Z... X... DR+** (with tool axis Z).

#### Example

5 CC X+25 Y+25

6 L X+45 Y+25 RR F200 M3

7 C X+45 Y+25 DR+

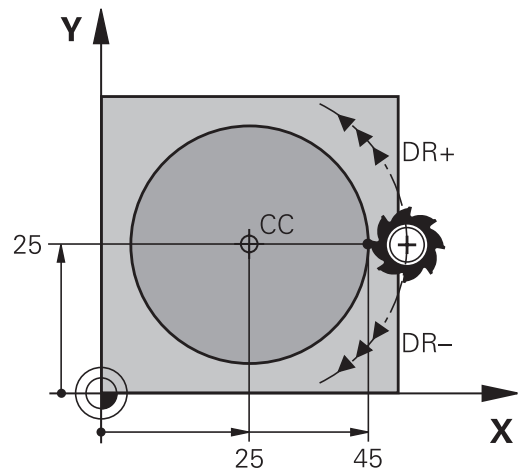
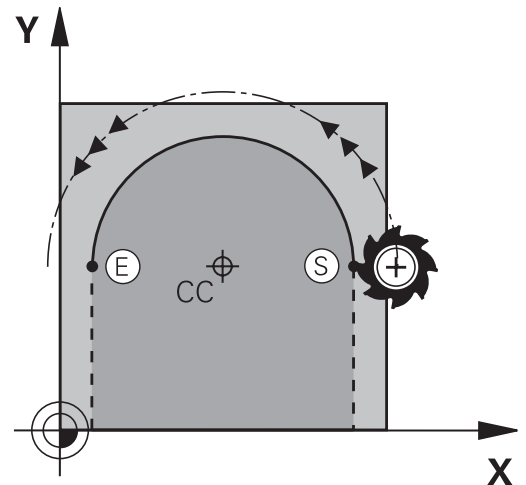

#### Full circle

For the end point, enter the same point that you used for the starting point.

**i** The starting and end points of the arc must lie on the circle.  
 The maximum value for input tolerance is 0.016 mm. Set the input tolerance in the machine parameter **circleDeviation** (no. 200901).  
 Smallest possible circle that the control can traverse: 0.016 mm.

## Circle CR with defined radius

The tool moves on a circular path with the radius  $R$ .



- ▶ **Coordinates** of the arc end point
- ▶ **Radius  $R$**  (the algebraic sign determines the size of the arc)
- ▶ **Direction of rotation  $DR$**  Note: The algebraic sign determines whether the arc is concave or convex.
- ▶ **Miscellaneous function  $M$**
- ▶ **Feed  $F$**

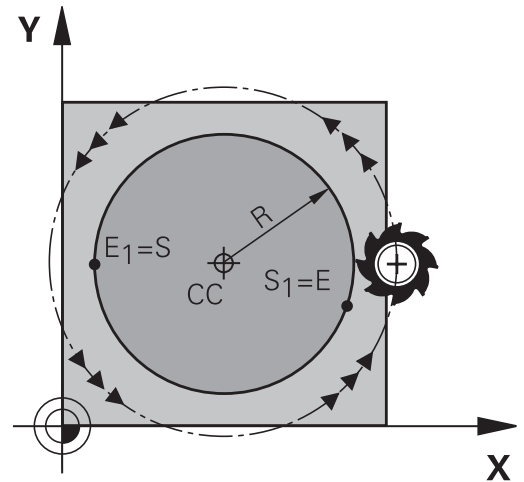

### Full circle

For a full circle, program two blocks in succession:

The end point of the first semicircle is the starting point of the second. The end point of the second semicircle is the starting point of the first.

### Central angle CCA and arc radius R

The starting and end points on the contour can be connected with four arcs of the same radius:

Smaller arc:  $CCA < 180^\circ$

Enter the radius with a positive sign  $R > 0$

Larger arc:  $CCA > 180^\circ$

Enter the radius with a negative sign  $R < 0$

The direction of rotation determines whether the arc is curving outward (convex) or curving inward (concave):

Convex: Direction of rotation **DR-** (with radius compensation **RL**)

Concave: Direction of rotation **DR+** (with radius compensation **RL**)

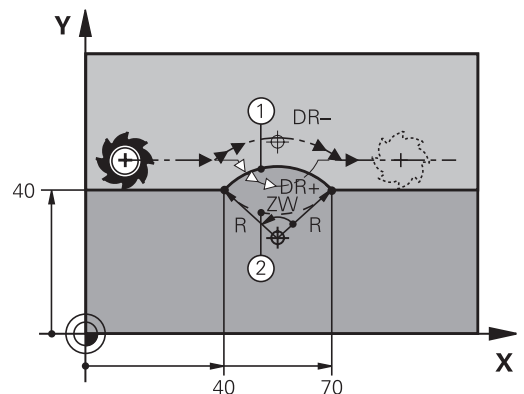

The distance from the starting and end points of the arc diameter cannot be greater than the diameter of the arc.

The maximum radius is 99.9999 m.

You can also enter rotary axes A, B and C.

The control normally makes circular movements in the active working plane. However, you can also program circular arcs that do not lie in the active working plane. By simultaneously rotating these circular movements you can create spatial arcs (arcs in three axes).

**Example**

10 L X+40 Y+40 RL F200 M3

11 CR X+70 Y+40 R+20 DR- (arc 1)

or

11 CR X+70 Y+40 R+20 DR+ (arc 2)

or

11 CR X+70 Y+40 R-20 DR- (arc 3)

or

11 CR X+70 Y+40 R-20 DR+ (arc 4)

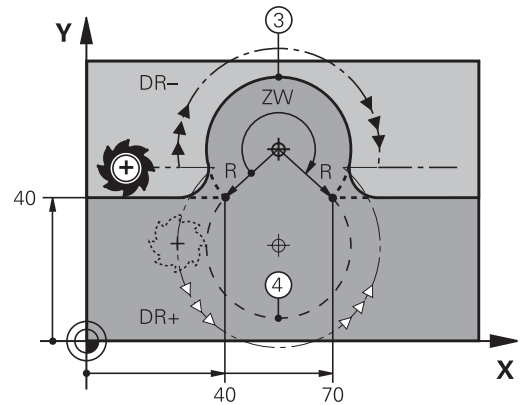

## Circle CT with tangential connection

The tool moves on an arc that starts tangentially to the previously programmed contour element.

A transition between two contour elements is called tangential when there is no kink or corner at the intersection between the two contours—the transition is smooth.

The contour element to which the tangential arc connects must be programmed immediately before the **CT** block. This requires at least two positioning blocks.



- ▶ **Coordinates** of the arc end point, and if necessary:
- ▶ **Feed F**
- ▶ **Miscellaneous function M**

### Example

```
7 L X+0 Y+25 RL F300 M3
```

```
8 L X+25 Y+30
```

```
9 CT X+45 Y+20
```

```
10 L Y+0
```



A tangential arc is a two-dimensional operation: the coordinates in the **CT** block and in the contour element preceding it must be in the same plane of the arc!

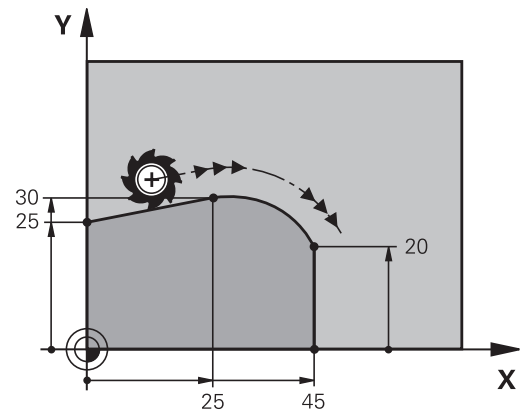



### Example: Linear movements and chamfers with Cartesian coordinates

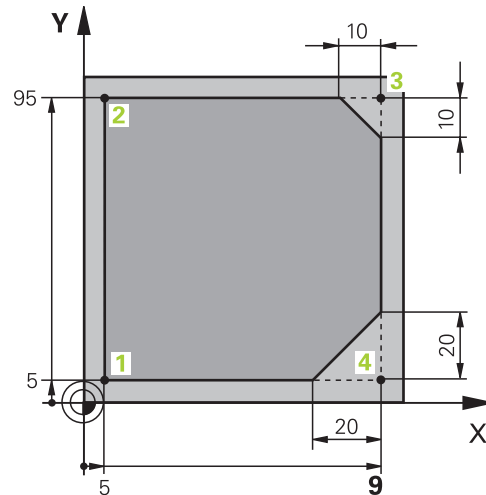

<b>0 BEGIN PGM LINEAR MM</b>	
<b>1 BLK FORM 0.1 Z X+0 Y+0 Z-20</b>	Define the workpiece blank for graphic workpiece simulation
<b>2 BLK FORM 0.2 X+100 Y+100 Z+0</b>	
<b>3 TOOL CALL 1 Z S4000</b>	Call the tool in the spindle axis and with spindle speed
<b>4 L Z+250 R0 FMAX</b>	Retract the tool in the spindle axis at rapid traverse FMAX
<b>5 L X-10 Y-10 R0 FMAX</b>	Pre-position the tool
<b>6 L Z-5 R0 F1000 M3</b>	Move to working depth at feed rate F = 1000 mm/min
<b>7 APPR LT X+5 y+5 LEN10 RL F300</b>	Approach the contour at point 1 on a straight line with tangential connection
<b>8 L Y+95</b>	Move to point 2
<b>9 L X+95</b>	Point 3: first straight line for corner 3
<b>10 CHF 10</b>	Program a chamfer with length 10 mm
<b>11 L Y+5</b>	Point 4: 2nd straight line for corner 3, 1st straight line for corner 4
<b>12 CHF 20</b>	Program a chamfer with length 20 mm
<b>13 L X+5</b>	Move to last contour point 1, second straight line for corner 4
<b>14 DEP LT LEN10 F1000</b>	Depart the contour on a straight line with tangential connection
<b>15 L Z+250 R0 FMAX M2</b>	Retract the tool, end program
<b>16 END PGM LINEAR MM</b>	

### Example: Circular movements with Cartesian coordinates

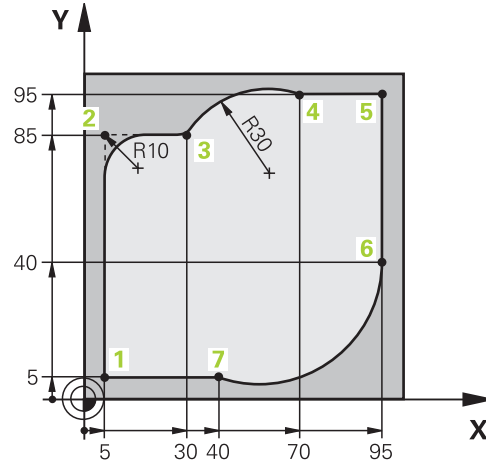

<b>0 BEGIN PGM CIRCULAR MM</b>	
<b>1 BLK FORM 0.1 Z X+0 Y+0 Z-20</b>	Define the workpiece blank for graphic workpiece simulation
<b>2 BLK FORM 0.2 X+100 Y+100 Z+0</b>	
<b>3 TOOL CALL 1 Z s4000</b>	Call the tool in the spindle axis and with spindle speed
<b>4 L Z+250 R0 FMAX</b>	Retract the tool in the spindle axis at rapid traverse FMAX
<b>5 L X-10 Y-10 R0 FMAX</b>	Pre-position the tool
<b>6 L Z-5 R0 F1000 M3</b>	Move to working depth at feed rate F = 1000 mm/min
<b>7 APPR LCT X+5 Y+5 R5 RL F300</b>	Approach the contour at point 1 on a circular arc with tangential connection
<b>8 L X+5 Y+85</b>	Point 2: First straight line for corner 2
<b>9 RND R10 F150</b>	Insert radius with R = 10 mm, feed rate: 150 mm/min
<b>10 L X+30 Y+85</b>	Move to point 3: Starting point of the arc with CR
<b>11 CR X+70 Y+95 R+30 DR-</b>	Move to point 4: End point of the arc with CR, radius 30 mm
<b>12 L X+95</b>	Move to point 5
<b>13 L X+95 Y+40</b>	Move to point 6
<b>14 CT X+40 Y+5</b>	Move to point 7: End point of the arc, circular arc with tangential connection to point 6, the control automatically calculates the radius
<b>15 L X+5</b>	Move to last contour point 1
<b>16 DEP LCT X-20 Y-20 R5 F1000</b>	Depart the contour on a circular arc with tangential connection
<b>17 L Z+250 R0 FMAX M2</b>	Retract the tool, end program
<b>18 END PGM CIRCULAR MM</b>	

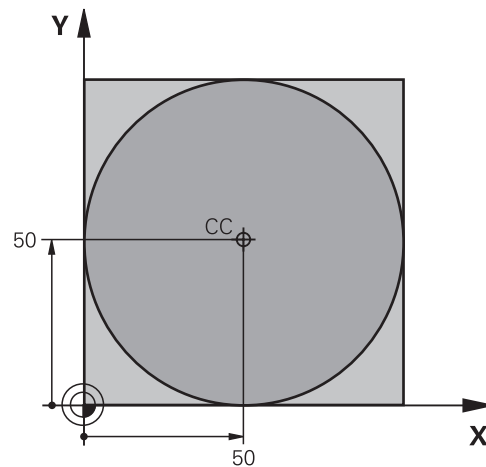
**Example: Full circle with Cartesian coordinates**

<b>0 BEGIN PGM C-CC MM</b>	
<b>1 BLK FORM 0.1 Z X+0 Y+0 Z-20</b>	Definition of workpiece blank
<b>2 BLK FORM 0.2 X+100 Y+100 Z+0</b>	
<b>3 TOOL CALL 1 Z S3150</b>	Tool call
<b>4 CC X+50 Y+50</b>	Define the circle center
<b>5 L Z+250 R0 FMAX</b>	Retract the tool
<b>6 L X-40 Y+50 R0 FMAX</b>	Pre-position the tool
<b>7 L Z-5 R0 F1000 M3</b>	Move to working depth
<b>8 APPR LCT X+0 Y+50 R5 RL F300</b>	Approach the starting point of the circle on a circular arc with tangential connection
<b>9 C X+0 DR-</b>	Move to the circle end point (= circle starting point)
<b>10 DEP LCT X-40 Y+50 R5 F1000</b>	Depart the contour on a circular arc with tangential connection
<b>11 L Z+250 R0 FMAX M2</b>	Retract the tool, end program
<b>12 END PGM C-CC MM</b>	

## 7.5 Path contours – Polar coordinates









### Overview

With polar coordinates you can define a position in terms of its angle **PA** and its distance **PR** relative to a previously defined pole **CC**.

Polar coordinates are useful with:

- Positions on circular arcs
- Workpiece drawing dimensions in degrees, e.g. bolt hole circles

### Overview of path functions with polar coordinates

Path function key	Tool movement	Required input	Page
 + 	Straight line	Polar radius, polar angle of the straight-line end point	301
 + 	Circular path around circle center/pole to arc end point	Polar angle of the arc end point, direction of rotation	302
 + 	Circular arc with tangential connection to the preceding contour element	Polar radius, polar angle of the arc end point	302
 + 	Combination of a circular and a linear movement	Polar radius, polar angle of the arc end point, coordinate of the end point in the tool axis	303

### Datum for polar coordinates: pole CC

You can set the pole CC at any point in the machining program, before indicating points in polar coordinates. Set the pole in the same way as you would program the circle center.

-  **Coordinates:** Enter Cartesian coordinates for the pole or, if you want to use the last programmed position, do not enter any coordinates. Before programming polar coordinates, define the pole. You can only define the pole in Cartesian coordinates. The pole remains in effect until you define a new pole.

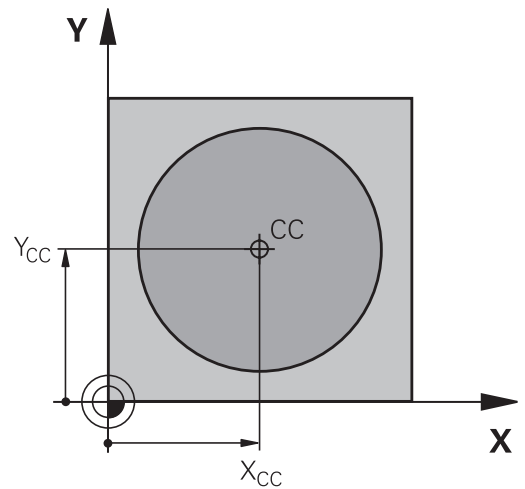

#### Example

12 CC X+45 Y+25



### Straight line LP

The tool moves in a straight line from its current position to the straight-line end point. The starting point is the end point of the preceding block.

-  **Polar coordinate radius PR:** Enter the distance from the pole CC to the straight-line end point.
-  **Polar coordinate angle PA:** Angular position of the straight-line end point between  $-360^\circ$  and  $+360^\circ$

The sign of PA depends on the angle reference axis:

- If the angle from the angle reference axis to PR is counterclockwise:  $PA > 0$
- If the angle from the angle reference axis to PR is clockwise:  $PA < 0$

#### Example

12 CC X+45 Y+25

13 LP PR+30 PA+0 RR F300 M3

14 LP PA+60

15 LP IPA+60

16 LP PA+180

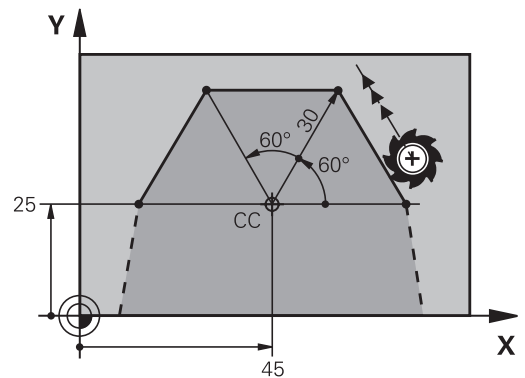

### Circular path CP around pole CC

The polar coordinate radius **PR** is also the radius of the arc. **PR** is defined by the distance from the starting point to the pole **CC**. The last programmed tool position will be the starting point of the arc.



- ▶ **Polar-coordinates angle PA:** Angular position of the arc end point between  $-99999.9999^\circ$  and  $+99999.9999^\circ$



- ▶ **Direction of rotation DR**

#### Example

```
18 CC X+25 Y+25
```

```
19 LP PR+20 PA+0 RR F250 M3
```

```
20 CP PA+180 DR+
```

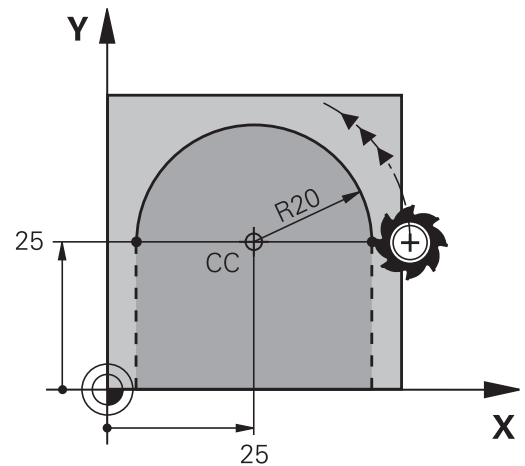

With incremental inputs you must enter DR and PA with the same sign.

Consider this behavior when importing programs from earlier controls. Adapt the program if required.

### Circle CTP with tangential connection

The tool moves on a circular path, starting tangentially from a preceding contour element.



- ▶ **Polar coordinate radius PR:** Distance between the arc end point and the pole **CC**



- ▶ **Polar coordinate angle PA:** Angular position of the arc end point.



The pole is **not** the center of the contour arc!

#### Example

```
12 CC X+40 Y+35
```

```
13 L X+0 Y+35 RL F250 M3
```

```
14 LP PR+25 PA+120
```

```
15 CTP PR+30 PA+30
```

```
16 L Y+0
```

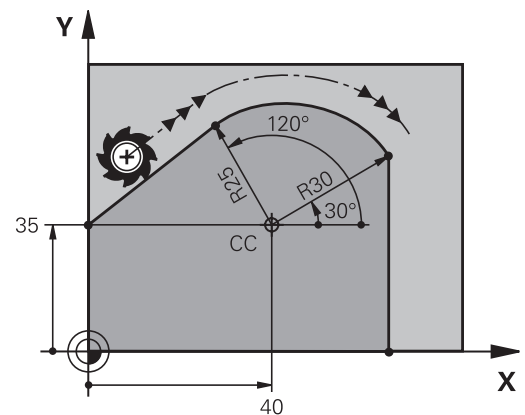

### Helix

A helix is a combination of a circular movement in a main plane and a linear movement perpendicular to this plane. You program the circular path in a main plane.

A helix is programmed only in polar coordinates.

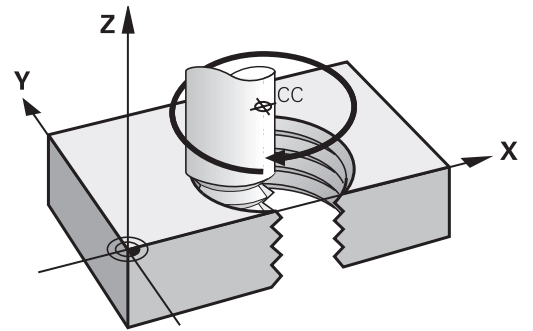

### Application

- Large-diameter internal and external threads
- Lubrication grooves

### Calculating the helix

To program a helix, you must enter the total angle through which the tool is to move on the helix in incremental dimensions, and the total height of the helix.

Thread revolutions n: Thread revolutions + overrun at start and end of thread

Total height h: Thread pitch P times thread revolutions n

Incremental total angle  
IPA: Thread revolutions x 360° + angle for beginning of thread + angle for thread overrun

Starting coordinate Z: Pitch P times (thread revolutions + thread overrun at start of thread)

### Shape of the helix

The table below illustrates in which way the shape of the helix is determined by the work direction, direction of rotation and radius compensation.

Internal thread	Work direction	Direction of rotation	Radius compensation
Right-hand	Z+	DR+	RL
Left-hand	Z+	DR-	RR
Right-hand	Z-	DR-	RR
Left-hand	Z-	DR+	RL
External thread			
Right-hand	Z+	DR+	RR
Left-hand	Z+	DR-	RL
Right-hand	Z-	DR-	RL
Left-hand	Z-	DR+	RR

### Programming a helix



Always enter the same algebraic sign for the direction of rotation and the incremental total angle **IPA**. The tool may otherwise move in a wrong path and damage the contour.

For the total angle **IPA** you can enter a value of  $-99\,999.9999^\circ$  to  $+99\,999.9999^\circ$ .

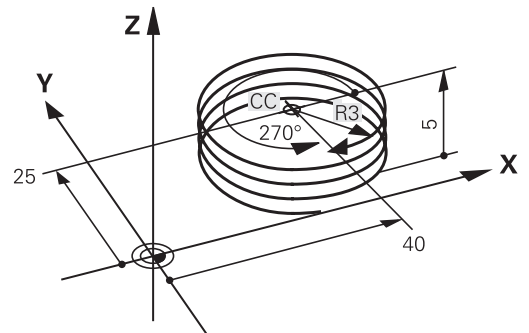

- ▶ **Polar coordinates angle:** Enter the total angle of tool traverse along the helix in incremental dimensions. **After entering the angle, specify the tool axis with an axis selection key.**
- ▶ **Coordinate:** Enter the coordinate for the height of the helix in incremental dimensions
- ▶ **Direction of rotation DR**  
Clockwise helix: DR-  
Counterclockwise helix: DR+
- ▶ **Enter the radius compensation** according to the table



### Example: Thread M6 x 1 mm with 5 revolutions

12 CC X+40 Y+25

13 L Z+0 F100 M3

14 LP PR+3 PA+270 RL F50

15 CP IPA-1800 IZ+5 DR-



**Example: Linear movement with polar coordinates**

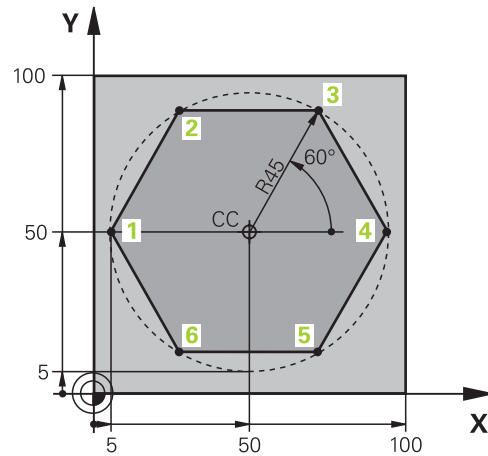

<b>0 BEGIN PGM LINEARPO MM</b>	
<b>1 BLK FORM 0.1 Z X+0 Y+0 Z-20</b>	Definition of workpiece blank
<b>2 BLK FORM 0.2 X+100 Y+100 Z+0</b>	
<b>3 TOOL CALL 1 Z S4000</b>	Tool call
<b>4 CC X+50 Y+50</b>	Define the preset for polar coordinates
<b>5 L Z+250 R0 FMAX</b>	Retract the tool
<b>6 LP PR+60 PA+180 R0 FMAX</b>	Pre-position the tool
<b>7 L Z-5 R0 F1000 M3</b>	Move to working depth
<b>8 APPR PLCT PR+45 PA+180 R5 RL F250</b>	Approach the contour at point 1 on a circular arc with tangential connection
<b>9 LP PA+120</b>	Move to point 2
<b>10 LP PA+60</b>	Move to point 3
<b>11 LP PA+0</b>	Move to point 4
<b>12 LP PA-60</b>	Move to point 5
<b>13 LP PA-120</b>	Move to point 6
<b>14 LP PA+180</b>	Move to point 1
<b>15 DEP PLCT PR+60 PA+180 R5 F1000</b>	Depart the contour on a circular arc with tangential connection
<b>16 L Z+250 R0 FMAX M2</b>	Retract the tool, end program
<b>17 END PGM LINEARPO MM</b>	

## Example: Helix

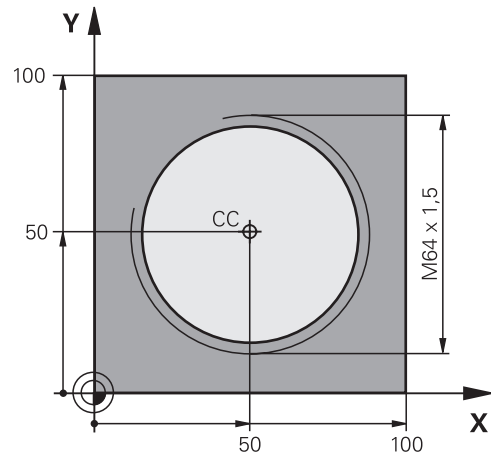

<b>0 BEGIN PGM HELIX MM</b>	
<b>1 BLK FORM 0.1 Z X+0 Y+0 Z-20</b>	Definition of workpiece blank
<b>2 BLK FORM 0.2 X+100 Y+100 Z+0</b>	
<b>3 TOOL CALL 1 Z S1400</b>	Tool call
<b>4 L Z+250 R0 FMAX</b>	Retract the tool
<b>5 L X+50 Y+50 R0 FMAX</b>	Pre-position the tool
<b>6 CC</b>	Transfer the last programmed position as the pole
<b>7 L Z-12.75 R0 F1000 M3</b>	Move to working depth
<b>8 APPR PCT PR+32 PA-182 CCA180 R+2 RL F100</b>	Approach the contour on a circular arc with tangential connection
<b>9 CP IPA+3240 IZ+13.5 DR+ F200</b>	Helical interpolation
<b>10 DEP CT CCA180 R+2</b>	Depart the contour on a circular arc with tangential connection
<b>11 L Z+250 R0 FMAX M2</b>	Retract the tool, end program
<b>12 END PGM HELIX MM</b>	

## 7.6 Path contours – FK free contour programming (option 19)

### Fundamentals

Workpiece drawings that are not dimensioned for NC often contain unconventional coordinate data that cannot be entered with the gray dialog keys.

You can enter such dimensional data directly by using the free contour programming function FK, e.g.

- If there are known coordinates on or in the proximity of the contour element
- If coordinate data refers to another contour element
- If directional data and data regarding the course of the contour are known

The control derives the contour from the known coordinate data and supports the programming dialog with the interactive FK programming graphics. The figure at upper right shows a workpiece drawing for which FK programming is the most convenient programming method.

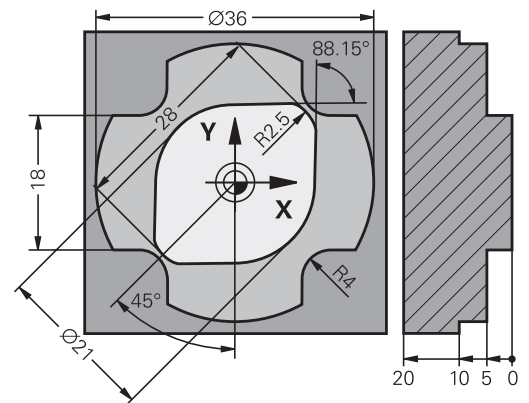



### Programming notes

The FK free contour programming feature can only be used for programming contour elements that lie in the working plane.

The working plane for FK programming is defined according to the following hierarchy:

- 1. Using the plane defined in an **FPOL** block
- 2. Using the working plane defined in the **TOOL CALL** (e.g. **TOOL CALL 1 TOOL CALLZ = X/Y** plane)
- 3. The standard X/Y plane is active if none of these applies

The display of the FK soft keys depends on the spindle axis in the workpiece blank definition. If for example you enter spindle axis **Z** in the workpiece blank definition, the control only shows FK soft keys for the X/Y plane.

You must enter all available data for every contour element. Even the data that does not change must be entered in every block—otherwise it will not be recognized.

Q parameters are permissible in all FK elements, except in elements with relative references (e.g. **RX** or **RAN**), or in elements that are referenced to other NC blocks.

If both FK blocks and conventional blocks are entered in a program, the FK contour must be fully defined before you can return to conventional programming.

The control needs a fixed point that it can use as the basis for all calculations. Use the gray path function keys to program a position that contains both coordinates of the working plane immediately before programming the FK contour. Do not enter any Q parameters in this block.

If the first block of an FK contour is an **FCT** or **FLT** block, you must program at least two NC blocks with the gray path function keys to fully define the direction of contour approach.

Do not program an FK contour immediately after an **LBL** command.

## FK programming graphics



If you wish to use graphic support during FK programming, select the **PROGRAM + GRAPHICS** screen layout.

**Further information:** "Programming", page 92

Incomplete coordinate data often is not sufficient to fully define a workpiece contour. In this case, the control indicates the possible solutions in the FK graphic. You can then select the contour that matches the drawing.

The control uses various colors in the FK graphics:

- **blue:** uniquely specified contour element  
The last FK element is only shown in blue after the departure movement.
- **violet:** not yet uniquely specified contour element
- **ocher:** tool midpoint path
- **red:** rapid traverse
- **green:** more than one solution is possible

If the data permit several possible solutions and the contour element is displayed in green, select the correct contour element as follows:



- ▶ Press the **SHOW SOLUTION** soft key repeatedly until the correct contour element is displayed. Use the zoom function if you cannot distinguish possible solutions in the standard setting



- ▶ If the displayed contour element matches the drawing, select the contour element with **SELECT SOLUTION**

If you do not yet wish to select a green contour element, press the **START SINGLE** soft key to continue the FK dialog.



Select the green contour elements as soon as possible with the **SELECT SOLUTION** soft key. This way you can reduce the ambiguity of subsequent elements.

### Showing block numbers in the graphic window

To show a block number in the graphic window:





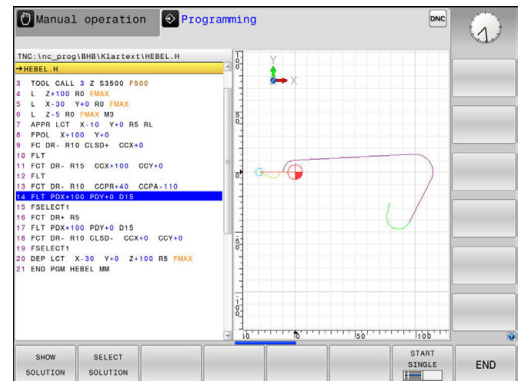

- ▶ Set the **SHOW OMIT BLOCK NR.** soft key to **SHOW** (soft-key row 3)





## Initiating the FK dialog

If you press the gray FK path function key, the control displays the soft keys you can use to initiate the FK dialog. Press the **FK** key a second time to deselect the soft keys.

If you initiate the FK dialog with one of these soft keys, the control shows additional soft-key rows that you can use for entering known coordinates, directional data and data regarding the course of the contour.

Soft key	FK element
	Straight line with tangential connection
	Straight line without tangential connection
	Circular arc with tangential connection
	Circular arc without tangential connection
	Pole for FK programming

## Pole for FK programming

-  ▶ To display the soft keys for free contour programming, press the **FK** key
-  ▶ To initiate the dialog for defining the pole, press the **FPOL** soft key
- > The control displays the axis soft keys of the active working plane.
- ▶ Enter the pole coordinates using these soft keys



The pole for FK programming remains active until you define a new one using FPOL.

## Free straight line programming

### Straight line without tangential connection



- ▶ To display the soft keys for free contour programming, press the **FK** key

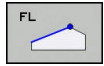

- ▶ To initiate the dialog for free programming of straight lines, press the **FL** soft key
- ▶ The control displays additional soft keys.
- ▶ Enter all known data in the block by using these soft keys
- ▶ The FK graphic displays the programmed contour element in violet until sufficient data is entered. If the entered data describes several solutions, the graphic will display the contour element in green.

**Further information:** "FK programming graphics", page 309

### Straight line with tangential connection

If the straight line connects tangentially to another contour element, initiate the dialog with the **FLT** soft key:



- ▶ To display the soft keys for free contour programming, press the **FK** key



- ▶ To initiate the dialog, press the **FLT** soft key
- ▶ Enter all known data in the block by using the soft keys

## Free circular path programming

### Circular arc without tangential connection



- ▶ To display the soft keys for free contour programming, press the **FK** key

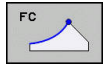

- ▶ To initiate the dialog for free programming of circular arcs, press the **FC** soft key
- ▶ The control displays soft keys with which you can enter direct data on the circular arc or data on the circle center.
- ▶ Enter all known data in the block by using these soft keys
- ▶ The FK graphic displays the programmed contour element in violet until sufficient data is entered. If the entered data describes several solutions, the graphic will display the contour element in green.

**Further information:** "FK programming graphics", page 309

### Circular arc with tangential connection

If the circular arc connects tangentially to another contour element, initiate the dialog with the **FCT** soft key:



- ▶ To display the soft keys for free contour programming, press the **FK** key

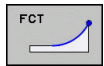



- ▶ To initiate the dialog, press the **FCT** soft key
- ▶ Enter all known data in the block by using the soft keys

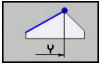

## Input possibilities

### End point coordinates

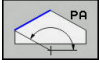
Soft keys	Known data
 	Cartesian coordinates X and Y
 	Polar coordinates referenced to FPOL

### Example



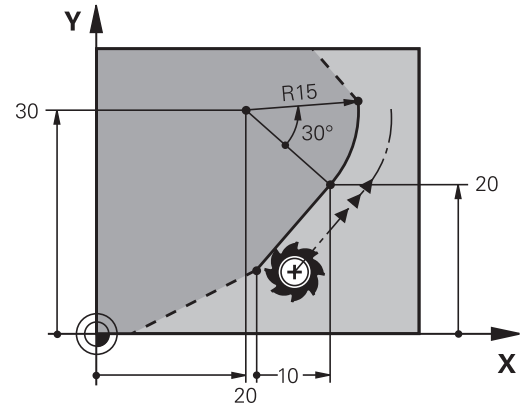

7 FPOL X+20 Y+30

8 FL IX+10 Y+20 RR F100

9 FCT PR+15 IPA+30 DR+ R15



### Direction and length of contour elements

Soft keys	Known data
	Length of a straight line
	Gradient angle of a straight line
	Chord length LEN of an arc
	Gradient angle AN of an entry tangent
	Center angle of an arc

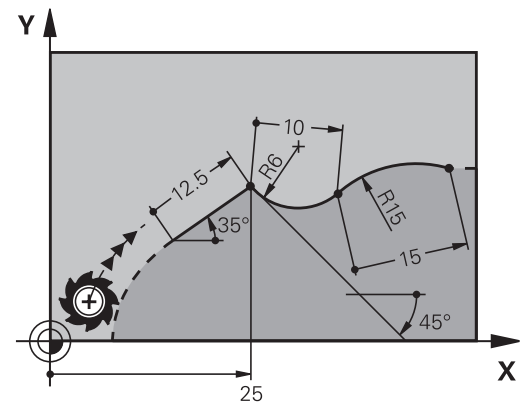
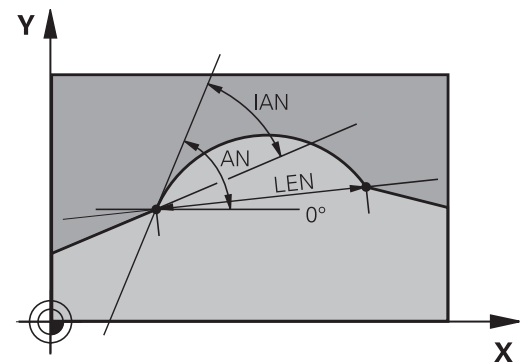

## NOTICE

### Danger of collision!

Incremental gradient angles **IAN** are referenced by the control to the direction of the previous traversing block. NC programs from previous control models (including iTNC 530) are not compatible. There is danger of collision during the execution of imported NC programs!

- ▶ Check the sequence and contour with the aid of the graphic simulation
- ▶ Adapt imported NC programs if required

### Example

27 FLT X+25 LEN 12.5 AN+35 RL F200

28 FC DR+ R6 LEN 10 AN-45

29 FCT DR- R15 LEN 15

### Circle center **CC**, radius and direction of rotation in the **FC/FCT** block

The control calculates a circle center for free-programmed arcs from the data you enter. This makes it possible to program full circles in an FK program block.

If you wish to define the circle center in polar coordinates you must use **FPOL**, not **CC**, to define the pole. **FPOL** is entered in Cartesian coordinates and remains in effect until the control encounters a block in which another **FPOL** is defined.



A programmed or automatically calculated circle center or pole is effective only in connected conventional or FK sections. If an FK section splits up two conventionally programmed sections, the information about a circle center or pole will be lost. The two conventionally programmed sections must each have their own (if necessary, identical) **CC** blocks. Conversely, this information will also be lost if there is a conventional section between two FK sections.

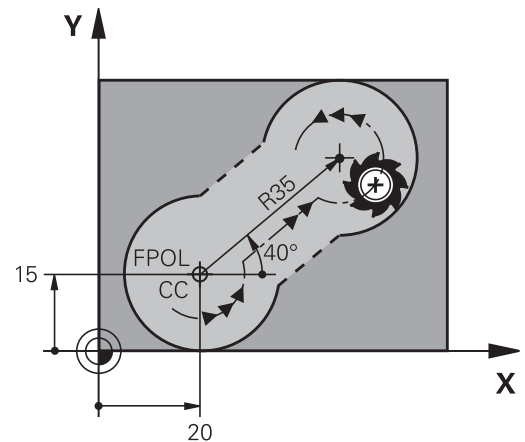

#### Soft keys

#### Known data

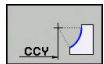
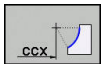

Circle center in Cartesian coordinates

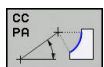
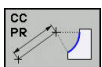

Center point in polar coordinates



Rotational direction of the arc

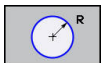

Radius of an arc

#### Example

```
10 FC CCX+20 CCY+15 DR+ R15
```

```
11 FPOL X+20 Y+15
```

```
12 FL AN+40
```

```
13 FC DR+ R15 CCPR+35 CCPA+40
```

**Closed contours**

You can identify the beginning and end of a closed contour with the **CLSD** soft key. This reduces the number of possible solutions for the last contour element.

Enter **CLSD** as an addition to another contour data entry in the first and last blocks of an FK section.



Beginning of contour: CLSD+  
 End of contour: CLSD-

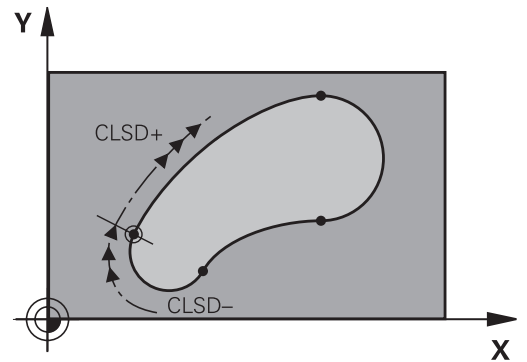

**Example**











```
12 L X+5 Y+35 RL F500 M3
13 FC DR- R15 CLSD+ CCX+20 CCY+35
...
17 FC DR- R+15 CLSD-
```

## Auxiliary points







For both free-programmed straight lines and free-programmed circular arcs, you can enter the coordinates of auxiliary points that are located on the contour or in its proximity.

### Auxiliary points on a contour

The auxiliary points are located on the straight line, the extension of the straight line, or on the circular arc.

Soft keys	Known data
 	X coordinate of an auxiliary point P1 or P2 of a straight line
 	Y coordinate of an auxiliary point P1 or P2 of a straight line
  	X coordinate of an auxiliary point P1, P2 or P3 of a circular path
  	Y coordinate of an auxiliary point P1, P2 or P3 of a circular path

### Auxiliary points near a contour

Soft keys	Known data
 	X and Y coordinates of the auxiliary point near a straight line
	Distance of auxiliary point to straight line
 	X and Y coordinates of an auxiliary point near a circular arc
	Distance of auxiliary point to circular arc

### Example

```
13 FC DR- R10 P1X+42.929 P1Y+60.071
```

```
14 FLT AN-70 PDX+50 PDY+53 D10
```

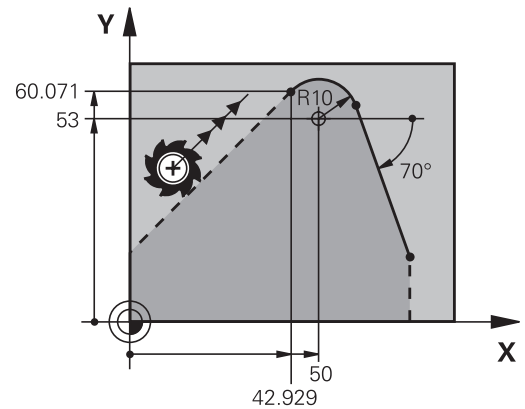

### Relative data

Relative data are values based on another contour element. The soft keys and program words for relative entries begin with the letter **R**. The figure on the right shows the dimensional data that should be programmed as relative data.

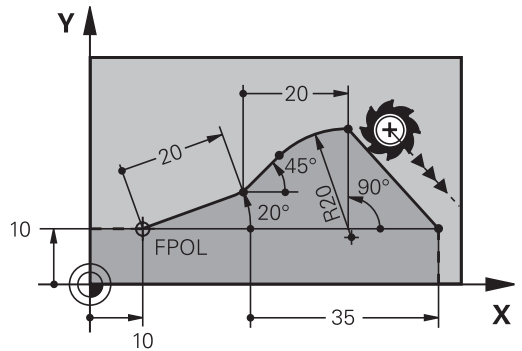

The coordinates and angles for relative data are always programmed in incremental dimensions. You must also enter the block number of the contour element on which the data are based.

The block number of the contour element on which the relative data are based can only be located up to 64 positioning blocks before the block in which you program the reference.

If you delete a block on which relative data are based, the control will display an error message. Change the program first before you delete the block.

#### Data relative to block N: End point coordinates

##### Soft keys

##### Known data

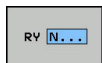
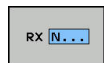

Cartesian coordinates relative to block N

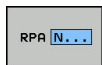
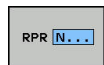

Polar coordinates relative to block N

#### Example

12 FPOL X+10 Y+10



13 FL PR+20 PA+20

14 FL AN+45

15 FCT IX+20 DR- R20 CCA+90 RX 13

16 FL IPR+35 PA+0 RPR 13

### Data relative to block N: Direction and distance of the contour element

Soft key	Known data
 RAN [N...]	Angle between a straight line and another element or between the entry tangent of the arc and another element
 PAR [N...]	Straight line parallel to another contour element
 DP	Distance from a straight line to a parallel contour element

### Example



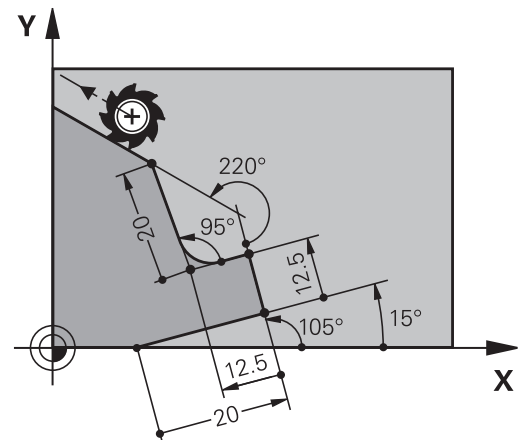

```

17 FL LEN 20 AN+15
18 FL AN+105 LEN 12.5
19 FL PAR 17 DP 12.5
20 FSELECT 2
21 FL LEN 20 IAN+95
22 FL IAN+220 RAN 18

```



### Data relative to block N: Circle center CC

Soft key	Known data
 RCCX [N...]	Cartesian coordinates of the circle center relative to block N
 RCCY [N...]	
 RCCPR [N...]	Polar coordinates of the circle center relative to block N
 RCCPA [N...]	

### Example

```

12 FL X+10 Y+10 RL
13 FL ...
14 FL X+18 Y+35
15 FL ...
16 FL ...
17 FC DR- R10 CCA+0 ICCX+20 ICCY-15 RCCX12 RCCY14

```

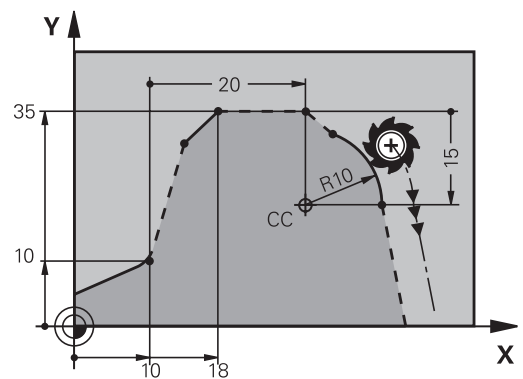

## Example: FK programming 1

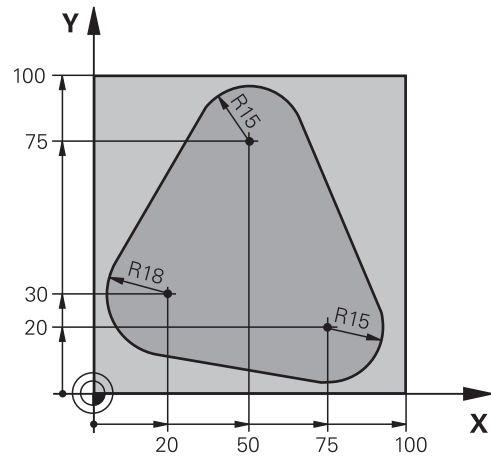

<b>0 BEGIN PGM FK1 MM</b>	
<b>1 BLK FORM 0.1 Z X+0 Y+0 Z-20</b>	Definition of workpiece blank
<b>2 BLK FORM 0.2 X+100 Y+100 Z+0</b>	
<b>3 TOOL CALL 1 Z S500</b>	Tool call
<b>4 L Z+250 R0 FMAX</b>	Retract the tool
<b>5 L X-20 Y+30 R0 FMAX</b>	Pre-position the tool
<b>6 L Z-10 R0 F1000 M3</b>	Move to working depth
<b>7 APPR CT X+2 Y+30 CCA90 R+5 RL F250</b>	Approach the contour on a circular arc with tangential connection
<b>8 FC DR- R18 CLSD+ CCX+20 CCY+30</b>	FK contour section:
<b>9 FLT</b>	Program all known data for each contour element
<b>10 FCT DR- R15 CCX+50 CCY+75</b>	
<b>11 FLT</b>	
<b>12 FCT DR- R15 CCX+75 CCY+20</b>	
<b>13 FLT</b>	
<b>14 FCT DR- R18 CLSD- CCX+20 CCY+30</b>	
<b>15 DEP CT CCA90 R+5 F1000</b>	Depart the contour on a circular arc with tangential connection
<b>16 L X-30 Y+0 R0 FMAX</b>	
<b>17 L Z+250 R0 FMAX M2</b>	Retract the tool, end program
<b>18 END PGM FK1 MM</b>	





## Example: FK programming 3

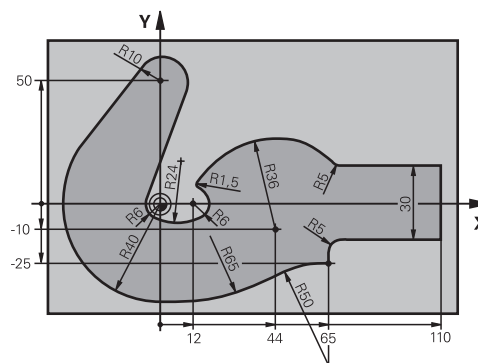

0 BEGIN PGM FK3 MM	
1 BLK FORM 0.1 Z X-45 Y-45 Z-20	Definition of workpiece blank
2 BLK FORM 0.2 X+120 Y+70 Z+0	
3 TOOL CALL 1 Z S4500	Tool call
4 L Z+250 R0 FMAX	Retract the tool
5 L X-70 Y+0 R0 FMAX	Pre-position the tool
6 L Z-5 R0 F1000 M3	Move to working depth
7 APPR CT X-40 Y+0 CCA90 R+5 RL F250	Approach the contour on a circular arc with tangential connection
8 FC DR- R40 CCX+0 CCY+0	FK contour section:
9 FLT	Program all known data for each contour element
10 FCT DR- R10 CCX+0 CCY+50	
11 FLT	
12 FCT DR+ R6 CCX+0 CCY+0	
13 FCT DR+ R24	
14 FCT DR+ R6 CCX+12 CCY+0	
15 FSELECT 2	
16 FCT DR- R1.5	
17 FCT DR- R36 CCX+44 CCY-10	
18 FSELECT 2	
19 FCT DR+ R5	
20 FLT X+110 Y+15 AN+0	
21 FL AN-90	
22 FL X+65 AN+180 PAR21 DP30	
23 RND R5	
24 FL X+65 Y-25 AN-90	
25 FC DR+ R50 CCX+65 CCY-75	
26 FCT DR- R65	
27 FSELECT 1	
28 FCT Y+0 DR- R40 CCX+0 CCY+0	
29 FSELECT 4	

<b>30 DEP CT CCA90 R+5 F1000</b>	Depart the contour on a circular arc with tangential connection
<b>31 L X-70 R0 FMAX</b>	
<b>32 L Z+250 R0 FMAX M2</b>	Retract the tool, end program
<b>33 END PGM FK3 MM</b>	

# 8

**Data Transfer from  
CAD Files**

## 8.1 Screen layout of the CAD viewer

### Fundamentals of the CAD viewer

#### Screen display

When you open the **CAD-Viewer**, the following screen layout is displayed:

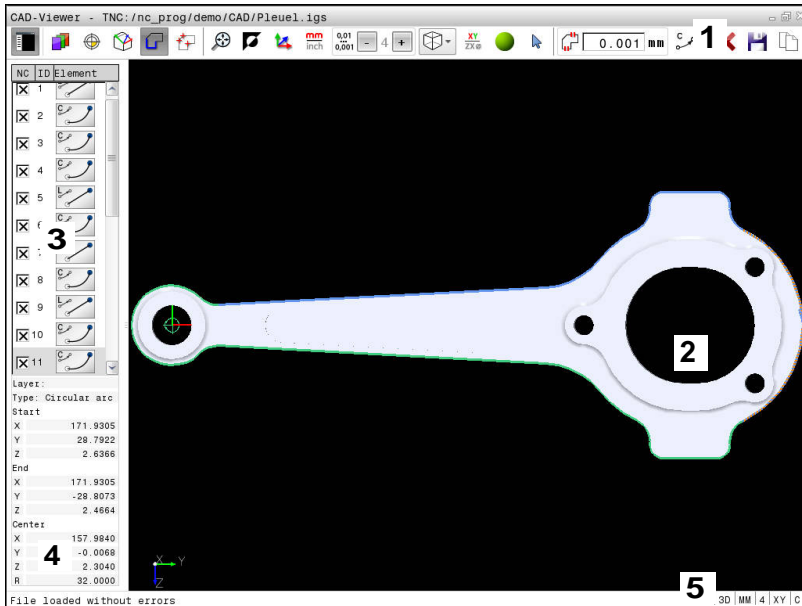

- 1 Menu bar
- 2 Graphics window
- 3 List View window
- 4 Window element information
- 5 Status bar

#### File formats

The **CAD-Viewer** enables you to open standardized CAD data formats directly on the control.

The control displays the following file formats:

File	Type	Format
Step	.STP and .STEP	<ul style="list-style-type: none"> <li>■ AP 203</li> <li>■ AP 214</li> </ul>
IGES	.IGS and .IGES	<ul style="list-style-type: none"> <li>■ Version 5.3</li> </ul>
DXF	.DXF	<ul style="list-style-type: none"> <li>■ R10 to 2015</li> </ul>

## 8.2 CAD import (option 42)

### Application

You can open CAD files directly on the control in order to extract contours or machining positions and save them as Klartext programs or as point files. Klartext programs acquired in this manner can also be run on older HEIDENHAIN controls, since these contour programs contain only **L** and **CC/C** blocks.

If you process files in **Programming** mode, the control generates contour programs with the file extension **.H** and point files with the extension **.PNT** by default. You can select the file type in the save dialog. To insert a selected contour or a selected machining position directly in an NC program, use the control's clipboard.



#### Operating notes:

- Before loading the file into the control, ensure that the name of the file contains only permitted characters. **Further information:** "File names", page 169
- The control does not support binary DXF format. Save the DXF file in ASCII format in the CAD or drawing program.

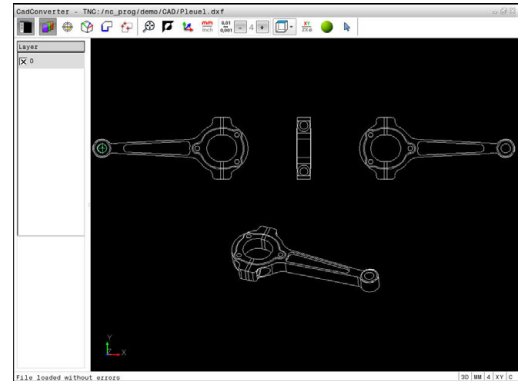

## Using the CAD viewer



To use the **CAD-Viewer** without touchscreen, you have to use a mouse or touchpad. All operating modes and functions as well as contours and machining positions can only be selected with the mouse or touch pad.

The **CAD-Viewer** runs as a separate application on the third desktop of the control. This enables you to use the screen switchover key to switch between the machine operating modes, the programming modes and the **CAD-Viewer**. This is particularly useful if you want to add contours or machining positions to a Klartext program by copy and paste using the clipboard.



If you are using a TNC 620 with touch control, you can replace some keystrokes with hand-to-screen contact.

**Further information:** "Operating the Touchscreen", page 123

## Opening the CAD file



- ▶ Press the **Programming** key



- ▶ To call the file manager, press the **PGM MGT** key



- ▶ In order to see the soft key menu for selecting the file types to be displayed, press the **SELECT TYPE** soft key



- ▶ To show all CAD files, press the **SHOW CAD** or **SHOW ALL** soft key

- ▶ Select the directory in which the CAD file is saved















- ▶ Select the desired CAD file



- ▶ Press the **ENT** key
- ▶ The control starts the **CAD-Viewer** and shows the file contents on the screen. The control displays the layers in the List View window and the drawing in the Graphics window.





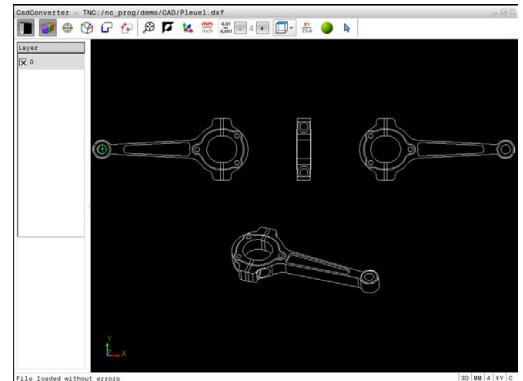

## Basic settings

The basic settings specified below are selected using the icons in the toolbar.

Icon	Setting
	Show or hide the Window List view to expand the Graphics window
	Display of the various layers
	Set a preset
	Set the datum
	Select the contour
	Select hole positions
	Set the zoom to the largest possible view of the complete graphics
	Change the background color (black or white)
	Switch between 2-D and 3-D mode. The active mode is color-highlighted
	Set the unit of measure, <b>mm</b> or <b>inch</b> , for the file. The control then outputs the contour program and the machining positions in this unit of measure. The active unit of measure is highlighted in red
	Set resolution: The resolution specifies how many decimal places the control will use when generating the contour program. Default setting: 4 decimal places with <b>mm</b> and 5 decimal places with <b>inch</b>
	Switch between various view of the model e.g. <b>Top</b>
	Selection and deselection: The active + symbol is the same as the pressed <b>Shift</b> key, and the active - symbol is the same as the pressed <b>CTRL</b> key. The active <b>cursor</b> symbol is the same as the mouse

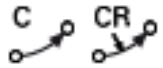
The following icons are displayed by the control only in certain modes.



Icon	Setting
	The most recent step is undone.
	Contour assumption mode: The tolerance specifies how far apart neighboring contour elements may be from each other. You can use the tolerance to compensate for inaccuracies that occurred when the drawing was made. The default setting is 0.001 mm
	Arc mode: Arc mode defines whether circular arcs are output in C format or CR format (e.g. for cylinder surface interpolation) in the NC program.
	Point assumption mode: Specify whether the control should display the tool path as a dashed line during selection of machining positions
	Path optimization mode: The control optimizes the tool traverse movement to give the shortest traverse movements between the machining positions. Optimization is reset with repeated actuations
	Hole position mode: The control opens a pop-up window in which you can filter the holes by size



#### Operating notes:

- Set the correct unit of measure, since the CAD file does not contain any such information.
- When generating NC programs for previous control models, you must limit the resolution to three decimal places. In addition, you must remove the comments that the **CAD-Viewer** inserts into the contour program.
- The control displays the active basic settings in the status bar of the screen.



## Setting layers

CAD files usually contain several layers. The designer uses these layers to create groups of various types of elements, e.g. the actual workpiece contour, dimensions, auxiliary and design lines, shadings, and texts.

Hiding unneeded layers makes the graphics easier to read and facilitates the extraction of the required information.



### Operating notes:

- The CAD file to be processed must contain at least one layer. Elements not assigned to a layer are automatically moved by the control to the anonymous layer.
- You can even select a contour if the designer has saved the lines on different layers.

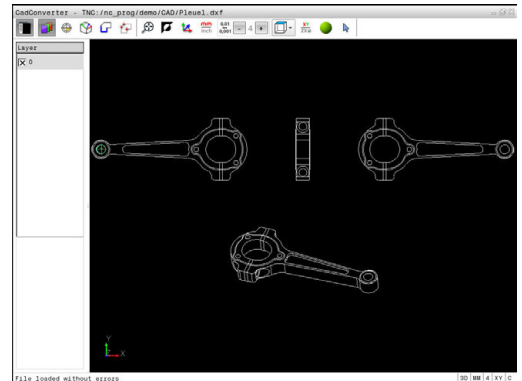

- ▶ Select the mode for the layer settings
- > In the List View window the control shows all layers contained in the active CAD file
- ▶ Hide a layer: Select the layer with the left mouse button, and click its check box to hide it
- ▶ Alternatively, use the space key
- ▶ Show a layer: Select the layer with the left mouse button, and click its check box to show it
- ▶ Alternatively, use the space key

## Setting a preset

The datum of the drawing in the CAD file is not always located in a manner that lets you use it directly as a workpiece preset. Therefore, the control has a function with which you can shift the workpiece preset to a suitable location by clicking an element. You can also define the orientation of the coordinate system.

You can define a preset at the following locations:

- At the beginning, end or center of a straight line
- At the beginning, center or end of a circular arc
- At the transition between quadrants or at the center of a complete circle
- At the intersection between:
  - A straight line and a straight line, even if the intersection is actually on the extension of one of the lines
  - Straight line – circular arc
  - Straight line – full circle
  - Circle – circle (regardless of whether a circular arc or a full circle)

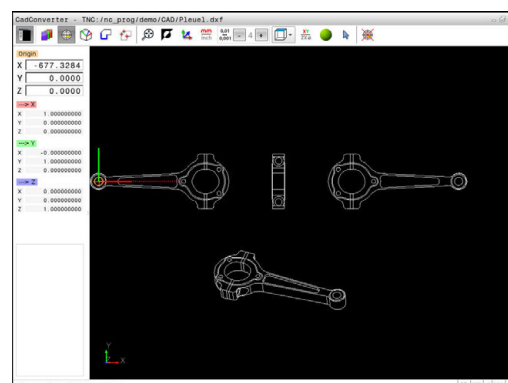

### Operating notes:

- You can change the preset even after you have selected the contour. The control does not calculate the actual contour data until you save the selected contour in a contour program.
- The preset and optional orientation are inserted in the NC program as a comment starting with **origin**.

## Selecting a preset on a single element



- ▶ Select the mode for specifying the preset
- ▶ Click the desired element with the mouse
- > The control indicates possible locations for presets on the selected element with stars.
- ▶ Click the star you want to select as preset
- ▶ Use the zoom function if the selected element is too small
- > The control sets the preset symbol at the selected location.
- > You can adjust the orientation of the coordinate system, if required.

**Further information:** "Adjusting the orientation of the coordinate system", page 331

### Selecting a preset on the intersection of two elements





- ▶ Select the mode for specifying the preset
- ▶ Click the first element (straight line, circle or circular arc) with the left mouse button
- > The element is color-highlighted.
- ▶ Click the second element (straight line, circle or circular arc) with the left mouse button
- > The control sets the preset symbol on the intersection.
- > You can adjust the orientation of the coordinate system, if required.

**Further information:** "Adjusting the orientation of the coordinate system", page 331



#### Operating notes:

- If there are several possible intersections, the control selects the intersection nearest the mouse-click on the second element.
- If two elements do not intersect directly, the control automatically calculates the intersection of their extensions.
- If the control cannot calculate an intersection, it deselects the previously selected element.

If a preset is set, the color of the  "Setting a preset" icon changes. You can delete a preset by pressing the  icon.

### Adjusting the orientation of the coordinate system

The position of the coordinate system is defined by the orientation of the axes.



- ▶ The preset has already been set
- ▶ Left-click an element that is in the positive X direction
- > The control aligns the X axis and displays it in red in the list view.
- ▶ Left-click an element that is approximately in the positive Y direction
- > The control aligns the Y and Z axes and displays them in green and blue in the list view.

### Element Information

In the Element Information window, the control shows how far the preset you have chosen is located from the drawing datum, and how this reference system is oriented with respect to the drawing.

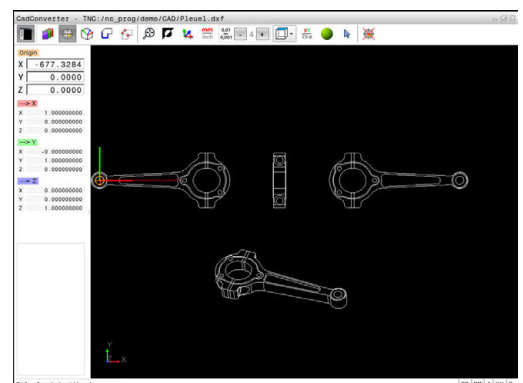

## Defining the datum

The workpiece preset is not always located in a manner that lets you machine the entire part. Therefore, the control has a function with which you can define a new datum and a tilting operation. You can also define the orientation of the coordinate system.

The datum with the orientation of the coordinate system can be defined at the same positions as a preset.

**Further information:** "Setting a preset", page 330



The datum and its optional orientation can be inserted as comments in the NC program by using the **TRANS DATUM AXIS** function for the datum and the **PLANE VECTOR** function for the orientation.

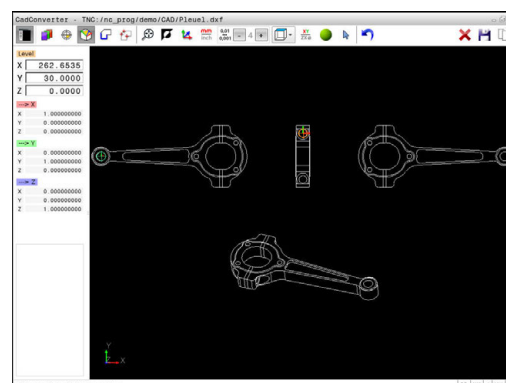

## Selecting the datum on a single element



- ▶ Select the mode for specifying the datum
- ▶ Click the desired element with the mouse
- > The control indicates possible locations for the datum on the selected element with stars.
- ▶ Click the star you want to select as datum
- ▶ Use the zoom function if the selected element is too small
- > The control sets the preset symbol at the selected location.
- > You can adjust the orientation of the coordinate system, if required.

**Further information:** "Adjusting the orientation of the coordinate system", page 333

### Selecting a datum on the intersection of two elements



- ▶ Select the mode for specifying the datum
- ▶ Click the first element (straight line, circle or circular arc) with the left mouse button
- > The element is color-highlighted.
- ▶ Click the second element (straight line, circle or circular arc) with the left mouse button
- > The control sets the preset symbol on the intersection.
- > You can adjust the orientation of the coordinate system, if required.

**Further information:** "Adjusting the orientation of the coordinate system", page 333



Operating notes:

- If there are several possible intersections, the control selects the intersection nearest the mouse-click on the second element.
- If two elements do not intersect directly, the control automatically calculates the intersection of their extensions.
- If the control cannot calculate an intersection, it deselects the previously selected element.

When a datum has been set, the color of the datum setting icon  changes.

You can delete a datum by pressing the  icon.

### Adjusting the orientation of the coordinate system

The position of the coordinate system is defined by the orientation of the axes.



- ▶ The datum has already been set
- ▶ Left-click an element that is in the positive X direction
- > The control aligns the X axis and displays it in red in the list view.
- ▶ Left-click an element that is approximately in the positive Y direction
- > The control aligns the Y and Z axes and displays them in green and blue in the list view.

### Element information

In the Element Information window, the control shows how far the datum you have chosen is located from the workpiece preset.

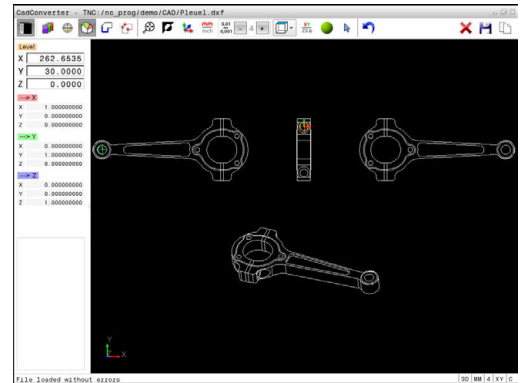

## Selecting and saving a contour



### Operating notes:

- Demo mode is active if option 42 is not enabled. You can select a maximum of 10 elements in demo mode.
- Specify the direction of rotation during contour selection so that it matches the desired machining direction.
- Select the first contour element such that approach without collision is possible.
- If the contour elements are very close to one another, use the zoom function.

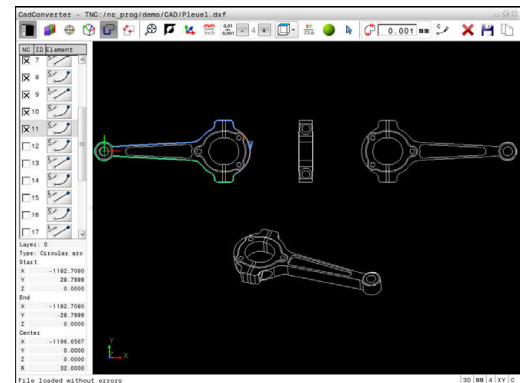

The following elements are selectable as contours:

- Line segment
- Circle
- Circular arc
- Polyline

On curved elements, such as splines or ellipses, you can select the end points and center points. They can also be selected as part of contours and converted to polylines during export.

### Element information

In the Element Information window the control displays a range of information about the last contour element you selected in the List View window or in the Graphics window.

- **Layer:** Indicates the layer you are currently on
- **Type:** Indicates the current element type, e.g. line
- **Coordinates:** Shows the starting point and end point of an element, and circle center and radius where appropriate



- ▶ Select the contour selection mode
- ▶ The Graphics window is active for the contour selection.
- ▶ To select a contour element, click the element with the mouse
- ▶ The control displays the machining sequence as a dashed line.
- ▶ Position the mouse on the other side of the center point of an element to modify the machining sequence
- ▶ Select the element with the left mouse button
- ▶ The selected contour element turns blue.
- ▶ If further contour elements in the selected machining sequence are selectable, the control highlights these elements in green. At junctions, the control chooses the element with the least deviation in direction.
- ▶ Click the last green element to add all elements to the contour program
- ▶ The control shows all selected contour elements in the List View window. Elements that are still green are displayed without a check mark in the **NC** column. The control does not save these elements to the contour program.
- ▶ You can also add selected elements to the contour program by clicking them in the List View window
- ▶ If necessary you can also deselect elements that you already selected by clicking the element in the Graphics window again, but this time while pressing the **CTRL** key



- ▶ Alternative: Click the icon to deselect all selected elements



- ▶ Save the selected contour elements to the clipboard of the control so that you can then insert the contour in a Klartext program



- ▶ Alternative: Save the selected contour elements as a Klartext program
- ▶ The control displays a pop-up window in which you can select the target directory, a file name, and the file type.



- ▶ Confirm the entry
- ▶ The control saves the contour program to the selected directory.



- ▶ If you want to select more contours, press the Cancel Selected Elements soft key and select the next contour as described above





## Operating notes:

- The control also transfers two workpiece-blank definitions (**BLK FORM**) to the contour program. The first definition contains the dimensions of the entire CAD file. The second one, which is the active one, contains only the selected contour elements, so that an optimized size of the workpiece blank results.
- The control only saves elements that have been selected (blue elements), which means that they have been given a check mark in the List View window.

### Dividing, extending and shortening contour elements

Proceed as follows to modify contour elements:



- ▶ The Graphics window is active for the contour selection
- ▶ To select the starting point, select an element or the intersection between two elements (using the + icon)
- ▶ Select the next contour element by clicking it with the mouse
- ▶ The control displays the machining sequence as a dashed line.
- ▶ When the element is selected the control displays it in blue.
- ▶ If the elements cannot be connected the control displays the selected element in gray.
- ▶ If further contour elements in the selected machining sequence are selectable, the control highlights these elements in green. At junctions, the control chooses the element with the least deviation in direction.
- ▶ Click the last green element to add all elements to the contour program.

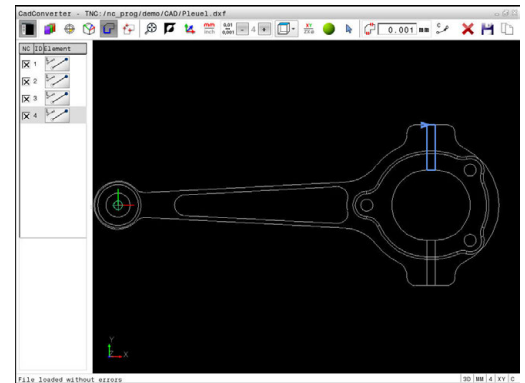

## Operating notes:

- You select the machining sequence of the contour with the first contour element.
- If the contour element to be extended or shortened is a straight line, then the control extends or shortens the contour element along the same line. If the contour element to be extended or shortened is a circular arc, then the control extends or shortens the contour element along the same arc.

## Selecting and saving machining positions



### Operating notes:

- Demo mode is active if option 42 is not enabled. You can select a maximum of 10 elements in demo mode.
- If the contour elements are very close to one another, use the zoom function.
- If required, configure the basic settings so that the control shows the tool paths. **Further information:** "Basic settings", page 327

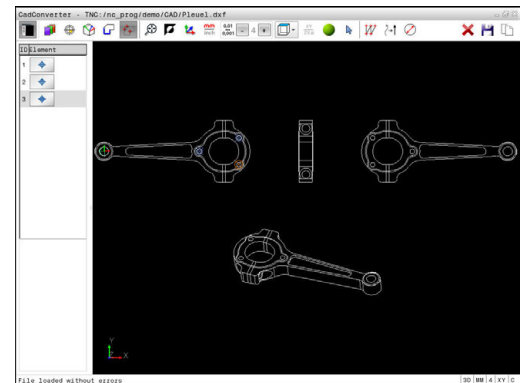

Three possibilities are available in the pattern generator for defining machining positions:

- Single selection: You select the desired machining position through individual mouse clicks.  
**Further information:** "Single selection", page 339
- Rapid selection of hole positions with the mouse area: By dragging the mouse to define an area, you can select all the hole positions within this area.  
**Further information:** "Rapid selection of hole positions with the mouse area", page 340
- Rapid selection of hole positions via an icon: Click the icon and the control then displays all existing hole diameters.  
**Further information:** "Rapid selection of hole positions via icon", page 341

## Selecting the file type

The following file types are available:

- Point table (.PNT)
- Klartext conversational language program (.H)

If you save the machining positions to a Klartext program, the control creates a separate linear block with cycle call for every machining position (**L X... Y... Z... F MAX M99**). You can also transfer this program to older TNC controls and run it there.



The point tables (.PNT) of the TNC 640 and iTNC 530 are not compatible. Transferring and processing on the other control type in each case may lead to problems and unforeseen performance.

### Single selection



- ▶ Select the mode for choosing a machining position
- > The Graphics window is active for position selection.
- ▶ To select a machining position, click the element with the mouse
- > The control displays the element in orange.
- > If the shift key is pressed at the same time, the control indicates possible machining positions on the element with stars.
- ▶ If you click a circle, the control adopts the circle center as machining position
- > If the shift key is pressed at the same time, the control indicates possible machining positions with stars.
- > The control loads the selected position into the List View window (displays a point symbol).
- ▶ If necessary you can also deselect elements that you already selected by clicking the element in the Graphics window again, but this time while pressing the CTRL key
- ▶ Alternative: Select the element in the List View window and press the **DEL** key
- ▶ Alternative: Click the icon to deselect all selected elements
- ▶ Save the selected machining positions to the clipboard of the control so that you can then insert them as a positioning block with cycle call in a Klartext program
- ▶ Alternative: Save the selected machining positions as a point file
- > The control displays a pop-up window in which you can select the target directory, a file name, and the file type.
- ▶ Confirm the entry
- > The control saves the contour program to the selected directory.
- ▶ If you want to select more machining positions, press the Cancel Selected Elements icon and select as described above

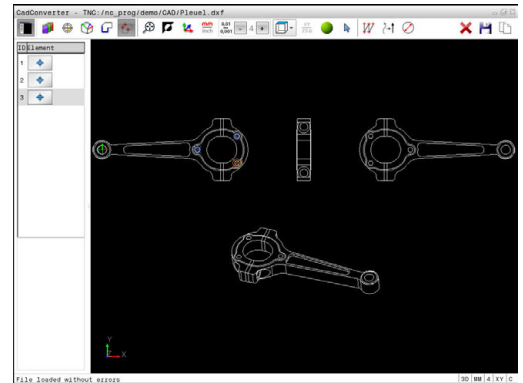

### Rapid selection of hole positions with the mouse area



- ▶ Select the mode for choosing a machining position
- ▶ The Graphics window is active for position selection.
- ▶ To select machining positions, press the shift key and define an area with the left mouse button
- ▶ All complete circles that are fully enclosed within the area are adopted as hole positions by the control.
- ▶ The control opens a pop-up window in which you can filter the holes by size.
- ▶ Configure the filter settings and press the **OK** button to confirm

**Further information:** "Filter settings", page 342

- ▶ The control loads the selected positions into the List View window (displays a point symbol).
- ▶ If necessary you can also deselect elements that you already selected by clicking the element in the Graphics window again, but this time while pressing the CTRL key
- ▶ Alternative: Select the element in the List View window and press the **DEL** key
- ▶ Alternative: Deselect all elements by dragging an area open again, but this time while pressing the CTRL key
- ▶ Save the selected machining positions to the clipboard of the control so that you can then insert them as a positioning block with cycle call in a Klartext program
- ▶ Alternative: Save the selected machining positions as a point file
- ▶ The control displays a pop-up window in which you can select the target directory, a file name, and the file type.
- ▶ Confirm the entry
- ▶ The control saves the contour program to the selected directory.
- ▶ If you want to select more machining positions, press the Cancel Selected Elements icon and select as described above

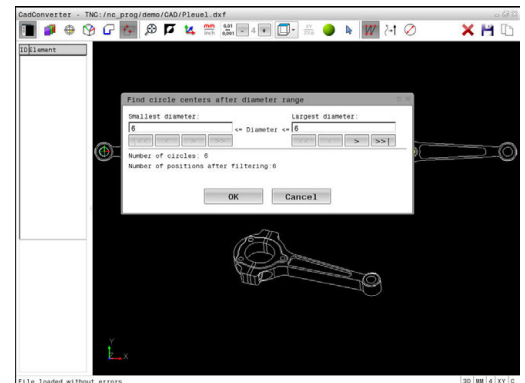

### Rapid selection of hole positions via icon



- ▶ Select the mode for choosing machining positions
- ▶ The Graphics window is active for position selection.



- ▶ Select the icon
- ▶ The control opens a pop-up window in which you can filter the holes by size.
- ▶ Configure the filter settings if required and press the **OK** button to confirm
- ▶ **Further information:** "Filter settings", page 342
- ▶ The control loads the selected positions into the List View window (displays a point symbol).
- ▶ If necessary you can also deselect elements that you already selected by clicking the element in the Graphics window again, but this time while pressing the CTRL key
- ▶ Alternative: Select the element in the List View window and press the **DEL** key
- ▶ Alternative: Click the icon to deselect all selected elements



- ▶ Save the selected machining positions to the clipboard of the control so that you can then insert them as a positioning block with cycle call in a Klartext program



- ▶ Alternative: Save the selected machining positions as a point file
- ▶ The control displays a pop-up window in which you can select the target directory, a file name, and the file type.



- ▶ Confirm the entry
- ▶ The control saves the contour program to the selected directory.





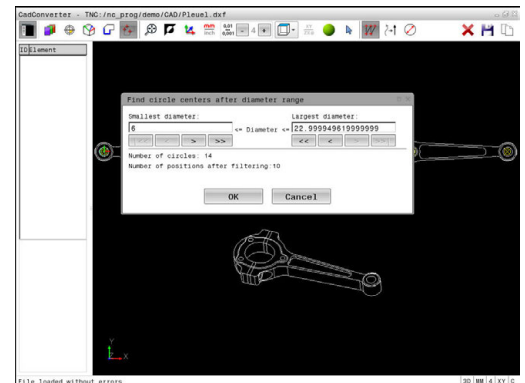

- ▶ If you want to select more machining positions, press the Cancel Selected Elements icon and select as described above







### Filter settings

After you have used the quick selection function to mark hole positions, a pop-up window appears in which the smallest diameter found is to the left and the largest diameter to the right. With the buttons just below the diameter display you can adjust the diameter so that you can load the hole diameters that you want.

The following buttons are available:

Icon	Filter setting of smallest diameter
	Display the smallest diameter found (default setting)
	Display the next smaller diameter found
	Display the next larger diameter found
	Display the largest diameter found. The control sets the filter for the smallest diameter to the value set for the largest diameter

Icon	Filter setting of largest diameter
	Display the smallest diameter found. The control sets the filter for the largest diameter to the value set for the smallest diameter
	Display the next smaller diameter found
	Display the next larger diameter found
	Display the largest diameter found (default setting)

You can have the tool paths displayed by clicking the **SHOW TOOL PATH** icon.

**Further information:** "Basic settings", page 327

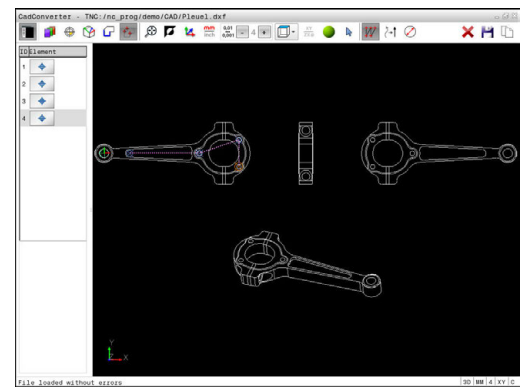
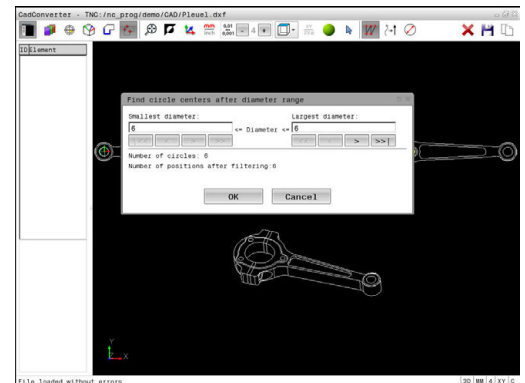

### Element information

In the Element Information window, the control displays the coordinates of the machining position that you last selected in the List View window or Graphics window by clicking on the mouse.

You can also use the mouse to change the graphic display. The following functions are available:

- ▶ To rotate the model shown in three dimensions, hold down the right mouse button and move the mouse
- ▶ To shift the model shown, hold the center mouse button or mouse wheel down and move the mouse
- ▶ To zoom in on a certain area, mark a zoom area by holding the left mouse button down
- > After you release the left mouse button, the control zooms in on the defined area.
- ▶ To rapidly magnify or reduce any area, rotate the mouse wheel backwards or forwards
- ▶ To return to the standard display, press the shift key and simultaneously double-click with the right mouse button. The rotation angle is maintained if you only double-click with the right mouse button

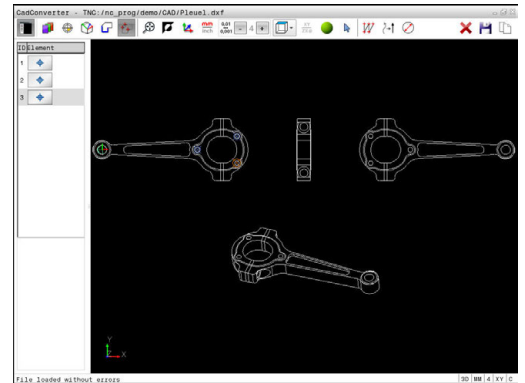





# 9

**Subprograms and  
Program Section  
Repeats**

## 9.1 Labeling subprograms and program section repeats

Subprograms and program section repeats enable you to program a machining sequence once and then run it as often as necessary.

### Label

The beginnings of subprograms and program section repeats are marked in a part program by labels (**LBL**).

A LABEL is identified by a number between 1 and 65535 or by a name you define. Each LABEL number or LABEL name can be set only once in the program with the **LABEL SET** key. The number of label names you can enter is only limited by the internal memory.



Do not use a label number or label name more than once!

Label 0 (**LBL 0**) is used exclusively to mark the end of a subprogram and can therefore be used as often as desired.

## 9.2 Subprograms

### Operating sequence

- 1 The control executes the part program up to the **CALL LBL** command for calling a subprogram
- 2 The subprogram is then executed until the subprogram end **LBL 0**
- 3 The control then resumes the part program from the block after the subprogram call **CALL LBL**

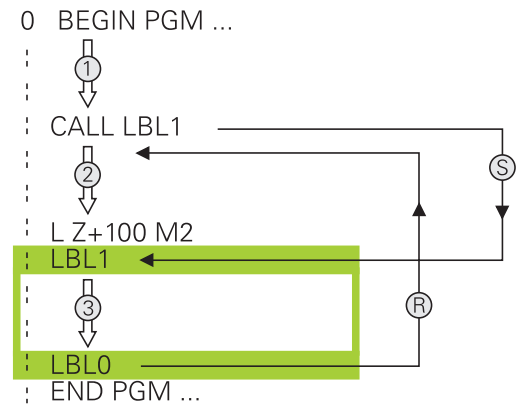

### Programming notes

- A main program can contain any number of subprograms
- You can call subprograms in any sequence and as often as desired
- A subprogram cannot call itself
- Write subprograms after the block with M2 or M30
- If subprograms are located before the block with M2 or M30 in the part program, they will be executed at least once even if they are not called

## Programming the subprogram

LBL  
SET

- ▶ To mark the beginning: Press the **LBL SET** key
- ▶ Enter the subprogram number. If you want to use a label name, press the **LBL NAME** soft key to switch to text entry.
- ▶ Enter the text
- ▶ Mark the end: Press the **LBL SET** key and enter the label number **0**

## Calling a subprogram

LBL  
CALL

- ▶ Call a subprogram: Press the **LBL CALL** key
- ▶ Enter the subprogram number of the subprogram you wish to call. If you want to use a label name, press the **LBL NAME** soft key to switch to text entry.
- ▶ If you want to enter the number of a string parameter as target address, press the QS soft key
- > The control then jumps to the label name that is specified in the string parameter defined.
- ▶ Ignore repeats **REP** by pressing the **NO ENT** key. Repeat **REP** is used only for program section repeats



**CALL LBL 0** is not permitted (Label 0 is only used to mark the end of a subprogram).

## 9.3 Program-section repeats

### Label

The beginning of a program section repeat is marked by the label **LBL**. The end of a program section repeat is identified by **CALL LBL n REPn**.

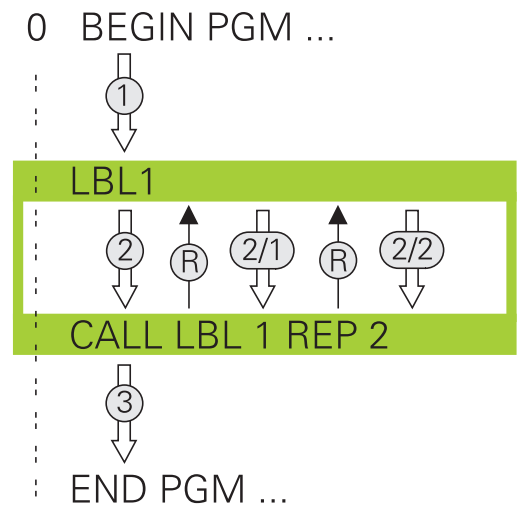

### Operating sequence

- 1 The control executes the part program up to the end of the program section (**CALL LBL n REPn**)
- 2 Then the program section between the called LABEL and the label call **CALL LBL n REPn** is repeated the number of times entered after **REP**
- 3 The control then continues with the part program

### Programming notes

- You can repeat a program section up to 65 534 times in succession
- The total number of times the program section is executed is always one more than the programmed number of repeats, because the first repeat starts after the first machining process.

## Programming a program section repeat

LBL  
SET

- ▶ To mark the beginning, press the **LBL SET** key and enter a LABEL NUMBER for the program section you wish to repeat. If you want to use a label name, press the **LBL NAME** soft key to switch to text entry.
- ▶ Enter the program section

## Calling a program section repeat

LBL  
CALL

- ▶ Call a program section: Press the **LBL CALL** key
- ▶ Enter the program section number of the program section to be repeated. If you want to use a LABEL name, press the **LBL NAME** soft key to switch to text entry
- ▶ Enter the number of repeats **REP** and confirm with the **ENT** key.

## 9.4 Any desired NC program as subprogram

### Overview of the soft keys

When you press the **PGM CALL** key, the control displays the following soft keys:

Soft key	Function
CALL PROGRAM	Call an NC program with <b>PGM CALL</b>
SELECT DATUM TABLE	Select a datum table with <b>SEL TABLE</b>
SELECT POINT TABLE	Select a point table with <b>SEL PATTERN</b>
SELECT CONTOUR	Select a contour program with <b>SEL CONTOUR</b>
SELECT PROGRAM	Select an NC program with <b>SEL PGM</b>
CALL SELECTED PROGRAM	Call the last selected file with <b>CALL SELECTED PGM</b>
SELECT CYCLE	Select any NC program with <b>SEL CYCLE</b> as a fixed cycle <b>Further information:</b> Cycle Programming User's Manual

## Operating sequence

- 1 The control executes the NC program up to the block in which another NC program is called with **CALL PGM**.
- 2 Then the control executes the called NC program up to the end of program
- 3 The control then resumes executing the calling NC program with the block after the program call



If you want to program variable program calls in connection with string parameters, use the **SEL PGM** function.

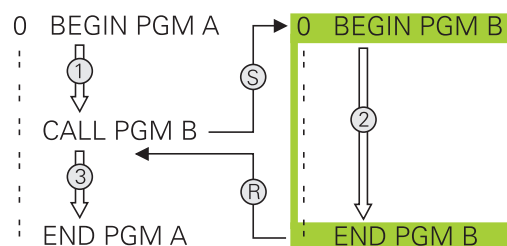

## Programming notes

- The control does not require any labels to call any part program
- The called NC program must not contain any **CALL PGM** call into the calling NC program (an endless loop ensues)
- The called NC program must not contain the miscellaneous functions **M2** or **M30**. If you have defined subprograms with labels in the called NC program, you can then replace M2 or M30 with the **FN 9: If +0 EQU +0 GOTO LBL 99** jump function

If the called NC program contains the miscellaneous functions **M2** or **M30**, then the control displays a warning. The control automatically clears the warning as soon as you select another NC program.



## Calling any program as a subprogram

### NOTICE

#### Danger of collision!

The control does not automatically check whether collisions can occur between the tool and the workpiece. If coordinate transformations are not specifically reset in called NC programs, then these transformation are likewise effective for the calling NC program. Danger of collision during machining!

- ▶ Reset coordinate transformations used in the same NC program
- ▶ Check the machining sequence using a graphic simulation if required



#### Programming notes:

- If the program you want to call is located in the same directory as the program you are calling it from, then you only need to enter the program name.
- If the program called is not located in the same directory as the calling program, you must enter the complete path, for example **TNC:\ZW35\HERE \PGM1.H**  
Alternatively, you can program relative paths:
  - Starting from the folder of the calling program one folder level up **..\PGM1.H**
  - Starting from the folder of the calling program one folder level down **DOWN\PGM1.H**
  - Starting from the folder of the calling program one folder level up and in one other folder **..\THERE \PGM3.H**
- If you want to call a DIN/ISO program, enter the file type **.I** after the program name.
- You can also call a program with Cycle **12 PGM CALL**.
- You can call any program by also using the function **Select the cycle (SEL CYCLE )**.
- As a rule, Q parameters are effective globally with a **PGM CALL**. So please note that changes to Q parameters in the called program also influence the calling program.

### Calling a program with PGM CALL

The **PGM CALL** function calls any program as a subprogram. The control runs the called program from the position where it was called in the program.

PGM  
CALL

- ▶ To select the functions for program call, press the **PGM CALL** key

CALL  
PROGRAM

- ▶ Press the **CALL PROGRAM** soft key
- > The control starts the dialog for defining the program to be called.
- ▶ Enter the path name with the keyboard

or

SELECT  
FILE



- ▶ Press the **SELECT FILE** soft key
- > The control shows a selection window that allows you to select the program to be called.
- ▶ Press the **ENT** key

### Calling a program with SEL PGM and CALL SELECTED PGM



Use the function **SEL PGM** to select any program as a subprogram and call it at another position in the program. The control runs the called program from the position where it was called in the program with **CALL SELECTED PGM**.

The **SEL PGM** function is also permitted with string parameters, so that you can dynamically control program calls.

To select the program, proceed as follows:

- 
  - ▶ To select the functions for program call, press the **PGM CALL** key
- 
  - ▶ Press the **SELECT PROGRAM** soft key
  - > The control starts the dialog for defining the program to be called.
- 
  - ▶ Press the **SELECT FILE** soft key
  - > The control shows a selection window that allows you to select the program to be called.
  - ▶ Press the **ENT** key

To call the selected program, proceed as follows:

- 
  - ▶ To select the functions for program call, press the **PGM CALL** key
- 
  - ▶ Press the **CALL SELECTED PROGRAM** soft key
  - > With **CALL SELECTED PGM**, the control calls the last program selected.



If an NC program that was called using **CALL SELECTED PGM** is missing, then the control interrupts the execution or simulation with an error message. In order to avoid undesired interruptions during program run, all paths to the program beginning can be checked using the **FN 18** function (**ID10 NR110** and **NR111**)  
**Further information:** "FN 18: SYSREAD – Reading system data", page 392

## 9.5 Nesting

### Types of nesting

- Subprogram calls in subprograms
- Program-section repeats within a program-section repeat
- Subprogram calls in program section repeats
- Program-section repeats in subprograms

### Nesting depth

The nesting depth is the number of successive levels in which program sections or subprograms can call further program sections or subprograms.

- Maximum nesting depth for subprograms: 19
- Maximum nesting depth for main program calls: 19, where a **CYCL CALL** acts like a main program call
- You can nest program section repeats as often as desired

## Subprogram within a subprogram

### Example

<b>0 BEGIN PGM UPGMS MM</b>	
...	
<b>17 CALL LBL "UP1"</b>	Call the subprogram marked with LBL SP1
...	
<b>35 L Z+100 R0 FMAX M2</b>	Last program block of the main program with M2
<b>36 LBL "UP1"</b>	Beginning of subprogram SP1
...	
<b>39 CALL LBL 2</b>	Call the subprogram marked with LBL 2
...	
<b>45 LBL 0</b>	End of subprogram 1
<b>46 LBL 2</b>	Beginning of subprogram 2
...	
<b>62 LBL 0</b>	End of subprogram 2
<b>63 END PGM SUBPGMS MM</b>	

### Program execution

- 1 Main program UPGMS is executed up to block 17.
- 2 Subprogram SP1 is called, and executed up to block 39.
- 3 Subprogram 2 is called, and executed up to block 62. End of subprogram 2 and return jump to the subprogram from which it was called.
- 4 Subprogram 1 is called, and executed from block 40 up to block 45. End of subprogram 1 and return jump to the main program UPGMS.
- 5 Main program UPGMS is executed from block 18 up to block 35. Return jump to block 1 and end of program.

## Repeating program section repeats

### Example

<b>0 BEGIN PGM REPS MM</b>	
...	
<b>15 LBL 1</b>	Beginning of program section repeat 1
...	
<b>20 LBL 2</b>	Beginning of program section repeat 2
...	
<b>27 CALL LBL 2 REP 2</b>	Program section call with two repeats
...	
<b>35 CALL LBL 1 REP 1</b>	The program section between this block and LBL 1
...	(block 15) is repeated once
<b>50 END PGM REPS MM</b>	

### Program execution

- 1 Main program REPS is executed up to block 27.
- 2 Program section between block 27 and block 20 is repeated twice.
- 3 Main program REPS is executed from block 28 to block 35.
- 4 Program section between block 35 and block 15 is repeated once (including the program section repeat between 20 and block 27).
- 5 Main program REPS is executed from block 36 to block 50. Return jump to block 1 and end of program.

## Repeating a subprogram

### Example

<b>0 BEGIN PGM UPGREP MM</b>	
...	
<b>10 LBL 1</b>	Beginning of program section repeat 1
<b>11 CALL LBL 2</b>	Subprogram call
<b>12 CALL LBL 1 REP 2</b>	Program section call with two repeats
...	
<b>19 L Z+100 RO FMAX M2</b>	Last block of the main program with M2
<b>20 LBL 2</b>	Beginning of subprogram
...	
<b>28 LBL 0</b>	End of subprogram
<b>29 END PGM UPGREP MM</b>	

### Program execution

- 1 Main program UPGREP is executed up to block 11.
- 2 Subprogram 2 is called and executed.
- 3 Program section between block 12 and block 10 is repeated twice. This means that subprogram 2 is repeated twice.
- 4 Main program UPGREP is executed from block 13 up to block 19. Return jump to block 1 and end of program.

## 9.6 Programming examples

### Example: Milling a contour in several infeeds

Program run:

- Pre-position the tool to the workpiece surface
- Enter the infeed depth in incremental values
- Contour milling
- Repeat infeed and contour-milling

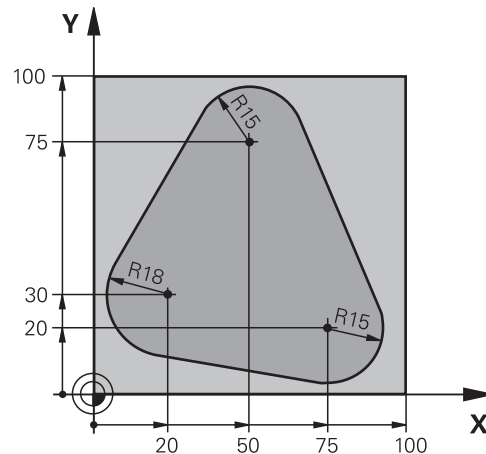

0 BEGIN PGM PGMWDH MM	
1 BLK FORM 0.1 Z X+0 Y+0 Z-40	
2 BLK FORM 0.2 X+100 Y+100 Z+0	
3 TOOL CALL 1 Z S500	Tool call
4 L Z+250 R0 FMAX	Retract the tool
5 L X-20 Y+30 R0 FMAX	Pre-position in the working plane
6 L Z+0 R0 FMAX M3	Pre-position to the workpiece surface
7 LBL 1	Set label for program section repeat
8 L IZ-4 R0 FMAX	Infeed depth in incremental values (in space)
9 APPR CT X+2 Y+30 CCA90 R+5 RL F250	Contour approach
10 FC DR- R18 CLSD+ CCX+20 CCY+30	Contour
11 FLT	
12 FCT DR- R15 CCX+50 CCY+75	
13 FLT	
14 FCT DR- R15 CCX+75 CCY+20	
15 FLT	
16 FCT DR- R18 CLSD- CCX+20 CCY+30	
17 DEP CT CCA90 R+5 F1000	Contour departure
18 L X-20 Y+0 R0 FMAX	Retract tool
19 CALL LBL 1 REP 4	Return jump to LBL 1; section is repeated a total of 4 times
20 L Z+250 R0 FMAX M2	Retract the tool, end program
21 END PGM PGMWDH MM	



### Example: Groups of holes

Program run:

- Approach the groups of holes in the main program
- Call the group of holes (subprogram 1) in the main program
- Program the group of holes only once in subprogram 1

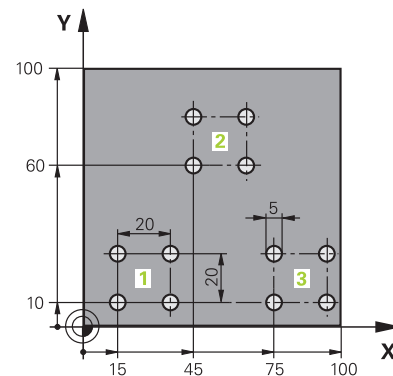

0 BEGIN PGM UP1 MM	
1 BLK FORM 0.1 Z X+0 Y+0 Z-20	
2 BLK FORM 0.2 X+100 Y+100 Z+0	
3 TOOL CALL 1 Z S5000	Tool call
4 L Z+250 R0 FMAX	Retract the tool
5 CYCL DEF 200 DRILLING	Cycle definition: drilling
Q200=2           ;SET-UP CLEARANCE	
Q201=-10       ;DEPTH	
Q206=250       ;FEED RATE FOR PLNGNG	
Q202=5          ;PLUNGING DEPTH	
Q210=0          ;DWELL TIME AT TOP	
Q203=+0         ;SURFACE COORDINATE	
Q204=10         ;2ND SET-UP CLEARANCE	
Q211=0.25       ;DWELL TIME AT DEPTH	
Q395=0          ;DEPTH REFERENCE	
6 L X+15 Y+10 R0 FMAX M3	Move to starting point for group 1
7 CALL LBL 1	Call the subprogram for the group
8 L X+45 Y+60 R0 FMAX	Move to starting point for group 2
9 CALL LBL 1	Call the subprogram for the group
10 L X+75 Y+10 R0 FMAX	Move to starting point for group 3
11 CALL LBL 1	Call the subprogram for the group
12 L Z+250 R0 FMAX M2	End of main program
13 LBL 1	Beginning of subprogram 1: Group of holes
14 CYCL CALL	Hole 1
15 L IX+20 R0 FMAX M99	Move to 2nd hole, call cycle
16 L IY+20 R0 FMAX M99	Move to 3rd hole, call cycle
17 L IX-20 R0 FMAX M99	Move to 4th hole, call cycle
18 LBL 0	End of subprogram 1
19 END PGM UP1 MM	

### Example: Group of holes with several tools

Program run:

- Program the fixed cycles in the main program
- Call the complete hole pattern (subprogram 1) in the main program
- Approach the groups of holes (subprogram 2) in subprogram 1
- Program the group of holes only once in subprogram 2

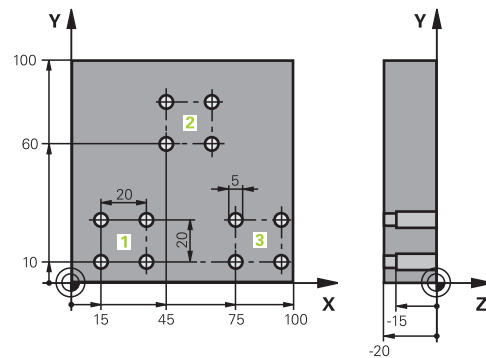

0 BEGIN PGM UP2 MM	
1 BLK FORM 0.1 Z X+0 Y+0 Z-20	
2 BLK FORM 0.2 X+100 Y+100 Z+0	
3 TOOL CALL 1 Z S5000	Centering drill tool call
4 L Z+250 R0 FMAX	Retract the tool
5 CYCL DEF 200 DRILLING	Cycle definition: CENTERING
Q200=2           ;SET-UP CLEARANCE	
Q201=-3         ;DEPTH	
Q206=250       ;FEED RATE FOR PLNGNG.	
Q202=3         ;PLUNGING DEPTH	
Q210=0         ;DWELL TIME AT TOP	
Q203=+0        ;SURFACE COORDINATE	
Q204=10        ;2ND SET-UP CLEARANCE	
Q211=0.25      ;DWELL TIME AT DEPTH	
Q395=0         ;DEPTH REFERENCE	
6 CALL LBL 1	Call subprogram 1 for the entire hole pattern
7 L Z+250 R0 FMAX	
8 TOOL CALL 2 Z S4000	Drill tool call
9 FN 0: Q201 = -25	New depth for drilling
10 FN 0: Q202 = +5	New plunging depth for drilling
11 CALL LBL 1	Call subprogram 1 for the entire hole pattern
12 L Z+250 R0 FMAX	
13 TOOL CALL 3 Z S500	Reamer tool call

<b>14 CYCL DEF 201 REAMING</b>	Cycle definition: REAMING
Q200=2           ;SET-UP CLEARANCE	
Q201=-15       ;DEPTH	
Q206=250       ;FEED RATE FOR PLNGNG.	
Q211=0.5       ;DWELL TIME AT DEPTH	
Q208=400       ;RETRACTION FEED RATE	
Q203=+0        ;SURFACE COORDINATE	
Q204=10        ;2ND SET-UP CLEARANCE	
<b>15 CALL LBL 1</b>	Call subprogram 1 for the entire hole pattern
<b>16 L Z+250 R0 FMAX M2</b>	End of main program
<b>17 LBL 1</b>	Beginning of subprogram 1: Entire hole pattern
<b>18 L X+15 Y+10 R0 FMAX M3</b>	Move to starting point for hole group 1
<b>19 CALL LBL 2</b>	Call subprogram 2 for the hole group
<b>20 L X+45 Y+60 R0 FMAX</b>	Move to starting point for hole group 2
<b>21 CALL LBL 2</b>	Call subprogram 2 for the hole group
<b>22 L X+75 Y+10 R0 FMAX</b>	Move to starting point for hole group 3
<b>23 CALL LBL 2</b>	Call subprogram 2 for the hole group
<b>24 LBL 0</b>	End of subprogram 1
<b>25 LBL 2</b>	Beginning of subprogram 2: Group of holes
<b>26 CYCL CALL</b>	1st hole with active fixed cycle
<b>27 L IX+20 R0 FMAX M99</b>	Move to 2nd hole, call cycle
<b>28 L IY+20 R0 FMAX M99</b>	Move to 3rd hole, call cycle
<b>29 L IX-20 R0 FMAX M99</b>	Move to 4th hole, call cycle
<b>30 LBL 0</b>	End of subprogram 2
<b>31 END PGM SP2 MM</b>	



# 10

**Programming  
Q Parameters**

## 10.1 Principle and overview of functions

With Q parameters you can program entire families of parts in a single NC program by programming variable Q parameters instead of fixed numerical values.

Use Q parameters for e.g.:

- Coordinate values
- Feed rates
- Spindle speeds
- Cycle data

With Q parameters you can also:

- Program contours that are defined through mathematical functions
- Make execution of machining steps depend on certain logical conditions
- Variably design FK programs

Q parameters are always identified with letters and numbers. The letters determine the type of Q parameter and the numbers the Q parameter range.

For more information, see the table below:

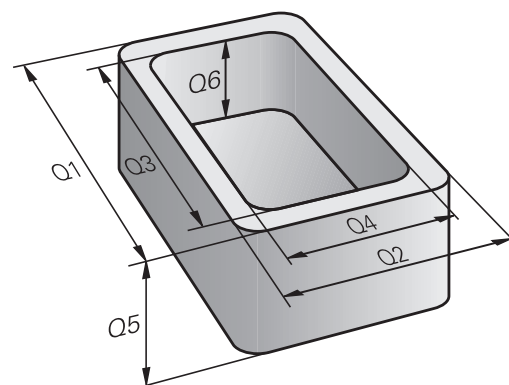

Q parameter type	Q parameter range	Meaning
<b>Q parameters:</b>		
	0 – 99	Parameters for the <b>user</b> , if there are no overlaps with the HEIDENHAIN-SL cycles
	100 – 199	Parameters for special functions on the control that can be read by NC programs of the user or by cycles
	200 – 1199	Parameters primarily used for HEIDENHAIN cycles
	1200 – 1399	Parameters that are primarily used with manufacturer cycles when values are given back to the user program
	1400 – 1599	Parameters primarily used as input parameters for manufacturer cycles
	1600 – 1999	Parameters for <b>users</b>
<b>QL parameters:</b>		
	0 – 499	Parameters for <b>users</b>
<b>QR parameters:</b>		
	0 to 99	Parameters for <b>users</b>
	100 to 199	Parameters for HEIDENHAIN functions (e.g., cycles)
	200 to 499	Parameters for the machine tool builder (e.g., cycles)

**QS** parameters (the **S** stands for string) are also available on the control and enable you to process texts.

Q parameter type	Q parameter range	Meaning
<b>QS</b> parameters:		<b>Parameters affect all NC programs in the control's</b> memory
	0 – 99	Parameters for the <b>user</b> , where no overlaps with the HEIDENHAIN SL cycles are present
	100 – 199	Parameters for special functions on the control that can be read by NC programs of the user or by cycles
	200 – 1199	Parameters primarily used for HEIDENHAIN cycles
	1200 – 1399	Parameters that are primarily used with manufacturer cycles when values are given back to the user program
	1400 – 1599	Parameters primarily used as input parameters for manufacturer cycles
	1600 – 1999	Parameters for <b>users</b>

### NOTICE

#### Danger of collision!

Q parameters are used in the HEIDENHAIN cycles, in machine tool builder cycles, and in supplier functions. You can also program Q parameters within the NC program. If, when using Q parameters, the recommended Q parameter ranges are not used exclusively, then this can lead to overlapping (reciprocal effects) and thus cause undesired behavior. Danger of collision during machining!

- ▶ Only use Q parameter ranges recommended by HEIDENHAIN.
- ▶ Comply with the documentation from HEIDENHAIN, the machine tool builder, and suppliers.
- ▶ Check the machining sequence using a graphic simulation

## Programming notes

You can mix Q parameters and numerical values within an NC program.

Q parameters can be assigned numerical values between -999 999 999 and +999 999 999. The input range is limited to 16 digits, of which 9 may be before the decimal point. Internally the control calculates numbers up to a value of  $10^{10}$ .

You can assign a maximum of 255 characters to **QS** parameters.



The control automatically assigns some Q and QS parameters the same data, e.g., the Q parameter **Q108** is automatically assigned the current tool radius.

**Further information:** " Preassigned Q parameters", page 456

The control saves numerical values internally in a binary number format (standard IEEE 754). Due to the standardized format used, the control does not represent some decimal numbers with a binary number that is 100% exact (round-off error). If you use calculated Q parameter contents for jump commands or positioning moves, then you must take this fact into consideration.

You can reset Q parameters to the status **Undefined**. If a position is programmed with a Q parameter that is undefined, the control ignores this movement.



## Calling Q parameter functions

When you are writing a part program, press the **Q** key (in the numeric keypad for numerical input and axis selection, below the +/- key). The control then displays the following soft keys:

Soft key	Function group	Page
BASIC ARITHM.	Basic arithmetic (assign, add, subtract, multiply, divide, square root)	371
TRIGO- NOMETRY	Trigonometric functions	374
CIRCLE CALCU- LATION	Function for calculating circles	375
JUMP	If/then conditions, jumps	376
DIVERSE FUNCTION	Other functions	380
FORMULA	Entering formulas directly	439
CONTOUR FORMULA	Function for machining complex contours	See Cycle Programming User's Manual



If you define or assign a Q parameter, then the control shows the **Q**, **QL** and **QR** soft keys. You can use these soft keys to select the desired parameter type. Then you define the parameter number.

If you have a USB keyboard connected, you can press the **Q** key to open the dialog for entering a formula.

## 10.2 Part families—Q parameters in place of numerical values

### Application

The Q parameter function **FN O: ASSIGN** assigns numerical values to Q parameters. This enables you to use variables in the program instead of fixed numerical values.

### Example

15 FN O: Q10=25	Assign
...	Q10 is assigned the value 25
25 L X +Q10	Means L X +25

You need write only one program for a whole family of parts, entering the characteristic dimensions as Q parameters.

To program a particular part, you then assign the appropriate values to the individual Q parameters.

### Example: Cylinder with Q parameters

Cylinder radius:	$R = Q1$
Cylinder height:	$H = Q2$
Cylinder Z1:	$Q1 = +30$ $Q2 = +10$
Cylinder Z2:	$Q1 = +10$ $Q2 = +50$

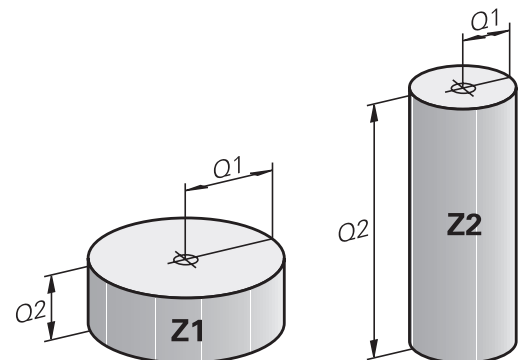

## 10.3 Describing contours with mathematical functions

### Application

The Q parameters listed below enable you to program basic mathematical functions in a machining program:

- ▶ Select a Q parameter function: Press the **Q** key (in the numerical keypad on the right). The Q parameter functions are displayed in a soft key row
- ▶ To select the basic mathematical functions, press the **BASIC ARITHM...** soft key.
- > The control then displays the following soft keys:

### Overview

Soft key	Function
<div style="border: 1px solid black; padding: 2px; width: fit-content;">           FN0 x = y         </div>	<b>FN 0: ASSIGN</b> e. g., <b>FN 0: Q5 = +60</b> Directly assign value Reset Q parameter value
<div style="border: 1px solid black; padding: 2px; width: fit-content;">           FN1 x + y         </div>	<b>FN 1: ADDITION</b> e. g., <b>FN 1: Q1 = -Q2 + -5</b> Calculate and assign the sum of two values
<div style="border: 1px solid black; padding: 2px; width: fit-content;">           FN2 x - y         </div>	<b>FN 2: SUBTRACTION</b> e. g. <b>FN 2: Q1 = +10 - +5</b> Form and assign difference between two values
<div style="border: 1px solid black; padding: 2px; width: fit-content;">           FN3 x * y         </div>	<b>FN 3: MULTIPLICATION</b> e. g. <b>FN 3: Q2 = +3 * +3</b> Form and assign the product of two values
<div style="border: 1px solid black; padding: 2px; width: fit-content;">           FN4 x / y         </div>	<b>FN 4: DIVISION</b> e.g., <b>FN 4: Q4 = +8 DIV +Q2</b> Calculate and assign the quotient of two values <b>Not permitted:</b> Division by 0
<div style="border: 1px solid black; padding: 2px; width: fit-content;">           FN5 SQRT         </div>	<b>FN 5: SQUARE ROOT</b> e.g., <b>FN 5: Q20 = SQRT 4</b> Calculate and assign the square root of a value <b>Not permitted:</b> Square root of a negative value

You can enter the following to the right of the = sign:

- Two numbers
- Two Q parameters
- A number and a Q parameter

The Q parameters and numerical values in the equations can be entered with positive or negative signs.

## Programming fundamental operations

### Example 1

#### Example

16 FN 0: Q5 = +10

17 FN 3: Q12 = +Q5 \* +7



- ▶ Select the Q parameter function: Press the **Q** key



- ▶ To select the mathematical functions, press the **BASIC ARITHM.** soft key.



- ▶ Select the ASSIGN Q parameter function: Press the **FN0 X = Y** soft key

#### PARAMETER NUMBER FOR RESULT?



- ▶ Enter **5** (the number of the Q parameter) and confirm with the **ENT** key

#### FIRST VALUE / PARAMETER?



- ▶ Enter **10**: Assign the numerical value 10 to Q5 and confirm with the **ENT** key

### Example 2



- ▶ Select the Q parameter function: Press the **Q** key



- ▶ To select the mathematical functions, press the **BASIC ARITHM.** soft key.



- ▶ To select the MULTIPLICATION Q parameter function, press the **FN3 X \* Y** soft key

#### PARAMETER NUMBER FOR RESULT?



- ▶ Enter **12** (the number of the Q parameter) and confirm with the **ENT** key

#### FIRST VALUE / PARAMETER?



- ▶ Enter **Q5** as the first value and confirm with the **ENT** key.

#### SECOND VALUE / PARAMETER?



- ▶ Enter **7** as the second value and confirm with the **ENT** key.

**Example 3 – Reset Q parameters**

**Example**

16 FN 0: Q5 SET UNDEFINED

17 FN 0: Q1 = Q5



▶ Select the Q parameter function: Press the **Q** key



▶ To select the mathematical functions, press the **BASIC ARITHM.** soft key.



▶ Select the ASSIGN Q parameter function: Press the **FN0 X = Y** soft key

**PARAMETER NUMBER FOR RESULT?**



▶ Enter **5** (the number of the Q parameter) and confirm with the **ENT** key

**1. VALUE OR PARAMETER?**



▶ Press **SET UNDEFINED**



The **FN 0** function also supports transfer of the value **Undefined**. If you wish to transfer the undefined Q parameter without **FN 0**, the control shows the error message **Invalid value**.

## 10.4 Angle functions

### Definitions

**Sine:**  $\sin \alpha = a / c$

**Cosine:**  $\cos \alpha = b / c$

**Tangent:**  $\tan \alpha = a / b = \sin \alpha / \cos \alpha$

where

- c is the side opposite the right angle
- a is the side opposite the angle  $\alpha$
- b is the third side.

The control can find the angle from the tangent:

$$\alpha = \arctan (a / b) = \arctan (\sin \alpha / \cos \alpha)$$

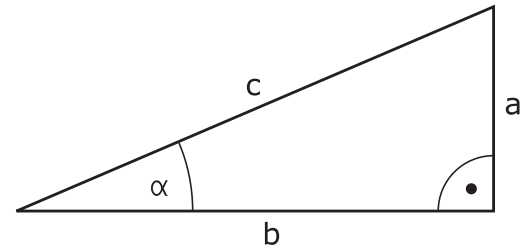

### Example:

a = 25 mm

b = 50 mm

$$\alpha = \arctan (a / b) = \arctan 0.5 = 26.57^\circ$$

Furthermore:

$$a^2 + b^2 = c^2 \text{ (where } a^2 = a \times a \text{)}$$

$$c = \sqrt{a^2 + b^2}$$

### Programming trigonometric functions

Press the **TRIGONOMETRY** soft key to call the trigonometric functions. The control then displays the soft keys listed in the table below:

Soft key	Function
<div style="border: 1px solid black; padding: 2px; width: fit-content;">           FN6 SIN(X)         </div>	<b>FN 6: SINUS</b> e. g., <b>FN 6: Q20 = SIN-Q5</b> Calculate and assign the sine of an angle in degrees (°)
<div style="border: 1px solid black; padding: 2px; width: fit-content;">           D7 COS(X)         </div>	<b>FN 7: COSINE</b> e. g., <b>FN 7: Q21 = COS-Q5</b> Calculate and assign the cosine of an angle in degrees (°)
<div style="border: 1px solid black; padding: 2px; width: fit-content;">           FN8 X LEN Y         </div>	<b>FN 8: ROOT SUM OF SQUARES</b> e. g., <b>FN 8: Q10 = +5 LEN +4</b> Calculate and assign lengths from two values
<div style="border: 1px solid black; padding: 2px; width: fit-content;">           FN13 X ANG Y         </div>	<b>FN 13: ANGLE</b> e. g., <b>FN 13: Q20 = +25 ANG-Q1</b> Calculate and assign an angle with the arc tangent from the opposite and adjacent sides or with the sine and cosine of the angle ( $0 < \text{angle} < 360^\circ$ )

## 10.5 Calculation of circles

### Application

The control can use the functions for calculating circles to calculate the circle center and the circle radius from three or four given points on the circle. The calculation is more accurate if four points are used.

Application: These functions can be used, for example, if you wish to determine the location and size of a hole or a pitch circle using the programmable probing function.

Soft key	Function
	FN 23: Determining the CIRCLE DATA from three points e. g., <b>FN 23: Q20 = CDATA Q30</b>

The coordinate pairs of three points on a circle must be saved in Q30 and the following five parameters—in this case, up to Q35.

The control then saves the circle center in the reference axis (X if spindle axis is Z) in parameter Q20, the circle center in the minor axis (Y if spindle axis is Z) in parameter Q21, and the circle radius in parameter Q22.

Soft key	Function
	FN 24: Determining the CIRCLE DATA from four points e. g., <b>FN 24: Q20 = CDATA Q30</b>

The coordinate pairs of four points on a circle must be saved in Q30 and the following seven parameters—in this case, up to Q37.

The control then saves the circle center in the reference axis (X if spindle axis is Z) in parameter Q20, the circle center in the minor axis (Y if spindle axis is Z) in parameter Q21, and the circle radius in parameter Q22.



Note that **FN 23** and **FN 24** automatically overwrite the resulting parameter and the two following parameters.

## 10.6 If-then decisions with Q parameters

### Application

The control can make logical if-then decisions by comparing a Q parameter with another Q parameter or with a numerical value. If the condition is fulfilled, the control continues the program at the label that is programmed after the condition.

**Further information:** "Labeling subprograms and program section repeats", page 346

If it is not fulfilled, then the control executes the next block.

To call another program as a subprogram, enter a **PGM CALL** program call after the block with the label.

### Unconditional jumps

An unconditional jump is programmed by entering a conditional jump whose condition is always true. Example:

**FN 9: IF+10 EQU+10 GOTO LBL1**

### Abbreviations used:

<b>IF</b>	:	If
<b>EQU</b>	:	Equal to
<b>NE</b>	:	Not equal to
<b>GT</b>	:	Greater than
<b>LT</b>	:	Less than
<b>GOTO</b>	:	Go to
<b>UNDEFINED</b>	:	Undefined
<b>DEFINED</b>	:	Defined



## Programming if-then decisions

### Possibilities for jump inputs

The following inputs are possible for the condition **IF**:

- Numbers
- Texts
- Q, QL, QR
- **QS** (string parameter)

You have three possibilities for entering the jump address **GOTO**:

- **LBL NAME**
- **LBL NUMBER**
- **QS**

Press the **JUMP** soft key to call the if-then conditions. The control then displays the following soft keys:

Soft key	Function
<div style="border: 1px solid black; padding: 2px; width: fit-content;">                     FNS IF X EQ Y GOTO                 </div>	<b>FN 9: IF EQUAL, JUMP</b> e. g. <b>FN 9: IF +Q1 EQU +Q3 GOTO LBL "UPCAN25"</b>
<div style="border: 1px solid black; padding: 2px; width: fit-content;">                     EQU                 </div>	If both values or parameters are equal, jump to specified label
<div style="border: 1px solid black; padding: 2px; width: fit-content;">                     FNS IF X EQ Y GOTO                 </div>	<b>FN 9: IF UNDEFINED, JUMP</b> e. g., <b>FN 9: IF +Q1 IS UNDEFINED GOTO LBL "UPCAN25"</b>
<div style="border: 1px solid black; padding: 2px; width: fit-content;">                     IS UNDEFINED                 </div>	If the specified parameter is undefined, then a jump is made to the specified label
<div style="border: 1px solid black; padding: 2px; width: fit-content;">                     FNS IF X EQ Y GOTO                 </div>	<b>FN 9: IF DEFINED, JUMP</b> e. g., <b>FN 9: IF +Q1 IS DEFINED GOTO LBL "UPCAN25"</b>
<div style="border: 1px solid black; padding: 2px; width: fit-content;">                     IS DEFINED                 </div>	If the specified parameter is defined, then a jump is made to the specified label
<div style="border: 1px solid black; padding: 2px; width: fit-content;">                     FN10 IF X NE Y GOTO                 </div>	<b>FN 10: IF UNEQUAL, JUMP</b> e. g. <b>FN 10: IF +10 NE -Q5 GOTO LBL 10</b> If both values or parameters are unequal, jump to specified label
<div style="border: 1px solid black; padding: 2px; width: fit-content;">                     FN11 IF X GT Y GOTO                 </div>	<b>FN 11: IF GREATER, JUMP</b> g. g. <b>FN 11: IF+Q1 GT+10 GOTO LBL QS5</b> If the first value or parameter is greater than the second value or parameter, jump to specified label
<div style="border: 1px solid black; padding: 2px; width: fit-content;">                     FN12 IF X LT Y GOTO                 </div>	<b>FN 12: IF LESS, JUMP</b> e. g. <b>FN 12: IF+Q5 LT+0 GOTO LBL "ANYNAME"</b> If the first value or parameter is smaller than the second value or parameter, jump to specified label

## 10.7 Checking and changing Q parameters

### Procedure

You can check Q parameters in all operating modes, and also edit them.

- ▶ If you are in a program run, interrupt it if required (e.g., by pressing the **NC STOPP** key and the **INTERNAL STOP** soft key), or stop the test run

- Q**  
INFO
- ▶ To call the Q parameter functions, press the **Q INFO** soft key or the **Q** key
  - ▶ The control lists all of the parameters and their corresponding current values.
  - ▶ Use the arrow keys or the **GOTO** key to select the desired parameter.
  - ▶ If you would like to change the value, press the **EDIT CURRENT FIELD** soft key. Enter a new file name and confirm with **ENT**
  - ▶ To leave the value unchanged, press the **PRESENT VALUE** soft key or end the dialog with the **END** key



All of the parameters with displayed comments are used by the control within cycles or as transfer parameters. If you want to check or edit local, global or string parameters, press the **SHOW PARAMETERS Q QL QR QS** soft key. The control then displays the specific parameter type. The functions previously described also apply.

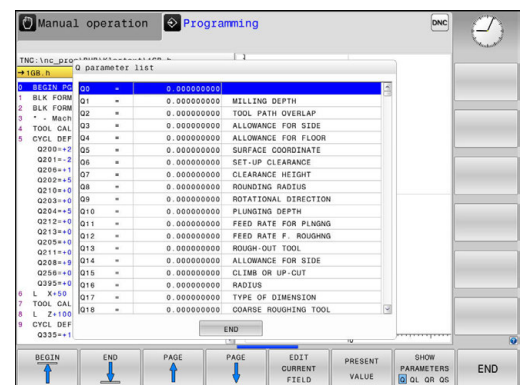
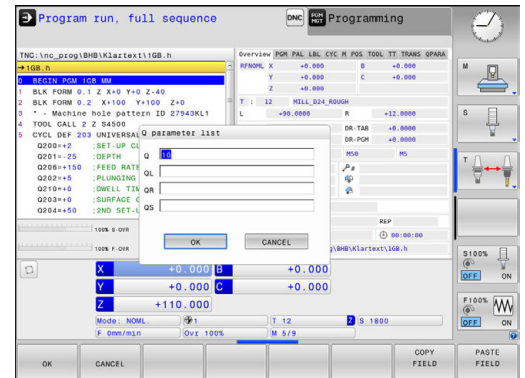

You can have Q parameters also displayed in the additional status display in all operating modes (except **Programming** mode).

- ▶ If you are in a program run, interrupt it if required (e.g. by pressing the **NC-STOPP** key and the **INTERNAL STOP** soft key), or stop the test run



- ▶ Call the soft key row for screen layout



- ▶ Select the layout option for the additional status display
- In the right half of the screen, the control shows the **Overview** status form.

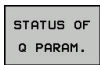

- ▶ Press the **STATUS OF Q PARAM.** soft key



- ▶ Press the **Q PARAMETER LIST** soft key.
- The control opens a pop-up window.
- ▶ For each parameter type (Q, QL, QR, QS), define the parameter numbers you wish to control. Separate single Q parameters with a comma, and connect sequential Q parameters with a hyphen, e.g. 1,3,200-208. The input range per parameter type is 132 characters



The display in the **QPARA** tab always contains eight decimal places. The result of  $Q1 = \text{COS } 89.999$  is shown by the control as 0.00001745, for example. Very large or very small values are displayed by the control in exponential notation. The result of  $Q1 = \text{COS } 89.999 * 0.001$  is shown by the control as +1.74532925e-08, whereby e-08 corresponds to the factor of  $10^{-8}$ .

## 10.8 Additional functions

### Overview

Press the **DIVERSE FUNCTION** soft key to call the additional functions. The control then displays the following soft keys:

Soft key	Function	Page
FN14 ERROR=	<b>FN 14: ERROR</b> Display error messages	381
FN16 F-PRINT	<b>FN 16: F-PRINT</b> Formatted output of texts or Q parameter values	385
FN18 SYS-DATUM READ	<b>FN 18: SYSREAD</b> Read system data	392
FN19 PLC=	<b>FN 19: PLC</b> Transfer values to the PLC	421
FN20 WAIT FOR	<b>FN 20: WAIT FOR</b> NC and PLC synchronization	422
FN26 OPEN TABLE	<b>FN 26: TABOPEN</b> Open a freely definable table	521
FN27 WRITE TO TABLE	<b>FN 27: TABWRITE</b> Write to a freely definable table	522
FN28 READ FROM TABLE	<b>FN 28: TABREAD</b> Read from a freely definable table	523
FN29 PLC LIST=	<b>FN 29: PLC</b> Transfer up to eight values to the PLC	423
FN37 EXPORT	<b>FN 37: EXPORT</b> Export local Q parameters or QS parameters into a calling program	424
FN38 SEND	<b>FN 38: SEND</b> Send information from the NC program	424

## FN 14: ERROR: Displaying error messages

With the **FN 14: ERROR** error function, you can output error messages under program control. The messages are predefined by the machine tool builder or by HEIDENHAIN. If, during a program run or test run, the control encounters a block with **FN 14: ERROR**, then the control will interrupt the program run or test run and display an error message. The program must then be restarted.

Error numbers area	Standard dialog
0 ... 999	Machine-dependent dialog
1000 ... 1199	Internal error messages

### Example

The control is intended to display a message if the spindle is not switched on.

**180 FN 14: ERROR = 1000**

### Error message predefined by HEIDENHAIN

Error number	Text
1000	Spindle?
1001	Tool axis is missing
1002	Tool radius too small
1003	Tool radius too large
1004	Range exceeded
1005	Start position incorrect
1006	ROTATION not permitted
1007	SCALING FACTOR not permitted
1008	MIRROR IMAGE not permitted
1009	Datum shift not permitted
1010	Feed rate is missing
1011	Input value incorrect
1012	Incorrect sign
1013	Entered angle not permitted
1014	Touch point inaccessible
1015	Too many points
1016	Contradictory input
1017	CYCL incomplete
1018	Plane wrongly defined
1019	Wrong axis programmed
1020	Wrong rpm
1021	Radius comp. undefined

<b>Error number</b>	<b>Text</b>
1022	Rounding-off undefined
1023	Rounding radius too large
1024	Program start undefined
1025	Excessive nesting
1026	Angle reference missing
1027	No fixed cycle defined
1028	Slot width too small
1029	Pocket too small
1030	Q202 not defined
1031	Q205 not defined
1032	Q218 must be greater than Q219
1033	CYCL 210 not permitted
1034	CYCL 211 not permitted
1035	Q220 too large
1036	Q222 must be greater than Q223
1037	Q244 must be greater than 0
1038	Q245 must not equal Q246
1039	Angle range must be under 360°
1040	Q223 must be greater than Q222
1041	Q214: 0 not permitted
1042	Traverse direction not defined
1043	No datum table active
1044	Position error: center in axis 1
1045	Position error: center in axis 2
1046	Hole diameter too small
1047	Hole diameter too large
1048	Stud diameter too small
1049	Stud diameter too large
1050	Pocket too small: rework axis 1
1051	Pocket too small: rework axis 2
1052	Pocket too large: scrap axis 1
1053	Pocket too large: scrap axis 2
1054	Stud too small: scrap axis 1
1055	Stud too small: scrap axis 2
1056	Stud too large: rework axis 1
1057	Stud too large: rework axis 2

<b>Error number</b>	<b>Text</b>
1058	TCHPROBE 425: length exceeds max
1059	TCHPROBE 425: length below min
1060	TCHPROBE 426: length exceeds max
1061	TCHPROBE 426: length below min
1062	TCHPROBE 430: diameter too large
1063	TCHPROBE 430: diameter too small
1064	No measuring axis defined
1065	Tool breakage tolerance exceeded
1066	Enter Q247 unequal to 0
1067	Enter Q247 greater than 5
1068	Datum table?
1069	Enter Q351 unequal to 0
1070	Thread depth too large
1071	Missing calibration data
1072	Tolerance exceeded
1073	Block scan active
1074	ORIENTATION not permitted
1075	3-D ROT not permitted
1076	Activate 3-D ROT
1077	Enter depth as negative
1078	Q303 in meas. cycle undefined!
1079	Tool axis not allowed
1080	Calculated values incorrect
1081	Contradictory meas. points
1082	Incorrect clearance height
1083	Contradictory plunge type
1084	This fixed cycle not allowed
1085	Line is write-protected
1086	Oversize greater than depth
1087	No point angle defined
1088	Contradictory data
1089	Slot position 0 not allowed
1090	Enter an infeed not equal to 0
1091	Switchover of Q399 not allowed
1092	Tool not defined
1093	Tool number not permitted

<b>Error number</b>	<b>Text</b>
1094	Tool name not permitted
1095	Software option not active
1096	Kinematics cannot be restored
1097	Function not permitted
1098	Contradictory workpc. blank dim.
1099	Measuring position not allowed
1100	Kinematic access not possible
1101	Meas. pos. not in traverse range
1102	Preset compensation not possible
1103	Tool radius too large
1104	Plunging type is not possible
1105	Plunge angle incorrectly defined
1106	Angular length is undefined
1107	Slot width is too large
1108	Scaling factors not equal
1109	Tool data inconsistent



## FN16: F-PRINT – Formatted output of texts and Q parameter values



With **FN 16: F-PRINT**, you can output any messages from your NC program on the screen. The control displays such messages in a pop-up window.

**Further information:** "Displaying messages on the control's screen", page 390

With the function **FN 16: F-PRINT**, you can save Q parameter values and output formatted texts (e.g. in order to save measurement reports). If you output the values, then the control saves the data in the file that you define in the **FN 16** block. The maximum size of the output file is 20 kB.

To be able to use the function **FN 16: F-PRINT**, first program a text file that specifies the output format.

### Available functions

Use the following formatting functions for creating a text file:

Special characters	Function
"....."	Define output format for texts and variables between the quotation marks
<b>%9.3F</b>	Format for Q parameter: <ul style="list-style-type: none"> <li>■ Define %: format</li> <li>■ 9.3: Total of 9 characters (incl. decimal point), of which 3 are decimal places</li> <li>■ F: Floating (decimal number), format for Q, QL, QR</li> </ul>
<b>%+7.3F</b>	Format for Q parameter: <ul style="list-style-type: none"> <li>■ Define %: format</li> <li>■ +: number right-aligned</li> <li>■ 7.3: Total of 7 characters (incl. decimal point), of which 3 are decimal places</li> <li>■ F: Floating (decimal number), format for Q, QL, QR</li> </ul>
<b>%S</b>	Format for text variable QS
<b>%D</b> or <b>%I</b>	Format for integer
,	Separation character between output format and parameter
;	End of block character
\n	Line break
+	Q parameter value, right-aligned
-	Q parameter value, left-aligned

The following functions allow you to include the following additional information in the protocol log file:

<b>Keyword</b>	<b>Function</b>
CALL_PATH	Indicates the path for the NC program where you will find the FN16 function. Example: "Measuring program: %S",CALL_PATH;
M_CLOSE	Closes the file to which you are writing with FN16. Example: M_CLOSE;
M_APPEND	Upon renewed output, appends the log to the existing log. Example: M_APPEND;
M_APPEND_MAX	Upon renewed output, appends the log to the existing log until the maximum specified file size in kilobytes is exceeded. Example: M_APPEND_MAX20;
M_TRUNCATE	Overwrites the log upon renewed output. Example: M_TRUNCATE;
L_ENGLISH	Outputs text only for English conversational language
L_GERMAN	Outputs text only for German conversational language
L_CZECH	Outputs text only for Czech conversational language
L_FRENCH	Outputs text only for French conversational language
L_ITALIAN	Outputs text only for Italian conversational language
L_SPANISH	Outputs text only for Spanish conversational language
L_PORTUGUESE	Outputs text only for Portuguese conversational language
L_SWEDISH	Outputs text only for Swedish conversational language
L_DANISH	Outputs text only for Danish conversational language
L_FINNISH	Outputs text only for Finnish conversational language
L_DUTCH	Outputs text only for Dutch conversational language
L_POLISH	Outputs text only for Polish conversational language
L_HUNGARIA	Outputs text only for Hungarian conversational language
L_CHINESE	Outputs text only for Chinese conversational language
L_CHINESE_TRAD	Outputs text only for Chinese (traditional) conversational language

<b>Keyword</b>	<b>Function</b>
L_SLOVENIAN	Outputs text only for Slovenian conversational language
L_NORWEGIAN	Outputs text only for Norwegian conversational language
L_ROMANIAN	Outputs text only for Romanian conversational language
L_SLOVAK	Outputs text only for Slovakian conversational language
L_TURKISH	Outputs text only for Turkish conversational language
L_ALL	Display text independently of the conversational language
HOUR	Number of hours from the real-time clock
MIN	Number of minutes from the real-time clock
SEC	Number of seconds from the real-time clock
DAY	Day from the real-time clock
MONTH	Month as a number from the real-time clock
STR_MONTH	Month as a string abbreviation from the real-time clock
YEAR2	Two-digit year from the real-time clock
YEAR4	Four-digit year from the real-time clock

### Creating a text file

To output the formatted texts and Q-parameter values, create a text file with the control's text editor. In this file you then define the output format and Q parameters you want to output. Create this file with the extension **.A**.

Example of a text file to define the output format:

```

"MEASURING LOG OF IMPELLER CENTER OF GRAVITY";
"DATE: %02d.%02d.%04d",DAY,MONTH,YEAR4;
"TIME: %02d:%02d:%02d",HOUR,MIN,SEC;
"NO. OF MEASURED VALUES: = 1";
"X1 = %9.3F", Q31;
"Y1 = %9.3F", Q32;
"Z1 = %9.3F", Q33;

```

### In the NC program, program FN 16: F-PRINT to activate the output:

Enter the path of the source and the path of the output file in the FN 16 function .

Specify the output file containing the output texts within the function **FN16**. The control generates the output file at the end of program (**END PGM**), at program abortion (**NC-STOPP** key) or via **M\_CLOSE** command.



If you only specify the file name as the path name of the log file, then the control saves the log file in the directory of the NC program with the **FN16** function.

Program relative paths as an alternative to complete paths:

- Starting from the folder of the calling file one folder level down **FN 16: F-PRINT MASKE\MASKE1.A/\PROT\PROT1.TXT**
- Starting from the folder of calling file one folder level up and in another folder **FN 16: F-PRINT ..\MASKE\MASKE1.A/..\PROT1.TXT**

### Example

```
96 FN 16: F-PRINT TNC:\MASK\MASK1.A/ TNC:\PROT1.TXT
```

The control then creates the file PROT1.TXT:

**MEASURING LOG OF IMPELLER CENTER OF GRAVITY**

**DATE: July 15, 2015**

**TIME: 8:56:34 AM**

**NO. OF MEASURED VALUES : = 1**

**X1 = 149.360**

**Y1 = 25.509**

**Z1 = 37.000**



## Operating and programming notes:

- If you output the same file multiple times in the program, then, within the target file, the control adds the current output after the previously output contents.
- In the **FN16** block, program the format file and the log file with their respective file type extensions.
- The file name extension of the log file determines the file format of the output (e.g., TXT, .A, .XLS, .HTML).
- In machine parameters **fn16DefaultPath** (no. 102202) and **fn16DefaultPathSim** (no. 102203) you can define a default path for outputting log files.
- If you use **FN16** the file must not be UTF8-encoded.
- You receive a great deal of relevant and interesting information for a log file by means of the function **FN 18** (e.g., the number of the last touch probe cycle used).

**Further information:** "FN 18: SYSREAD – Reading system data", page 392

### Displaying messages on the control's screen

You can also use the function **FN16: F-PRINT** to display any messages from the NC program in a pop-up window on the control's screen. This makes it easy to display explanatory texts, including long texts, at any point in the program in a way that the user has to react to them. You can also display Q-parameter contents if the protocol description file contains such instructions. For the message to appear on the control's screen, you need only enter **screen:** as the name of the protocol file.

#### Example

```
96 FN 16: F-PRINT TNC:\MASK\MASK1.A/screen:
```

If the message has more lines than fit in the pop-up window, you can use the arrow keys to page in the window.

To close the pop-up window, press the **CE** key. To have the program close the window, program the following NC block:

#### Example

```
96 FN 16: F-PRINT TNC:\MASK\MASK1.A/SCLR:
```



If you output the same file multiple times in the program, then, within the target file, the control adds the current output after the previously output contents.

### Exporting messages

The **FN 16** function also enables you to save the log files externally. Enter the complete target path in the **FN 16** function:

#### Example

```
96 FN 16: F-PRINT TNC:\MSK\MSK1.A / PC325:\LOG\PRO1.TXT
```



If you output the same file multiple times in the program, then, within the target file, the control adds the current output after the previously output contents.

### Entering the source or the target with parameters

You can enter the source file and the output file as Q parameters or as QS parameters. For this purpose you previously define the desired parameter in the NC program.

**Further information:** "Assign string parameters", page 444

In order for the control to recognize that you are working with Q parameters, enter them in the **FN16**-function with the following syntax:

Input	Function
<b>:'QS1'</b>	Set the QS parameter with preceding colon and between single quotation marks
<b>:'QL3'.txt</b>	Specify additional file name extension for the target file if required

**Printing messages**

You can also use the function **FN16: F-PRINT** to print any messages on a connected printer.

**Further information:** "Printer", page 107

In order for the messages to be sent to the printer, you must enter **Printer:\** as the name of the log file and then enter the corresponding file name.

The control saves the file in the **PRINTER:** path until the file is printed.

**Example**

```
96 FN 16: F-PRINT TNC:\MASKE\MASKE1.A/PRINTER:\DRUCK1
```

## FN 18: SYSREAD – Reading system data

With the **FN 18: SYSREAD** function you can read system data and store them in Q parameters. The selection of the system datum occurs via a group number (ID no.), a system data number, and, if necessary, an index.



The read values of the function **FN 18: SYSREAD** are always output by the control in **metric** units regardless of the NC program's unit of measure.



The following is a complete list of the **FN 18: SYSREAD** function. Please be aware that not all functions are available depending on the model of your control.

Group name	Gruppen-nummerID	Systemdaten-nummer	Index	Description
<b>Program information</b>				
	10	3	-	Number of the active machining cycle
		6	-	Number of the most recently executed touch probe cycle -1 = None
		7	-	Type of calling NC program: -1 = None 0 = Visible NC program 1 = Cycle/macro, main program is visible 2 = Cycle/macro, there is no visible main program
		103	Q parameter number	Relevant within NC cycles; for inquiry as to whether the Q parameter given under IDX was explicitly stated in the associated CYCLE DEF.
		110	QS parameter number	Is there a file with the name QS(IDX)? 0 = No, 1 = Yes This function eliminates relative file paths.
		111	QS parameter number	Is there a directory with the name QS(IDX)? 0 = no, 1 = Yes Only absolute directory paths are possible.



Group name	Gruppen-nummerID	Systemdaten-nummer	Index	Description
<b>Branch addresses of the system</b>				
	13	1	-	Label jumped to during M2/M30 instead of ending the current program. Value = 0: M2/M30 have the normal effect
		2	-	Label jumped to in the event of FN14: ERROR with the NC CANCEL reaction instead of aborting the program with an error message. The error number programmed in the FN14 command can be read under ID992 NR14. Value = 0: FN14 has the normal effect.
		3	-	Label jumped to in the event of an internal server error (SQL, PLC, CFG) or with erroneous file operations (FUNCTION FILECOPY, FUNCTION FILEMOVE, or FUNCTION FILEDELETE) instead of aborting the program with an error message. Value = 0: Error has the normal effect.
<b>Machine status</b>				
	20	1	-	Active tool number
		2	-	Prepared tool number
		3	-	Active tool axis 0 = X 6 = U 1 = Y 7 = V 2 = Z 8 = W
		4	-	Programmed spindle speed
		5	-	Active spindle condition -1 = spindle condition not defined 0 = M3 active 1 = M4 active 2 = M5 active after M3 3 = M5 active after M4
		7	-	Active gear range
		8	-	Active coolant status 0 = off, 1 = on
		9	-	Active feed rate
		10	-	Index of prepared tool
		11	-	Index of active tool
		14	-	Number of active spindle
		20	-	Programmed cutting speed in turning operation
		21	-	Spindle mode in turning mode: 0 = constant speed 1 = constant cutting speed
		22	-	Coolant status M7: 0 = inactive, 1 = active

Group name	Gruppen-nummerID	Systemdaten-nummer	Index	Description
		23	-	Coolant status M8: 0 = inactive, 1 = active
<b>Channel data</b>				
	25	1	-	Channel number
<b>Cycle parameters</b>				
	30	1	-	Set-up clearance
		2	-	Hole depth / milling depth
		3	-	Plunging depth
		4	-	Feed rate for plunging
		5	-	First side length of pocket
		6	-	Second side length of pocket
		7	-	First side length of slot
		8	-	Second side length of slot
		9	-	Radius of circular pocket
		10	-	Feed rate for milling
		11	-	Rotational direction of the milling path
		12	-	Dwell time
		13	-	Thread pitch for Cycles 17 and 18
		14	-	Finishing allowance
		15	-	Roughing angle
		21	-	Probing angle
		22	-	Probing path
		23	-	Probing feed rate
		49	-	HSC mode (Cycle 32 Tolerance)
		50	-	Tolerance for rotary axes (Cycle 32 Tolerance)
		52	Q parameter number	Type of transfer parameter for user cycles: -1: Cycle parameter not programmed in CYCL DEF 0: Cycle parameter numerically programmed in CYCL DEF (Q parameter) 1: Cycle parameter programmed as string in CYCL DEF (Q parameter)
		60	-	Clearance height (touch probe cycles 30 to 33)
		61	-	Inspection (touch probe cycles 30 to 33)
		62	-	Cutting edge measurement (touch probe cycles 30 to 33)
		63	-	Q parameter number for the result (touch probe cycles 30 to 33)
		64	-	Q parameter type for the result (touch probe cycles 30 to 33) 1 = Q, 2 = QL, 3 = QR

Group name	Gruppen-nummerID	Systemdaten-nummer	Index	Description
		70	-	Multiplier for feed rate (cycles 17 and 18)
<b>Modal status</b>				
	35	1	-	Dimensions: 0 = absolute (G90) 1 = incremental (G91)
<b>Data for SQL tables</b>				
	40	1	-	Result code for the last SQL command. If the last result code was 1 (=error), the error code is transferred as the return code.
<b>Data from the tool table</b>				
	50	1	Tool no.	Tool length L
		2	Tool no.	Tool radius R
		3	Tool no.	Tool radius R2
		4	Tool no.	Oversize for tool length DL
		5	Tool no.	Tool radius oversize DR
		6	Tool no.	Tool radius oversize DR2
		7	Tool no.	Tool locked TL 0 = not locked, 1 = locked
		8	Tool no.	Number of the replacement tool RT
		9	Tool no.	Maximum tool age TIME1
		10	Tool no.	Maximum tool age TIME2
		11	Tool no.	Current tool age CUR.TIME
		12	Tool no.	PLC status
		13	Tool no.	Maximum tooth length LCUTS
		14	Tool no.	Maximum plunge angle ANGLE
		15	Tool no.	TT: Number of tool teeth CUT
		16	Tool no.	TT: Wear tolerance for length, LTOL
		17	Tool no.	TT: Wear tolerance for radius, RTOL
		18	Tool no.	TT: Direction of rotation DIRECT 0 = positive, -1 = negative
		19	Tool no.	TT: Offset in plane R-OFFS R = 99999.9999
		20	Tool no.	TT: Offset in length L-OFFS
		21	Tool no.	TT: Breakage tolerance for length, LBREAK
		22	Tool no.	TT: Breakage tolerance for radius, RBREAK
		28	Tool no.	Maximum speed NMAX
		32	Tool no.	Point angle TANGLE
		34	Tool no.	LIFTOFF allowed (0 = No, 1 = Yes)
		35	Tool no.	Wear tolerance for radius R2TOL

Group name	Gruppen-nummerID	Systemdaten-nummer	Index	Description
		36	Tool no.	Tool type TYPE (miller = 0, grinder = 1, ... touch probe = 21)
		37	Tool no.	Corresponding line in the touch-probe table
		38	Tool no.	Timestamp of last use
		39	Tool no.	ACC
		40	Tool no.	Pitch for thread cycles
<b>Data from the pocket table</b>				
	51	1	Pocket number	Tool number
		2	Pocket number	0 = no special tool 1 = special tool
		3	Pocket number	0 = no fixed pocket 1 = fixed pocket
		4	Pocket number	0 = pocket not locked 1 = pocket locked
		5	Pocket number	PLC status
<b>Determine the tool pocket</b>				
	52	1	Tool no.	Pocket number
		2	Tool no.	Tool magazine number
<b>Tool data for T and S strobes</b>				
	57	1	T code	Tool number IDX0 = T0 strobe (store tool), IDX1 = T1 strobe (load tool), IDX2 = T2 strobe (prepare tool)
		2	T code	Tool index IDX0 = T0 strobe (store tool), IDX1 = T1 strobe (load tool), IDX2 = T2 strobe (prepare tool)
		5	-	Spindle speed IDX0 = T0 strobe (store tool), IDX1 = T1 strobe (load tool), IDX2 = T2 strobe (prepare tool)
<b>Values programmed in TOOL CALL</b>				
	60	1	-	Tool number T
		2	-	Active tool axis 0 = X 1 = Y 2 = Z 6 = U 7 = V 8 = W
		3	-	Spindle speed S
		4	-	Oversize for tool length DL
		5	-	Tool radius oversize DR
		6	-	Automatic TOOL CALL 0 = Yes, 1 = No

Group name	Gruppen-nummerID	Systemdaten-nummer	Index	Description
		7	-	Tool radius oversize DR2
		8	-	Tool index
		9	-	Active feed rate
		10	-	Cutting speed [mm/min]
<b>Values programmed in TOOL DEF</b>				
	61	0	Tool no.	Read the number of the tool change sequence: 0 = Tool already in spindle, 1 = Change between external tools, 2 = Change from internal to external tool, 3 = Change from special tool to external tool, 4 = Load external tool, 5 = Change from external to internal tool, 6 = Change from internal to internal tool, 7 = Change from special tool to internal tool, 8 = Load internal tool, 9 = Change from external tool to special tool, 10 = Change from special tool to internal tool, 11 = Change from special tool to special tool, 12 = Load special tool, 13 = Unload external tool, 14 = Unload internal tool, 15 = Unload special tool
		1	-	Tool number T
		2	-	Length
		3	-	Radius
		4	-	Index
		5	-	Tool data programmed in TOOL DEF 1 = Yes, 0 = No

Group name	Gruppen-nummerID	Systemdaten-nummer	Index	Description
<b>Values for LAC and VSC</b>				
	71	0	0	Index of the NC axis for which the LAC weighing run will be performed or was last performed (X to W = 1 to 9)
			2	Total inertia determined by the LAC weighing run in [kgm <sup>2</sup> ] (with A/B/C rotary axes) or total mass in [kg] (with X/Y/Z linear axes)
		1	0	Cycle 957 Retraction from thread
<b>Freely available memory area for OEM cycles</b>				
	72	0-39	0 to 30	Freely available memory area for OEM cycles. The values are only reset by the control during a control reboot (= 0). With "Cancel," the values are not reset to the value that they had at the time of execution. Up to and including 597110-11: only NR 0-9 and IDX 0-9 Starting with 597110-12: NR 0-39 and IDX 0-30
<b>Freely available memory area for user cycles</b>				
	73	0-39	0 to 30	Freely available memory area for user cycles The values are only reset by the control during a control reboot (= 0). With "Cancel," the values are not reset to the value that they had at the time of execution. Up to and including 597110-11: only NR 0-9 and IDX 0-9 Starting with 597110-12: NR 0-39 and IDX 0-30
<b>Minimum spindle speed</b>				
	90	1	Spindle ID	Minimum spindle speed of the lowest gear range. If no gear ranges are configured, the spindle speed is taken from the parameter set with index 0. Index 99 = active spindle
<b>Tool compensation</b>				
	200	1	1 = without oversize 2 = with oversize 3 = with oversize and oversize from TOOL CALL	Active radius
		2	1 = without oversize 2 = with oversize 3 = with	Active length

Group name	Gruppen-nummerID	Systemdaten-nummer	Index	Description
			oversize and oversize from TOOL CALL	
		3	1 = without oversize 2 = with oversize 3 = with oversize and oversize from TOOL CALL	Rounding radius R2
		6	Tool no.	Tool length Index 0= active tool
<b>Coordinate transformations</b>				
	210	1	-	Basic rotation (manual)
		2	-	Programmed rotation
		3	-	Active mirror axis. Bits 0 to 2 and 6 to 8: Axes X, Y, Z and U, V, W
		4	Axis	Active scaling factor Index: 1 - 9 (X, Y, Z, A, B, C, U, V, W)
		5	Rotary axis	3D-ROT Index: 1 - 3 (A, B, C)
		6	-	Tilt working plane in Program Run operating modes 0 = Not active -1 = Active
		7	-	Tilt working plane in Manual operating modes 0 = Not active -1 = Active
		8	QL parameter no.	Angle of misalignment between spindle and tilted coordinate system. Projects the angle specified in the QL parameter from the input coordinate system to the tool coordinate system. If IDX is omitted, the angle 0 is used for projection.

Group name	Gruppen-nummerID	Systemdaten-nummer	Index	Description
<b>Active coordinate system</b>				
	211	–	-	1 = input system (default) 2 = REF system 3 = tool change system
<b>Special transformations in turning mode</b>				
	215	1	-	Angle for the precession of the input system in the XY plane in turning mode To reset the transformation the value 0 must be entered for the angle. This transformation is used in connection with Cycle 800 (parameter Q497).
		3	1-3	Reading out of the spatial angle written with NR2 Index: 1 - 3 (redA, redB, redC)
<b>Current datum shift</b>				
	220	2	Axis	Current datum shift in [mm] Index: 1 - 9 (X, Y, Z, A, B, C, U, V, W)
		3	Axis	Read the difference between reference point and preset. Index: 1 - 9 (X, Y, Z, A, B, C, U, V, W)
		4	Axis	Read values for OEM offset. Index: 1 - 9 ( X_OFFS, Y_OFFS, Z_OFFS,... )
<b>Traverse range</b>				
	230	2	Axis	Negative software limit switches Index: 1 - 9 (X, Y, Z, A, B, C, U, V, W)
		3	Axis	Positive software limit switches Index: 1 - 9 (X, Y, Z, A, B, C, U, V, W)
		5	-	Software limit switch on or off: 0 = on, 1 = off For modulo axes, either both the upper and lower limits or no limit at all must be set.
		12	Axis	Persistently overwrite the value for the negative software limit switch in CfgPosition-Limits. Index: 1 - 9 (X, Y, Z, A, B, C, U, V, W)
		13	Axis	Persistently overwrite the value for the positive software limit switch in CfgPosition-Limits. Index: 1 - 9 (X, Y, Z, A, B, C, U, V, W)
<b>Read the nominal position in the REF system</b>				
	240	1	Axis	Current nominal position in the REF system
<b>Read the nominal position in the REF system, including offsets (handwheel, etc.)</b>				
	241	1	Axis	Current nominal position in the REF system
<b>Read the current position in the active coordinate system</b>				
	270	1	Axis	Current nominal position in the input system
<b>Read the current position in the active coordinate system, including offsets (handwheel, etc.)</b>				



Group name	Gruppen-nummerID	Systemdaten-nummer	Index	Description
	271	1	Axis	Current nominal position in the input system
<b>Read information to M128</b>				
	280	1	-	M128 active: -1 = Yes, 0 = No
<b>Machine kinematics</b>				
	290	5	-	0: Temperature compensation not active 1: Temperature compensation active
		10	-	Index of the machine kinematics from Channels/ChannelSettings/CfgKin-List/kinCompositeModels programmed in FUNCTION MODE MILL or FUNCTION MODE TURN -1 = Not programmed.
<b>Read data of the machine kinematics</b>				
	295	1	QS parameter no.	Read the axis names of the active 3-axis kinematics. The axis names are written according to QS(IDX), QS(IDX+1), and QS(IDX+2). 0 = Operation successful
		2	0	Is FACING HEAD POS function active? 1 = Yes, 0 = No
		4	Rotary axis	Read whether the defined rotary axis participates in the kinematic calculation. 1 = Yes, 0 = No (A rotary axis can be excluded from the kinematics calculating using M138.) Index: 4, 5, 6 ( A, B, C )
		10	Axis	Determine programmable axes. Determine the axis ID associated with the specified axis index (index from CfgAxis/axisList). Index: 1 - 9 ( X, Y, Z, A, B, C, U, V, W )
		11	Axis ID	Determine programmable axes. Determine the index of the axis (X = 1, Y = 2, ...) for the specified axis ID Index: Axis ID (index from CfgAxis/axisList)
<b>Modify the geometrical behavior</b>				
	310	20	Axis	Diameter programming: -1 = on, 0 = off
<b>Current system time</b>				
	320	1	0	System time in seconds that has elapsed since 01.01.1970, 00:00:00 (real time).
			1	System time in seconds that has elapsed since 01.01.1970, 00:00:00 (look-ahead calculation).
		3	-	Read the processing time of the current NC program.

Group name	Gruppen-nummerID	Systemdaten-nummer	Index	Description
<b>Formatting of system time</b>				
	321	0	0	Formatting of: System time in seconds that have elapsed since 00:00:00 UTC on January 1, 1970 (real time) Format: DD.MM.YYYY hh:mm:ss
			1	Formatting of: System time in seconds that have elapsed since 00:00:00 UTC on January 1, 1970 (look-ahead calculation) Format: DD.MM.YYYY hh:mm:ss
		1	0	Formatting of: System time in seconds that have elapsed since 00:00:00 UTC on January 1, 1970 (real time) Format: D.MM.YYYY h:mm:ss
			1	Formatting of: System time in seconds that have elapsed since 00:00:00 UTC on January 1, 1970 (look-ahead calculation) Format: D.MM.YYYY h:mm:ss
		2	0	Formatting of: System time in seconds that have elapsed since 00:00:00 UTC on January 1, 1970 (real time) Format: D.MM.YYYY h:mm
			1	Formatting of: System time in seconds that have elapsed since 00:00:00 UTC on January 1, 1970 (look-ahead calculation) Format: D.MM.YYYY h:mm
		3	0	Formatting of: System time in seconds that have elapsed since 00:00:00 UTC on January 1, 1970 (real time) Format: D.MM.YY h:mm
			1	Formatting of: System time in seconds that have elapsed since 00:00:00 UTC on January 1, 1970 (look-ahead calculation) Format: D.MM.YY h:mm
		4	0	Formatting of: System time in seconds that have elapsed since 00:00:00 UTC on January 1, 1970 (real time) Format: YYYY-MM-DD hh:mm:ss
			1	Formatting of: System time in seconds that have elapsed since 00:00:00 UTC on January 1, 1970 (look-ahead calculation) Format: YYYY-MM-DD hh:mm:ss
		5	0	Formatting of: System time in seconds that have elapsed since 00:00:00 UTC on January 1, 1970 (real time) Format: YYYY-MM-DD hh:mm
			1	Formatting of: System time in seconds that have elapsed since 00:00:00 UTC on January 1, 1970 (look-ahead calculation) Format: YYYY-MM-DD hh:mm

Group name	Gruppen-nummerID	Systemdaten-nummer	Index	Description
		6	0	Formatting of: System time in seconds that have elapsed since 00:00:00 UTC on January 1, 1970 (real time) Format: YYYY-MM-DD h:mm
			1	Formatting of: System time in seconds that have elapsed since 00:00:00 UTC on January 1, 1970 (look-ahead calculation) Format: YYYY-MM-DD h:mm
		7	0	Formatting of: System time in seconds that have elapsed since 00:00:00 UTC on January 1, 1970 (real time) Format: YY-MM-DD h:mm
			1	Formatting of: System time in seconds that have elapsed since 00:00:00 UTC on January 1, 1970 (look-ahead calculation) Format: YY-MM-DD h:mm
		8	0	Formatting of: System time in seconds that have elapsed since 00:00:00 UTC on January 1, 1970 (real time) Format: DD.MM.YYYY
			1	Formatting of: System time in seconds that have elapsed since 00:00:00 UTC on January 1, 1970 (look-ahead calculation) Format: DD.MM.YYYY
		9	0	Formatting of: System time in seconds that have elapsed since 00:00:00 UTC on January 1, 1970 (real time) Format: D.MM.YYYY
			1	Formatting of: System time in seconds that have elapsed since 00:00:00 UTC on January 1, 1970 (look-ahead calculation) Format: D.MM.YYYY
		10	0	Formatting of: System time in seconds that have elapsed since 00:00:00 UTC on January 1, 1970 (real time) Format: D.MM.YY
			1	Formatting of: System time in seconds that have elapsed since 00:00:00 UTC on January 1, 1970 (look-ahead calculation) Format: D.MM.YY
		11	0	Formatting of: System time in seconds that have elapsed since 00:00:00 UTC on January 1, 1970 (real time) Format: YYYY-MM-DD
			1	Formatting of: System time in seconds that have elapsed since 00:00:00 UTC on January 1, 1970 (look-ahead calculation) Format: YYYY-MM-DD

Group name	Gruppen-nummerID	Systemdaten-nummer	Index	Description
		12	0	Formatting of: System time in seconds that have elapsed since 00:00:00 UTC on January 1, 1970 (real time) Format: YY-MM-DD
			1	Formatting of: System time in seconds that have elapsed since 00:00:00 UTC on January 1, 1970 (look-ahead calculation) Format: YY-MM-DD
		13	0	Formatting of: System time in seconds that have elapsed since 00:00:00 UTC on January 1, 1970 (real time) Format: hh:mm:ss
			1	Formatting of: System time in seconds that have elapsed since 00:00:00 UTC on January 1, 1970 (look-ahead calculation) Format: hh:mm:ss
		14	0	Formatting of: System time in seconds that have elapsed since 00:00:00 UTC on January 1, 1970 (real time) Format: h:mm:ss
			1	Formatting of: System time in seconds that have elapsed since 00:00:00 UTC on January 1, 1970 (look-ahead calculation) Format: h:mm:ss
		15	0	Formatting of: System time in seconds that have elapsed since 00:00:00 UTC on January 1, 1970 (real time) Format: h:mm
			1	Formatting of: System time in seconds that have elapsed since 00:00:00 UTC on January 1, 1970 (look-ahead calculation) Format: h:mm

Group name	Gruppen-nummerID	Systemdaten-nummer	Index	Description
<b>Global Program Settings (GPS): Global activation status</b>				
	330	0	-	0 = No GPS setting is active 1 = Any GPS setting is active
<b>Global Program Settings (GPS): Individual activation status</b>				
	331	0	-	0 = No GPS setting is active 1 = Any GPS setting is active
		1	-	GPS: Basic rotation 0 = Off, 1 = On
		3	Axis	GPS: Mirroring 0 = Off, 1 = On Index: 1 - 6 (X, Y, Z, A, B, C)
		4	-	GPS: Shift in the modified workpiece system 0 = Off, 1 = On
		5	-	GPS: Rotation in input system 0 = Off, 1 = On
		6	-	GPS: Feed rate factor 0 = Off, 1 = On
		8	-	GPS: Handwheel superimpositioning 0 = Off, 1 = On
		10	-	GPS: Virtual tool axis VT 0 = Off, 1 = On
		15	-	GPS: Selection of the handwheel coordinate system 0 = Machine coordinate system M-CS 1 = Workpiece coordinate system W-CS 2 = Modified workpiece coordinate system mW-CS 3 = Working plane coordinate system WPL-CS
		16	-	GPS: Shift in the workpiece system 0 = Off, 1 = On
		17	-	GPS: Axis offset 0 = Off, 1 = On

Group name	Gruppen-nummerID	Systemdaten-nummer	Index	Description
<b>Global Program Settings (GPS)</b>				
	332	1	-	GPS: Angle of a basic rotation
		3	Axis	GPS: Mirroring 0 = Not mirrored, 1 = Mirrored Index: 1 - 6 ( X, Y, Z, A, B, C )
		4	Axis	GPS: Shift in the modified workpiece coordinate system mW-CS Index: 1 - 6 ( X, Y, Z, A, B, C )
		5	-	GPS: Angle of rotation in input coordinate system I-CS
		6	-	GPS: Feed rate factor
		8	Axis	GPS: Handwheel superimpositioning Maximum value Index: 1 - 10 ( X, Y, Z, A, B, C, U, V, W, VT )
		9	Axis	GPS: Value for handwheel superimpositioning Index: 1 - 10 ( X, Y, Z, A, B, C, U, V, W, VT )
		16	Axis	GPS: Shift in the workpiece coordinate system W-CS Index: 1 - 3 ( X, Y, Z )
		17	Axis	GPS: Axis offset Index: 4 - 6 ( A, B, C )
<b>TS touch trigger probe</b>				
	350	50	1	Touch probe type: 0: TS120, 1: TS220, 2: TS440, 3: TS630, 4: TS632, 5: TS640, 6: TS444, 7: TS740
			2	Line in the touch-probe table
		51	-	Effective length
		52	1	Effective radius of the stylus tip
			2	Rounding radius
		53	1	Center offset (reference axis)
			2	Center offset (minor axis)
		54	-	Spindle-orientation angle in degrees (center offset)
		55	1	Rapid traverse
			2	Measuring feed rate
			3	Feed rate for pre-positioning: FMAX_PROBE or FMAX_MACHINE
		56	1	Maximum measuring range
			2	Set-up clearance
		57	1	Spindle orientation possible 0=No, 1=Yes
			2	Angle of spindle orientation in degrees

Group name	Gruppen-nummerID	Systemdaten-nummer	Index	Description	
<b>TT tool touch probe for tool measurement</b>					
350	70	1		TT: Touch probe type	
		2		TT: Line in the tool touch probe table	
		71	1/2/3	TT: Touch probe center (REF system)	
		72	-	TT: Touch probe radius	
		75	1		TT: Rapid traverse
			2		TT: Measuring feed rate with stationary spindle
			3		TT: Measuring feed rate with rotating spindle
		76	1		TT: Maximum probing path
			2		TT: Safety clearance for linear measurement
			3		TT: Safety clearance for radius measurement
			4		TT: Distance from the lower edge of the cutter to the upper edge of the stylus
		77	-		TT: Spindle speed
		78	-		TT: Probing direction
		79	-		TT: Activate radio transmission
		80	-		TT: Stop probing movement upon stylus deflection
		<b>Preset from touch probe cycle (probing results)</b>			
360	1	Coordinate		Last preset of a manual touch probe cycle, or last touch point from Cycle 0 (input coordinate system). Compensations: length, radius, and center offset	
		Axis		Last preset of a manual touch probe cycle, or last touch point from Cycle 0 (machine coordinate system, only axes from the active 3-D kinematics are allowed as index). Compensation: only center offset	
		Coordinate		Result of measurement in the input system of touch probe Cycles 0 and 1. The measurement result is read out in the form of coordinates. Compensation: only center offset	
		Coordinate		Last preset of a manual touch probe cycle, or last touch point from Cycle 0 (workpiece coordinate system) The measurement result is read in the form of coordinates. Compensation: only center offset	
		Axis		Axis values, not compensated	
		Coordinate / axis		Readout of the measurement results in the form of coordinates / axis values in the input system from probing operations. Compensation: only length	
		-		Oriented spindle stop	
		10	-		

Group name	Gruppen-nummerID	Systemdaten-nummer	Index	Description
		11	-	Error status of probing: 0: Probing was successful -1: Touch point not reached -2: Touch probe already deflected at the start of the probing process
<b>Read values from or write values to the active datum table</b>				
	500	Row number	Column	Read values
<b>Read values from or write values to the preset table (basic transformation)</b>				
	507	Row number	1-6	Read values
<b>Read axis offsets from or write axis offsets to the preset table</b>				
	508	Row number	1-9	Read values
<b>Data for pallet machining</b>				
	510	1	-	Active line
		2	-	Pallet number from the PAL/PGM field
		3	-	Active row of the pallet table.
		4	-	Last line of the NC program for the current pallet.
		5	Axis	Tool-oriented editing: Clearance height is programmed: 0 = No, 1 = Yes Index: 1 - 9 ( X, Y, Z, A, B, C, U, V, W )
		6	Axis	Tool-oriented editing: Clearance height The value is invalid if ID510 NR5 returns the value 0 with the corresponding IDX. Index: 1 - 9 ( X, Y, Z, A, B, C, U, V, W )
		10	-	Row number up to which the pallet table is to be searched during block scan.
		20	-	Type of pallet editing? 0 = Workpiece-oriented 1 = Tool oriented
	21	-	Automatic continuation after NC error: 0 = Locked 1 = Active 10 = Abort continuation 11 = Continuation with the rows in the pallet table that would have been executed next if not for the NC error 12 = Continuation with the row in the pallet table in which the NC error arose 13 = Continuation with the next pallet	



Group name	Gruppen-nummerID	Systemdaten-nummer	Index	Description
<b>Read data from the point table</b>				
	520	Row number	1-3 X/Y/Z	Read value from active point table.
			10	Read value from active point table.
			11	Read value from active point table.
<b>Read or write the active preset</b>				
	530	1	-	Number of the active preset in the active preset table.
<b>Active pallet preset</b>				
	540	1	-	Number of the active pallet preset. Returns the number of the active preset. If no pallet preset is active, the function returns the value -1.
		2	-	Number of the active pallet preset. As with NR1.
<b>Values for the basic transformation of the pallet preset</b>				
	547	row number	Axis	Read values of the basic transformation from the pallet preset table. Index: 1 - 6 ( X, Y, Z, SPA, SPB, SPC )
<b>Axis offsets from the pallet preset table</b>				
	548	Row number	Offset	Read values of the axis offsets from the pallet preset table. Index: 1 - 9 ( X_OFFS, Y_OFFS, Z_OFFS,... )
<b>OEM offset</b>				
	558	Row number	Offset	Read values for OEM offset. Index: 1 - 9 ( X_OFFS, Y_OFFS, Z_OFFS,... )
<b>Read and write the machine status</b>				
	590	2	1-30	Freely available; not deleted during program selection.
		3	1-30	Freely available; not deleted during a power failure (persistent storage).
<b>Read/write look-ahead parameter of a single axis (at machine level)</b>				
	610	1	-	Minimum feed rate ( <b>MP_minPathFeed</b> ) in mm/min
		2	-	Minimum feed rate at corners ( <b>MP_min-CornerFeed</b> ) in mm/min
		3	-	Feed-rate limit for high speeds ( <b>MP_maxG1Feed</b> ) in mm/min
		4	-	Max. jerk at low speeds ( <b>MP_maxPathJerk</b> ) in m/s <sup>3</sup>
		5	-	Max. jerk at high speeds ( <b>MP_maxPath-JerkHi</b> ) in m/s <sup>3</sup>
		6	-	Tolerance at low speeds ( <b>MP_pathTolerance</b> ) in mm

Group name	Gruppen-nummerID	Systemdaten-nummer	Index	Description
		7	-	Tolerance at high speeds ( <b>MP_pathToleranceHi</b> ) in mm
		8	-	Max. derivative of jerk ( <b>MP_maxPathYank</b> ) in m/s <sup>4</sup>
		9	-	Tolerance factor for curve machining ( <b>MP_curveTolFactor</b> )
		10	-	Factor for max. permissible jerk at curvature changes ( <b>MP_curveJerkFactor</b> )
		11	-	Maximum jerk with probing movements ( <b>MP_pathMeasJerk</b> )
		12	-	Angle tolerance for machining feed rate ( <b>MP_angleTolerance</b> )
		13	-	Angle tolerance for rapid traverse ( <b>MP_angleToleranceHi</b> )
		14	-	Max. corner angle for polygons ( <b>MP_maxPolyAngle</b> )
		18	-	Radial acceleration with machining feed rate ( <b>MP_maxTransAcc</b> )
		19	-	Radial acceleration with rapid traverse ( <b>MP_maxTransAccHi</b> )
		20	Index of physical axis	Max. feed rate ( <b>MP_maxFeed</b> ) in mm/min
		21	Index of physical axis	Max. acceleration ( <b>MP_maxAcceleration</b> ) in m/s <sup>2</sup>
		22	Index of physical axis	Maximum transition jerk of the axis in rapid traverse ( <b>MP_axTransJerkHi</b> ) in m/s <sup>2</sup>
		23	Index of physical axis	Maximum transition jerk of the axis during machining free rate ( <b>MP_axTransJerk</b> ) in m/s <sup>3</sup>
		24	Index of physical axis	Acceleration feedforward control ( <b>MP_compAcc</b> )
		25	Index of physical axis	Axis-specific jerk at low speeds ( <b>MP_axPathJerk</b> ) in m/s <sup>3</sup>
		26	Index of physical axis	Axis-specific jerk at high speeds ( <b>MP_axPathJerkHi</b> ) in m/s <sup>3</sup>
		27	Index of physical axis	More precise tolerance examination in corners ( <b>MP_reduceCornerFeed</b> ) 0 = deactivated, 1 = activated
		28	Index of physical axis	DCM: Maximum tolerance for linear axes in mm ( <b>MP_maxLinearTolerance</b> )
		29	Index of physical axis	DCM: Maximum angle tolerance in [°] ( <b>MP_maxAngleTolerance</b> )
		30	Index of physical axis	Tolerance monitoring for successive threads ( <b>MP_threadTolerance</b> )

Group name	Gruppen-nummerID	Systemdaten-nummer	Index	Description
		31	Index of physical axis	Form ( <b>MP_shape</b> ) of the <b>axisCutterLoc</b> filter 0: Off 1: Average 2: Triangle 3: HSC 4: Advanced HSC
		32	Index of physical axis	Frequency ( <b>MP_frequency</b> ) of the <b>axisCutterLoc</b> filter in Hz
		33	Index of physical axis	Form ( <b>MP_shape</b> ) of the <b>axisPosition</b> filter 0: Off 1: Average 2: Triangle 3: HSC 4: Advanced HSC
		34	Index of physical axis	Frequency ( <b>MP_frequency</b> ) of the <b>axisPosition</b> filter in Hz
		35	Index of physical axis	Order of the filter for <b>Manual</b> operating mode ( <b>MP_manualFilterOrder</b> )
		36	Index of physical axis	HSC mode ( <b>MP_hscMode</b> ) of the <b>axisCutterLoc</b> filter
		37	Index of physical axis	HSC mode ( <b>MP_hscMode</b> ) of the <b>axisPosition</b> filter
		38	Index of physical axis	Axis-specific jerk for probing movements ( <b>MP_axMeasJerk</b> )
		39	Index of physical axis	Weighting of the filter error for calculating filter deviation ( <b>MP_axFilterErrWeight</b> )
		40	Index of physical axis	Maximum filter length of position filter ( <b>MP_maxHscOrder</b> )
		41	Index of physical axis	Maximum filter length of CLP filter ( <b>MP_maxHscOrder</b> )
		42	-	Maximum feed rate of the axis at machining feed rate ( <b>MP_maxWorkFeed</b> )
		43	-	Maximum path acceleration at machining feed rate ( <b>MP_maxPathAcc</b> )
		44	-	Maximum path acceleration at rapid traverse ( <b>MP_maxPathAcHi</b> )
		51	Index of physical axis	Compensation of following error in the jerk phase ( <b>MP_lpcJerkFact</b> )
		52	Index of physical axis	kv factor of the position controller in 1/s ( <b>MP_kvFactor</b> )

Group name	Gruppen-nummerID	Systemdaten-nummer	Index	Description
<b>Measure the maximum utilization of an axis</b>				
	621	0	Index of physical axis	Conclude measurement of the dynamic load and save the result in the specified Q parameter.
<b>Read SIK contents</b>				
	630	0	Option no.	You can explicitly determine whether the SIK option given under <b>IDX</b> has been set or not. 1 = option is enabled 0 = option is not enabled
		1	-	You can determine whether a Feature Content Level (for upgrade functions) is set, and which one. -1 = No FCL is set <No.> = FCL that is set
		2	-	Read serial number of the SIK -1 = No valid SIK in the system
		10	-	Define the type of control: 0 = iTNC 530 1 = NCK-based control (TNC 640, TNC 620, TNC 320, TNC 128, PNC 610, ...)
<b>Workpiece counter</b>				
	920	1	-	Planned workpieces. In <b>Test Run</b> operating mode the counter generally generates the value 0.
		2	-	Already machined workpieces. In <b>Test Run</b> operating mode the counter generally generates the value 0.
		12	-	Workpieces still to be machined. In <b>Test Run</b> operating mode the counter generally generates the value 0.
<b>Read and write data of current tool</b>				
	950	1	-	Tool length L
		2	-	Tool radius R
		3	-	Tool radius R2
		4	-	Oversize for tool length DL
		5	-	Tool radius oversize DR
		6	-	Tool radius oversize DR2
		7	-	Tool locked TL 0 = not locked, 1 = locked
		8	-	Number of the replacement tool RT
		9	-	Maximum tool age TIME1
		10	-	Maximum tool age TIME2 at TOOL CALL
		11	-	Current tool age CUR.TIME
		12	-	PLC status

Group name	Gruppen-nummerID	Systemdaten-nummer	Index	Description
		13	-	Tooth length in the tool axis LCUTS
		14	-	Maximum plunge angle ANGLE
		15	-	TT: Number of tool teeth CUT
		16	-	TT: Wear tolerance for length LTOL
		17	-	TT: Wear tolerance for radius RTOL
		18	-	TT: Direction of rotation DIRECT 0 = positive, -1 = negative
		19	-	TT: Offset in plane R-OFFS R = 99999.9999
		20	-	TT: Offset in length L-OFFS
		21	-	TT: Break tolerance for length LBREAK
		22	-	TT: Break tolerance for radius RBREAK
		28	-	Maximum spindle speed [rpm] NMAX
		32	-	Point angle TANGLE
		34	-	LIFTOFF allowed (0 = No, 1 = Yes)
		35	-	Wear tolerance for radius R2TOL
		36	-	Tool type TYPE (miller = 0, grinder = 1, ... touch probe = 21)
		37	-	Corresponding line in the touch-probe table
		38	-	Timestamp of last use
		39	-	ACC
		40	-	Pitch for thread cycles
		44	-	Exceeding the tool life

#### Freely available memory area for tool management

	956	0-9	-	Freely available data area for tool management. The data is not reset when the program is aborted.
--	-----	-----	---	----------------------------------------------------------------------------------------------------

#### Transformation data for general tools

	960	1	-	Position within the tool system explicitly defined:
		2	-	Position defined by directions:
		3	-	Shift in X
		4	-	Shift in Y
		5	-	Shift in Z
		6	-	X component of the Z direction
		7	-	Y component of the Z direction
		8	-	Z component of the Z direction
		9	-	X component of the X direction
		10	-	Y component of the X direction

<b>Group name</b>	<b>GruppennummerID</b>	<b>Systemdatennummer</b>	<b>Index</b>	<b>Description</b>
		11	-	Z component of the X direction
		12	-	Type of angle definition:
		13	-	Angle 1
		14	-	Angle 2
		15	-	Angle 3

Group name	Gruppen-nummerID	Systemdaten-nummer	Index	Description
<b>Tool usage and tooling</b>				
	975	1	-	Tool usage test for the current program: Result -2: Test not possible, function disabled in the configuration Result -1: Test not possible, tool usage file missing Result 0: Test OK, all tools available Result 1: Test not OK
		2	Line	Check availability of the tools required in the pallet from line IDX in the current pallet table. -3 = No pallet is defined in row IDX, or function was called outside of pallet editing -2 / -1 / 0 / 1 see NR1
<b>Lift off the tool at NC stop</b>				
	980	3	-	(This function is obsolete—HEIDENHAIN recommends not to use it any longer. ID980 NR3 = 1 is equivalent to ID980 NR1 = -1, ID980 NR3 = 0 has the same effect as ID980 NR1 = 0. Other values are not permissible.) Enable lift-off to the value defined in CfgLiftOff: 0 = Lock lift-off function 1 = Enable lift-off function
<b>Touch probe cycles and coordinate transformations</b>				
	990	1	-	Approach behavior: 0 = Standard behavior 1 = Approach probing position without compensation Effective radius, set-up clearance is zero
		2	16	Automatic / Manual machine operating modes
		4	-	0 = Stylus not deflected 1 = Stylus deflected
		6	-	TT tool touch probe active? 1 = Yes 0 = No
		8	-	Momentary spindle angle in [°]
		10	QS parameter no.	Determine the tool number from the tool name. The return value depends on the rules configured for the search of the replacement tool. If there are multiple tools with the same name, the first tool from the tool table will be selected. If the tool selected by these rules is locked, a replacement tool will be returned. -1: No tool with the specified name found in the tool table or all qualifying tools are locked.

Group name	Gruppen-nummerID	Systemdaten-nummer	Index	Description
		16	0	0 = Transfer control over the channel spindle to the PLC, 1 = Assume control over the channel spindle
			1	0 = Pass tool spindle control to the PLC, 1 = Take control of the tool spindle
		19	-	Suppress touch prove movement in cycles: 0 = Movement will be suppressed (CfgMachineSimul/simMode parameter not equal to FullOperation or <b>Test Run</b> operating mode is active) 1 = Movement will be performed (CfgMachineSimul/simMode parameter = FullOperation, can be programmed for testing purposes)
<b>Status of execution</b>				
	992	10	-	Block scan active 1 = yes, 0 = no
		11	-	Block scan—information on block scan: 0 = Program started without block scan 1 = Inprog system cycle is run before block scan 2 = Block scan is running 3 = Functions are being implemented -1 = Inprog cycle was canceled before block scan -2 = Cancellation during block scan -3 = Cancellation of the block scan after the search phase, before or during the update of functions -99 = Implicit cancellation
		12	-	Type of canceling for interrogation within the OEM_CANCEL macro: 0 = No cancellation 1 = Cancellation due to error or emergency stop 2 = Explicit cancellation with internal stop after stop in the middle of the block 3 = Explicit cancellation with internal stop after stop at the end of a block
		14	-	Number of the last FN14 error
		16	-	Real execution active? 1 = execution, 0 = simulation
		17	-	2-D graphics during programming active? 1 = yes 0 = no
		18	-	Generate graphics during programming (soft key <b>AUTO DRAW</b> ) active? 1 = yes 0 = no



Group name	Gruppen-nummerID	Systemdaten-nummer	Index	Description
		20	-	Information on combined milling/turning mode of operation: 0 = Milling (after <b>FUNCTION MODE MILL</b> ) 1 = Turning (after <b>FUNCTION MODE TURN</b> ) 10 = Execute the operations for the turning-to-milling transition 11 = Execute the operations for the milling-to-turning transition
		30	-	Interpolation of multiple axes permitted? 0 = No (e.g. for straight cut control) 1 = yes
		31	-	R+/R- possible/permitted in MDI mode? 0 = No 1 = Yes
		32	0	Cycle call possible/permitted? 0 = No 1 = Yes
			Cycle number	Single cycle enabled: 0 = No 1 = Yes
		40	-	Copy tables in <b>Test Run</b> operating mode? Value 1 will be set when a program is selected and when the <b>RESET+START</b> soft key is pressed. The <b>iniprog.h</b> system cycle will then copy the tables and reset the system datum. 0 = no 1 = yes
		101	-	M101 active (visible condition)? 0 = no 1 = yes
		136	-	M136 active? 0 = no 1 = yes

Group name	Gruppen-nummerID	Systemdaten-nummer	Index	Description
<b>Activate machine parameter subfile</b>				
	1020	13	QS parameter no.	Has a machine parameter subfile with path from QS number (IDX) been loaded? 1 = Yes 0 = No
<b>Configuration settings for cycles</b>				
	1030	1	-	Display <b>spindle does not rotate</b> error message? <b>(CfgGeoCycle/displaySpindleErr)</b> 0 = no, 1 = yes
			-	Check <b>the algebraic sign for depth error message!</b> display? <b>(CfgGeoCycle/displayDepthErr)</b> 0 = no, 1 = yes
<b>Write or read PLC data synchronously in real time</b>				
	2000	10	Marker no.	PLC markers General note for NR10 to NR80: The functions are executed synchronously in real time, i.e. the function is not executed until the corresponding point is reached in the program. HEIDENHAIN recommends using the <b>WRITE TO PLC</b> or <b>READ FROM PLC</b> commands instead of ID2000 and synchronizing the execution in real time by using <b>FN20: WAIT FOR SYNC</b> .
		20	Input no.	PLC input
		30	Output no.	PLC output
		40	Counter no.	PLC counter
		50	Timer no.	PLC timer
		60	Byte no.	PLC byte
		70	Word no.	PLC word
		80	Double-word no.	PLC double word

Group name	Gruppen-nummerID	Systemdaten-nummer	Index	Description
<b>Do not write or read PLC data synchronously in real time</b>				
	2001	10-80	see ID 2000	Same as ID2000 NR10 to NR80, but not synchronous in real time. Function is executed in the look-ahead calculation. HEIDENHAIN recommends using the <b>WRITE TO PLC</b> and <b>READ FROM PLC</b> commands instead of ID2001.
<b>Bit test</b>				
	2300	Number	Bit number	This function checks whether a bit has been set in a number. The number to be checked is transferred as NR, the bit to be searched for as IDX, with IDX0 designating the least significant bit. To call this function for great numbers, make sure to transfer NR as a Q parameter. 0 = Bit not set 1 = Bit set
<b>Read program information (system string)</b>				
	10010	1	-	Path of the pallet subprogram, without subprogram calls using <b>CALL PGM</b>
		3	-	Path of the cycle selected with <b>SEL CYCLE</b> or <b>CYCLE DEF 12 PGM CALL</b> , or path of the currently active cycle
		10	-	Path of the NC program selected with <b>SEL PGM "..."</b> .
<b>Read channel data (system string)</b>				
	10025	1	-	Name of machining channel (key)
<b>Read data for SQL tables (system string)</b>				
	10040	1	-	Symbolic name of the preset table.
		2	-	Symbolic name of the datum table.
		3	-	Symbolic name of the pallet preset table.
		10	-	Symbolic name of the tool table.
		11	-	Symbolic name of the pocket table.
<b>Read machine kinematics</b>				
	10290	10	-	Symbolic name of the machine kinematics from Channels/ChannelSettings/CfgKinList/kinCompositeModels programmed in <b>FUNCTION MODE MILL</b> or <b>FUNCTION MODE TURN</b> .
<b>Read data of touch probes (TS, TT) (system string)</b>				
	10350	50	-	TS probe type from TYPE column of the touch probe table ( <b>tchprobe.tp</b> )
		70	-	Type of TT tool touch probe from CfgTT/type.
		73	-	Key name of the active tool touch probe TT from <b>CfgProbes/activeTT</b> .

Group name	Gruppen-nummerID	Systemdaten-nummer	Index	Description
<b>Read and write data of touch probes (TS, TT) (system string)</b>				
	10350	74	-	Serial number of the active tool touch probe TT from <b>CfgProbes/activeTT</b> .
<b>Read the data for pallet processing (system string)</b>				
	10510	1	-	Pallet name.
		2	-	Path of the selected pallet table.
<b>Read version ID of the NC software (system string)</b>				
	10630	10	-	This string corresponds to the format of the version ID displayed, i.e. <b>340590 07</b> or <b>817601 04 SP1</b> .
<b>Read data of the current tool (system string)</b>				
	10950	1	-	Current tool name.

**Example: Assign the value of the active scaling factor for the Z axis to Q25.**

```
55 FN 18: SYSREAD Q25 = ID210 NR4 IDX3
```

**FN 19: PLC – Transfer values to the PLC****NOTICE****Danger of collision!**

Changes to the PLC can result in undesired behavior and serious errors (e.g., inoperability of the control). For this reason, access to the PLC is protected by password. The FN function provides HEIDENHAIN as well as your machine tool builder and suppliers the ability to communicate with the PLC from an NC program. It is not recommended that the machine operator or NC programmer use this. There is risk of collision during the execution of the function and during the subsequent processing!

- ▶ Only use the function in consultation with HEIDENHAIN, the machine tool builder, or the supplier.
- ▶ Comply with the documentation from HEIDENHAIN, the machine tool builder, and suppliers.

The **FN 19: PLC** function transfers up to two numerical values or Q parameters to the PLC.

## FN 20: WAIT FOR – NC and PLC synchronization

### NOTICE

#### Danger of collision!

Changes to the PLC can result in undesired behavior and serious errors (e.g., inoperability of the control). For this reason, access to the PLC is protected by password. The FN function provides HEIDENHAIN as well as your machine tool builder and suppliers the ability to communicate with the PLC from an NC program. It is not recommended that the machine operator or NC programmer use this. There is risk of collision during the execution of the function and during the subsequent processing!

- ▶ Only use the function in consultation with HEIDENHAIN, the machine tool builder, or the supplier.
- ▶ Comply with the documentation from HEIDENHAIN, the machine tool builder, and suppliers.

With the **FN 20: WAIT FOR** function you can synchronize the NC and PLC during a program run. The NC stops machining until the condition that you have programmed in the **FN 20: WAIT FOR** block is fulfilled.

**SYNC** is used whenever you read, for example, system data via **FN 18: SYSREAD** that require synchronization with real time. The control stops the look-ahead calculation and executes the following NC block only when the NC program has actually reached that block.

#### Example: Pause internal look-ahead calculation, read current position in the X axis

```
32 FN 20: WAIT FOR SYNC
```

```
33 FN 18: SYSREAD Q1 = ID270 NR1 IDX1
```

**FN 29: PLC – Transfer values to the PLC****NOTICE****Danger of collision!**

Changes to the PLC can result in undesired behavior and serious errors (e.g., inoperability of the control). For this reason, access to the PLC is protected by password. The FN function provides HEIDENHAIN as well as your machine tool builder and suppliers the ability to communicate with the PLC from an NC program. It is not recommended that the machine operator or NC programmer use this. There is risk of collision during the execution of the function and during the subsequent processing!

- ▶ Only use the function in consultation with HEIDENHAIN, the machine tool builder, or the supplier.
- ▶ Comply with the documentation from HEIDENHAIN, the machine tool builder, and suppliers.

The **FN 29: PLC** function transfers up to eight numerical values or Q parameters to the PLC.

**FN 37: EXPORT****NOTICE****Danger of collision!**

Changes to the PLC can result in undesired behavior and serious errors (e.g., inoperability of the control). For this reason, access to the PLC is protected by password. The FN function provides HEIDENHAIN as well as your machine tool builder and suppliers the ability to communicate with the PLC from an NC program. It is not recommended that the machine operator or NC programmer use this. There is risk of collision during the execution of the function and during the subsequent processing!

- ▶ Only use the function in consultation with HEIDENHAIN, the machine tool builder, or the supplier.
- ▶ Comply with the documentation from HEIDENHAIN, the machine tool builder, and suppliers.

You need the **FN 37: EXPORT** function if you want to create your own cycles and integrate them in the control.

**FN 38: SEND – Send information from NC program**

The function **FN 38: SEND** enables you to write texts and Q parameter values to the log from the NC program and send to a DNC application.

Data transmission is through a standard TCP/IP computer network.



For more detailed information, consult the Remo Tools SDK manual.

**Example**

Document values from Q1 and Q23 in the log.

```
FN 38: SEND /"Q parameter Q1: %f Q23: %f" / +Q1 / +Q23
```



## 10.9 Accessing tables with SQL commands

### Introduction



If you would like to access numerical or alphanumeric content in a table or manipulate the table (e.g., rename columns or rows), then use the SQL commands available to you.

The syntax of the SQL commands available on the control is heavily influenced by the SQL programming language—but does not conform to it completely. In addition, the control does not support the entire scope of the SQL language.

The names of tables and table columns must start with a letter and must not contain an arithmetic operator (e.g., +). Due to SQL commands, these characters can cause problems when inputting data or reading it out.

The following terms will be used (along with others) in the following:

- “SQL command” refers to the available soft keys
- “SQL instructions” describe miscellaneous functions that are entered manually as part of the syntax
- In the syntax, **HANDLE** stands for a transaction (followed by the identifying parameter)
- The **Result set** contains the query result (referred to in the following as “intermediate memory”)

Read and write access to individual numerical values of a table can likewise be carried out using the function **FN 26: TABOPEN**, **FN 27: TABWRITE** and **FN 28: TABREAD**.

**Further information:** “Freely definable tables”, page 518

In the NC software, access to tables is gained via an SQL server. This server is controlled with the available SQL commands. The SQL commands can be defined directly in an NC program.

The saver is based on a transaction model. A **transaction** is made up of multiples steps that are executed together, thereby ensuring an orderly and defined processing of the table entries.

## Transaction

Example of an SQL transaction:

- Assign Q parameters to table columns for read or write access using **SQL BIND**
- Select data using **SQL SELECT** or **SQL EXECUTE** with the **SELECT** instruction
- Read, change, or add data using **SQL FETCH**, **SQL UPDATE**, and **SQL INSERT**
- Confirm or discard interaction using **SQL COMMIT** and **SQL ROLLBACK**
- Approve bindings between table columns and Q parameters using **SQL BIND**



You must conclude all transactions that have been started—even exclusively read accesses. Concluding the transaction is the only way to ensure that changes and additions are transferred, that locks are removed, and that used resources are released.

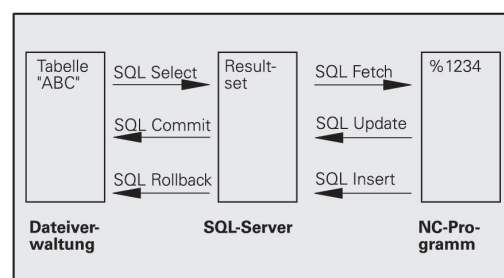

## Overview of functions

### Overview of soft keys

Soft key	Command	Page
SQL BIND	<b>SQL BIND</b> establishes or removes connections between table columns and Q or QS parameters	429
SQL EXECUTE	<b>SQL EXECUTE</b> opens a transaction for selected table columns and table rows or enables the use of other SQL instructions (miscellaneous functions). <b>Further information:</b> "Overview of instructions", page 427	430
SQL FETCH	<b>SQL FETCH</b> transfers the values to the bound Q parameters	433
SQL ROLLBACK	<b>SQL ROLLBACK</b> discards all changes and concludes the transaction	437
SQL COMMIT	<b>SQL COMMIT</b> saves all changes and concludes the transaction	436
SQL UPDATE	<b>SQL UPDATE</b> transfers all values from the bound Q parameters to the table	434
SQL INSERT	<b>SQL INSERT</b> creates a new table row	435
SQL SELECT	<b>SQL SELECT</b> reads out a single values from a table and does not open any transaction	438

**Overview of instructions**

The following so-called SQL instructions are used in the SQL command **SQL EXECUTE**.





**Further information:** "SQL EXECUTE", page 430

Instruction	Function
<b>SELECT</b>	Select data
<b>CREATE SYNONYM</b>	Create synonym (replace long path names with short names)
<b>DROP SYNONYM</b>	Delete synonym
<b>CREATE TABLE</b>	Generate a table
<b>COPY TABLE</b>	Copying a table
<b>RENAME TABLE</b>	Rename table
<b>DROP TABLE</b>	Delete the table
<b>INSERT</b>	Inserting table rows
<b>DELETE</b>	Delete table rows
<b>ALTER TABLE</b>	<ul style="list-style-type: none"> <li>■ Add table columns using <b>ADD</b></li> <li>■ Delete table columns using <b>DROP</b></li> </ul>
<b>RENAME COLUMN</b>	Rename table columns

**Programming SQL commands**

 This function is not enabled until the code number **555343** is entered.

You can program SQL commands in the **Programming** operating mode or in **Positioning with mdi**:

-  ▶ Press the **SPEC FCT** key
-  ▶ Press the **PROGRAM FUNCTIONS** soft key
-  ▶ Shift the soft-key row
-  ▶ Press the **SQL** soft key
- ▶ Select the SQL command via soft key

 Read and write accesses performed with the help of SQL commands always occur in metric units, regardless of the unit of measure selected for the table or the NC program.

If, for example, a length is saved from one table to a Q parameter, then the value is thereafter always in metric units. If this value is then use in an inch program for the purpose of positioning (**L X+Q1800**), then an incorrect position will be the result.

## Application example

In the following example, the defined material will be read out from the table (**MILL.TAB**) and saved as text in a QS parameter. The following example shows a possible application and the necessary program steps.



You can continue to use texts from QS parameters in separate log files, for example, by using the function **FN16**.

**Further information:** "FN16: F-PRINT – Formatted output of texts and Q parameter values", page 385

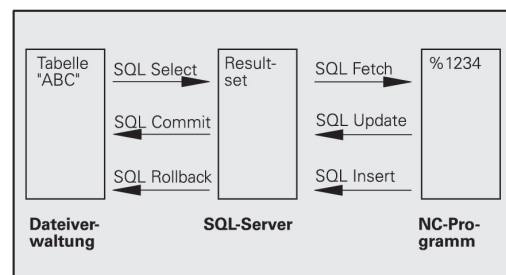

## Example

0	BEGIN PGM SQL MM	
1	SQL Q1800 "CREATE SYNONYM my_table FOR 'TNC:\table\MILL.TAB'"	Create synonym
2	SQL BIND QS1800 "my_table.WMAT"	Bind QS parameters
3	SQL QL1 "SELECT WMAT FROM my_table WHERE NO>=3"	Define search
4	SQL FETCH Q1900 HANDLE QL1	Execute search
5	SQL ROLLBACK Q1900 HANDLE QL1	Complete transaction
6	SQL BIND QS1800	Remove parameter binding
7	SQL Q1 "DROP SYNONYM my_table"	Delete synonym
8	END PGM SQL MM	

Step	Explanation
1 Create synonym	<p>A synonym is assigned to a path (long path names are replaced by short names)</p> <ul style="list-style-type: none"> <li>The path <b>TNC:\table\MILL.TAB</b> must contained in single quotation marks for this.</li> <li>The selected synonym is <b>my_table</b></li> </ul>
2 Bind QS parameters	<p>A QS parameter is bound to a table column</p> <ul style="list-style-type: none"> <li><b>QS1800</b> is freely available in user programs</li> <li>The synonym replaces the entry of the complete path</li> <li>The defined column from the table is called <b>WMAT</b></li> </ul>
3 Define search	<p>A search definition contains the entry of the transfer value</p> <ul style="list-style-type: none"> <li>The <b>QL1</b> local parameter (freely selectable) serves to identify the transaction (multiple transactions are possible simultaneously)</li> <li>The synonym defines the table</li> <li>The <b>WMAT</b> entry defines the table column of the read operation</li> <li>The entries <b>NO</b> and <b>=3</b> define the table rows of the read operation</li> <li>Selected table columns and rows define the cells of the read operation</li> </ul>
4 Execute search	<p>The read operation is executed</p> <ul style="list-style-type: none"> <li>The <b>Q1900</b> parameter is only important for the transaction (return value if needed for checking) <ul style="list-style-type: none"> <li><b>0</b> successful read operation</li> <li><b>1</b> faulty read operation</li> </ul> </li> <li>The <b>HANDLE QL1</b> syntax is the transaction designated by the <b>QL1</b> parameter</li> <li>The value is copied from the so-called <b>result set</b> (intermediate memory) to the bound parameter</li> </ul>

Step	Explanation
5 Complete transaction	The transaction is concluded and the used resources are released
6 Remove binding	The binding between table columns and QS parameters is removed (release of necessary resources)
7 Delete synonym	The synonym is deleted again (release of necessary resources)

### SQL BIND

#### Example: binding Q parameters to table columns

```
11 SQL BIND Q881 "Tab_Example.Meas_No"
12 SQL BIND Q882 "Tab_Example.Meas_X"
13 SQL BIND Q883 "Tab_Example.Meas_Y"
14 SQL BIND Q884 "Tab_Example.Meas_Z"
```

#### Example: remove binding

```
91 SQL BIND Q881
92 SQL BIND Q882
93 SQL BIND Q883
94 SQL BIND Q884
```

**SQL BIND** links a Q parameter to a table column. The SQL commands **FETCH**, **UPDATE**, and **INSERT** evaluate this binding (assignment) for the data transfer between the **result set** (intermediate memory) and the NC program.

An **SQL BIND** command without a table or column name cancels the link. The link is terminated at the end of the NC program or subprogram, if not before.

**i** Programming notes:

- You can program any number of bindings. During read and write operations, the only columns taken into consideration are those that are specified using the **SELECT** command. If you specify columns without binding in the **SELECT** command, then the control will interrupt the read or write operation with an error message.
- **SQL BIND...** must be programmed **before** the **FETCH**, **UPDATE**, and **INSERT** commands.

SQL BIND

- ▶ **Parameter no. for result:** define Q parameter for binding to the table column
- ▶ **Database: column name:** define table name and table column (separate with . )
  - **Table name:** synonym or path with filename of the table
  - **Column name:** name displayed in the table editor

## SQL EXECUTE

**SQL EXECUTE** is used in connection with various SQL instructions. **Further information:** "Overview of instructions", page 427

### SQL EXECUTE with the SQL instruction SELECT

The SQL server places the data in rows in the **result set** (intermediate memory). The rows are numbered in ascending order, starting from 0. This row number (the **INDEX**) is used for the SQL commands **FETCH** and **UPDATE**.

**SQL EXECUTE**, in combination with the SQL instruction **SELECT**, selects table values and transfers them to the **result set**. In contrast to the SQL command **SQL SELECT**, the combination of **SQL EXECUTE** and the instruction **SELECT** selects multiple columns and rows simultaneously and always opens a transaction.

In the function **SQL ... "SELECT...WHERE..."**, you can enter the search criteria. This lets you restrict the number of rows to be transferred. If you do not use this option, then all of the rows in the table are loaded.

In the function **SQL ... "SELECT...ORDER BY..."**, you can enter the ordering criterion. This entry consists of the column designation and the keyword (**ASC**) for ascending or (**DESC**) for descending order. If you do not use this option, then rows will be stored in a random order.

With the function **SQL ... "SELECT...FOR UPDATE"**, you can lock the selected rows for other applications. Other applications can continue to read these rows but are unable to change them. If you make changes to the table entries, then it is absolutely necessary to use this option.

**Empty result set:** If none of the rows correspond to the search criteria, then the SQL software returns a valid **HANDLE** (transaction) but not any table entries.

### Example: selection of table rows

```
11 SQL BIND Q881 "Tab_Example.Meas_No"
12 SQL BIND Q882 "Tab_Example.Meas_X"
13 SQL BIND Q883 "Tab_Example.Meas_Y"
14 SQL BIND Q884 "Tab_Example.Meas_Z"
...
20 SQL Q5 "SELECT Meas_no,Meas_X,Meas_Y, Meas_Z FROM
Tab_Example"
```

### Example: selection of table rows with the WHERE function

```
...
20 SQL Q5 "SELECT Meas_No,Meas_X,Meas_Y, Meas_Z FROM
Tab_Example WHERE Meas_No<20"
```

### Example: selection of table rows with the WHERE function and Q parameters

```
...
20 SQL Q5 "SELECT Meas_No,Meas_X,Meas_Y, Meas_Z FROM
Tab_Example WHERE Meas_No==:Q11"
```

**Example: table name defined with path and file name**

```
...
20 SQL Q5 "SELECT Meas_No,Meas_X,Meas_Y, Meas_Z FROM 'V:
\table\Tab_Example' WHERE Meas_No<20"
```



- ▶ **Parameter No. for result** (return value for the control):
  - **0** successful read operation
  - **1** faulty read operation
- ▶ **Database: SQL command text:** programming SQL instruction
  - **SELECT** with the table column(s) to be transferred (separate multiple columns with , )
  - **FROM** with a table's synonym or path (place the path in single quotation marks)
  - **WHERE** (optional) with column names, condition, and comparison value (Q parameters after : in single quotation marks)
  - **ORDER BY** (optional) with column names and type of ordering (**ASC** for ascending, **DESC** for descending order)
  - **FOR UPDATE** (optional) to lock write access to the selected row for other processes

**Conditions for WHERE entries**

Condition	Programming
Equals	= ==
Not equal to	!= <>
Less than	<
Less than or equal to	<=
Greater than	>
Greater than or equal to	>=
empty	IS NULL
Not empty	IS NOT NULL
<b>Linking multiple conditions:</b>	
Logical AND	AND
Logical OR	OR

### Syntax examples

The following examples are listed without context. The NC blocks are limited exclusively to the possibilities of the SQL command **SQL EXECUTE**.

#### Example

9 SQL Q1800 "CREATE SYNONYM my_table FOR 'TNC:\table\MILL.TAB'"	Create synonym
9 SQL Q1800 "DROP SYNONYM my_table"	Delete synonym
9 SQL Q1800 "CREATE TABLE my_table (NO,WMAT)"	Create table with the rows NO and WMAT.
9 SQL Q1800 "COPY TABLE my_table TO 'TNC:\table\MILL2.TAB'"	Copy table
9 SQL Q1800 "RENAME TABLE my_table TO 'TNC:\table\MILL3.TAB'"	Rename table
9 SQL Q1800 "DROP TABLE my_table"	Delete the table
9 SQL Q1800 "INSERT INTO my_table VALUES (1,'ENAW',240)"	Insert table row
9 SQL Q1800 "DELETE FROM my_table WHERE NO==3"	Delete table row
9 SQL Q1800 "ALTER TABLE my_table ADD (WMAT2)"	Insert table rows
9 SQL Q1800 "ALTER TABLE my_table DROP (WMAT2)"	Delete table rows
9 SQL Q1800 "RENAME COLUMN my_table (WMAT2) TO (WMAT3)"	Rename table column



## SQL FETCH

### Example: transferring row number in the Q parameter

```

11 SQL BIND Q881 "Tab_Example.Meas_No"
12 SQL BIND Q882 "Tab_Example.Meas_X"
13 SQL BIND Q883 "Tab_Example.Meas_Y"
14 SQL BIND Q884 "Tab_Example.Meas_Z"
...
20 SQL Q5 "SELECT Meas_no,Meas_X,Meas_Y, Meas_Z FROM
    Tab_Example"
...
30 SQL FETCH Q1 HANDLE Q5 INDEX+Q2
    
```

### Example: programming the row number directly

```

...
30 SQL FETCH Q1 HANDLE Q5 INDEX5
    
```

**SQL FETCH** reads a row out of the **result-set** (intermediate memory). The values of the individual cells are stored in the bound Q parameters. The transaction is defined via the **HANDLE** to be specified; the row is defined via the **INDEX**.

**SQL FETCH** takes all columns into consideration that were specified with the **SELECT** instruction (SQL command **SQL EXECUTE**).

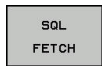

- ▶ **Parameter No. for result** (return value for the control):
  - 0 successful transaction
  - 1 successful transaction
- ▶ **Database: SQL access ID:** define Q parameters for the **HANDLE** (for identifying the transaction)
- ▶ **Database: index to SQL result:** row number within the **result set**
  - Program the row number directly
  - Program the Q parameter containing the index
  - The row (n=0) is read if nothing is specified

**i** The optional syntax elements **IGNORE UNBOUND** and **UNDEFINE MISSING** are intended for the machine tool builder.

## SQL UPDATE

### Example: transferring row number in the Q parameter

```

11 SQL BIND Q881 "TAB_EXAMPLE.MESS_NR"
12 SQL BIND Q882 "TAB_EXAMPLE.MESS_X"
13 SQL BIND Q883 "TAB_EXAMPLE.MESS_Y"
14 SQL BIND Q884 "TAB_EXAMPLE.MESS_Z"
...
20 SQL Q5 "SELECT MESS_NR,MESS_X,MESS_Y,MESS_Z FROM
    TAB_EXAMPLE"
...
30 SQL FETCH Q1 HANDLE Q5 INDEX+Q2

```

### Example: programming the row number directly

```

...
40 SQL UPDATE Q1 HANDLE Q5 INDEX5

```

**SQL UPDATE** changes a row in the **result set** (intermediate memory). The new values of the individual cells are copied from the bound Q parameters. The transaction is defined via the **HANDLE** to be specified; the row is defined via the **INDEX**. The existing row in the **result set** is completely overwritten.

**SQL UPDATE** takes all columns into consideration that were specified with the **SELECT** instruction (SQL command **SQL EXECUTE**).

SQL  
UPDATE

- ▶ **Parameter No. for result** (return value for the control):
  - 0 successful transaction
  - 1 successful transaction
- ▶ **Database: SQL access ID:** Define Q parameters for the **HANDLE** (for identifying the transaction)
- ▶ **Database: Index for SQL result:** Row number within the **result set**
  - Program the row number directly
  - Program the Q parameter containing the index
  - The row (n=0) is assigned a value if none is specified

## SQL INSERT

### Example: Transferring row number in the Q parameter

```

11 SQL BIND Q881 "Tab_Example.Meas_No"
12 SQL BIND Q882 "Tab_Example.Meas_X"
13 SQL BIND Q883 "Tab_Example.Meas_Y"
14 SQL BIND Q884 "Tab_Example.Meas_Z"
. . .
20 SQL Q5 "SELECT Meas_no,Meas_X,Meas_Y, Meas_Z FROM
    Tab_Example"
. . .
40 SQL INSERT Q1 HANDLE Q5

```

**SQL UPDATE** creates a new row in the **result set** (intermediate memory). The values of the individual cells are copied from the bound Q parameters. The transaction is defined via the **HANDLE** to be specified.

**SQL INSERT** takes all columns into consideration that were specified with the **SELECT** instruction (SQL command **SQL EXECUTE**). Table columns without corresponding **SELECT** instruction (not contained in the query result) are assigned default values.

SQL  
INSERT

- ▶ **Parameter No. for result** (return value for the control):
  - 0 successful transaction
  - 1 successful transaction
- ▶ **Database: SQL access ID**: Define Q parameters for the **HANDLE** (for identifying the transaction)

## SQL COMMIT

### Example

```

11 SQL BIND Q881 "Tab_Example.Meas_No"
12 SQL BIND Q882 "Tab_Example.Meas_X"
13 SQL BIND Q883 "Tab_Example.Meas_Y"
14 SQL BIND Q884 "Tab_Example.Meas_Z"
...
20 SQL Q5 "SELECT Meas_no,Meas_X,Meas_Y, Meas_Z FROM
    Tab_Example"
...
30 SQL FETCH Q1 HANDLE Q5 INDEX+Q2
...
40 SQL UPDATE Q1 HANDLE Q5 INDEX+Q2
...
50 SQL COMMIT Q1 HANDLE Q5

```

**SQL COMMIT** simultaneously transfers all of the rows that have been changed and added in a transaction back into the table. The transaction is defined via the **HANDLE** to be specified. A lock that was set with **SELECT...FOR UPDATE** is canceled.

The **HANDLE** (process) assigned with the instruction **SQL SELECT** becomes invalid.

SQL  
COMMIT

- ▶ **Parameter No. for result** (return value for the control):
  - **0** successful transaction
  - **1** successful transaction
- ▶ **Database: SQL access ID:** Define Q parameters for the **HANDLE** (for identifying the transaction)

## SQL ROLLBACK

### Example

```

11 SQL BIND Q881 "Tab_Example.Meas_No"
12 SQL BIND Q882 "Tab_Example.Meas_X"
13 SQL BIND Q883 "Tab_Example.Meas_Y"
14 SQL BIND Q884 "Tab_Example.Meas_Z"
. . .
20 SQL Q5 "SELECT Meas_no,Meas_X,Meas_Y, Meas_Z FROM
    Tab_Example"
. . .
30 SQL FETCH Q1 HANDLE Q5 INDEX+Q2
. . .
50 SQL ROLLBACK Q1 HANDLE Q5

```

**SQL ROLLBACK** discards all of the changes and additions of a transaction. The transaction is defined via the **HANDLE** to be specified.

The function of the SQL command **SQL ROLLBACK** depends on the **INDEX**:

- Without **INDEX**:
  - All changes and additions to the transaction are discarded
  - A lock that was set with **SELECT...FOR UPDATE** is canceled.
  - The transaction is concluded (the **HANDLE** loses its validity)
- With **INDEX**:
  - Only the indexed row remains in the **result set** (all other rows are removed)
  - Any changes and additions made in the rows that are not specified are discarded
  - A lock that has been set with **SELECT...FOR UPDATE** remains only for indexed row (all other locks are canceled)
  - The specified (indexed) row becomes the new row 0 of the **result-set**
  - The transaction is **not** concluded (the **HANDLE** keeps its validity)
  - It is necessary to later concluded the transaction using **SQL ROLLBACK** or **SQL COMMIT**

SQL  
ROLLBACK

- ▶ **Parameter No. for result** (return value for the control):
  - 0 successful transaction
  - 1 successful transaction
- ▶ **Database: SQL access ID**: Define Q parameters for the **HANDLE** (for identifying the transaction)
- ▶ **Database: Index to SQL result**: Row that remains in the **result set**
  - Program the row number directly
  - Program the Q parameter containing the index

## SQL SELECT

**SQL SELECT** reads a single value from a table and saves the result in the defined Q parameter.



You can select multiple values or columns using the SQL command **SQL EXECUTE** and the **SELECT** instruction.

**Further information:** "SQL EXECUTE", page 430

With **SQL SELECT**, there is neither a transaction nor binding between the table columns and Q parameter. Any existing bindings to the specified columns are not taken into consideration; only the read-out value is copied into the parameter specified for the result.

### Example: Reading and saving a value

```
20 SQL SELECT Q5 "SELECT Meas_X FROM Tab_Example WHERE
    MEAS_NO==3"
```

SQL  
SELECT

- ▶ **Parameter No. for result:** Q parameter for saving the value
- ▶ **Database: SQL command text:** Programming SQL instruction
  - **SELECT** with the table column of the value to be transferred
  - **FROM** with a table's synonym or path (place the path in single quotation marks)
  - **WHERE** with column designation, condition and comparison value (Q parameter after **:** in single quotation marks)

The result of the subsequent NC program is identical to the application example shown previously.

**Further information:** "Application example", page 428

### Example

0	BEGIN PGM SQL MM	
1	SQL SELECT Q51800 "SELECT WMAT FROM my_table WHERE NO==3"	Read and save a value
2	END PGM SQL MM	

## 10.10 Entering formulas directly













### Entering formulas

Using soft keys, you can enter mathematical formulas containing multiple calculation operations directly into the NC program.

 ▶ Select Q-parameter functions

 ▶ Press the **FORMULA** soft key  
▶ Select **Q**, **QL**, or **QR**

The control displays the following soft keys in several soft-key rows:

Soft key	Linking function
	<b>Addition</b> e.g., $Q10 = Q1 + Q5$
	<b>Subtraction</b> e.g., $Q25 = Q7 - Q108$
	<b>Multiplication</b> e.g., $Q12 = 5 * Q5$
	<b>Division</b> e.g., $Q25 = Q1 / Q2$
	<b>Opening parenthesis</b> e.g., $Q12 = Q1 * (Q2 + Q3)$
	<b>Closing parenthesis</b> e.g., $Q12 = Q1 * (Q2 + Q3)$
	<b>Square the value</b> e.g., $Q15 = SQ 5$
	<b>Calculate square root</b> e.g., $Q22 = SQRT 25$
	<b>Sine of an angle</b> e.g., $Q44 = SIN 45$
	<b>Cosine of an angle</b> e.g., $Q45 = COS 45$
	<b>Tangent of an angle</b> e.g., $Q46 = TAN 45$
	<b>Arc sine</b> Inverse function of the sine; determine the angle from the ratio of the opposite side to the hypotenuse e.g., $Q10 = ASIN 0.75$
	<b>Arc cosine</b> Inverse function of the cosine; determine the angle from the ratio of the adjacent side to the hypotenuse e.g., $Q11 = ACOS Q40$

Soft key	Linking function
ATAN	<b>Arc tangent</b> Inverse function of the tangent; determine the angle from the ratio of the opposite side to the adjacent side e.g., $Q12 = ATAN Q50$
^	<b>Powers of values</b> e.g., $Q15 = 3^3$
PI	<b>Constant PI (3,14159)</b> e.g., $Q15 = PI$
LN	<b>Calculate the natural logarithm of a number</b> Base 2,7183 e.g., $Q15 = LN Q11$
LOG	<b>Logarithm of a number, Base 10</b> e.g., $Q33 = LOG Q22$
EXP	<b>Exponential function, 2.7183 to the power of n</b> e.g., $Q1 = EXP Q12$
NEG	<b>Negate values (multiply by -1)</b> e.g., $Q2 = NEG Q1$
INT	<b>Remove digits after the decimal point</b>  Calculate an integer e.g., $Q3 = INT Q42$
ABS	<b>Absolute value of a number</b> e.g., $Q4 = ABS Q22$
FRAC	<b>Remove digits before the decimal point</b> Calculate a fraction e.g., $Q5 = FRAC Q23$
SGN	<b>Check algebraic sign of a number</b> e.g., $Q12 = SGN Q50$ When return value $Q12 = 0$ , then $Q50 = 0$ When return value $Q12 = 1$ , then $Q50 > 0$ When return value $Q12 = -1$ , then $Q50 < 0$
%	<b>Calculate modulo value (division remainder)</b> e.g., $Q12 = 400 \% 360$ result: $Q12 = 40$



## Rules for formulas

Mathematical formulas are programmed according to the following rules:

### Higher-level operations are performed first

#### Example

$$12 \quad Q1 = 5 * 3 + 2 * 10 = 35$$

- 1 Calculation  $5 * 3 = 15$
- 2 Calculation  $2 * 10 = 20$
- 3 Calculation  $15 + 20 = 35$

or

#### Example

$$13 \quad Q2 = SQ 10 - 3^3 = 73$$

- 1 Calculation step 10 squared = 100
- 2 Calculation step 3 to the third power = 27
- 3 Calculation  $100 - 27 = 73$



### Distributive law

Law of distribution with parentheses calculation

$$a * (b + c) = a * b + a * c$$







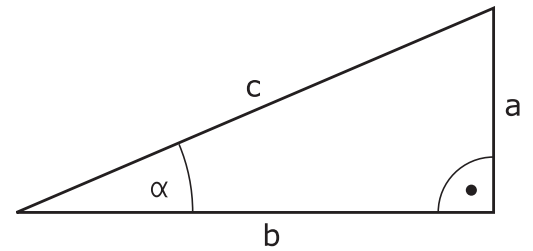

## Example of entry

Calculate an angle with the arc tangent from the opposite side (Q12) and adjacent side (Q13); then store in Q25.

- ▶  Select the formula entry function: Press the **Q** key and the **FORMULA** soft key, or use the shortcut
- ▶  Press the **Q** key on the ASCII keyboard



## PARAMETER NUMBER FOR RESULT?

- ▶  Enter **25** (parameter number) and press the **ENT** key
- ▶  Shift the soft-key row and select the arc tangent function
- ▶  Advance through the soft key menu and press the **OPENING PARENTHESIS** soft key
- ▶  Enter **12** (Q parameter number)
- ▶  Select division
- ▶  Enter **13** (Q parameter number)
- ▶  Close parentheses and conclude formula entry
- ▶  **END**

## Example

**37 Q25 = ATAN (Q12/Q13)**

## 10.11 String parameters

### String processing functions

You can use the **QS** parameters to create variable character strings. You can output such character strings for example through the **FN 16:F-PRINT** function to create variable logs.

You can assign a linear sequence of characters (letters, numbers, special characters and spaces) up to a length of 255 characters to a string parameter. You can also check and process the assigned or imported values using the functions described below. As in Q parameter programming, you can use a total of 2000 QS parameters.

**Further information:** "Principle and overview of functions", page 366

The **STRING FORMULA** and **FORMULA** Q parameter functions contain various functions for processing the string parameters.

Soft key	Functions of the STRING FORMULA	Page
STRING	Assigning string parameters	444
CFGREAD	Read out machine parameter	453
	Chain-linking string parameters	444
TOCHAR	Converting a numerical value to a string parameter	446
SUBSTR	Copy a substring from a string parameter	447
SVSSTR	Read system data	448





Soft key	Formula string functions	Page
TONUMB	Converting a string parameter to a numerical value	449
INSTR	Checking a string parameter	450
STRLEN	Finding the length of a string parameter	451
STRCOMP	Compare alphabetic priority	452



When you use the **STRING FORMULA** function, the result of the arithmetic operation is always a string. When you use the **FORMULA** function, the result of the arithmetic operation is always a numeric value.

## Assign string parameters

Before using string variables, you must first assign the variables. Use the **DECLARE STRING** command to do so.





-  ▶ Press the **SPEC FCT** key
-  ▶ Press the **PROGRAM FUNCTIONS** soft key
-  ▶ Press the **STRING FUNCTIONS** soft key
-  ▶ Press the **DECLARE STRING** soft key

### Example

```
37 DECLARE STRING QS10 = "Workpiece"
```

## Chain-linking string parameters

With the concatenation operator (string parameter || string parameter) you can make a chain of two or more string parameters.

- 
  - ▶ Press the **SPEC FCT** key
- 
  - ▶ Press the **PROGRAM FUNCTIONS** soft key
- 
  - ▶ Press the **STRING FUNCTIONS** soft key
- 
  - ▶ Press the **STRING FORMULA** soft key
- 
  - ▶ Enter the number of the string parameter in which the control is to save the concatenated string. Confirm with the **ENT** key.
  - ▶ Enter the number of the string parameter in which the **first** substring is saved. Confirm with the **ENT** key
  - ▶ The control shows the concatenation symbol || an.
  - ▶ Press the **ENT** key
  - ▶ Enter the number of the string parameter in which the **second** substring is saved. Confirm with the **ENT** key
  - ▶ Repeat the process until you have selected all the required substrings. Conclude with the **END** key

**Example: QS10 is to include the complete text of QS12, QS13 and QS14**

```
37 QS10 = QS12 || QS13 || QS14
```

Parameter contents:

- **QS12: Workpiece**
- **QS13: Status:**
- **QS14: Scrap**
- **QS10: Workpiece Status: Scrap**

## Converting a numerical value to a string parameter

With the **TOCHAR** function, the control converts a numerical value into a string parameter. This enables you to chain numerical values with string variables.

SPEC  
FCT

- ▶ Show the soft-key row with special functions

PROGRAM  
FUNCTIONS

- ▶ Open the function menu

STRING  
FUNCTIONS

- ▶ Press the String functions soft key

STRING  
FORMULA

- ▶ Press the **STRING FORMULA** soft key

TOCHAR





- ▶ Select the function for converting a numerical value to a string parameter
- ▶ Enter the number or the desired Q parameter to be converted by the control, and confirm with the **ENT** key
- ▶ If desired, enter the number of digits after the decimal point that the control should convert, and confirm with the **ENT** key
- ▶ Close the parenthetical expression with the **ENT** key and confirm your entry with the **END** key

**Example: Convert parameter Q50 to string parameter QS11, use 3 decimal places**

```
37 QS11 = TOCHAR ( DAT+Q50 DECIMALS3 )
```

## Copying a substring from a string parameter

The **SUBSTR** function copies a definable range from a string parameter.

-  ▶ Show the soft-key row with special functions
-  ▶ Open the function menu
-  ▶ Press the String functions soft key
-  ▶ Press the **STRING FORMULA** soft key
- ▶ Enter the number of the string parameter in which the control is to save the character string. Confirm with the **ENT** key.
-  ▶ Select the function for cutting out a substring
- ▶ Enter the number of the QS parameter from which the substring is to be copied. Confirm with the **ENT** key
- ▶ Enter the number of the place starting from which to copy the substring, and confirm with the **ENT** key
- ▶ Enter the number of characters to be copied, and confirm with the **ENT** key
- ▶ Close the parenthetical expression with the **ENT** key and confirm your entry with the **END** key



The first character of a text string starts internally at the 0-position

**Example: A four-character substring (LEN4) is read from the string parameter QS10 beginning with the third character (BEG2)**

```
37 QS13 = SUBSTR ( SRC_QS10 BEG2 LEN4 )
```

## Reading system data

With the function **SYSSTR** you can read system data and store them in string parameters. You select the system data through a group number (ID) and a number.

Entering **IDX** and **DAT** is not required.

Group name, ID no.	Number	Meaning		
Program information, 10010	1	Path of the current main program or pallet program		
	3	Path of the cycle selected with <b>CYCL DEF 12 PGM CALL</b>		
	10	Path of the program selected with <b>SEL PGM</b>		
Channel data, 10025	1	Channel name		
Values programmed in the tool call, 10060	1	Tool name		
Current system time, 10321	1 - 16	■ 1: DD.MM.YYYY hh:mm:ss		
		■ 2 and 16: DD.MM.YYYY hh:mm		
		■ 3: DD.MM.YY hh:mm		
		■ 4: YYYY-MM-DD hh:mm:ss		
		■ 5 and 6: YYYY-MM-DD hh:mm		
		■ 7: YY-MM-DD hh:mm		
		■ 8 and 9: DD.MM.YYYY		
		■ 10: DD.MM.YY		
		■ 11: YYYY-MM-DD		
		■ 12: YY-MM-DD		
		■ 13 and 14: hh:mm:ss		
		■ 15: hh:mm		
		Touch-probe data, 10350	50	Probe type of the active touch probe TS
			70	Probe type of the active touch probe TT
			73	Key name of the active touch probe TT from MP <b>activeTT</b>
Data for pallet machining, 10510	1	Pallet name		
	2	Path of the selected pallet table		
NC software version, 10630	10	Version identifier of the NC software version		
Tool data, 10950	1	Tool name		
	2	DOC entry of the tool		
	4	Tool-carrier kinematics		



## Converting a string parameter to a numerical value

The **TONUMB** function converts a string parameter to a numerical value. The value to be converted should be only numerical.



The QS parameter to be converted must contain only one numerical value. Otherwise, the Control will output an error message..



- ▶ Select Q-parameter functions

FORMULA

- ▶ Press the **FORMULA** soft key
- ▶ Enter the number of the string parameter in which the control is to save the numerical value. Confirm with the **ENT** key.



- ▶ Shift the soft-key row

TONUMB





- ▶ Select the function for converting a string parameter to a numerical value
- ▶ Enter the number of the QS parameter to be converted by the control, and confirm with the **ENT** key
- ▶ Close the parenthetical expression with the **ENT** key and confirm your entry with the **END** key

### Example: Convert string parameter QS11 to a numerical parameter Q82

```
37 Q82 = TONUMB ( SRC_QS11 )
```

## Testing a string parameter

The **INSTR** function checks whether a string parameter is contained in another string parameter.

-  ▶ Select Q-parameter functions
- 
  - ▶ Press the **FORMULA** soft key
  - ▶ Enter the number of the Q parameter for the result and confirm with the **ENT** key
  - ▶ The control saves the place at which the text to be searched for begins. It is saved in the parameter.
-  ▶ Shift the soft-key row
- 
  - ▶ Select the function for checking a string parameter
  - ▶ Enter the number of the QS parameter in which the text to be searched for is saved. Confirm with the **ENT** key
  - ▶ Enter the number of the QS parameter to be searched for by the control, and confirm with the **ENT** key
  - ▶ Enter the number of the place at which the control is to start search the substring, and confirm with the **ENT** key.
  - ▶ Close the parenthetical expression with the **ENT** key and confirm your entry with the **END** key



The first character of a text string starts internally at the 0-position

If the control cannot find the required substring, it will save the total length of the string to be searched (counting starts at 1) in the result parameter.





If the substring to be searched for appears multiple times, then the control returns the first place at which it finds the substring.

**Example: Search through QS10 for the text saved in parameter QS13. Begin the search at the third place.**

```
37 Q50 = INSTR ( SRC_QS10 SEA_QS13 BEG2 )
```

## Finding the length of a string parameter

The **STRLEN** function returns the length of the text saved in a selectable string parameter.

- 
  - ▶ Select Q parameter function
- 
  - ▶ Press the **FORMULA** soft key
  - ▶ Enter the number of the Q parameter in which the control is to save the ascertained string length. Confirm with the **ENT** key.
- 
  - ▶ Shift the soft-key row
- 
  - ▶ Select the function for finding the text length of a string parameter
  - ▶ Enter the number of the QS parameter from which the control is to ascertain the length, and confirm with the **ENT** key
  - ▶ Close the parenthetical expression with the **ENT** key and confirm your entry with the **END** key

### Example: Find the length of QS15









```
37 Q52 = STRLEN ( SRC_QS15 )
```



If the selected string parameter is not defined the control returns the result **-1**.

## Comparing alphabetic priority

The **STRCOMP** function compares string parameters for alphabetic priority.

-  ▶ Select Q parameter function
-  ▶ Press the **FORMULA** soft key
-  ▶ Enter the number of the Q parameter in which the control is to save the result of comparison, and confirm with the **ENT** key.
-  ▶ Shift the soft-key row
-  ▶ Select the function for comparing string parameters
-  ▶ Enter the number of the first QS parameter that the control is to compare, and confirm with the **ENT** key
-  ▶ Enter the number of the second QS parameter that the control is to compare, and confirm with the **ENT** key
-  ▶ Close the parenthetical expression with the **ENT** key and confirm your entry with the **END** key



The control returns the following results:

- **0**: The compared QS parameters are identical
- **-1**: The first QS parameter **precedes** the second QS parameter alphabetically
- **+1**: The first QS parameter **follows** the second QS parameter alphabetically





### Example: QS12 and QS14 are compared for alphabetic priority

```
37 Q52 = STRCOMP ( SRC_QS12 SEA_QS14 )
```

## Reading out machine parameters

With the **CFGREAD** function, you can read out machine parameters of the control as numerical values or as strings. The read-out values are always output in metric units of measure.

In order to read out a machine parameter, you must use the control's configuration editor to determine the parameter name, parameter object, and, if they have been assigned, the group name and index:

Icon	Type	Meaning	Example
	<b>Key</b>	Group name of the machine parameter (if available)	CH_NC
	<b>Entity</b>	Parameter object (name begins with <b>Cfg...</b> )	<b>CfgGeoCycle</b>
	<b>Attribute</b>	Name of the machine parameter	<b>displaySpindleErr</b>
	<b>Index</b>	List index of a machine parameter (if available)	[0]



If you are in the configuration editor for the user parameters, you can change the display of the existing parameters. In the default setting, the parameters are displayed with short, explanatory texts.

**Further information:** "Changing the display of the parameters", page 776

Each time you want to interrogate a machine parameter with the **CFGREAD** function, you must first define a QS parameter with attribute, entity and key.

The following parameters are read in the CFGREAD function's dialog:

- **KEY\_QS**: Group name (key) of the machine parameter
- **TAG\_QS**: Object name (entity) of the machine parameter
- **ATR\_QS**: Name (attribute) of the machine parameter
- **IDX**: Index of the machine parameter

### Reading a string of a machine parameter

In order to store the content of a machine parameter as a string in a QS parameter:

- ▶ Press the **Q** key.
- ▶ Press the **STRING FORMULA** soft key
- ▶ Enter the number of the string parameter in which the control is to save the machine parameter
- ▶ Press the **ENT** key
- ▶ Select the **CFGREAD** function
- ▶ Enter the numbers of the string parameters for key, entity, and attribute
- ▶ Press the **ENT** key
- ▶ Enter the number for the index, or skip the dialog with **NNO ENT**, whichever applies
- ▶ Close the parenthesized expression with the **ENT** key
- ▶ Press the **END** key to conclude entry

**Example: Read as a string the axis designation of the fourth axis**

#### Parameter settings in the configuration editor

```

DisplaySettings
  CfgDisplayData
    axisDisplayOrder
      [0] to [5]
  
```

#### Example

14 QS11 = ""	Assign string parameter for key
15 QS12 = "CfgDisplaydata"	Assign string parameter for entity
16 QS13 = "axisDisplay"	Assign string parameter for parameter name
17 QS1 = CFGREAD( KEY_QS11 TAG_QS12 ATR_QS13 IDX3 )	Read out machine parameter

**Reading a numerical value of a machine parameter**

Store the value of a machine parameter as a numerical value in a Q parameter:

- Q** ▶ Select Q parameter function
- FORMULA**
  - ▶ Press the **FORMULA** soft key
  - ▶ Enter the number of the Q parameter in which the control is to save the machine parameter
  - ▶ Press the **ENT** key
  - ▶ Select the **CFGREAD** function
  - ▶ Enter the numbers of the string parameters for key, entity, and attribute
  - ▶ Press the **ENT** key
  - ▶ Enter the number for the index, or skip the dialog with **NNO ENT**, whichever applies
  - ▶ Close the parenthesized expression with the **ENT** key
  - ▶ Press the **END** key to conclude entry

**Example: Read overlap factor as Q parameter**

**Parameter settings in the configuration editor**

```
ChannelSettings
CH_NC
    CfgGeoCycle
        pocketOverlap
```

**Example**

14 QS11 = "CH_NC"	Assign string parameter for key
15 QS12 = "CfgGeoCycle"	Assign string parameter for entity
16 QS13 = "pocketOverlap"	Assign string parameter for parameter name
17 Q50 = CFGREAD( KEY_QS11 TAG_QS12 ATR_QS13 )	Read out machine parameter

## 10.12 Preassigned Q parameters

The Q parameters Q100 to Q199 are assigned values by the control. The following types of information are assigned to the Q parameters:

- Values from the PLC
- Tool and spindle data
- Data on operating status
- Results of measurements from touch probe cycles etc.

The control saves the preassigned Q parameters Q108, Q114 and Q115 - Q117 in the unit of measure used by the active program.

### NOTICE

#### Danger of collision!

Q parameters are used in the HEIDENHAIN cycles, in machine tool builder cycles, and in supplier functions. You can also program Q parameters within the NC program. If, when using Q parameters, the recommended Q parameter ranges are not used exclusively, then this can lead to overlapping (reciprocal effects) and thus cause undesired behavior. Danger of collision during machining!

- ▶ Only use Q parameter ranges recommended by HEIDENHAIN.
- ▶ Comply with the documentation from HEIDENHAIN, the machine tool builder, and suppliers.
- ▶ Check the machining sequence using a graphic simulation



You must not use preassigned Q parameters (QS parameters) between **Q100** and **Q199** (**QS100** and **QS199**) as calculation parameters in the NC programs.

### Values from the PLC: Q100 to Q107

The control assigns values from the PLC to parameters Q100 to Q107 in an NC program.

### Active tool radius: Q108

The active value of the tool radius is assigned to Q108. Q108 is calculated from:

- Tool radius R (tool table or **TOOL DEF** block)
- Delta value DR from the tool table
- Delta value DR from the **TOOL CALL** block



The control remembers the current tool radius even if the power is interrupted.



**Tool axis: Q109**

The value of Q109 depends on the current tool axis:

Tool axis	Parameter value
No tool axis defined	Q109 = -1
X axis	Q109 = 0
Y axis	Q109 = 1
Z axis	Q109 = 2
U axis	Q109 = 6
V axis	Q109 = 7
W axis	Q109 = 8

**Spindle status: Q110**

The value of the parameter Q110 depends on the M function last programmed for the spindle.

M function	Parameter value
No spindle status defined	Q110 = -1
M3: Spindle ON, clockwise	Q110 = 0
M4: Spindle ON, counterclockwise	Q110 = 1
M5 after M3	Q110 = 2
M5 after M4	Q110 = 3

**Coolant on/off: Q111**

M function	Parameter value
M8: Coolant ON	Q111 = 1
M9: Coolant OFF	Q111 = 0

**Overlap factor: Q112**

The control assigns Q112 to the overlap factor for pocket milling.

**Unit of measurement for dimensions in the program: Q113**

During nesting the **PGM CALL**, the value of the parameter Q113 depends on the dimensional data of the program from which the other programs are called.

Dimensional data of the main program	Parameter value
Metric system (mm)	Q113 = 0
Imperial system (inch)	Q113 = 1

### Tool length: Q114

The current value for the tool length is assigned to Q114.



The Control remembers the current tool length even if the power is interrupted.

### Coordinates after probing during program run

The parameters Q115 to Q119 contain the coordinates of the spindle position at the moment of contact during programmed measurement with the 3-D touch probe. The coordinates refer to the preset that is active in the **Manual operation** mode.

The length of the stylus and the radius of the ball tip are not compensated in these coordinates.

Coordinate axis	Parameter value
X axis	Q115
Y axis	Q116
Z axis	Q117
4th axis Machine-dependent	Q118
5th axis Machine-dependent	Q119

### Deviation between actual value and nominal value during automatic tool measurement with, for example, the TT 160

Deviation of actual from nominal value	Parameter value
Tool length	Q115
Tool radius	Q116

### Tilting the working plane with spatial (workpiece) angles instead of spindle head angles: Coordinates for rotary axes calculated by the control.

Coordinates	Parameter value
A axis	Q120
B axis	Q121
C axis	Q122

## Measurement results from touch probe cycles

**Further information:** Cycle Programming User's Manual

Measured actual values	Parameter value
Angle of a straight line	Q150
Center in reference axis	Q151
Center in minor axis	Q152
Diameter	Q153
Pocket length	Q154
Pocket width	Q155
Length of the axis selected in the cycle	Q156
Position of the centerline	Q157
Angle in the A axis	Q158
Angle in the B axis	Q159
Coordinate of the axis selected in the cycle	Q160

Measured deviation	Parameter value
Center in reference axis	Q161
Center in minor axis	Q162
Diameter	Q163
Pocket length	Q164
Pocket width	Q165
Measured length	Q166
Position of the centerline	Q167

Determined space angle	Parameter value
Rotation about the A axis	Q170
Rotation about the B axis	Q171
Rotation about the C axis	Q172

Workpiece status	Parameter value
Good	Q180
Rework	Q181
Scrap	Q182

<b>Tool measurement with the BLUM laser</b>	<b>Parameter value</b>
Reserved	Q190
Reserved	Q191
Reserved	Q192
Reserved	Q193
<b>Reserved for internal use</b>	<b>Parameter value</b>
Marker for cycles	Q195
Marker for cycles	Q196
Marker for cycles (machining patterns)	Q197
Number of the last active measuring cycle	Q198
<b>Status of tool measurement with TT</b>	<b>Parameter value</b>
Tool within tolerance	Q199 = 0.0
Tool is worn (LTOL/RTOL is exceeded)	Q199 = 1.0
Tool is broken (LBREAK/RBREAK is exceeded)	Q199 = 2.0

## 10.13 Programming examples

### Example: Ellipse

#### Program run

- The contour of the ellipse is approximated by many short lines (defined in Q7). The more calculation steps you define for the lines, the smoother the curve becomes.
- The milling direction is determined with the starting angle and end angle in the plane:  
Machining direction is clockwise:  
Starting angle > end angle  
Machining direction is counterclockwise:  
Starting angle < end angle
- The tool radius is not taken into account

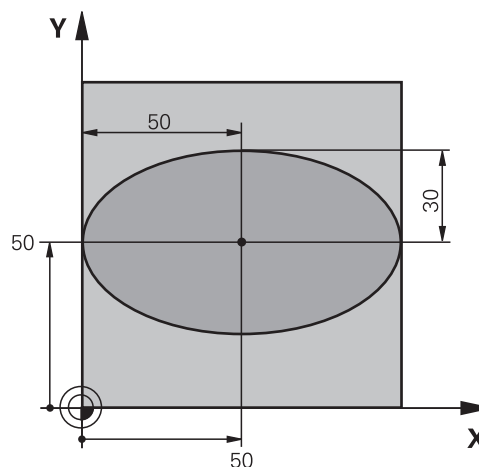

<b>0 BEGIN PGM ELLIPSE MM</b>	
<b>1 FN 0: Q1 = +50</b>	Center in X axis
<b>2 FN 0: Q2 = +50</b>	Center in Y axis
<b>3 FN 0: Q3 = +50</b>	Semiasis in X
<b>4 FN 0: Q4 = +30</b>	Semiasis in Y
<b>5 FN 0: Q5 = +0</b>	Starting angle in the plane
<b>6 FN 0: Q6 = +360</b>	End angle in the plane
<b>7 FN 0: Q7 = +40</b>	Number of calculation steps
<b>8 FN 0: Q8 = +0</b>	Rotational position of the ellipse
<b>9 FN 0: Q9 = +5</b>	Milling depth
<b>10 FN 0: Q10 = +100</b>	Feed rate for plunging
<b>11 FN 0: Q11 = +350</b>	Feed rate for milling
<b>12 FN 0: Q12 = +2</b>	Set-up clearance for pre-positioning
<b>13 BLK FORM 0.1 Z X+0 Y+0 Z-20</b>	Workpiece blank definition
<b>14 BLK FORM 0.2 X+100 Y100 Z+0</b>	
<b>15 TOOL CALL 1 Z S4000</b>	Tool call
<b>16 L Z+250 R0 FMAX</b>	Retract the tool
<b>17 CALL LBL 10</b>	Call machining operation
<b>18 L Z+100 R0 FMAX M2</b>	Retract the tool, end program
<b>19 LBL 10</b>	Subprogram 10: Machining operation
<b>20 CYCL DEF 7.0 DATUM SHIFT</b>	Shift datum to center of ellipse
<b>21 CYCL DEF 7.1 X+Q1</b>	
<b>22 CYCL DEF 7.2 Y+Q2</b>	
<b>23 CYCL DEF 10.0 ROTATION</b>	Account for rotational position in the plane
<b>24 CYCL DEF 10.1 ROT+Q8</b>	
<b>25 Q35 = (Q6 - Q5) / Q7</b>	Calculate angle increment

26 Q36 = Q5	Copy starting angle
27 Q37 = 0	Set counter
28 Q21 = Q3 *COS Q36	Calculate X coordinate for starting point
29 Q22 = Q4 *SIN Q36	Calculate Y coordinate for starting point
30 L X+Q21 Y+Q22 R0 FMAX M3	Move to starting point in the plane
31 L Z+Q12 R0 FMAX	Pre-position in spindle axis to set-up clearance
32 L Z-Q9 R0 FQ10	Move to working depth
33 LBL1	
34 Q36 = Q36 +Q35	Update the angle
35 Q37 = Q37 +1	Update the counter
36 Q21 = Q3 *COS Q36	Calculate the current X coordinate
37 Q22 = Q4 *SIN Q36	Calculate the current Y coordinate
38 L X+Q21 Y+Q22 R0 FQ11	Move to next point
39 FN 12: IF +Q37 LT +Q7 GOTO LBL 1	Unfinished? If not finished, return to LBL 1
40 CYCL DEF 10.0 ROTATION	Reset the rotation
41 CYCL DEF 10.1 ROT+0	
42 CYCL DEF 7.0 DATUM SHIFT	Reset the datum shift
43 CYCL DEF 7.1 X+0	
44 CYCL DEF 7.2 Y+0	
45 L Z+Q12 R0 FMAX	Move to set-up clearance
46 LBL 0	End of subprogram
47 END PGM ELLIPSE MM	

## Example: Concave cylinder machined with spherical cutter

Program run

- This program functions only with a spherical cutter. The tool length refers to the sphere center.
- The contour of the cylinder is approximated by many short line segments (defined in Q13). The more line segments you define, the smoother the curve becomes.
- The cylinder is milled in longitudinal cuts (here: parallel to the Y axis).
- The milling direction is determined with the starting angle and end angle in space:  
 Machining direction clockwise:  
 Starting angle > end angle  
 Machining direction counterclockwise:  
 Starting angle < end angle
- The tool radius is compensated automatically

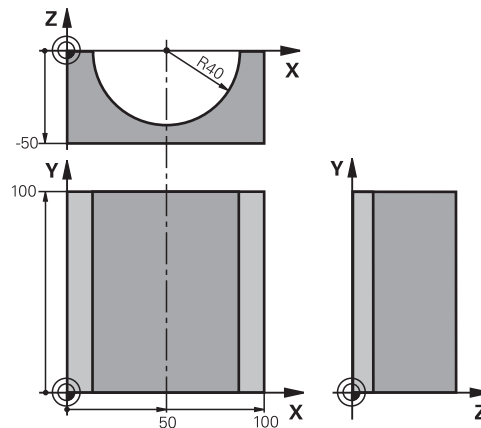

<b>0 BEGIN PGM CYLIN MM</b>	
<b>1 FN 0: Q1 = +50</b>	Center in X axis
<b>2 FN 0: Q2 = +0</b>	Center in Y axis
<b>3 FN 0: Q3 = +0</b>	Center in Z axis
<b>4 FN 0: Q4 = +90</b>	Starting angle in space (Z/X plane)
<b>5 FN 0: Q5 = +270</b>	End angle in space (Z/X plane)
<b>6 FN 0: Q6 = +40</b>	Cylinder radius
<b>7 FN 0: Q7 = +100</b>	Length of the cylinder
<b>8 FN 0: Q8 = +0</b>	Rotational position in the X/Y plane
<b>9 FN 0: Q10 = +5</b>	Allowance for cylinder radius
<b>10 FN 0: Q11 = +250</b>	Feed rate for plunging
<b>11 FN 0: Q12 = +400</b>	Feed rate for milling
<b>12 FN 0: Q13 = +90</b>	Number of cuts
<b>13 BLK FORM 0.1 Z X+0 Y+0 Z-50</b>	Definition of workpiece blank
<b>14 BLK FORM 0.2 X+100 Y+100 Z+0</b>	
<b>15 TOOL CALL 1 Z S4000</b>	Tool call
<b>16 L Z+250 R0 FMAX</b>	Retract the tool
<b>17 CALL LBL 10</b>	Call machining operation
<b>18 FN 0: Q10 = +0</b>	Reset allowance
<b>19 CALL LBL 10</b>	Call machining operation
<b>20 L Z+100 R0 FMAX M2</b>	Retract the tool, end program

21 LBL 10	Subprogram 10: Machining operation
22 Q16 = Q6 -Q10 - Q108	Account for allowance and tool, based on the cylinder radius
23 FN 0: Q20 = +1	Set counter
24 FN 0: Q24 = +Q4	Copy starting angle in space (Z/X plane)
25 Q25 = (Q5 -Q4) / Q13	Calculate angle increment
26 CYCL DEF 7.0 DATUM SHIFT	Shift datum to center of cylinder (X axis)
27 CYCL DEF 7.1 X+Q1	
28 CYCL DEF 7.2 Y+Q2	
29 CYCL DEF 7.3 Z+Q3	
30 CYCL DEF 10.0 ROTATION	Account for rotational position in the plane
31 CYCL DEF 10.1 ROT+Q8	
32 L X+0 Y+0 R0 FMAX	Pre-position in the plane to the cylinder center
33 L Z+5 R0 F1000 M3	Pre-position in the spindle axis
34 LBL 1	
35 CC Z+0 X+0	Set pole in the Z/X plane
36 LP PR+Q16 PA+Q24 FQ11	Move to starting position on cylinder, plunge-cutting obliquely into the material
37 L Y+Q7 R0 FQ12	Longitudinal cut in Y+ direction
38 FN 1: Q20 = +Q20 + +1	Update the counter
39 FN 1: Q24 = +Q24 + +Q25	Update solid angle
40 FN 11: IF +Q20 GT +Q13 GOTO LBL 99	Finished? If finished, jump to end
41 LP PR+Q16 PA+Q24 FQ11	Move on an approximated arc for the next longitudinal cut
42 L Y+0 R0 FQ12	Longitudinal cut in Y- direction
43 FN 1: Q20 = +Q20 + +1	Update the counter
44 FN 1: Q24 = +Q24 + +Q25	Update solid angle
45 FN 12: IF +Q20 LT +Q13 GOTO LBL 1	Unfinished? If not finished, return to LBL 1
46 LBL 99	
47 CYCL DEF 10.0 ROTATION	Reset the rotation
48 CYCL DEF 10.1 ROT+0	
49 CYCL DEF 7.0 DATUM SHIFT	Reset the datum shift
50 CYCL DEF 7.1 X+0	
51 CYCL DEF 7.2 Y+0	
52 CYCL DEF 7.3 Z+0	
53 LBL 0	End of subprogram
54 END PGM CYLIN	



## Example: Convex sphere machined with end mill

### Program run

- This program requires an end mill.
- The contour of the sphere is approximated by many short lines (in the Z/X plane, defined in Q14). The smaller you define the angle increment, the smoother the curve becomes.
- You can determine the number of contour cuts through the angle increment in the plane (defined in Q18).
- The tool moves upward in three-dimensional cuts.
- The tool radius is compensated automatically

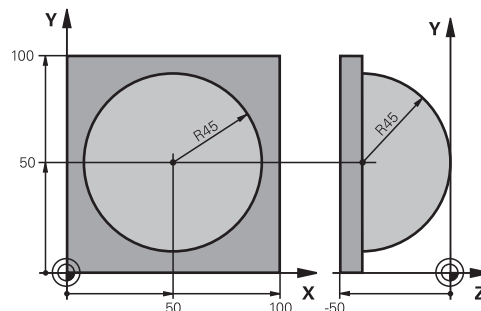

<b>0 BEGIN PGM SPHERE MM</b>	
<b>1 FN 0: Q1 = +50</b>	Center in X axis
<b>2 FN 0: Q2 = +50</b>	Center in Y axis
<b>3 FN 0: Q4 = +90</b>	Starting angle in space (Z/X plane)
<b>4 FN 0: Q5 = +0</b>	End angle in space (Z/X plane)
<b>5 FN 0: Q14 = +5</b>	Angle increment in space
<b>6 FN 0: Q6 = +45</b>	Sphere radius
<b>7 FN 0: Q8 = +0</b>	Starting angle of rotational position in the X/Y plane
<b>8 FN 0: Q9 = +360</b>	End angle of rotational position in the X/Y plane
<b>9 FN 0: Q18 = +10</b>	Angle increment in the X/Y plane for roughing
<b>10 FN 0: Q10 = +5</b>	Allowance in sphere radius for roughing
<b>11 FN 0: Q11 = +2</b>	Set-up clearance for pre-positioning in the spindle axis
<b>12 FN 0: Q12 = +350</b>	Feed rate for milling
<b>13 BLK FORM 0.1 Z X+0 Y+0 Z-50</b>	Workpiece blank definition
<b>14 BLK FORM 0.2 X+100 Y+100 Z+0</b>	
<b>15 TOOL CALL 1 Z S4000</b>	Tool call
<b>16 L Z+250 R0 FMAX</b>	Retract the tool
<b>17 CALL LBL 10</b>	Call machining operation
<b>18 FN 0: Q10 = +0</b>	Reset allowance
<b>19 FN 0: Q18 = +5</b>	Angle increment in the X/Y plane for finishing
<b>20 CALL LBL 10</b>	Call machining operation
<b>21 L Z+100 R0 FMAX M2</b>	Retract the tool, end program
<b>22 LBL 10</b>	Subprogram 10: Machining operation
<b>23 FN 1: Q23 = +q11 + +q6</b>	Calculate Z coordinate for pre-positioning
<b>24 FN 0: Q24 = +Q4</b>	Copy starting angle in space (Z/X plane)
<b>25 FN 1: Q26 = +Q6 + +Q108</b>	Compensate sphere radius for pre-positioning
<b>26 FN 0: Q28 = +Q8</b>	Copy rotational position in the plane
<b>27 FN 1: Q16 = +Q6 + -Q10</b>	Account for allowance in the sphere radius
<b>28 CYCL DEF 7.0 DATUM SHIFT</b>	Shift datum to center of sphere
<b>29 CYCL DEF 7.1 X+Q1</b>	
<b>30 CYCL DEF 7.2 Y+Q2</b>	

31 CYCL DEF 7.3 Z-Q16	
32 CYCL DEF 10.0 ROTATION	Account for starting angle of rotational position in the plane
33 CYCL DEF 10.1 ROT+Q8	
34 LBL 1	Pre-position in the spindle axis
35 CC X+0 Y+0	Set pole in the X/Y plane for pre-positioning
36 LP PR+Q26 PA+Q8 R0 FQ12	Pre-position in the plane
37 CC Z+0 X+Q108	Set pole in the Z/X plane, offset by the tool radius
38 L Y+0 Z+0 FQ12	Move to working depth
39 LBL 2	
40 LP PR+Q6 PA+Q24 FQ12	Move upward on an approximated arc
41 FN 2: Q24 = +Q24 - +Q14	Update solid angle
42 FN 11: IF +Q24 GT +Q5 GOTO LBL 2	Inquire whether an arc is finished. If not finished, return to LBL 2
43 LP PR+Q6 PA+Q5	Move to the end angle in space
44 L Z+Q23 R0 F1000	Retract in the spindle axis
45 L X+Q26 R0 FMAX	Pre-position for next arc
46 FN 1: Q28 = +Q28 + +Q18	Update rotational position in the plane
47 FN 0: Q24 = +Q4	Reset solid angle
48 CYCL DEF 10.0 ROTATION	Activate new rotational position
49 CYCL DEF 10.0 ROT+Q28	
50 FN 12: IF +Q28 LT +Q9 GOTO LBL 1	
51 FN 9: IF +Q28 EQU +Q9 GOTO LBL 1	Unfinished? If not finished, return to LBL 1
52 CYCL DEF 10.0 ROTATION	Reset the rotation
53 CYCL DEF 10.1 ROT+0	
54 CYCL DEF 7.0 DATUM SHIFT	Reset the datum shift
55 CYCL DEF 7.1 X+0	
56 CYCL DEF 7.2 Y+0	
57 CYCL DEF 7.3 Z+0	
58 LBL 0	End of subprogram
59 END PGM SPHERE MM	

# 11

**Miscellaneous  
Functions**

## 11.1 Entering miscellaneous functions M and STOP

### Fundamentals

With the control's miscellaneous functions—also called M functions—you can affect:

- the program run, e.g. a program interruption
- the machine functions, such as switching spindle rotation and coolant supply on and off
- the path behavior of the tool

You can enter up to four M (miscellaneous) functions at the end of a positioning block or in a separate block. The control displays the following dialog question: **Miscellaneous function M ?**

You usually enter only the number of the miscellaneous function in the programming dialog. Some miscellaneous functions can be programmed with additional parameters. In this case, the dialog is continued for the parameter input.

In the **Manual operation** and **Electronic handwheel** operating modes, the M functions are entered with the **M** soft key.

### Effectiveness of miscellaneous functions

Please note that some M functions become effective at the start of a positioning block, and others at the end, regardless of their position in the NC block.

M functions come into effect in the block in which they are called.

Some miscellaneous functions are effective only in the block in which they are programmed. Unless the miscellaneous function is only effective blockwise, you must either cancel it in a subsequent block with a separate M function, or it is automatically canceled by the control at the end of the program.



If multiple functions were programmed in a single NC block, the execution sequence is as follows:

- M functions taking effect at the start of the block are executed before those taking effect at the end of the block
- If all M functions are effective at the start or end of the block, execution takes place in the sequence as programmed

### Entering a miscellaneous function in a STOP block

If you program a **STOP** block, the program run or test run is interrupted at the block, e.g. for a tool inspection. You can also enter an M (miscellaneous) function in a **STOP** block:

STOP

- ▶ To program an interruption of program run, press the **STOP** key
- ▶ Enter a miscellaneous function **M**

### Example

87 STOP M6

## 11.2 Miscellaneous functions for program run inspection, spindle and coolant

### Overview



Refer to your machine manual.  
The machine manufacturer can influence the behavior of the miscellaneous functions described below.

M	Effect	Effective at block	Start	End
<b>M0</b>	Program STOP Spindle STOP			■
<b>M1</b>	Optional program STOP Spindle STOP if necessary Coolant OFF if necessary (function defined by the machine tool builder)			■
<b>M2</b>	STOP program run Spindle STOP Coolant off Return jump to block 1 Clear status display Functional scope depends on machine parameter <b>resetAt</b> (no. 100901)			■
<b>M3</b>	Spindle ON clockwise		■	
<b>M4</b>	Spindle ON counterclockwise		■	
<b>M5</b>	Spindle STOP			■
<b>M6</b>	Tool change Spindle STOP Program STOP			■
<b>M8</b>	Coolant ON		■	
<b>M9</b>	Coolant OFF			■
<b>M13</b>	Spindle ON clockwise Coolant ON		■	
<b>M14</b>	Spindle ON counterclockwise Coolant ON		■	
<b>M30</b>	Same as M2			■

## 11.3 Miscellaneous functions for coordinate entries

### Programming machine-referenced coordinates: M91/M92

#### Scale datum

On the scale, a reference mark indicates the position of the scale datum.

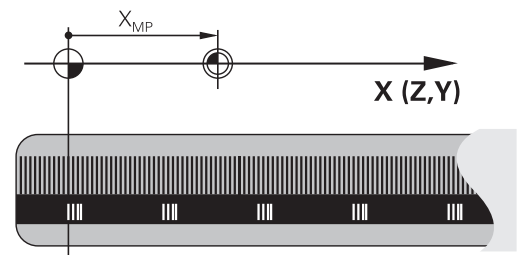

#### Machine datum

The machine datum is required for the following tasks:

- Define the axis traverse limits (software limit switches)
- Approach machine-referenced positions (e.g. tool change positions)
- Set a workpiece preset

The distance in each axis from the scale datum to the machine datum is defined by the machine manufacturer in a machine parameter.

#### Standard behavior

The control references the coordinates to the workpiece datum.

**Further information:** "Presetting without a 3-D touch probe", page 652

#### Behavior with M91 – Machine datum

If you want the coordinates in a positioning block to be referenced to the machine datum, end the block with M91.



If you program incremental coordinates in an M91 block, enter them with respect to the last programmed M91 position. If no M91 position is programmed in the active NC block, then enter the coordinates with respect to the current tool position.

The coordinate values on the control screen reference the machine datum. Switch the display of coordinates in the status display to REF.

**Further information:** "Status displays", page 94

### Behavior with M92 – Additional machine reference point



Refer to your machine manual.

In addition to the machine datum, the machine tool builder can also define an additional machine-based position as a machine reference point.

For each axis, the machine tool builder defines the distance between the machine reference point and the machine datum.

If you want the coordinates in positioning blocks to be based on the additional machine reference point, end these block with M92.



Radius compensation remains the same in blocks that are programmed with **M91** or **M92**. The tool length will **not** be taken into account.

### Effect

M91 and M92 are effective only in the blocks in which M91 and M92 have been programmed.

M91 and M92 take effect at the start of block.

### Workpiece preset

If you want the coordinates to always be referenced to the machine datum, you can disable the setting of presets for one or more axes.

If presetting is inhibited for all axes, the control no longer displays the **SET PRESET** soft key in the **Manual operation** mode.

The figure shows coordinate systems with the machine and workpiece datum.

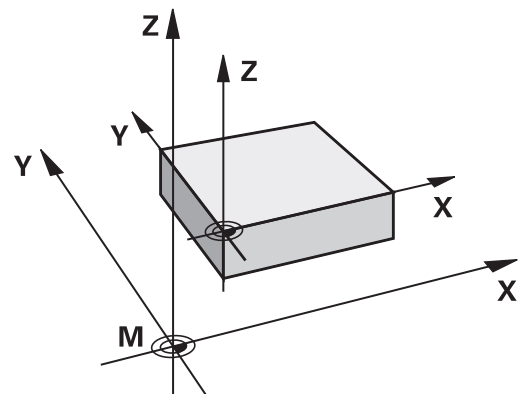

### M91/M92 in the Test Run mode

In order to be able to graphically simulate M91/M92 movements, you need to activate working space monitoring and display the workpiece blank referenced to the defined preset.

**Further information:** "Showing the workpiece blank in the working space (option 20)", page 710



## Moving to positions in a non-tilted coordinate system with a tilted working plane: M130

### Standard behavior with a tilted working plane

The control references the coordinates in the positioning blocks to the tilted working plane coordinate system.

### Behavior with M130

Despite an active tilted working plane, the control references the coordinates in straight line blocks to the non-tilted workpiece coordinate system.

The control then positions the tilted tool at the programmed coordinates of the non-tilted workpiece coordinate system.

### NOTICE

#### Danger of collision!

The **M130** function is only active blockwise. The control executes the subsequent machining operations in the tilted working plane coordinate system again. Danger of collision during machining!

- ▶ Check the sequence and positions using a graphic simulation



Programming notes:

- The **M130** function is only allowed if the **Tilt the working plane** function is active.
- If the **M130** function is combined with a cycle call, the control will interrupt the execution with an error message.

### Effect

**M130** functions blockwise in straight-line blocks without tool radius compensation.

## 11.4 Miscellaneous functions for path behavior

### Machining small contour steps: M97

#### Standard behavior

The control inserts a transition arc at outside corners. For very small contour steps, the tool would damage the contour.

In such cases, the control interrupts the program run and generates the **Tool radius too large** error message.

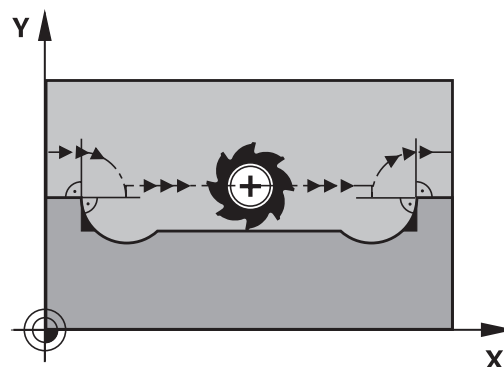

#### Behavior with M97

The control determines a path intersection for the contour elements—such as inner corners—and moves the tool above this point.

Program **M97** in the same block as the outside corner.

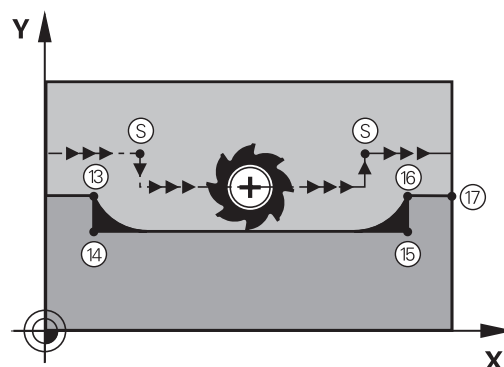

HEIDENHAIN recommends to use the much more powerful **M120 LA** function instead of **M97** here.

**Further information:** "Calculating the radius-compensated path in advance (LOOK AHEAD): M120 (Miscellaneous Functions software option)", page 479

#### Effect

The **M97** function is only effective in the NC block where it is programmed.



The control does not completely finish the corner when it is machined with **M97**. You may wish to rework the contour with a smaller tool.

#### Example

5 TOOL DEF L ... R+20	Large tool radius
...	
13 L X... Y... R... F... M97	Move to contour point 13
14 L IY-0.5 ... R... F...	Machine small contour step 13 to 14
15 L IX+100 ...	Move to contour point 15
16 L IY+0.5 ... R... F... M97	Machine small contour step 15 to 16
17 L X... Y...	Move to contour point 17

## Machining open contour corners: M98

### Standard behavior

The control calculates the intersections of the cutter paths at inside corners and moves the tool in the new direction at those points.

If the contour is open at the corners, however, this will result in incomplete machining.

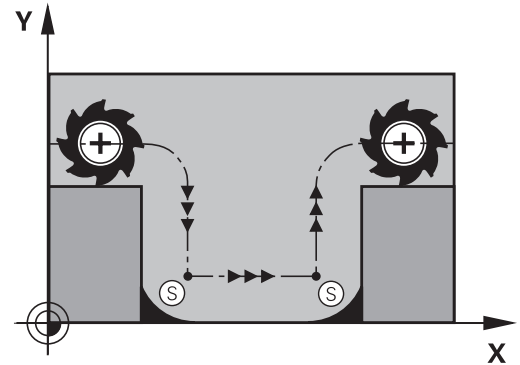

### Behavior with M98

With the **M98** miscellaneous function, the control temporarily suspends radius compensation to ensure that both corners are completely machined:

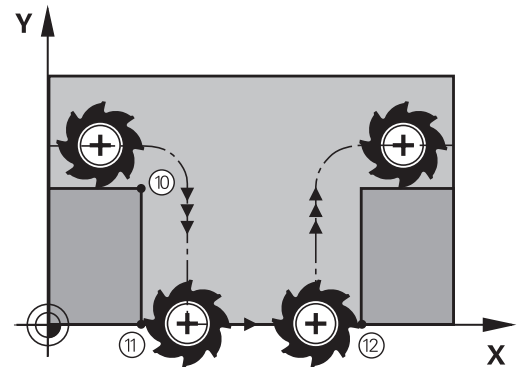

### Effect

**M98** is effective only in the blocks where it is programmed.

**M98** becomes effective at the end of the block.

**Example: Move to the contour points 10, 11 and 12 in succession**

```
10 L X... Y... RL F
```

```
11 L X... IY... M98
```

```
12 L IX+ ...
```

## Feed rate factor for plunging movements: M103

### Standard behavior

The control moves the tool at the last programmed feed rate, regardless of the direction of traverse.

### Behavior with M103

The control reduces the feed rate when the tool moves in the negative direction of the tool axis. The feed rate for plunging FZMAX is calculated from the last programmed feed rate FPROG and a factor F%:

$$FZMAX = FPROG \times F\%$$

### Programming M103

If you program **M103** in a positioning block, the control continues the dialog by prompting you for the F factor.

### Effect

**M103** becomes effective at the start of the block.

To cancel **M103**, program **M103** once again without a factor.



The **M103** is also effective with an active tilted working plane coordinate system. The feed rate reduction is then effective in the negative direction when moving the **tilted** tool axis.

### Example

The feed rate for plunging is to be 20% of the feed rate in the plane.

...	Actual contouring feed rate (mm/min):
17 L X+20 Y+20 RL F500 M103 F20	500
18 L Y+50	500
19 L IZ-2.5	100
20 L IY+5 IZ-5	141
21 L IX+50	500
22 L Z+5	500

## Feed rate in millimeters per spindle revolution: M136

### Standard behavior

The control moves the tool at the programmed F feed rate in mm/min

### Behavior with M136



In NC programs based on inch units, **M136** is not allowed in combination with the alternative **FU** feed rate. The spindle is not permitted to be controlled when M136 is active.

With **M136**, the control does not move the tool in mm/min, but rather at the programmed F feed rate in millimeters per spindle revolution. If you change the spindle speed by using the spindle override, the control changes the feed rate accordingly.

### Effect

**M136** becomes effective at the start of the block.

You can cancel **M136** by programming **M137**.

## Feed rate for circular arcs: M109/M110/M111

### Standard behavior

The control applies the programmed feed rate to the path of the tool center.

### Behavior at circular arcs with M109

For inside and outside machining of circular arcs, the control keeps the feed rate at the cutting edge constant.

### NOTICE

#### Caution: Danger to the tool and workpiece!

If the **M109** function is active, the control might dramatically increase the feed rate when machining very small outside corners. During the execution, there is a risk of tool breakage or workpiece damage.

- ▶ Do not use **M109** for machining very small outside corners

### Behavior at circular arcs with M110

With circular arcs, the control only keeps the feed rate constant for inside machining operations. The feed rate will not be adjusted for outside machining of circular arcs.



If you program **M109** or **M110** with a number > 200 before calling a machining cycle, the adjusted feed rate will also be effective for circular arcs within these machining cycles. The initial state is restored after finishing or canceling a machining cycle.

### Effect

**M109** and **M110** become effective at the start of the block. **M109** and **M110** can be canceled with **M111**.

## Calculating the radius-compensated path in advance (LOOK AHEAD): M120 (Miscellaneous Functions software option)

### Standard behavior

If the tool radius is larger than the contour step that needs to be machined with radius compensation, the control interrupts program run and generates an error message. **M97** inhibits the error message, but this results in dwell marks and will also move the corner.

**Further information:** "Machining small contour steps: M97", page 474

The control might damage the contour in case of undercuts.

### Behavior with M120

The control checks radius-compensated contours for undercuts and tool path intersections, and calculates the tool path in advance from the current block. Areas of the contour that would be damaged by the tool will not be machined (shown darker in the figure). You can also use **M120** to calculate the tool radius compensation for digitized data or data created on an external programming system. This means that deviations from the theoretical tool radius can be compensated.

The number of blocks (99 max.) calculated in advance, can be defined with **LA (Look Ahead)** following **M120**. Note that the larger the number of blocks you choose, the higher the block processing time will be.

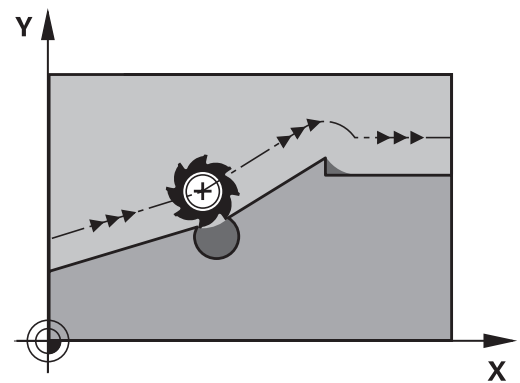

### Input

If you enter **M120** in a positioning block, the control continues the dialog for this block by prompting you for the number of **LA** blocks to be calculated in advance.

### Effect

**M120** must be included in an NC block that also contains an **RL** or **RR** radius compensation. **M120** is then effective from this block until

- radius compensation is canceled with **R0**
- **M120 LA0** is programmed
- **M120** is programmed without **LA**
- another program is called with **PGM CALL**
- the working plane is tilted with Cycle **19** or with the **PLANE** function

**M120** becomes effective at the start of the block.

### Restrictions

- After an external or internal stop, you can only re-enter the contour with the function **RESTORE POS. AT N**. Before you start the block scan, you must cancel **M120**, otherwise the control will generate an error message.
- If you want to approach the contour on a tangential path, you must use the **APPR LCT** function. The block with **APPR LCT** must contain only the coordinates of the working plane.
- If you want to depart the contour on a tangential path, you must use the function **DEP LCT**. The block with **DEP LCT** must contain only the coordinates of the working plane.
- Before using the functions listed below, you have to cancel **M120** and the radius compensation:
  - Cycle **32** Tolerance
  - Cycle **19** Working plane
  - **PLANE** function
  - **M114**
  - **M128**
  - **TCPM FUNCTION**



## Superimposing handwheel positioning during program run: M118 (software option Miscellaneous functions)

### Standard behavior

In the Program Run operating modes, the control moves the tool as defined in the NC program.

### Behavior with M118

**M118** permits manual corrections by handwheel during the program run. For this purpose, you program **M118** and enter an axis-specific value (linear or rotary axis).

### NOTICE

#### Danger of collision!

If you use the **M118** function to modify the position of a rotary axis with the handwheel and then execute the **M140** function, the control ignores the superimposed values with the retraction movement. This results in unwanted and unpredictable movements, especially when using machines with head rotation axes. There is a danger of collision during these compensating movements!

- ▶ Do not combine **M118** with **M140** when using machines with head rotation axes.

### Input

If you enter **M118** in a positioning block, the control continues the dialog for this block by prompting you for the axis-specific values. The coordinates are entered with the orange axis direction buttons or the ASCII keyboard.

### Effect

To cancel handwheel positioning, program **M118** once again without coordinate input.

**M118** becomes effective at the start of the block.

**Example**

You want to be able to use the handwheel during program run to move the tool in the working plane X/Y by  $\pm 1$  mm and in the rotary axis B by  $\pm 5^\circ$  from the programmed value:

```
L X+0 Y+38.5 RL F125 M118 X1 Y1 B5
```



**M118** is always effective in the machine coordinate system.

**Further information:** "Handwheel superimp.:", page

**M118** is also effective in the **Positioning w/ Manual Data Input** operating mode!

**Virtual tool axis VT**

Refer to your machine manual.

Your machine tool builder must have prepared the control for this function.

With the virtual tool axis, you can also traverse with the handwheel in the direction of a sloping tool on a machine with swivel heads.

To traverse in a virtual tool axis direction, select the **VT** axis on the display of your handwheel.

**Further information:** "Traverse with electronic handwheels", page 627

When using a HR 5xx handwheel, you can select the virtual axis directly with the orange **VI** axis key, if necessary.

In conjunction with the **M118** function, it is also possible to carry out handwheel superimpositioning in the currently active tool axis direction. For this purpose, program at least the spindle axis with its permitted range of traverse in the **M118** function (e.g. **M118 Z5**) and select the **VT** axis on the handwheel.

## Retraction from the contour in the tool-axis direction: M140

### Standard behavior

In the **Program Run Single Block** and **Program Run Full Sequence** operating modes, the control moves the tool as defined in the machining program.

### Behavior with M140

With **M140 MB** (move back), you can retract the tool from the contour by a programmable distance in the direction of the tool axis.

### Input

If you enter **M140** in a positioning block, the control continues the dialog and prompts you for the path the tool should use for retracting from the contour. Enter the desired path that the tool should follow when retracting from the contour, or press the **MB MAX** soft key to move to the limit of the traverse range.

In addition, you can program the feed rate at which the tool traverses the entered path. If you do not enter a feed rate, the control moves the tool along the entered path at rapid traverse.

### Effect

**M140** is effective only in the NC block in which it is programmed.

**M140** becomes effective at the start of the block.

**Example**

Block 250: Retract the tool 50 mm from the contour.

Block 251: Move the tool to the limit of the traverse range.

```
250 L X+0 Y+38.5 F125 M140 MB 50 F750
```

```
251 L X+0 Y+38.5 F125 M140 MB MAX
```



**M140** is also effective if the **Tilt working plane** function is active. For machines with swivel heads the control then moves the tool in the tilted coordinate system.

With **M140 MB MAX** you can only retract in the positive direction.

Always define a tool call with tool axis before **M140**, otherwise the traverse direction is not defined.

### NOTICE

#### **Danger of collision!**

If you use the **M118** function to modify the position of a rotary axis with the handwheel and then execute the **M140** function, the control ignores the superimposed values with the retraction movement. This results in unwanted and unpredictable movements, especially when using machines with head rotation axes. There is a danger of collision during these compensating movements!

- ▶ Do not combine **M118** with **M140** when using machines with head rotation axes.

## Suppressing touch probe monitoring: M141

### Standard behavior

If the stylus is deflected, the control issues an error message as soon as you want to move a machine axis.

### Behavior with M141

The control moves the machine axes even if the touch probe is deflected. This function is required if you wish to write your own measuring cycle in connection with measuring cycle 3 in order to retract the stylus by means of a positioning block after it has been deflected.

### NOTICE

#### Danger of collision!

The function **M141** suppresses the corresponding error message if the stylus is deflected. The control does not perform an automatic collision check with the stylus. Because of this behavior, you must check whether the touch probe can retract safely. There is a risk of collision if you choose the wrong direction for retraction.

- ▶ Carefully test the NC program or program section in the **Program run, single block** operating mode



**M141** functions only for movements with straight-line blocks.

### Effect

**M141** is effective only in the NC block in which **M141** is programmed.

**M141** becomes effective at the start of the block.

## Deleting basic rotation: M143

### Standard behavior

The basic rotation remains in effect until it is reset or is overwritten with a new value.

### Behavior with M143

The control erases a programmed basic rotation from the NC program.



The function **M143** is not permitted with mid-program startup.

### Effect

**M143** is effective only from the NC block in which it is programmed.

**M143** becomes effective at the start of the block.



**M143** deletes the entries in columns **SPA**, **SPB**, and **SPC** in the preset table; reactivating the corresponding preset table line does not activate the deleted basic rotation.

## Automatically retracting the tool from the contour at an NC stop: M148

### Standard behavior

In case of an NC stop, the control stops all traverse movements. The tool stops moving at the point of interruption.

### Behavior with M148



Refer to your machine manual.

This function must be configured and enabled by your machine tool builder.

In the **CfgLiftOff** (no. 201400) machine parameter, the machine tool builder defines the path the control is to traverse for a **LIFTOFF** command. You can also use the **CfgLiftOff** machine parameter to deactivate the function.

Set the **Y** parameter in the **LIFTOFF** column of the tool table for the active tool. The control then retracts the tool from the contour by 2 mm max. in the direction of the tool axis.

**Further information:** "Entering tool data into the table", page 234

**LIFTOFF** takes effect in the following situations:

- An NC stop triggered by you
- An NC stop triggered by the software, e.g. if an error occurred in the drive system
- When a power interruption occurs

### Effect

**M148** remains in effect until deactivated with **M149**.

**M148** becomes effective at the start of the block, **M149** at the end of the block.

## Rounding corners: M197

### Standard behavior

With active radius compensation, the control inserts a transition arc at outside corners. This may lead to rounding of that edge.

### Behavior with M197

With the **M197** function, the contour at the corner is tangentially extended and a smaller transition arc is then inserted. When you program the **M197** function and then press the **ENT** key, the control opens the **DL** input field. In **DL**, you define the length the control by which the control extends the contour elements. With **M197**, the corner radius is reduced, the corner is rounded less and the traverse movement is still smooth.

### Effect

The **M197** function acts blockwise and is only effective on outside corners.

### Example

```
L X... Y... RL M197 DL0.876
```



# 12

**Special Functions**

## 12.1 Overview of special functions

The control provides the following powerful special functions for a large number of applications:

Function	Description
Active Chatter Control (option 145)	page 498
Working with text files	page 514
Working with freely definable tables	page 518

Press the **SPEC FCT** key and the corresponding soft keys to access further special functions of the control. The following tables give you an overview of which functions are available.

### Main menu for SPEC FCT special functions

SPEC FCT

- ▶ Press the **SPEC FCT** key to select the special functions

Soft key	Function	Description
PROGRAM DEFAULTS	Define program defaults	page 491
CONTOUR + POINT MACHINING	Functions for contour and point machining	page 491
TILT MACHINING PLANE	Define the <b>PLANE</b> function	page 538
PROGRAM FUNCTIONS	Define different conversational functions	page 492
PROGRAM- MING AIDS	Programming aids	page 199



After pressing the **SPEC FCT** key, you can open the **smartSelect** selection window with the **GOTO** key. The control displays a structure overview with all available functions. You can rapidly navigate with the cursor or mouse and select functions in the tree diagram. The control displays online help for the selected function in the window on the right.

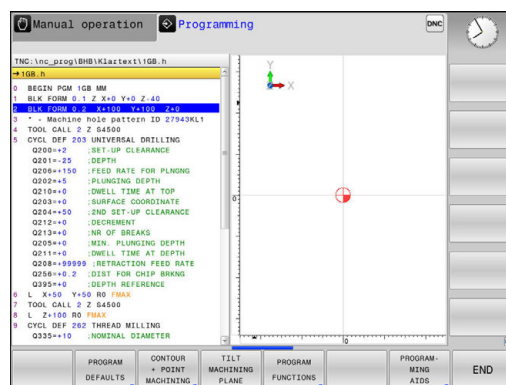

### Program defaults menu

PROGRAM  
DEFAULTS

► Press the Program Defaults soft key

Soft key	Function	Description
BLK FORM	Define workpiece blank	page 155
DATUM TABLE	Select datum table	See Cycle-Programming User's Manual
GLOBAL DEF	Define global cycle parameters	See Cycle-Programming User's Manual

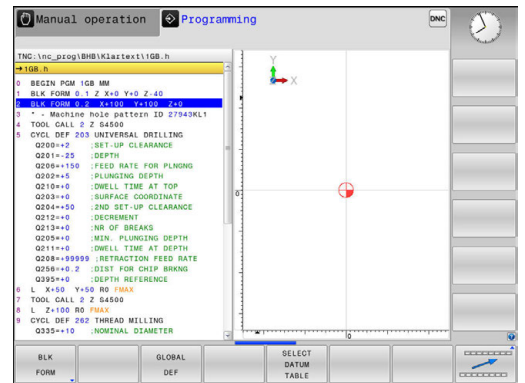

### Functions for contour and point machining menu

CONTOUR  
+ POINT  
MACHINING

► Press the soft key for functions for contour and point machining

Soft key	Function	Description
DECLARE CONTOUR	Assign contour description	See Cycle-Programming User's Manual
CONTOUR DEF	Define a simple contour formula	See Cycle-Programming User's Manual
SEL CONTOUR	Select a contour definition	See Cycle-Programming User's Manual
CONTOUR FORMULA	Define a complex contour formula	See Cycle-Programming User's Manual
PATTERN DEF	Define regular machining pattern	See Cycle-Programming User's Manual
SEL PATTERN	Select the point file with machining positions	See Cycle-Programming User's Manual

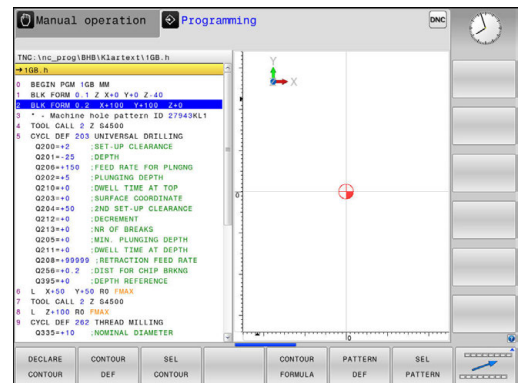

### Menu for defining different conversational functions

PROGRAM FUNCTIONS

► Press the **PROGRAM FUNCTIONS** soft key

Soft key	Function	Description
FUNCTION TCPM	Define the positioning behavior for rotary axes	page 573
FUNCTION FILE	Define file functions	page 508
FUNCTION PARAX	Define the positioning behavior for parallel axes U, V, W	page 500
TRANSFORM	Define coordinate transformations	page 509
FUNCTION COUNT	Define the counter	page 512
STRING FUNCTIONS	Define string functions	page 443
FUNCTION SPINDLE	Define pulsing spindle speed	page 524
FUNCTION FEED	Define recurring dwell time	page 526
FUNCTION DWELL	Define dwell time in seconds or revolutions	page 528
FUNCTION LIFTOFF	Lift off tool at NC stop	page 529
INSERT COMMENT	Add comments	page 201
FUNCTION PROG PATH	Choose path interpretation	page 588

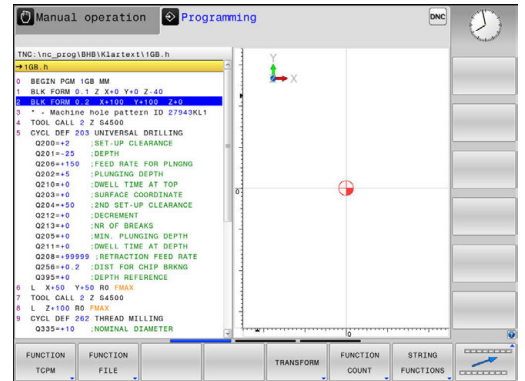

## 12.2 Tool carrier management

### Fundamentals

You can create and manage tool carriers using the tool carrier management. The control factors the tool carriers into the calculations.

On machines with 3 axes, tool carriers for right-angled angled heads help processing on tool axes **X** and **Y**, as the control takes the dimensions of the angle heads into consideration.

Along with software option number 8, **Advanced Function Set 1**, you can tilt the working plane to the angle of the removable angled heads and thus keep working with the **Z** tool axis.

You must carry out the following steps so that the control can factor the tool carriers into the calculations:

- Save tool carrier templates
- Assign input parameters to tool carriers
- Allocate parameterized tool carriers

### Save tool carrier templates

Many tool carriers only differ from others in terms of their dimensions, but their geometric shape is identical. So that you don't have to design all your tool carriers yourself, HEIDENHAIN supplies a range of ready-made tool carrier templates. Tool carrier templates are 3-D models with fixed geometries but changeable dimensions.

The tool carrier templates must be saved in **TNC:\system\Toolkinematics** and have the extension **.cft**.



If the tool carrier templates are not available in your control, please download the data you require from:  
**<http://www.klartext-portal.com/nc-solutions/en>**



If you need further tool carrier templates, please contact your machine manufacturer or third-party vendor.



The tool carrier templates may consist of several sub-files. If the sub-files are incomplete, the control will display an error message.

**Do not use incomplete tool carrier templates!**









## Assigning input parameters to tool carriers

Before the control can factor the tool carrier into the calculations, you must give the tool carrier template the actual dimensions. These parameters are entered in the additional **ToolHolderWizard** tool.

Save the parameterized tool carriers with the extension **.cfx** under **TNC:\system\Toolkinematics**.

The additional **ToolHolderWizard** tool is mainly operated with a mouse. Using the mouse, you can also set the desired screen layout by drawing a line between the areas **Parameter**, **Help graphics** and **3-D graphics** by holding down the left mouse button.

The following icons are available in the additional **ToolHolderWizard** tool:

Icon	Function
	Close tool
	Open file
	Switch between wire frame model and solid object view
	Switch between shaded and transparent view
	Display or hide transformation vectors
	Show or hide names of collision objects
	Display or hide test points
	Show or hide measurement points
	Return to starting view of the 3-D model



If the tool carrier template does not contain any transformation vectors, names, test points and measurement points, the additional **ToolHolderWizard** tool does not execute any function when the corresponding icons are activated.

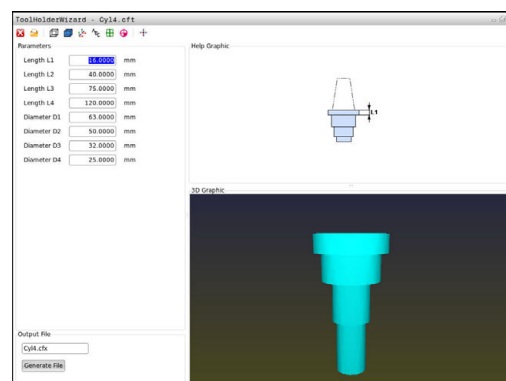

### Parameterizing the tool carrier template in the Manual operation operating mode

Proceed as follows to parameterize tool carrier templates and save these parameters:



- ▶ Press the **Manual operation** key



- ▶ Press the **TOOL TABLE** soft key

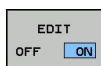

- ▶ Press the **EDIT** soft key



- ▶ Move the cursor to the **KINEMATIC** column



- ▶ Press the **SELECT** soft key

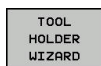

- ▶ Press the **TOOL HOLDER WIZARD** soft key
- > The control opens the additional **ToolHolderWizard** tool in a pop-up window.



- ▶ Press the **OPEN FILE** icon
- > The control opens a pop-up window.
- ▶ Select the desired tool carrier template using the preview screen
- ▶ Press the **OK** button
- > The control opens the selected tool carrier template.
- > The cursor goes to the first parameterizable value.
- ▶ Adjust values
- ▶ Enter the name for the parameterized tool holder in the **Output file** area
- ▶ Press the **GENERATE FILE** button
- ▶ If required, reply to the message on the control
- ▶ Press the **CLOSE** icon
- > The control closes the additional tool



### Parameterizing the tool carrier template in the Programming operating mode

Proceed as follows to parameterize tool carrier templates and save these parameters:



- ▶ Press the **Programming** key



- ▶ Press the **PGM MGT** key
- ▶ Select the path **TNC:\system\Toolkinematics**
- ▶ Select the tool carrier template
- > The control opens the additional **ToolHolderWizard** tool with the selected tool carrier template.
- > The cursor goes to the first parameterizable value.
- ▶ Adjust values
- ▶ Enter the name for the parameterized tool holder in the **Output file** area
- ▶ Press the **GENERATE FILE** button
- ▶ If required, reply to the message on the control
- ▶ Press the **CLOSE** icon
- > The control closes the additional tool





## Allocating parameterized tool carriers

To allow the control to factor a parameterized tool carrier into calculations, you must allocate the tool carrier to a tool and **call the tool again**.



Parameterized tool carriers can consist of several sub-files. If the sub-files are incomplete, the control will display an error message.

**Only use fully parameterized tool carriers!**

Proceed as follows to allocate a parameterized tool carrier to a tool:



- ▶ Operating mode: Press the **Manual operation** key



- ▶ Press the **TOOL TABLE** soft key

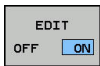

- ▶ Press the **EDIT** soft key



- ▶ Move the cursor to the **KINEMATIC** column of the required tool



- ▶ Press the **SELECT** soft key
- ▶ The control opens a pop-up window with parameterized tool carriers
- ▶ Select the desired tool carrier using the preview screen
- ▶ Press the **OK** soft key
- ▶ The control copies the name of the selected tool carrier to the **KINEMATIC** column



- ▶ Exit the tool table

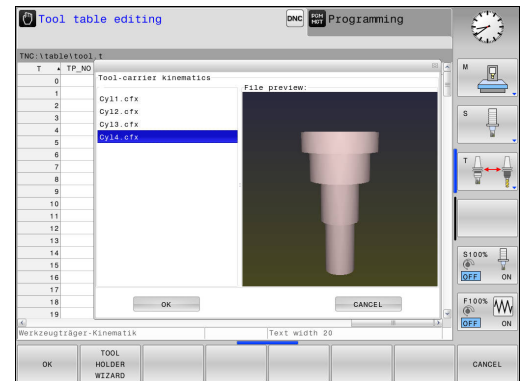

## 12.3 Active Chatter Control ACC (option 145)

### Application



This feature must be enabled and adapted by the machine tool builder.

Strong forces come into play during roughing (power milling). Depending on the tool spindle speed, the resonances in the machine tool and the chip volume (metal-removal rate during milling), the machine can sometimes begin to **chatter**. This chattering places heavy strain on the machine, and causes ugly marks on the workpiece surface. The tool, too, is subject to heavy and irregular wear from chattering. In extreme cases it can result in tool breakage.

To reduce the inclination to chattering, HEIDENHAIN now offers an effective antidote with **ACC (Active Chatter Control)**. The use of this control function is particularly advantageous during heavy cutting. ACC makes substantially higher metal removal rates possible. This enables you to increase your metal removal rate by up to 25 % and more, depending on the type of machine. You reduce the mechanical load on the machine and increase the life of your tools at the same time.



ACC was developed especially for heavy cutting and is particularly effective in this area. You need to conduct appropriate tests to ensure whether ACC is also advantageous during standard roughing.

When you use the ACC feature, you must enter the number of tool cuts **CUT** for the corresponding tool in the TOOL.T tool table.

## Activating/deactivating ACC

To activate ACC, you first need to set the **ACC** column to **Y** (**ENT** key = Y, **NO ENT** = N) for the respective tool in the tool table TOOL.T.

Activate/deactivate ACC for the machine mode:



- ▶ Operating mode: Press the **Program run, full sequence, Program run, single block** or **Positioning w/ Manual Data Input** key



- ▶ Shift the soft-key row

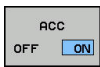

- ▶ Activate ACC: Set the soft key to **ON**
- > The control displays the ACC icon in the position display.  
**Further information:** "Status displays", page 94



- ▶ To deactivate ACC: Set the soft key to **OFF**

If ACC is active, the control shows the **ACC** icon in the position display.

## 12.4 Working with the parallel axes U, V and W

### Overview



Refer to your machine manual.  
 Your machine must be configured by the machine manufacturer if you want to use parallel-axis functions.  
 Depending on the configuration, the **PARAXCOMP** function may be activated by default.

The axes U, V and W are secondary axes parallel to the principal axes X, Y and Z, respectively. Principal axes and parallel axes are permanently assigned to each other.

Principal axis	Parallel axis	Rotary axis
X	U	A
Y	V	B
Z	W	C

The control provides the following functions for machining with the parallel axes U, V and W:

Soft key	Function	Meaning	Page
FUNCTION PARAXCOMP	<b>PARAXCOMP</b>	Define the control's behavior when positioning parallel axes	503
FUNCTION PARAXMODE	<b>PARAXMODE</b>	Define the axes the control is to use for machining	504



After the control has been started up, the standard configuration is effective by default.  
 You must deactivate the parallel-axis functions before switching the machine kinematics.  
 You can deactivate the programming of parallel axes with the machine parameter **noParaxMode** (no. 105413).

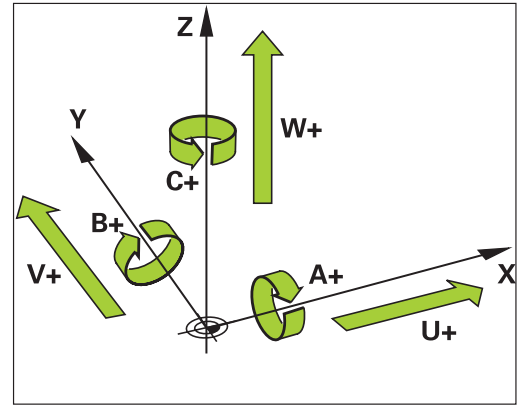





## FUNCTION PARAXCOMP DISPLAY

### Example

#### 13 FUNCTION PARAXCOMP DISPLAY W

Use the **PARAXCOMP DISPLAY** function to activate the display function for parallel axis movements. The control includes movements of the parallel axis in the position display of the associated principal axis (sum display). Therefore, the position display of the principal axis always displays the relative distance from the tool to the workpiece, regardless of whether you move the principal axis or the minor axis.

Proceed as follows for the definition:

-  ▶ Show the soft-key row with special functions
-  ▶ Press the **PROGRAM FUNCTIONS** soft key
-  ▶ Select **FUNCTION PARAX**
-  ▶ Select **FUNCTION PARAXCOMP**
-  ▶ Select the **FUNCTION PARAXCOMP DISPLAY** function
- ▶ Define the parallel axis whose movements the control is to take into account in the position display of the associated principal axis

## FUNCTION PARAXCOMP MOVE

### Example

#### 13 FUNCTION PARAXCOMP MOVE W



The **PARAXCOMP MOVE** function can be used only in conjunction with straight-line blocks (**L**)

The control uses the **PARAXCOMP MOVE** function to compensate for the movement of a parallel axis by performing a compensation movement in the associated principal axis.

For example, if a parallel-axis movement is performed in the negative W-axis direction, the principal axis Z is moved simultaneously in the positive direction by the same value. The relative distance from the tool to the workpiece remains the same. Application in gantry-type milling machines: Retract the spindle sleeve to move the cross beam down simultaneously.

Proceed as follows for the definition:

SPEC  
FCT

- ▶ Show the soft-key row with special functions

PROGRAM  
FUNCTIONS

- ▶ Press the **PROGRAM FUNCTIONS** soft key

FUNCTION  
PARAX

- ▶ Select **FUNCTION PARAX**

FUNCTION  
PARAXCOMP

- ▶ Select **FUNCTION PARAXCOMP**

FUNCTION  
PARAXCOMP  
MOVE

- ▶ Select the **FUNCTION PARAXCOMP MOVE** function
- ▶ Define the parallel axis



Possible offset values (U\_OFFS, V\_OFFS and W\_OFFS from the preset table) to be taken into account will be specified by your machine tool builder in the **presetToAlignAxis** machine parameter (no. 300203).



Your machine tool builder can also activate the **PARAXCOMP** functions permanently using a machine parameter.

## Deactivating FUNCTION PARAXCOMP



After the control has been started up, the standard configuration is effective by default.

The **PARAXCOMP** parallel-axis function is automatically reset by the control with the following functions:

- Selection of a program
- **PARAXCOMP OFF**

You must deactivate the parallel-axis functions before switching the machine kinematics.

### Example

```
13 FUNCTION PARAXCOMP OFF
```

```
13 FUNCTION PARAXCOMP OFF W
```

Use the **PARAXCOMP OFF** function to switch off the **PARAXCOMP DISPLAY** and **PARAXCOMP MOVE** parallel-axis functions. Proceed as follows for the definition:

SPEC  
FCT

- ▶ Show the soft-key row with special functions

PROGRAM  
FUNCTIONS

- ▶ Press the **PROGRAM FUNCTIONS** soft key

FUNCTION  
PARAX

- ▶ Select **FUNCTION PARAX**

FUNCTION  
PARAXCOMP

- ▶ Select **FUNCTION PARAXCOMP**

FUNCTION  
PARAXCOMP  
OFF

- ▶ Select **FUNCTION PARAXCOMP OFF**. If you want to switch off the parallel-axis functions only for individual parallel axes, then the respective axis must be specifically indicated.

## FUNCTION PARAXMODE

### Example

```
13 FUNCTION PARAXMODE X Y W
```







To activate the **PARAXMODE** function, you must always define three axes.

If you combine the **PARAXMODE** and **PARAXCOMP** functions, the control will deactivate the **PARAXCOMP** function for an axis that was defined in both functions. Once you deactivate **PARAXMODE**, the **PARAXCOMP** function becomes active again.

Use the **PARAXMODE** function to define the axes the control is to use for machining. You program all traverse movements and contour descriptions in the principal axes X, Y and Z, independent of your machine.

Define 3 axes in the **PARAXMODE** function (e.g. **FUNCTION PARAXMODE X Y W**) to be used by the control for programmed traverse movements.

Proceed as follows for the definition:

-  ▶ Show the soft-key row with special functions
-  ▶ Press the **PROGRAM FUNCTIONS** soft key
-  ▶ Select **FUNCTION PARAX**
-  ▶ Select **FUNCTION PARAXMODE**
-  ▶ Select **FUNCTION PARAXMODE**  
▶ Define the axes for machining

### Move the principal axis and the parallel axis simultaneously

#### Example

```
13 FUNCTION PARAXMODE X Y W
```

```
14 L Z+100 &Z+150 R0 FMAX
```

If the **PARAXMODE** function is active, the control uses the axes defined in the function to execute the programmed traverse movements. If the control is to move a parallel axis simultaneously with the associated principal axis, you can identify the respective axis by additionally entering the **&** character. The axis with the **&** character then refers to the principal axis.





The **&** syntax element is only permitted in L blocks.

Additional positioning of a principal axis with the **&** command is done in the REF system. If you have set the position display to display ACTUAL values, this movement will not be shown. If necessary, switch the position display to REF values.

Your machine tool builder will define the calculation of possible offset values (X\_OFFS, Y\_OFFS and Z\_OFFS from the preset table) for the axes positioned with the **&** operator in the **presetToAlignAxis** machine parameter (no. 300203).

## Deactivating FUNCTION PARAXMODE



After the control has been started up, the standard configuration is effective by default.

The control automatically resets the **PARAXMODE OFF** parallel-axis function via the following functions:

- Selection of program
- End of program
- **M2** and **M30**
- **PARAXMODE OFF**

You must deactivate the parallel-axis functions before switching the machine kinematics.

### Example

#### 13 FUNCTION PARAXMODE OFF

Use the **PARAXCOMP OFF** function to switch off the parallel-axis function. The control then uses the principal axes defined by the machine manufacturer. Proceed as follows for the definition:

SPEC  
FCT

- ▶ Show the soft-key row with special functions

PROGRAM  
FUNCTIONS

- ▶ Press the **PROGRAM FUNCTIONS** soft key

FUNCTION  
PARAX

- ▶ Select **FUNCTION PARAX**

FUNCTION  
PARAXMODE

- ▶ Select **FUNCTION PARAXMODE**

FUNCTION  
PARAXMODE  
OFF

- ▶ Select **FUNCTION PARAXMODE OFF**

**Example: Drilling with the W axis**

0 BEGIN PGM PAR MM	
1 BLK FORM 0.1 Z X+0 Y+0 Z-20	
2 BLK FORM 0.2 X+100 Y+100 Z+0	
3 TOOL CALL 5 Z S2222	Call the tool in the spindle axis Z
4 L Z+0 W+0 R0 FMAX M91	Reset the principal axis and minor axis
5 L Z+100 R0 FMAX M3	Position the principal axis
6 CYCL DEF 200 DRILLING	
Q200=+2           ;SET-UP CLEARANCE	
Q201=-20         ;DEPTH	
Q206=+150       ;FEED RATE FOR PLNGNG	
Q202=+5          ;PLUNGING DEPTH	
Q210=+0          ;DWELL TIME AT TOP	
Q203=+0          ;SURFACE COORDINATE	
Q204=+50         ;2ND SET-UP CLEARANCE	
Q211=+0          ;DWELL TIME AT DEPTH	
Q395=+0          ;DEPTH REFERENCE	
7 FUNCTION PARAXCOMP DISPLAY Z W	Activate display compensation
8 FUNCTION PARAXMODE X Y W	Positive axis selection
9 L X+50 Y+50 R0 FMAX M99	Infeed runs minor axis W
10 FUNCTION PARAXMODE OFF	Restore standard axis configuration
11 L Z+0 W+0 R0 FMAX M91	Reset the principal axis and minor axis
12 L M30	
13 END PGM PAR MM	

## 12.5 File functions

### Application

The **FILE FUNCTION** functions are used to perform file operations such as copying, moving, and deleting files from within the NC program.



You must not use **FILE** functions on programs or files, to which you have previously made reference with functions such as **CALL PGM** or **CYCL DEF 12 PGM CALL**.

### Defining file functions

SPEC  
FCT

- ▶ Press the special functions key

PROGRAM  
FUNCTIONS

- ▶ Select the program functions

FUNCTION  
FILE

- ▶ Select file operations
- > The control displays the available functions.

Soft key	Function	Meaning
FILE COPY	<b>FILE COPY</b>	Copy file: Enter the name and path of the file to be copied, as well as the target path
FILE MOVE	<b>FILE MOVE</b>	Move file: Enter the name and path of the file to be moved, as well as the target path
FILE DELETE	<b>FILE DELETE</b>	Delete file: Enter the path and name of the file to be deleted

If you try to copy a file that does not exist, the control generates an error message.

**FILE DELETE** does not generate an error message if you try to delete a non-existing file.

## 12.6 Defining coordinate transformations

### Overview

As an alternative to the coordinate transformation Cycle 7, **DATUM SHIFT**, you can also use the **TRANS DATUM** conversational function. Just as in Cycle 7, you can use **TRANS DATUM** to directly program shift values or activate a line from a selectable datum table. In addition, there is also the **TRANS DATUM RESET** function that can be used to easily reset a datum shift.



In the optional machine parameter **CfgDisplayCoordSys** (no. 127501) you can specify the coordinate system in which the status display shows an active datum shift.

### TRANS DATUM AXIS

#### Example

```
13 TRANS DATUM AXIS X+10 Y+25 Z+42
```

You can define a datum shift by entering values in the respective axis with the **TRANS DATUM AXIS** function. You can define up to nine coordinates in one block, and incremental entries are possible. Proceed as follows for the definition:

SPEC  
FCT

- ▶ Show the soft-key row with special functions

PROGRAM  
FUNCTIONS

- ▶ Press the **PROGRAM FUNCTIONS** soft key

TRANSFORM

- ▶ Select transformations

TRANS  
DATUM

- ▶ Select the **TRANS DATUM** datum shift

VALUES  
X Y Z

- ▶ Select the value input soft key
- ▶ Enter the datum shift in the affected axes, confirming with the **ENT** key each time







Values entered as absolute numbers refer to the workpiece preset, which is specified either by presetting or by selecting a preset from the preset table. Incremental values always refer to the datum which was last valid (this may be a datum which has already been shifted).

## TRANS DATUM TABLE

### Example

#### 13 TRANS DATUM TABLE TABLINE25

You can define a datum shift by selecting a datum number from a datum table with the **TRANS DATUM TABLE** function. Proceed as follows for the definition:

- 
  - ▶ Show the soft-key row with special functions
- 
  - ▶ Press the **PROGRAM FUNCTIONS** soft key
- 
  - ▶ Select transformations
- 
  - ▶ Select the **TRANS DATUM** datum shift
- 
  - ▶ Select the **TRANS DATUM TABLE** datum shift
  - ▶ Enter the line number to be activated by the control, confirm with the **ENT** key
  - ▶ If desired, enter the name of the datum table from which you want to activate the datum number, and confirm with the **ENT** key. If you do not want to define a datum table, confirm with the **NO ENT** key







If you have not defined a datum table in the **TRANS DATUM TABLE** block, then the control uses the datum table previously selected with **SEL TABLE** or the datum table activated in the **Program run, single block** or **Program run, full sequence** operating mode (status **M**).

## TRANS DATUM RESET

### Example

#### 13 TRANS DATUM RESET

Use the **TRANS DATUM RESET** function to cancel a datum shift. How you previously defined the datum is irrelevant. Proceed as follows for the definition:

-  ▶ Show the soft-key row with special functions
-  ▶ Press the **PROGRAM FUNCTIONS** soft key
-  ▶ Select transformations
-  ▶ Select the **TRANS DATUM** datum shift
-  ▶ Press the **RESET DATUM SHIFT** soft key

## 12.7 Defining a counter

### Application



Refer to your machine manual.  
Your machine manufacturer enables this function.

The FUNCTION COUNT function allows you to control a simple counter from within the NC program. For example, this function allows you to count the number of manufactured workpieces. The counter is only effective in the **Program Run Single Block** and **Program Run Full Sequence** operating modes.

The counter values are retained even after a restart of the control. You can use Cycle 225 to engrave the current counter value into the workpiece.

Proceed as follows for the definition:

SPEC  
FCT

- ▶ Show the soft key row with special functions

PROGRAM  
FUNCTIONS

- ▶ Press the **PROGRAM FUNCTIONS** soft key

FUNCTION  
COUNT

- ▶ Press the **FUNCTION COUNT** soft key

### NOTICE

#### Caution: Data may be lost!

Only one counter can be managed by the control. If you execute an NC program that resets the counter, any counter progress of another NC program will be deleted.

- ▶ Please check prior to machining whether a counter is active.
- ▶ If necessary, note down the counter value and enter it again via the MOD menu after execution.



You can use Cycle 225 to engrave the current counter value into the workpiece.

**Further information:** Cycle Programming User's Manual



## Define FUNCTION COUNT

The **FUNCTION COUNT** function provides the following possibilities:

Soft key	Meaning
FUNCTION COUNT INC	Increase count by 1
FUNCTION COUNT RESET	Reset counter
FUNCTION COUNT TARGET	Set the nominal count (target value) to the desired value Input value: 0–9999
FUNCTION COUNT SET	Set the counter to the desired value Input value: 0–9999
FUNCTION COUNT ADD	Increment the counter by the desired value Input value: 0–9999
FUNCTION COUNT REPEAT	Repeat the NC program starting from this label if more parts are to be machined.

### Example

5 FUNCTION COUNT RESET	Reset the counter value
6 FUNCTION COUNT TARGET10	Enter the target number of parts to be machined
7 LBL 11	Enter the jump label
8 L ...	Machining
51 FUNCTION COUNT INC	Increment the counter value
52 FUNCTION COUNT REPEAT LBL 11	Repeat the machining operations if more parts are to be machined.
53 M30	
54 END PGM	

## 12.8 Creating text files

### Application

You can use the control's text editor to write and edit texts. Typical applications:







- Recording test results
- Documenting working procedures
- Creating formula collections

Text files have the extension .A (for ASCII files). If you want to edit other types of files, you must first convert them into type .A files.

### Opening and exiting a text file

- ▶ Operating mode: Press the **Programming** key
- ▶ To call the file manager, press the **PGM MGT** key.
- ▶ Display type .A files: Press the **SELECT TYPE** soft key and **SHOW ALL** soft key one after the other
- ▶ Select a file and open it with the **SELECT** soft key or **ENT** key, or create a new file by entering the new file name and confirming your entry with the **ENT** key

To leave the text editor, call the file manager and select a file of a different file type, for example a part program.

Soft key	Cursor movements
	Move cursor one word to the right
	Move cursor one word to the left
	Go to next screen page
	Go to previous screen page
	Cursor at beginning of file
	Cursor at end of file

## Editing texts

Above the first line of the text editor, there is an information field showing the file name, location and line information:

- File:** Name of the text file  
**Line:** Line in which the cursor is presently located  
**Column:** Column in which the cursor is presently located

The text is inserted or overwritten at the location of the cursor. You can move the cursor to any desired position in the text file by pressing the arrow keys.

You can insert a line break with the **RETURN** or **ENT** key.

## Deleting and re-inserting characters, words and lines

With the text editor, you can erase words and even lines, and insert them at any desired location in the text.

- ▶ Move the cursor to the word or line that you wish to erase and insert at a different place in the text
- ▶ Press the **DELETE WORD** or **DELETE LINE** soft key: The text is deleted and stored temporarily.
- ▶ Move the cursor to the location where you wish insert the text, and press the **INSERT LINE / WORD** soft key.

Soft key	Function
DELETE LINE	Delete and temporarily store a line
DELETE WORD	Delete and temporarily store a word
DELETE CHAR	Delete and temporarily store a character
INSERT LINE / WORD	Insert a line or word from temporary storage

## Editing text blocks

You can copy and erase text blocks of any size, and insert them at other locations. Before any of these actions, you must first select the desired text block:

- ▶ To select a text block: Move the cursor to the first character of the text you wish to select.

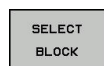

- ▶ Press the **SELECT BLOCK** soft key.
- ▶ Move the cursor to the last character of the text you wish to select. You can select whole lines by moving the cursor up or down directly with the arrow keys—the selected text is shown in a different color.

After selecting the desired text block, you can edit the text with the following soft keys:

Soft key	Function
	Delete the selected block and store temporarily
	Store the selected block temporarily without erasing (copy)

If desired, you can now insert the temporarily stored block at a different location:

- ▶ Move the cursor to the location where you want to insert the temporarily stored text block

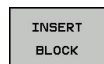

- ▶ Press the **INSERT BLOCK** soft key—the text block is inserted.

You can insert the temporarily stored text block as often as desired

### Transferring the selected block to a different file

- ▶ Select the text block as described previously

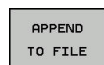

- ▶ Press the **APPEND TO FILE** soft key.
- ▶ The control displays the **Destination file =** dialog message.
- ▶ Enter the path and the name of the destination file.
- ▶ The control appends the selected text block to the specified file. If no target file with the specified name is found, the control creates a new file with the selected text.

### Inserting another file at the cursor position

- ▶ Move the cursor to the location in the text where you wish to insert another file

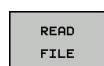

- ▶ Press the **READ FILE** soft key.
- ▶ The control displays the **File name =** dialog message.
- ▶ Enter the path and name of the file you want to insert

## Finding text sections

With the text editor, you can search for words or character strings in a text. The control provides the following two options.

### Finding the current text

The search function is used for finding the next occurrence of the word in which the cursor is presently located:

- ▶ Move the cursor to the desired word.
- ▶ To select the search function, press the **FIND** soft key.
- ▶ Press the **FIND CURRENT WORD** soft key.
- ▶ To find a word: press the **FIND** soft key.
- ▶ Exit the search function: Press the **END** soft key

### Finding any text

- ▶ To select the search function, press the **FIND** soft key. The control shows the **Find text :** dialog prompt
- ▶ Enter the text that you wish to find
- ▶ To find text: press the **FIND** soft key.
- ▶ Exit the search function: Press the **END** soft key

## 12.9 Freely definable tables

### Fundamentals

In freely definable tables you can save and read any information from the NC program. The Q parameter functions **FN 26** to **FN 28** are provided for this purpose.

You can change the format of freely definable tables, i.e. the columns and their properties, by using the structure editor. They enable you to make tables that are exactly tailored to your application.

You can also toggle between a table view (standard setting) and form view.

NR	X	Y	Z	A	C	DOC
0	100.001	49.999	0			PAT 1
1	99.994	49.999	0			PAT 2
2	99.989	50.001	0			PAT 3
3	100.002	49.995	0			PAT 4
4	99.990	50.003	0			PAT 5
5						
6						
7						
8						
9						
10						



The names of tables and table columns must start with a letter and must not contain an arithmetic operator (e.g., +). Due to SQL commands, these characters can cause problems when inputting data or reading it out.

### Creating a freely definable table

- ▶ To call the file manager, press the **PGM MGT** key
- ▶ Enter any desired file name with the .TAB extension and confirm it with the **ENT** key
- ▶ The control displays a pop-up window with permanently stored table formats
- ▶ Use the arrow key to select the desired table template, e.g. **example.tab** and confirm it with the **ENT** key
- ▶ The control opens a new table in the predefined format
- ▶ To adapt the table to your requirements you have to edit the table format

**Further information:** "Editing the table format", page 519



Refer to your machine manual. Machine tool builders may define their own table templates and save them in the control. When you create a new table, the control opens a pop-up window listing all available table templates.



You can also save your own table templates in the control. To do so, create a new table, change the table format and save the table in the **TNC:\system\proto** directory. Then your template will also be available in the list box for table templates when you create a new table.

### Editing the table format

- ▶ Press the **EDIT FORMAT** soft key (toggle the soft key row)
- > The control opens the editor form displaying the table structure. The meanings of the structure commands (header entries) are shown in the following table.

Structure command	Meaning
<b>Available columns:</b>	List of all columns contained in the table
<b>Move before:</b>	The entry highlighted in <b>Available columns</b> is moved in front of this column
<b>Name</b>	Column name: Is displayed in the header
<b>Column type</b>	<b>TEXT:</b> Text entry <b>SIGN:</b> + or - sign <b>BIN:</b> Binary number <b>DEC:</b> Decimal, positive, whole number (cardinal number) <b>HEX:</b> Hexadecimal number <b>INT:</b> Whole number <b>LENGTH:</b> Length (is converted in inch programs) <b>FEED:</b> Feed rate (mm/min or 0.1 inch/min) <b>IFEED:</b> Feed rate (mm/min or inch/min) <b>FLOAT:</b> Floating-point number <b>BOOL:</b> Logical value <b>INDEX:</b> Index <b>TSTAMP:</b> Fixed format for date and time <b>UPTTEXT:</b> Text entry in upper case <b>PATHNAME:</b> Path name
<b>Default value</b>	Default value for the fields in this column
<b>Width</b>	Width of the column (number of characters)
<b>Primary key</b>	First table column
<b>Language-sensitive column name</b>	Language-sensitive dialogs

Use a connected mouse or the control's keyboard to navigate in the form. Navigation using the control's keyboard:



- ▶ Press the navigation keys to go to the entry fields. Use the arrow keys to navigate within an entry field. To open pop-down menus, press the **GOTO** key.

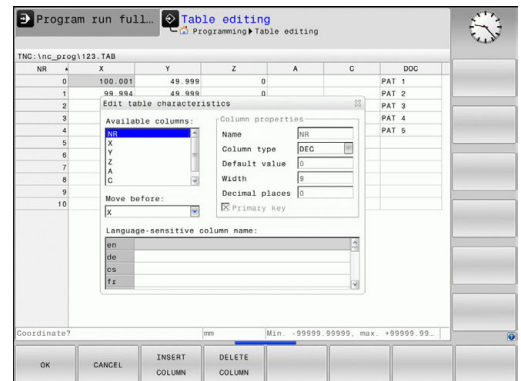



In a table that already contains lines you can not change the table properties **Name** and **Column type**. Once you have deleted all lines, you can change these properties. If required, create a backup copy of the table beforehand.

With the **CE** and **ENT** key combination, you can reset invalid values in fields with the **TSTAMP** column type.

### Exiting the structure editor

- ▶ Press the **OK** soft key
- ▶ The control closes the editor form and applies the changes. All changes are discarded by pressing the **CANCEL** soft key.

### Switching between table and form view

All tables with the **.TAB** extension can be opened in either list view or form view.



- ▶ Press the key for setting the screen layout. Select the respective soft key for list view or form view (form view: with or without dialog texts)

In the left half of the form view, the control lists the line numbers with the contents of the first column.

In the right half you can change the data.

- ▶ Press the **ENT** key or the arrow key to move to the next entry field
- ▶ To select another line press the navigation key (folder symbol). This moves the cursor to the left window, and you can select the desired line with the arrow keys. Press the green navigation key to switch back to the input window.





**FN 26: TABOPEN – Open a freely definable table**

With the function **FN 26: TABOPEN** you open a freely definable table to be written to with **FN 27** or to be read from with **FN 28**.



Only one table can be opened in an NC program at any one time. A new block with **FN 26: TABOPEN** automatically closes the last opened table.  
The table to be opened must have the extension **.TAB**.

**Example: Open the table TAB1.TAB, which is saved in the directory TNC:\DIR1.**

```
56 FN 26: TABOPEN TNC:\DIR1\TAB1.TAB
```

## FN 27: TABWRITE – Write to a freely definable table

With the **FN 27: TABWRITE** function you write to the table that you previously opened with **FN 26: TABOPEN**.

You can define multiple column names in a **TABWRITE** block. The column names must be written between quotation marks and separated by a comma. You define in Q parameters the value that the control is to write to the respective column.



The **FN 27: TABWRITE** function by default writes values to the currently open table, even in the **Test Run** operating mode. The **FN 18 ID992 NR16** function allows you to retrieve the operating mode in which the program is running. If the **FN27** function is to be run only in the **Program run, single block** and **Program run, full sequence** operating modes, you can skip the respective program section by using a jump statement.

**Further information:** "If-then decisions with Q parameters", page 376

You can write only to numerical table fields.

If you wish to write to more than one column in a block, you must save the values under successive Q parameter numbers.

### Example

You wish to write to the columns "Radius," "Depth" and "D" in line 5 of the presently opened table. The value to be written in the table must be saved in the Q parameters Q5, Q6 and Q7.

```
53 Q5 = 3.75
```

```
54 Q6 = -5
```

```
55 Q7 = 7.5
```

```
56 FN 27: TABWRITE 5/"RADIUS,DEPTH,D" = Q5
```

## FN 28: TABREAD – Read from a freely definable table

With the **FN 28: TABREAD** function you read from the table previously opened with **FN 26: TABOPEN**.

You can define, i.e. read, multiple column names in a **TABREAD** block. The column names must be written between quotation marks and separated by a comma. In the **FN 28** block you can define the Q parameter number in which the control is to write the value that is first read.



You can read only numerical table fields.  
If you wish to read from more than one column in a block, the control will save the values under successive Q parameter numbers.

### Example

You wish to read the values of the columns "Radius," "Depth" and "D" from line 6 of the presently opened table. Save the first value in Q parameter Q10 (second value in Q11, third value in Q12).

```
56 FN 28: TABREAD Q10 = 6/"RADIUS,DEPTH,D"
```

## Customizing the table format

### NOTICE

#### Caution: Data may be lost!

The **ADAPT NC PGM / TABLE** function changes the format of all tables permanently. Existing data is not automatically backed up by the control before running the format change process, i.e. the files are changed permanently and might no longer be usable.

- ▶ Only use the function in consultation with the machine tool builder.

Soft key	Function
ADAPT NC PGM / TABLE	Adapt format of tables present after changing the control software version
	The names of tables and table columns must start with a letter and must not contain an arithmetic operator (e.g., +). Due to SQL commands, these characters can cause problems when inputting data or reading it out.



The names of tables and table columns must start with a letter and must not contain an arithmetic operator (e.g., +). Due to SQL commands, these characters can cause problems when inputting data or reading it out.

## 12.10 Pulsing spindle speed FUNCTION S-PULSE

### Programming a pulsing spindle speed

#### Application



Refer to your machine manual.  
Read and note the functional description of the machine tool builder.  
Follow the safety precautions.

Using the **S-PULSE FUNCTION** you can program a pulsing spindle speed, when operating at a constant spindle speed.

You can define the duration of a vibration (period length) using the P-TIME input value or a speed change in percent using the SCALE input value. The spindle speed changes in a sinusoidal form around the target value.

#### Procedure

#### Example

#### 13 FUNCTION S-PULSE P-TIME10 SCALE5

Proceed as follows for the definition:

SPEC  
FCT

- ▶ Show the soft-key row with special functions

PROGRAM  
FUNCTIONS

- ▶ Press the **PROGRAM FUNCTIONS** soft key

FUNCTION  
SPINDLE

- ▶ Press the **FUNCTION SPINDLE** soft key

SPINDLE-  
PULSE

- ▶ Press the **SPINDLE-PULSE** soft key
- ▶ Define period length P-TIME
- ▶ Define speed change SCALE



The control never exceeds a programmed speed limit. The spindle speed is maintained until the sinusoidal curve of the **S-PULSE FUNCTION** falls below the maximum speed once more.

#### Symbols

In the status bar the symbol indicates the condition of the pulsing shaft speed:

Icon	Function
	Pulsing spindle speed active

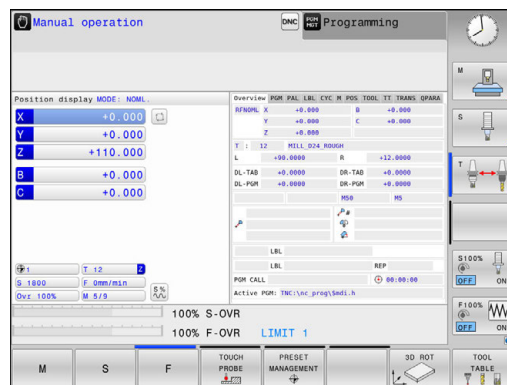





## Resetting the pulsing spindle speed

### Example

#### 18 FUNCTION S-PULSE RESET

Use the **FUNCTION S-PULSE RESET** to reset the pulsing spindle speed.

Proceed as follows for the definition:

-  ▶ Show the soft-key row with special functions
-  ▶ Press the **PROGRAM FUNCTIONS** soft key
-  ▶ Press the **FUNCTION SPINDLE** soft key
-  ▶ Press the **RESET SPINDLE-PULSE** soft key.

## 12.11 Dwell time FUNCTION FEED

### Programming dwell time

#### Application



Refer to your machine manual.  
Read and note the functional description of the machine tool builder.  
Follow the safety precautions.

The **FUNCTION FEED DWELL** function can be used to program a recurring dwell time in seconds, e.g. to force chip breaking . Program **FUNCTION FEED DWELL** immediately prior to the machining you wish to run with chip breaking.

The **FUNCTION FEED DWELL** function is not effective with rapid traverse movements and probing motion.

### NOTICE

#### Caution: Danger to the tool and workpiece!

When the **FUNCTION FEED DWELL** function is active, the control will repeatedly interrupt the feed movement. While the feed movement is interrupted, the tool remains at its current position while the spindle continues to turn. Due to this behavior, workpieces need to be scrapped if threads are cut. In addition, there is a danger of tool breakage during execution!

- ▶ Deactivate the **FUNCTION FEED DWELL** function before cutting threads

#### Procedure

#### Example

**13 FUNCTION FEED DWELL D-TIME0.5 F-TIME5**

Proceed as follows for the definition:

SPEC  
FCT

- ▶ Show the soft-key row with special functions

PROGRAM  
FUNCTIONS

- ▶ Press the **PROGRAM FUNCTIONS** soft key

FUNCTION  
FEED

- ▶ Press the **FUNCTION FEED** soft key

FEED  
DWELL

- ▶ Press the **FEED DWELL** soft key
- ▶ Define the interval duration for dwelling D-TIME
- ▶ Define the interval duration for cutting F-TIME

## Resetting dwell time



Reset to the dwell time immediately following the machining with chip breaking.

### Example

#### 18 FUNCTION FEED DWELL RESET

Use **FUNCTION FEED DWELL RESET** to reset the recurring dwell time.

Proceed as follows for the definition:

SPEC  
FCT

- ▶ Show the soft-key row with special functions

PROGRAM  
FUNCTIONS

- ▶ Press the **PROGRAM FUNCTIONS** soft key

FUNCTION  
FEED

- ▶ Press the **FUNCTION FEED** soft key

RESET  
FEED  
DWELL

- ▶ Press the **RESET FEED DWELL** soft key



You can also reset the dwell time by entering D-TIME 0. The control automatically resets the **FUNCTION FEED DWELL** function at the end of a program.

## 12.12 Dwell time FUNCTION DWELL

### Programming dwell time

#### Application

The **FUNCTION DWELL** function enables you to program a dwell time in seconds or define the number of spindle revolutions for dwelling.

#### Procedure





#### Example

13 FUNCTION DWELL TIME10

#### Example

23 FUNCTION DWELL REV5.8

Proceed as follows for the definition:

- ▶  Show the soft-key row with special functions
- ▶  Press the **PROGRAM FUNCTIONS** soft key
- ▶  **FUNCTION DWELL** soft key
- ▶  Press the **DWELL TIME** soft key
- ▶ Define the duration in seconds
- ▶  Alternatively, press the **DWELL REVOLUTIONS** soft key
- ▶ Define the number of spindle revolutions



## 12.13 Lift off tool at NC stop: FUNCTION LIFTOFF

### Programming tool lift-off with FUNCTION LIFTOFF

#### Requirement



Refer to your machine manual.

This function must be configured and enabled by your machine tool builder. In the **CfgLiftOff** (no. 201400) machine parameter, the machine tool builder defines the path the control is to traverse for a **LIFTOFF** command. You can also use the **CfgLiftOff** machine parameter to deactivate the function.

In the **LIFTOFF** column of the tool table, set the **Y** parameter for the active tool.

**Further information:** "Entering tool data into the table", page 234

#### Application

The **LIFTOFF** function is effective in the following situations:

- In case of an NC stop triggered by you
- In case of an NC stop triggered by the software, e. g. if an error has occurred in the drive system.
- In case of a power failure

The tool retracts from the contour by up to 2 mm. The control calculates the lift off direction based on the input in the **FUNCTION LIFTOFF** block.

You can program the **LIFTOFF** function in the following ways:

- **FUNCTION LIFTOFF TCS X Y Z:** Lift-off with a defined vector in the tool coordinate system
- **FUNCTION LIFTOFF ANGLE TCS SPB:** Lift-off with a defined angle in the tool coordinate system
- Lift-off in the tool axis direction with **M148**

**Further information:** "Automatically retracting the tool from the contour at an NC stop: M148", page 487





## Programming tool lift-off with a defined vector

### Example

**18 FUNCTION LIFTOFF TCS X+0 Y+0.5 Z+0.5**

With **LIFTOFF TCS X Y Z**, you define the lift-off direction as a vector in the tool coordinate system. The control calculates the lift-off height in each axis based on the tool path defined by the machine tool builder.

Proceed as follows for the definition:

-  ▶ Show the soft-key row with special functions
-  ▶ Press the **PROGRAM FUNCTIONS** soft key
-  ▶ Press the **FUNCTION LIFTOFF** soft key
-  ▶ Press the **LIFTOFF TCS** soft key
- ▶ Enter X, Y, and Z vector components

## Programming tool lift-off with a defined angle





### Example

**18 FUNCTION LIFTOFF ANGLE TCS SPB+20**

With **LIFTOFF ANGLE TCS SPB**, you define the lift-off direction as a spatial angle in the tool coordinate system.

The SPB angle you enter describes the angle between Z and X. If you enter 0°, the tool lifts off in the tool Z axis direction.

Proceed as follows for the definition:

-  ▶ Show the soft-key row with special functions
-  ▶ Press the **PROGRAM FUNCTIONS** soft key
-  ▶ Press the **FUNCTION LIFTOFF** soft key
-  ▶ Press the **LIFTOFF ANGLE TCS** soft key
- ▶ Enter the SPB angle

## Resetting the lift-off function

### Example

#### 18 FUNCTION LIFTOFF RESET

Use the **FUNCTION LIFTOFF RESET** to reset the lift-off function.  
Proceed as follows for the definition:

SPEC  
FCT

- ▶ Show the soft-key row with special functions

PROGRAM  
FUNCTIONS

- ▶ Press the **PROGRAM FUNCTIONS** soft key

FUNCTION  
LIFTOFF

- ▶ Press the **FUNCTION LIFTOFF** soft key

LIFTOFF  
RESET

- ▶ Press the **LIFTOFF RESET** soft key



You can also reset the lift-off with M149.

The control automatically resets the **FUNCTION LIFTOFF** function at the end of a program.



# 13

**Multiple-Axis-  
Machining**

## 13.1 Functions for multiple axis machining

This chapter summarizes the control functions for multiple axis machining:

<b>Control function</b>	<b>Description</b>	<b>Page</b>
<b>PLANE</b>	Define machining in the tilted working plane	535
<b>M116</b>	Feed rate of rotary axes	565
<b>PLANE/M128</b>	Inclined-tool machining	563
<b>FUNCTION TCPM</b>	Define the behavior of the control when positioning the rotary axes (enhancement of M128)	573
<b>M126</b>	Shortest-path traverse of rotary axes	566
<b>M94</b>	Reduce display value of rotary axes	567
<b>M128</b>	Define the behavior of the control when positioning the rotary axes	568
<b>M138</b>	Selection of tilted axes	571
<b>M144</b>	Calculate machine kinematics	572
<b>LN blocks</b>	Three-dimensional tool compensation	579

## 13.2 The PLANE function: Tilting the working plane (option 8)

### Introduction



Refer to your machine manual.

The machine manufacturer must enable the functions for tilting the working plane!

You can only use the **PLANE** function in its entirety on machines having at least two rotary axes (table axes, head axes or combined axes). An exception is the **PLANE AXIAL** function. **PLANE AXIAL** can also be used on a machine which has only one programmed rotary axis.

The **PLANE** functions provide powerful options to define tilted working planes in various ways.

The parameter definition of the **PLANE** functions is subdivided into two parts:

- The geometric definition of the plane, which is different for each of the available **PLANE** functions.
- The positioning behavior of the **PLANE** function, which is independent of the plane definition and is identical for all **PLANE** functions

**Further information:** "Specifying the positioning behavior of the PLANE function", page 554

### NOTICE

#### Danger of collision!

Cycle **8 MIRROR IMAGE** may have different effects in conjunction with the **Tilt working plane** function. The effect mainly depends on the programming sequence, the mirrored axes and the tilting function used. There is a danger of collision during the tilting operation and subsequent machining.

- ▶ Check the sequence and positions using a graphic simulation
- ▶ Carefully test the NC program or program section in the **Program run, single block** operating mode

#### Examples

- 1 Cycle **8 MIRROR IMAGE** programmed before the tilting function without rotary axes:
  - The tilt of the **PLANE** function used (except **PLANE AXIAL**) is mirrored
  - The mirroring is effective after the tilt with **PLANE AXIAL** or Cycle **19**
- 2 Cycle **8 MIRROR IMAGE** programmed before the tilting function with a rotary axis:
  - The mirrored rotary axis has no effect on the tilt specified in the **PLANE** function used, because only the movement of the rotary axis is mirrored











Operating and programming notes:

- The actual-position-capture function is not possible with an active tilted working plane.
- If you use the **PLANE** function when **M120** is active, the control automatically rescinds the radius compensation, which also rescinds the **M120** function.
- Always use **PLANE RESET** to cancel **PLANE** functions. Entering 0 in all **PLANE** parameters (e.g. all three spatial angles) exclusively resets the angles, but not the function.
- If you restrict the number of tilting axes with the **M138** function, your machine may provide only limited tilting possibilities. The machine tool builder will decide whether the control takes the angles of deselected axes into account or sets them to 0.
- The control only supports tilting the working plane with spindle axis Z.





## Overview

Most **PLANE** functions (except **PLANE AXIAL**) can be used to describe the desired working plane independently of the rotary axes available on your machine. The following possibilities are available:

Soft key	Function	Required parameters	Page
	<b>SPATIAL</b>	Three spatial angles: <b>SPA</b> , <b>SPB</b> , and <b>SPC</b>	540
	<b>PROJECTED</b>	Two projection angles: <b>PROPR</b> and <b>PROMIN</b> and a rotation angle <b>ROT</b>	542
	<b>EULER</b>	Three Euler angles: precession ( <b>EULPR</b> ), nutation ( <b>EULNU</b> ) and rotation ( <b>EULROT</b> ),	544
	<b>VECTOR</b>	Normal vector for defining the plane and base vector for defining the direction of the tilted X axis	546
	<b>POINTS</b>	Coordinates of any three points in the plane to be tilted	549
	<b>RELATIVE</b>	Single, incrementally effective spatial angle	551
	<b>AXIAL</b>	Up to three absolute or incremental axis angles <b>A,B,C</b>	552
	<b>RESET</b>	Reset the PLANE function	539

## Running an animation

To familiarize yourself with the various definition possibilities of each **PLANE** function, you can start animated sequences via soft key. To do so, first enter animation mode and then select the desired **PLANE** function. While the animation plays, the control highlights the soft key of the selected **PLANE** function with a blue color.

Soft key	Function
	Switch on the animation mode
	Select the desired animation (highlighted in blue)

### Defining the PLANE function

- ▶ **SPEC FCT** Show the soft-key row with special functions
- ▶ **TILT MACHINING PLANE** Press the **TILT MACHINING PLANE** soft key
- ▶ The control display the available **PLANE** functions in the soft-key row.
- ▶ Select the **PLANE** function

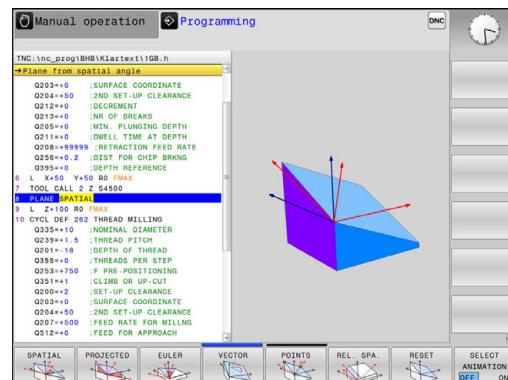

### Selecting functions

- ▶ Press the soft key linked to the desired function
- ▶ The control continues the dialog and prompts you for the required parameters.

### Selecting the function while animation is active

- ▶ Press the soft key linked to the desired function
- ▶ The control plays the animation.
- ▶ To apply the currently active function, press the soft key of that function again or press the **ENT** key

### Position display

As soon as a **PLANE** function (except **PLANE AXIAL**) is active, the control shows the calculated spatial angle in the additional status display.

In the Distance-To-Go display (**ACTDST** and **REFDST**) the control shows, during tilting (**MOVE** or **TURN** mode) in the rotary axis, the distance to go to the calculated final position of the rotary axis.

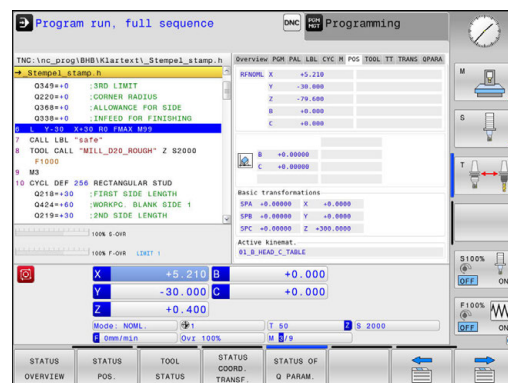

## Resetting PLANE function

### Example

25 PLANE RESET MOVE DIST50 F1000

SPEC  
FCT

- ▶ Show the soft-key row with special functions

TILT  
MACHINING  
PLANE

- ▶ Press the **TILT MACHINING PLANE** soft key
- ▶ The control displays the available **PLANE** functions in the soft-key row

RESET

- ▶ Select the reset function

MOVE

- ▶ Specify whether the control should automatically move the tilting axes to the home position (**MOVE** or **TURN**) or not (**STAY**)

**Further information:** "Automatic positioning: MOVE/TURN/STAY (entry is mandatory)", page 555

END  
D

- ▶ Press the **END** key.



The **PLANE RESET** function resets the active tilt and the angles (**PLANE** function or Cycle **19**) (angle = 0 and function inactive). It does not need to be defined more than once.

Deactivate tilting in the **Manual operation** operating mode in the **3D ROT** menu.

**Further information:** "Activating manual tilting:", page 690

## Defining the working plane with the spatial angle: PLANE SPATIAL

### Application

Spatial angles define a working plane through up to three rotations in the non-tilted workpiece coordinate system (**tilting sequence A-B-C**).

Most users assume three successive rotations in the reversed order (**tilting sequence C-B-A**).

The result is identical for both perspectives, as the following comparison shows.

### Example

**PLANE SPATIAL SPA+45 SPB+0 SPC+90 ...**

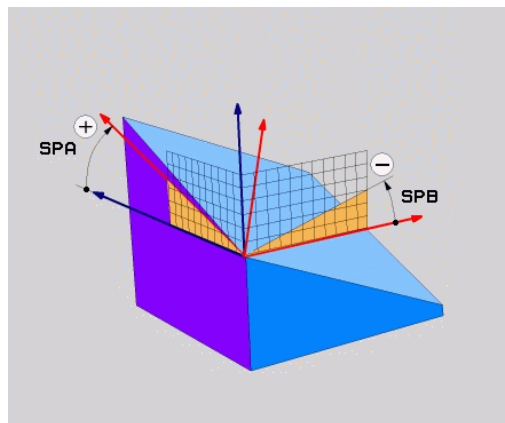

#### A-B-C

Home position A0° B0° C0°

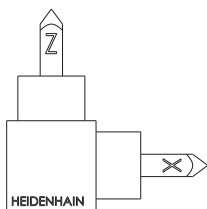

A+45°

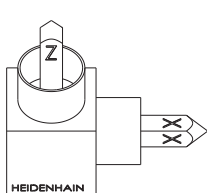

B+0°

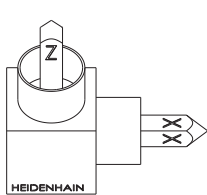

C+90°

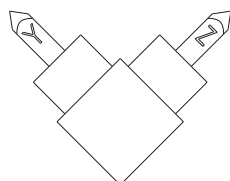

#### C-B-A

Home position A0° B0° C0°

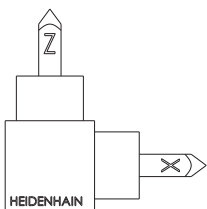

C+90°

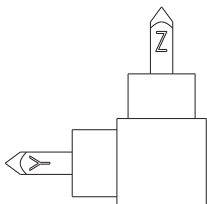

B+0°

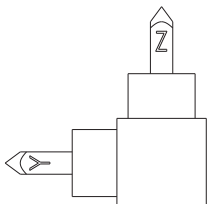

A+45°

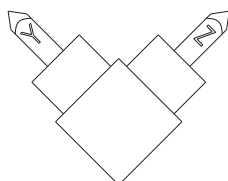

Comparison of the tilting orders:

■ **Tilting order A-B-C:**

- 1 Tilt about the non-tilted X axis of the workpiece coordinate system
- 2 Tilt about the non-tilted Y axis of the workpiece coordinate system
- 3 Tilt about the non-tilted Z axis of the workpiece coordinate system

■ **Tilting order C-B-A:**

- 1 Tilt about the non-tilted Z axis of the workpiece coordinate system
- 2 Tilt about the tilted Y axis
- 3 Tilt about the tilted X axis



Programming notes:

- You must always define all three spatial angles **SPA**, **SPB** and **SPC**, even if one or more have the value 0.
- Depending on the machine, Cycle **19** requires you to enter spatial angles or axis angles. If the configuration (machine parameter setting) allows the input of spatial angles, the angle definition is the same in Cycle **19** and in the **PLANE SPATIAL** function.
- You can select the desired positioning behavior.  
**Further information:** "Specifying the positioning behavior of the PLANE function", page 554

### Input parameters

#### Example

```
5 PLANE SPATIAL SPA+27 SPB+0 SPC+45 .....
```



- ▶ **Spatial angle A?:** Rotational angle **SPA** about the (non-tilted) X axis. Input range from -359.9999 to +359.9999
- ▶ **Spatial angle B?:** Rotational angle **SPB** about the (non-tilted) Y axis. Input range from -359.9999 to +359.9999
- ▶ **Spatial angle C?:** Rotational angle **SPC** about the (non-tilted) Z axis. Input range from -359.9999 to +359.9999
- ▶ Continue with the positioning properties  
**Further information:** "Specifying the positioning behavior of the PLANE function", page 554

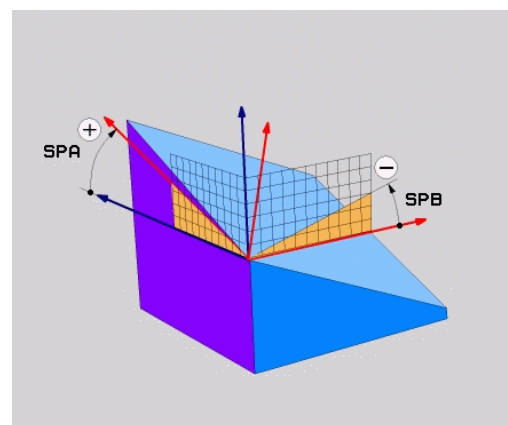

**Abbreviations used**

Abbreviation	Meaning
SPATIAL	In space
SPA	<b>Spatial A:</b> Rotation about the (non-tilted) X axis
SPB	<b>Spatial B:</b> Rotation about the (non-tilted) Y axis
SPC	<b>Spatial C:</b> Rotation about the (non-tilted) Z axis

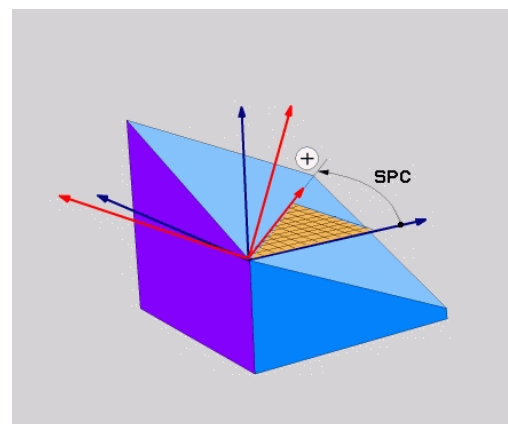
**Defining the working plane with the projection angle: PLANE PROJECTED****Application**

Projection angles define a working plane by specifying two angles that you can communicate by projection of the 1st coordinate plane (Z/X on tool axis Z) and 2nd coordinate plane (Y/Z on tool axis Z) to the working levels to be defined.

**Programming notes:**

- The projection angles correspond to the angle projections on the planes of a rectangular coordinate system. The angles at the outer faces of the workpiece only are identical to the projection angles if the workpiece is rectangular. Thus, with workpieces that are not rectangular, the angle specifications from the engineering drawing often differ from the actual projection angles.
- You can select the desired positioning behavior.  
**Further information:** "Specifying the positioning behavior of the PLANE function", page 554

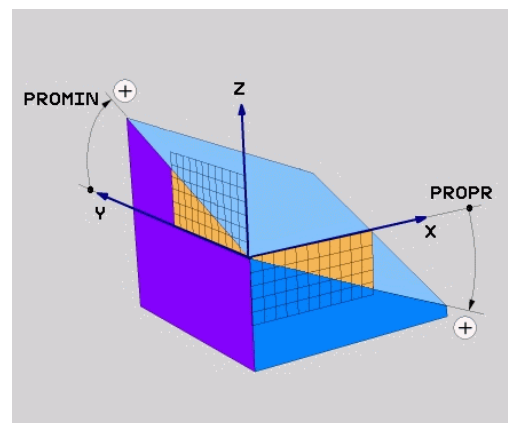

**Input parameters**

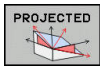

- ▶ **Projection angle on 1st Coordinate plane?:**  
Projected angle of the tilted machining plane in the 1st coordinate plane of the untilted coordinate system (Z/X for tool axis Z). Input range: from  $-89.9999^\circ$  to  $+89.9999^\circ$ . The  $0^\circ$  axis is the principal axis of the active working plane (X for tool axis Z, positive direction)
- ▶ **Proj. angle on 2nd Coordinate plane?:**  
Projected angle in the 2nd coordinate plane of the untilted coordinate system (Y/Z for tool axis Z). Input range: from  $-89.9999^\circ$  to  $+89.9999^\circ$ . The  $0^\circ$  axis is the minor axis of the active machining plane (Y for tool axis Z)
- ▶ **ROT angle of tilted plane?:** Rotation of the tilted coordinate system around the tilted tool axis (corresponds to a rotation with Cycle 10 ROTATION). The rotation angle is used to simply specify the direction of the principal axis of the working plane (X for tool axis Z, Z for tool axis Y). Input range:  $-360^\circ$  to  $+360^\circ$
- ▶ Continue with the positioning properties  
**Further information:** "Specifying the positioning behavior of the PLANE function", page 554

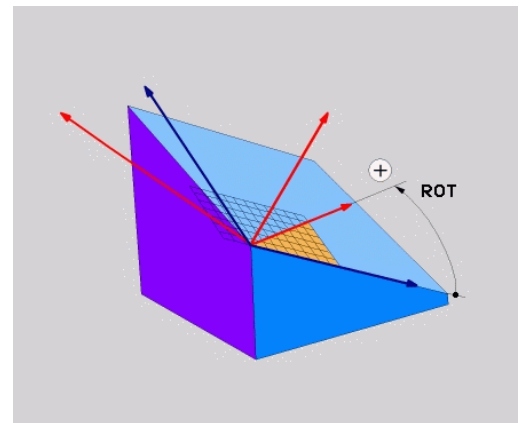
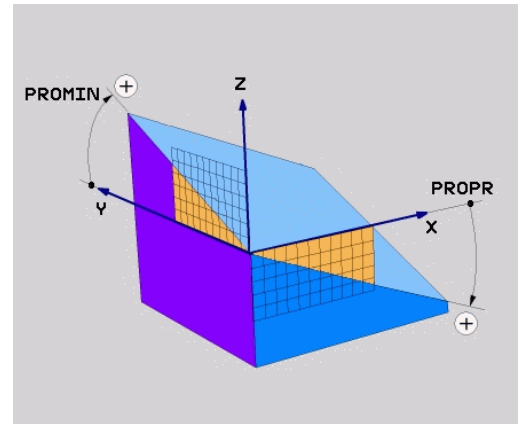

**Example**

```
5 PLANE PROJECTED PROPR+24 PROMIN+24 ROT+30 .....
```

Abbreviations used:

<b>PROJECTED</b>	Projected
<b>PROPR</b>	Principal plane
<b>PROMIN</b>	Minor plane
<b>ROT</b>	Rotation

## Defining the working plane with the Euler angle: PLANE EULER

### Application

Euler angles define a machining plane through up to three **rotations about the respectively tilted coordinate system**. The Swiss mathematician Leonhard Euler defined these angles.



You can select the desired positioning behavior.

**Further information:** "Specifying the positioning behavior of the PLANE function", page 554

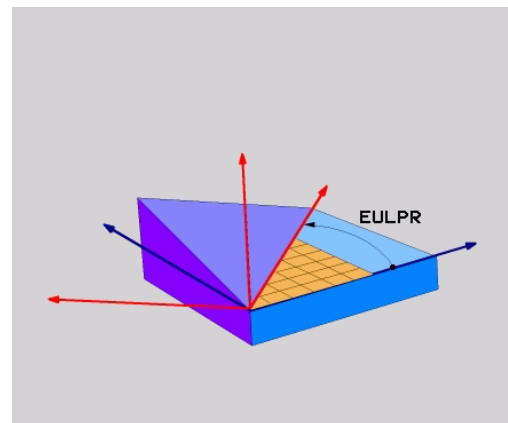

### Input parameters

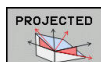

- ▶ **Rot. angle Main coordinate plane?:** Rotary angle **EULPR** around the Z axis. Please note:
  - Input range:  $-180.0000^\circ$  to  $180.0000^\circ$
  - The  $0^\circ$  axis is the X axis
- ▶ **Tilting angle tool axis?:** Tilting angle **EULNUT** of the coordinate system around the X axis shifted by the precession angle. Please note:
  - Input range:  $0^\circ$  to  $180.0000^\circ$
  - The  $0^\circ$  axis is the Z axis
- ▶ **ROT angle of tilted plane?:** Rotation **EULROT** of the tilted coordinate system around the tilted Z axis (corresponds to a rotation with Cycle 10 ROTATION). Use the rotation angle to simply define the direction of the X axis on the tilted working plane. Please note:
  - Input range:  $0^\circ$  to  $360.0000^\circ$
  - The  $0^\circ$  axis is the X axis
- ▶ Continue with the positioning properties  
**Further information:** "Specifying the positioning behavior of the PLANE function", page 554

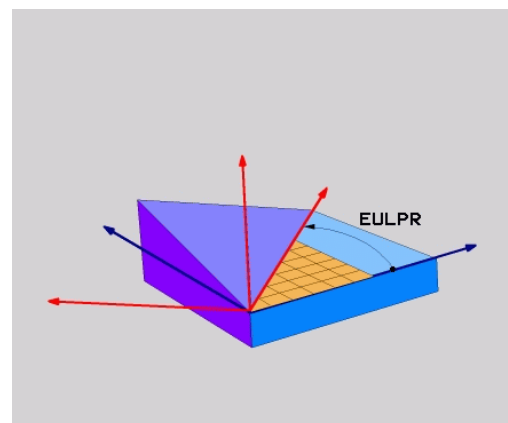

### Example

```
5 PLANE EULER EULPR45 EULNU20 EULROT22 .....
```



**Abbreviations used**

Abbreviation	Meaning
<b>EULER</b>	Swiss mathematician who defined these angles
<b>EULPR</b>	<b>P</b> recession angle: angle describing the rotation of the coordinate system around the Z axis
<b>EULNU</b>	<b>N</b> utation angle: angle describing the rotation of the coordinate system around the X axis shifted by the precession angle
<b>EULROT</b>	<b>R</b> otation angle: angle describing the rotation of the tilted machining plane around the tilted Z axis

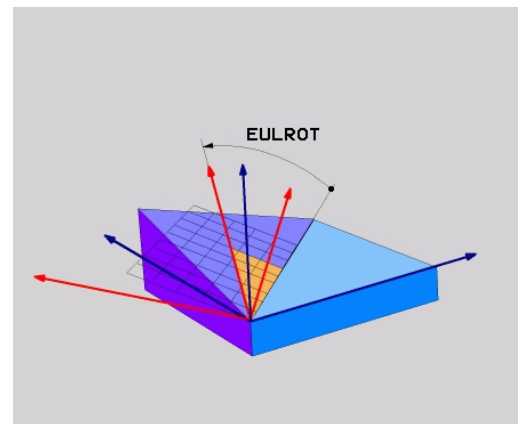
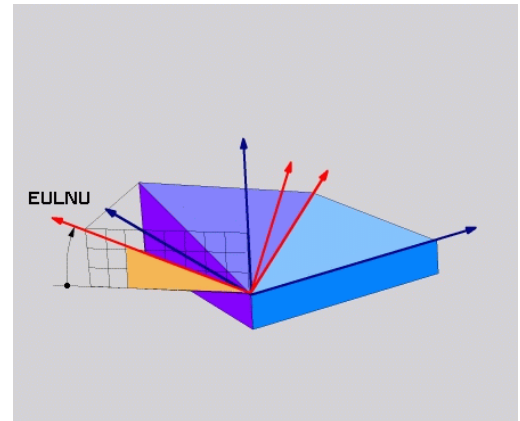

## Defining the working plane with two vectors: PLANE VECTOR

### Application

You can use the definition of a working plane via **two vectors** if your CAD system can calculate the base vector and normal vector of the tilted machining plane. A normalized input is not necessary. The control internally calculates the normal, so you can enter values between -9.999999 and +9.999999.

The base vector required for the definition of the machining plane is defined by the components **BX**, **BY** and **BZ**. The normal vector is defined by the components **NX**, **NY** and **NZ**.

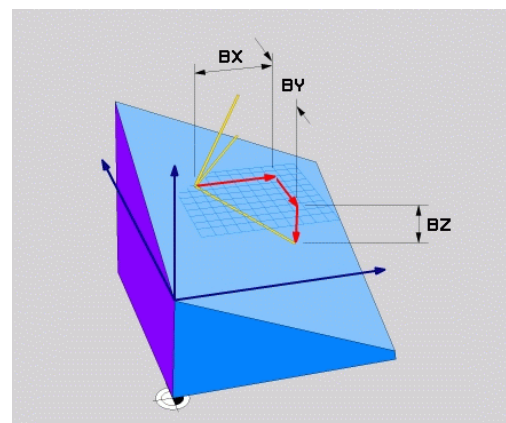

#### Programming notes:

- The control calculates standardized vectors from the values you enter.
- The normal vector defines the slope and the orientation of the working plane. The base vector defines the orientation of the main axis X in the defined working plane. To ensure that the definition of the working plane is unambiguous, you must program the vectors perpendicular to each other. The machine tool builder defines how the control will behave for vectors that are not perpendicular.
- The programmed normal vector must not be too short, e.g. all directional components having a length of 0 or 0.0000001. In this case, the control would not be able to determine the slope. Machining is aborted and an error message is displayed. This behavior is independent of the configuration of the machine parameters.
- You can select the desired positioning behavior.

**Further information:** "Specifying the positioning behavior of the PLANE function", page 554



Refer to your machine manual.

The machine tool builder configures the behavior of the control with vectors that are not perpendicular.

Alternatively to generating the default error message, the control can correct (or replace) the base vector that is not perpendicular. This correction (or replacement) does not affect the normal vector.

Default correction behavior of the control if the base vector is not perpendicular:

- The base vector is projected along the normal vector onto the working plane (defined by the normal vector).

Correction behavior of the control if the base vector is not perpendicular and too short, parallel or antiparallel to the normal vector:

- If the normal vector has no X component, the base vector corresponds to the original X axis
- If the normal vector has no Y component, the base vector corresponds to the original Y axis

**Input parameters**



- ▶ **X component of base vector?:** X component **BX** of the base vector B; input range: from -9.9999999 to +9.9999999
- ▶ **Y component of base vector?:** Y component **BY** of the base vector B; input range: from -9.9999999 to +9.9999999
- ▶ **Z component of base vector?:** Z component **BZ** of the base vector B; input range: from -9.9999999 to +9.9999999
- ▶ **X component of normal vector?:** X component **NX** of the normal vector N; input range: from -9.9999999 to +9.9999999
- ▶ **Y component of normal vector?:** Y component **NY** of the normal vector N; input range: from -9.9999999 to +9.9999999
- ▶ **Z component of normal vector?:** Z component **NZ** of the normal vector N; input range: from -9.9999999 to +9.9999999
- ▶ Continue with the positioning properties  
**Further information:** "Specifying the positioning behavior of the PLANE function", page 554

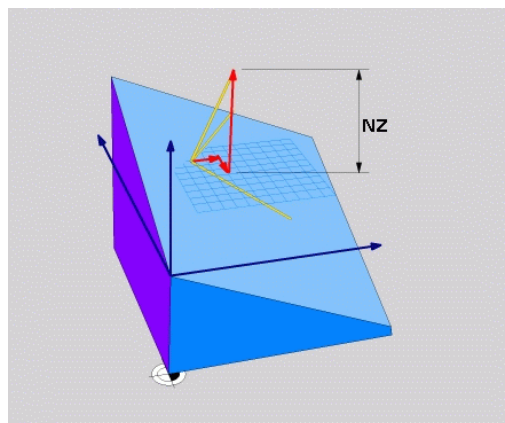
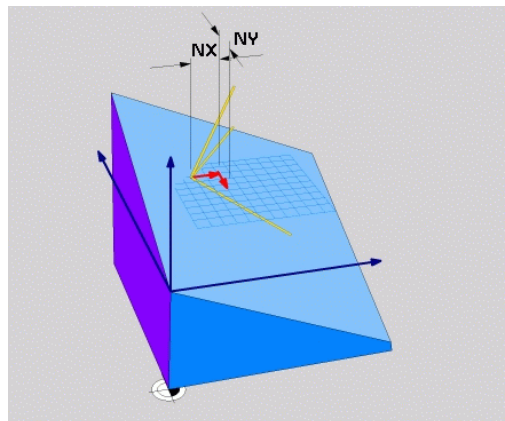
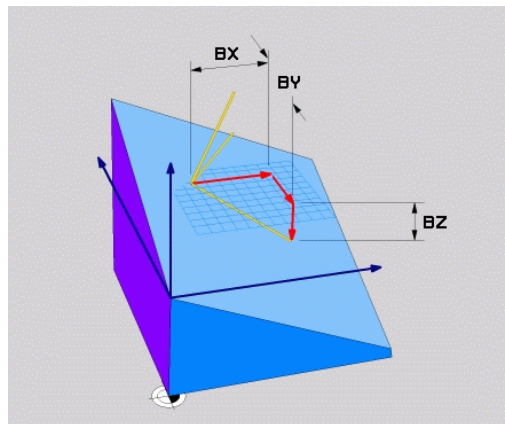

**Example**

```
5 PLANE VECTOR BX0.8 BY-0.4 BZ-0.42 NX0.2 NY0.2 NZ0.92 ..
```

**Abbreviations used**

Abbreviation	Meaning
VECTOR	Vector
BX, BY, BZ	Base vector : <b>X</b> , <b>Y</b> , and <b>Z</b> components
NX, NY, NZ	Normal vector : <b>X</b> , <b>Y</b> , and <b>Z</b> components

## Defining the working plane via three points: PLANE POINTS

### Application

A working plane can be uniquely defined by entering **any three points P1 to P3 in this plane**. This possibility is realized in the **PLANE POINTS** function.



Programming notes:

- The three points define the slope and orientation of the plane. The position of the active datum is not changed through **PLANE POINTS**.
- Point 1 and Point 2 determine the orientation of the tilted main axis X (for tool axis Z).
- Point 3 defines the slope of the tilted working plane. In the defined working plane, the Y axis is automatically oriented perpendicularly to the main axis X. The position of Point 3 thus also determines the orientation of the tool axis and consequently the orientation of the working plane. To have the positive tool axis pointing away from the workpiece, Point 3 must be located above the connection line between Point 1 and Point 2 (right-hand rule).
- You can select the desired positioning behavior.  
**Further information:** "Specifying the positioning behavior of the PLANE function", page 554

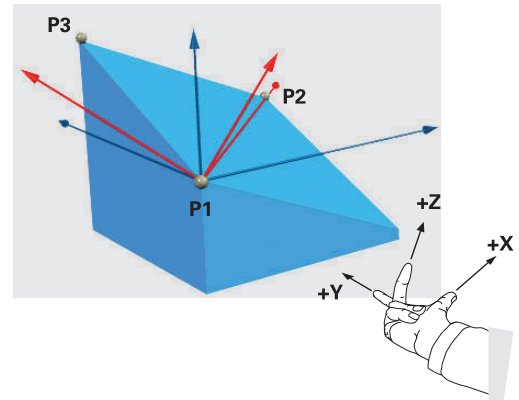

Input parameters



- ▶ **X coordinate of 1stplane point?:** X coordinate **P1X** of the 1st plane point
- ▶ **Y coordinate of 1stplane point?:** Y coordinate **P1Y** of the 1st plane point
- ▶ **Z coordinate of 1stplane point?:** Z coordinate **P1Z** of the 1st plane point
- ▶ **X coordinate of 2ndplane point?:** X coordinate **P2X** of the 2nd plane point
- ▶ **Y coordinate of 2ndplane point?:** Y coordinate **P2Y** of the 2nd plane point
- ▶ **Z coordinate of 2ndplane point?:** Z coordinate **P2Z** of the 2nd plane point
- ▶ **X coordinate of 3rdplane point?:** X coordinate **P3X** of the 3rd plane point
- ▶ **Y coordinate of 3rdplane point?:** Y coordinate **P3Y** of the 3rd plane point
- ▶ **Z coordinate of 3rdplane point?:** Z coordinate **P3Z** of the 3rd plane point
- ▶ Continue with the positioning properties  
**Further information:** "Specifying the positioning behavior of the PLANE function", page 554

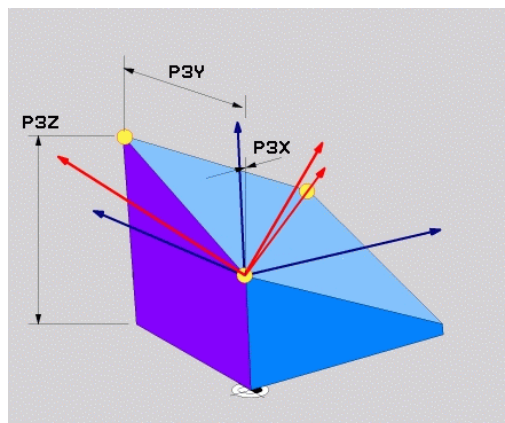
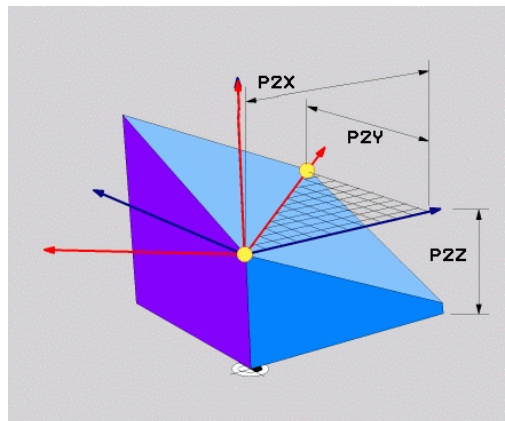
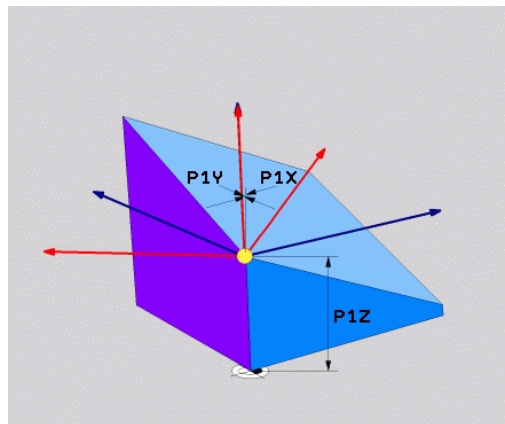

Example

```
5 PLANE POINTS P1X+0 P1Y+0 P1Z+20 P2X+30 P2Y+31 P2Z+20
P3X+0 P3Y+41 P3Z+32.5 .....
```

Abbreviations used

Abbreviation	Meaning
POINTS	Points

## Defining the working plane via a single incremental spatial angle: PLANE RELATIV

### Application

Use a relative spatial angle when an already active tilted working plane is to be tilted by **another rotation**. Example: machining a 45° chamfer on a tilted plane.



Programming notes:

- The defined angle is always in effect in respect to the active working plane, regardless of the tilting function you used before.
- You can program any number of **PLANE RELATIV** functions in a row..
- If you want to return the working plane to the orientation that was active before the **PLANE RELATIV** function, define the same **PLANE RELATIV** function again but enter the value with the opposite algebraic sign.
- If you use **PLANE RELATIV** without previous tilting, **PLANE RELATIV** will be effective directly in the workpiece coordinate system. In this case, you can tilt the original working plane by entering a defined spatial angle in the **PLANE RELATIV** function.
- You can select the desired positioning behavior.  
**Further information:** "Specifying the positioning behavior of the PLANE function", page 554

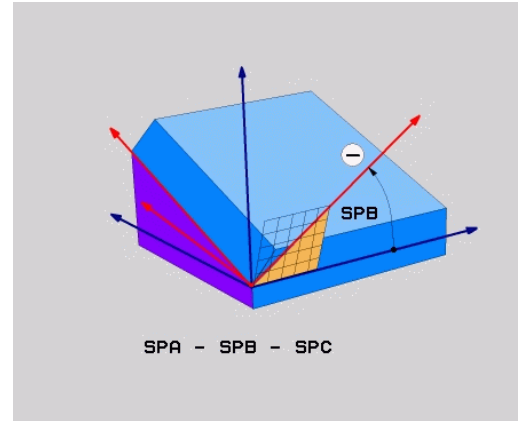

### Input parameters



- ▶ **Incremental angle?:** Spatial angle by which the active machining plane is to be rotated. Use a soft key to select the axis to be rotated around. Input range: -359.9999° to +359.9999°
- ▶ Continue with the positioning properties  
**Further information:** "Specifying the positioning behavior of the PLANE function", page 554

### Example

5 PLANE RELATIV SPB-45 .....

### Abbreviations used

Abbreviation	Meaning
RELATIVE	Relative to

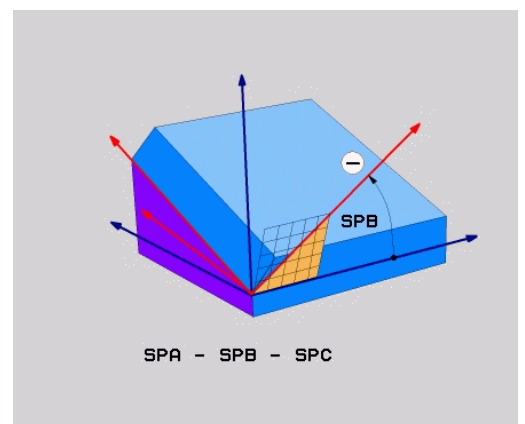

## Tilting the working plane through axis angle: PLANE AXIAL

### Application

The **PLANE AXIAL** function defines both the slope and the orientation of the working plane and the nominal coordinates of the rotary axes.



**PLANE AXIAL** can also be used on machines that have only one rotary axis.

The input of nominal coordinates (axis angle input) is advantageous in that it provides an unambiguously defined tilting situation based on defined axis positions. Spatial angles entered without an additional definition are often mathematically ambiguous. Without the use of a CAM system, entering axis angles, in most cases, only makes sense if the rotary axes are positioned perpendicularly.



Refer to your machine manual.

If your machine allows spatial angle definitions, you can continue your programming with **PLANE RELATIV** after **PLANE AXIAL**.



Programming notes:

- The axis angles must correspond to the axes present on the machine. If you try to program axis angles for rotary axes that do not exist on the machine, the control will generate an error message.
- Use **PLANE RESET** to reset the **PLANE AXIAL** function. Entering 0 only resets the axis angle, but does not deactivate the tilting function.
- The axis angles of the **PLANE AXIAL** function are modally effective. If you program an incremental axis angle, the control will add this value to the currently effective axis angle. If you program two different rotary axes in two successive **PLANE AXIAL** functions, the new working plane is derived from the two defined axis angles.
- The **SEQ**, **TABLE ROT** and **COORD ROT** functions have no effect in conjunction with **PLANE AXIAL**.
- The **PLANE AXIAL** function does not take basic rotation into account.

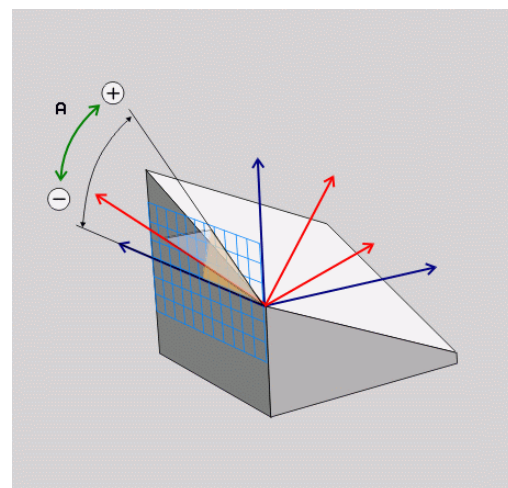



## Input parameters

### Example

5 PLANE AXIAL B-45 .....

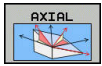

- ▶ **Axis angle A?**: Axis angle **to which** the A axis is to be tilted. If entered incrementally, it is the angle **by which** the A axis is to be tilted from its current position. Input range:  $-99999.9999^\circ$  to  $+99999.9999^\circ$
- ▶ **Axis angle B?**: Axis angle **to which** the B axis is to be tilted. If entered incrementally, it is the angle **by which** the B axis is to be tilted from its current position. Input range:  $-99999.9999^\circ$  to  $+99999.9999^\circ$
- ▶ **Axis angle C?**: Axis angle **to which** the C axis is to be tilted. If entered incrementally, it is the angle **by which** the C axis is to be tilted from its current position. Input range:  $-99999.9999^\circ$  to  $+99999.9999^\circ$
- ▶ Continue with the positioning properties  
**Further information:** "Specifying the positioning behavior of the PLANE function", page 554

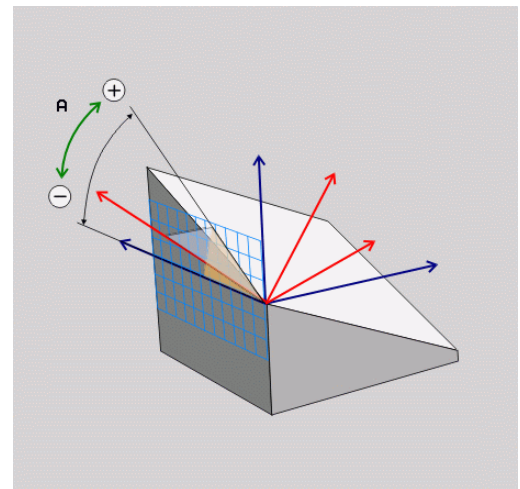

### Abbreviations used

Abbreviation	Meaning
AXIAL	In the axial direction

## Specifying the positioning behavior of the PLANE function

### Overview

Independently of which PLANE function you use to define the tilted machining plane, the following functions are always available for the positioning behavior:

- Automatic positioning
- Selection of alternate tilting possibilities (not with **PLANE AXIAL**)
- Selection of the type of transformation (not with **PLANE AXIAL**)

### NOTICE

#### Danger of collision!

Cycle **8 MIRROR IMAGE** may have different effects in conjunction with the **Tilt working plane** function. The effect mainly depends on the programming sequence, the mirrored axes and the tilting function used. There is a danger of collision during the tilting operation and subsequent machining.

- ▶ Check the sequence and positions using a graphic simulation
- ▶ Carefully test the NC program or program section in the **Program run, single block** operating mode

#### Examples

- 1 Cycle **8 MIRROR IMAGE** programmed before the tilting function without rotary axes:
  - The tilt of the **PLANE** function used (except **PLANE AXIAL**) is mirrored
  - The mirroring is effective after the tilt with **PLANE AXIAL** or Cycle **19**
- 2 Cycle **8 MIRROR IMAGE** programmed before the tilting function with a rotary axis:
  - The mirrored rotary axis has no effect on the tilt specified in the **PLANE** function used, because only the movement of the rotary axis is mirrored

**Automatic positioning: MOVE/TURN/STAY (entry is mandatory)**

After you have entered all parameters for the plane definition, you must specify how the rotary axes will be positioned to the calculated axis values:

- |      |                                                                                                                                                                                                                                                                                                            |
|------|------------------------------------------------------------------------------------------------------------------------------------------------------------------------------------------------------------------------------------------------------------------------------------------------------------|
| MOVE | <ul style="list-style-type: none"> <li>▶ The PLANE function is to automatically position the rotary axes to the calculated position values. The position of the tool relative to the workpiece remains the same.</li> <li>▶ The control carries out a compensation movement in the linear axes.</li> </ul> |
| TURN | <ul style="list-style-type: none"> <li>▶ The PLANE function is to automatically position the rotary axes to the calculated position values, but only the rotary axes are positioned.</li> <li>▶ The control does <b>not</b> carry out a compensation movement for the linear axes.</li> </ul>              |
| STAY | <ul style="list-style-type: none"> <li>▶ You will position the rotary axes later in a separate positioning block</li> </ul>                                                                                                                                                                                |

If you selected the **MOVE** option (the **PLANE** function is used to position the axes automatically), the following two parameters: **Dist. tool tip - center of rot.** and **Feed rate? F =** are still to be defined.

If you selected the **TURN** option (the **PLANE** function is used to position the axes automatically), the following parameter: **Feed rate? F =** is still to be defined.

As an alternative to defining a feed rate **F** directly by entering a numerical value, you can also position the axes with **FMAX** (rapid traverse) or **FAUTO** (feed rate from the **TOOL CALL** block).



If you use **PLANE** together with **STAY**, you have to position the rotary axes in a separate block after the **PLANE** function.

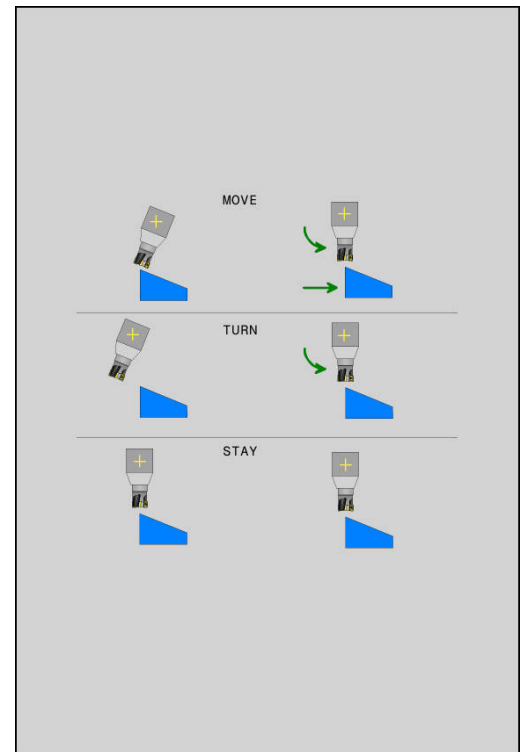

- ▶ **Dist. tool tip - center of rot.** (incremental): The **DIST** parameter shifts the center of rotation of the movement relative to the current position of the tool tip.
  - If the tool is already at the given distance to the workpiece before positioning, then the tool is at the same relative position after positioning (see figure at center right, **1** = DIST)
  - If the tool is not at the given distance to the workpiece before positioning, then the tool is offset relatively from the original position after positioning (see figure at bottom right, **1** = DIST)
- > The control tilts the tool (or table) relative to the tool tip.
- ▶ **Feed rate? F=:** Contour speed at which the tool should be positioned
- ▶ **Retraction length in the tool axis?:** The retraction path **MB** is effective incrementally from the current tool position in the active tool axis direction that the control approaches **before tilting**. **MB MAX** positions the tool just before the software limit switch.

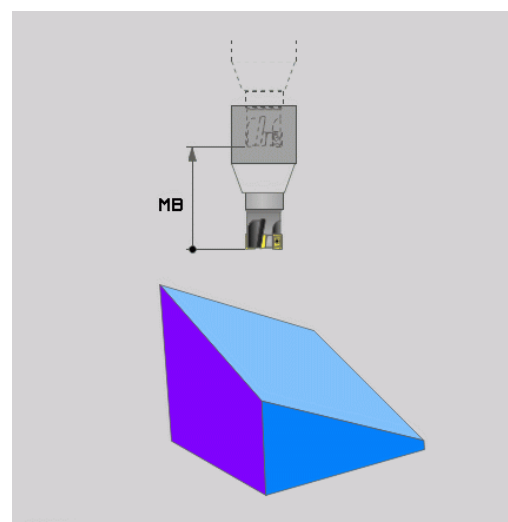
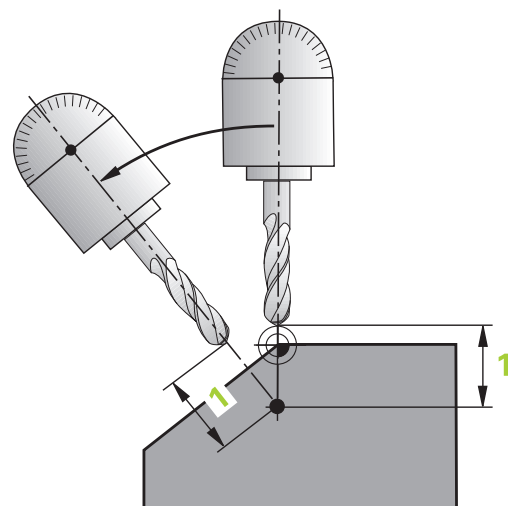
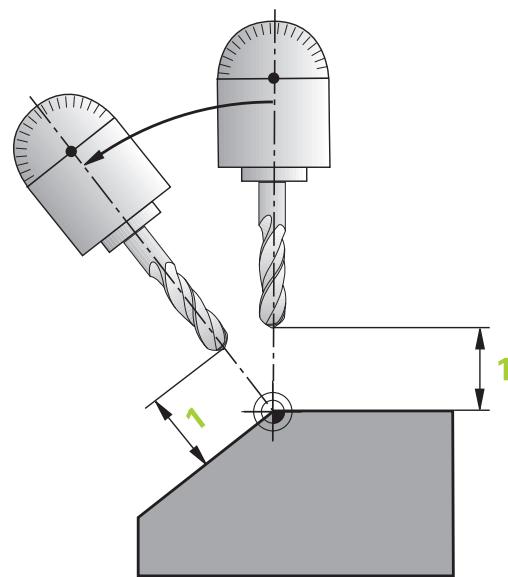

**Positioning the rotary axes in a separate block**

Proceed as follows if you want to position the rotary axes in a separate positioning block (option **STAY** selected):

**NOTICE****Danger of collision!**

The control does not automatically check whether collisions can occur between the tool and the workpiece. Incorrect or no pre-positioning before tilting the tool to position can lead to a risk of collision during the tilting movement!

- ▶ Program a safe position of the tool before the tilting movement.
  - ▶ Carefully test the NC program or program section in the **Program run, single block** operating mode
- 
- ▶ Select any **PLANE** function, and define automatic tilting to position with the **STAY** option. During program execution, the control calculates the position values of the rotary axes present on the machine, and stores them in the system parameters Q120 (A axis), Q121 (B axis) and Q122 (C axis)
  - ▶ Define the positioning block with the angular values calculated by the control.

**Example: Tilt a machine with a rotary table C and a tilting table A to a spatial angle of B+45**

...	
12 L Z+250 R0 FMAX	Position at clearance height
13 PLANE SPATIAL SPA+0 SPB+45 SPC+0 STAY	Define and activate the PLANE function
14 L A+Q120 C+Q122 F2000	Position the rotary axis with the values calculated by the control.
...	Define machining in the tilted working plane

### Selection of alternate tilting possibilities: SEQ +/- (entry optional)

The orientation you define for the working plane is used by the control to calculate the appropriate position of the rotary axes on your machine. In general, there are always two possible solutions.

Use the **SEQ** switch to specify which possible solution the control should use:

- **SEQ+** positions the master axis so that it assumes a positive angle. The master axis is the first rotary axis going out from the tool or the last rotary axis going out from the table (depending on the machine configuration)
- **SEQ-** positions the master axis so that it assumes a negative angle.

If the solution you chose with **SEQ** is not within the machine's range of traverse, the control displays the **Entered angle not permitted** error message.



When the function is used, the switch is nonfunctional.

If you do not define **SEQ**, the control determines the solution as follows:

- 1 The control first checks whether both possible solutions are within the traverse range of the rotary axes.
- 2 If they are, then the control selects the shortest possible solution based on the current position of the rotary axes.
- 3 If only one solution is within the traverse range, the control selects this solution
- 4 If neither solution is within the traverse range, the control displays the **Entered angle not permitted** error message.

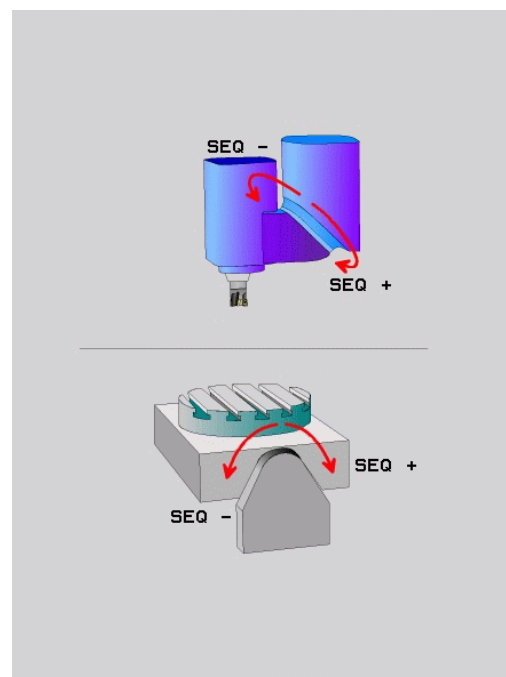

**Example for machine with rotary table C and tilting table A.  
Programmed function: PLANE SPATIAL SPA+0 SPB+45 SPC+0**

Limit switch	Starting position	SEQ	Resulting axis position
None	A+0, C+0	not prog.	A+45, C+90
None	A+0, C+0	+	A+45, C+90
None	A+0, C+0	-	A-45, C-90
None	A+0, C-105	not prog.	A-45, C-90
None	A+0, C-105	+	A+45, C+90
None	A+0, C-105	-	A-45, C-90
-90 < A < +10	A+0, C+0	not prog.	A-45, C-90
-90 < A < +10	A+0, C+0	+	Error message
None	A+0, C-135	+	A+45, C+90

**Selecting the type of transformation (entry optional)**

The transformation types **COORD ROT** and **TABLE ROT** influence the orientation of the working plane coordinate system through the axis position of a so-called free rotary axis.

Any rotary axis becomes a free rotary axis with the following constellation:

- the rotary axis has no effect on the tool angle of inclination because the rotation axis and tool axis are parallel in the tilting situation
- the rotary axis is the first rotary axis in the kinematic chain starting from the workpiece

The effect of the transformation types **COORD ROT** and **TABLE ROT** therefore depends on the programmed spatial angles and the machine kinematics.

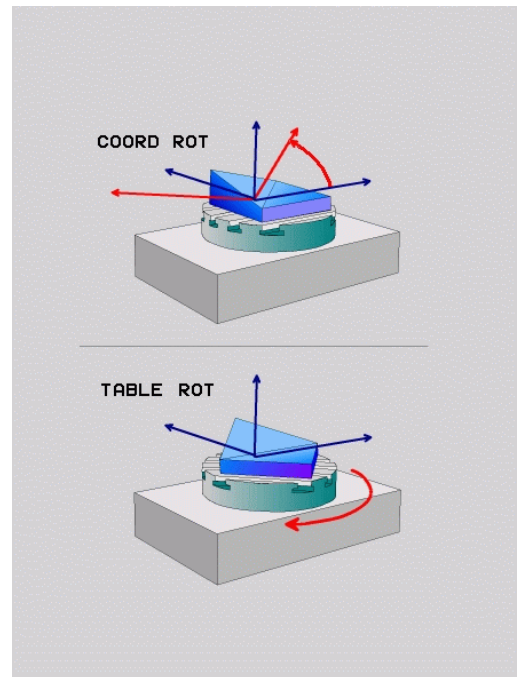

Programming notes:

- If no free rotary axis is created in a tilting situation, the **COORD ROT** and **TABLE ROT** transformation types have no effect
- With the **PLANE AXIAL** function the **COORD ROT** and **TABLE ROT** transformation types have no effect

### Effect with a free rotary axis



#### Programming notes

- For the positioning behavior with the **COORD ROT** and **TABLE ROT** transformation types, it does not matter if the free rotary axis is a table or head axis
- The resulting axis position of the free rotary axis depends on an active basic rotation among other factors
- The orientation of the working plane coordinate system also depends on a programmed rotation, for example with Cycle 10 **ROTATION**

### Soft key

### Effect

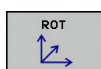

#### **COORD ROT:**

- > The control positions the free rotary axis to 0
- > The control aligns the working plane coordinate system according to the programmed spatial angle

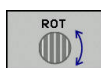

#### **TABLE ROT** with:

- **SPA and SPB equal to 0**
- **SPC equal or unequal to 0**
- > The control aligns the free rotary axis according to the programmed spatial angle
- > The control aligns the working plane coordinate system according to the basic coordinate system

#### **TABLE ROT** with:

- **At least SPA or SPB unequal to 0**
- **SPC equal or unequal to 0**
- > The control does not position the free rotary axis. The position before tilting the working plane is maintained
- > Because the workpiece was not positioned, the control aligns the working plane coordinate system according to the programmed spatial angle



If no transformation type was specified, the control uses the **COORD ROT** transformation type for the **PLANE** functions



**Example**

The example below shows the effect of the **TABLE ROT** transformation type in conjunction with a free rotary axis.

...	
<b>6 L B+45 R0 FMAX</b>	Pre-position rotary axis
<b>7 PLANE SPATIAL SPA-90 SPB+20 SPC+0 TURN F5000 TABLE ROT</b>	Tilt working plane
...	

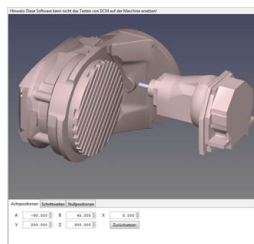
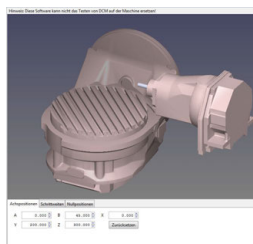
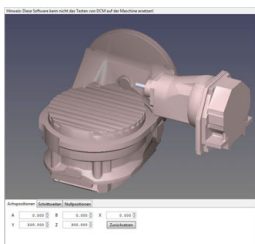
**Origin****A = 0, B = 45****A = -90, B = 45**

- > The control positions the B axis to the axis angle B+45
- > With the programmed tilting situation with SPA-90, the B axis becomes the free rotary axis
- > The control does not position the free rotary axis. The position of the B axis before tilting the working plane is maintained
- > Because the workpiece was not positioned, the control aligns the working plane coordinate system according to the programmed spatial angle SPB+20

## Tilting the working plane without rotary axes



Refer to your machine manual.

This feature must be enabled and adapted by the machine tool builder.

The machine tool builder must take the precise angle into account, e.g. the angle of a mounted angular head in the kinematics description.

You can also orient the programmed working plane perpendicularly to the tool without defining rotary axes, e.g. when adapting the working plane for a mounted angular head.

Use the **PLANE SPATIAL** function and the **STAY** positioning behavior to swivel the working plane to the angle specified by the machine tool builder.

Example of mounted angular head with permanent tool direction Y:

### Example

```
TOOL CALL 5 Z S4500
```

```
PLANE SPATIAL SPA+0 SPB-90 SPC+0 STAY
```



The tilt angle must be precisely adapted to the tool angle, otherwise the control will generate an error message.

## 13.3 Inclined-tool machining in a tilted plane (option 9)

### Function

In combination with **M128** and the new **PLANE** functions, **inclined-tool machining** on a tilted machining plane is now possible. Two possibilities are available for definition:

- Inclined-tool machining via incremental traverse of a rotary axis
- Inclined-tool machining via normal vectors



Inclined-tool machining in a tilted machining plane only works with spherical cutters. If you are using 45° swivel heads and tilting tables, you can also define the incline angle as a spatial angle. Use **FUNCTION TCPM** for this purpose.

**Further information:** "FUNCTION TCPM (option 9)", page 573

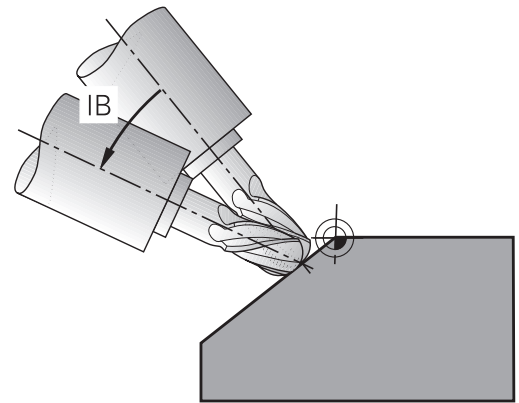

### Inclined-tool machining via incremental traverse of a rotary axis

- ▶ Retract the tool
- ▶ Define any PLANE function; consider the positioning behavior
- ▶ Activate M128
- ▶ Via a straight-line block, traverse to the desired incline angle in the appropriate axis incrementally

### Example

...	
12 L Z+50 R0 FMAX	Position at clearance height
13 PLANE SPATIAL SPA+0 SPB-45 SPC+0 MOVE DIST50 F1000	Define and activate the PLANE function
14 M128	Activate M128
15 L IB-17 F1000	Set the incline angle
...	Define machining in the tilted working plane

## Inclined-tool machining via normal vectors



Only one directional vector can be defined in the **LN** block. This vector defines the incline angle (normal vector **NX, NY, NZ** or tool directional vector **TX, TY, TZ**).

- ▶ Retract the tool
- ▶ Define any PLANE function; consider the positioning behavior
- ▶ Activate M128
- ▶ Execute program with LN blocks in which the tool direction is defined by a vector

### Example

...	
12 L Z+50 R0 FMAX	Position at clearance height
13 PLANE SPATIAL SPA+0 SPB+45 SPC+0 MOVE DIST50 F1000	Define and activate the PLANE function
14 M128	Activate M128
15 LN X+31.737 Y+21.954 Z+33.165 NX+0.3 NY+0 NZ +0.9539 F1000 M3	Set the incline angle with the normal vector
...	Define machining in the tilted working plane

## 13.4 Miscellaneous functions for rotary axes

### Feed rate in mm/min on rotary axes A, B, C: M116 (option 8)

#### Standard behavior

The control interprets the programmed feed rate of a rotary axis in degrees/min (in mm programs and also in inch programs). The feed rate therefore depends on the distance from the tool center to the center of the rotary axis.

The larger this distance becomes, the greater the contouring feed rate.

#### Feed rate in mm/min on rotary axes with M116



Refer to your machine manual.

The machine geometry must be specified by the machine tool builder in the description of kinematics.



Programming notes:

- The **M116** function can be used with table axes and head axes.
- The **M116** function is also effective if the **Tilt working plane** function is active.
- It is not possible to combine the **M128** or **TCPM** functions with **M116**. If you want to activate **M116** for an axis while the **M128** or **TCPM** function is active, you must deactivate the compensating movement for this axis indirectly using **M138**. This is done indirectly because with **M138**, you specify the axis for which the **M128** or **TCPM** function is effective. Thus, **M116** automatically affects the very axis that was not selected with **M138**.  
**Further information:** "Selecting tilting axes: M138", page 571
- Without the **M128** or **TCPM** function, **M116** can be effective for two rotary axes at the same time.

The control interprets the programmed feed rate of a rotary axis in mm/min (or 1/10 inch/min). In this case, the control calculates the feed rate for the block at the start of each block. The feed rate of a rotary axis will not change while the block is executed, even if the tool moves toward the center of the rotary axis.

#### Effect

**M116** is effective in the working plane. Reset **M116** with **M117**. At the end of the program, **M116** is automatically canceled.

**M116** becomes effective at the start of the block.

## Shortest-path traverse of rotary axes: M126

### Standard behavior



Refer to your machine manual.

The positioning behavior of rotary axes is machine-dependent.

The default behavior of the control while positioning rotary axes whose display has been reduced to values less than 360° is dependent on the **shortestDistance** machine parameter (no. 300401). This machine parameter defines whether the control should consider the difference between nominal and actual positions, or whether it should always choose the shortest path to the programmed position (even without M126). Examples:

Actual position	Nominal position	Traverse
350°	10°	-340°
10°	340°	+330°

### Behavior with M126

With **M126**, the control will move a rotary axis, whose display is reduced to values less than 360°, on the shortest path of traverse. Examples:

Actual position	Nominal position	Traverse
350°	10°	+20°
10°	340°	-30°

### Effect

**M126** becomes effective at the start of the block.

To cancel **M126**, enter **M127**. At the end of program, **M126** is automatically canceled.

## Reducing display of a rotary axis to a value less than 360°: M94

### Standard behavior

The control moves the tool from the current angular value to the programmed angular value.

### Example:

Current angular value:	538°
Programmed angular value:	180°
Actual distance of traverse:	-358°

### Behavior with M94

At the start of block, the control first reduces the current angular value to a value less than 360° and then moves the tool to the programmed value. If multiple rotary axes are active, **M94** will reduce the display of all rotary axes. As an alternative, you can specify a rotary axis after **M94**. The control then reduces the display of this axis only.

If you entered a traverse limit or a software limit switch is active, **M94** is ineffective for the corresponding axis.

### Example: Reduce the display of all active rotary axes

```
L M94
```

### Example: Reduce the display of the C axis

```
L M94 C
```

### Example: Reduce the display of all active rotary axes and then move the tool in the C axis to the programmed value

```
L C+180 FMAX M94
```

### Effect

**M94** is effective only in the NC block where it is programmed.

**M94** becomes effective at the start of the block.

## Maintaining the position of the tool tip when positioning with tilted axes (TCPM): M128 (option 9)

### Standard behavior

If the inclination angle of the tool changes this results in an offset of the tool tip compared to the nominal position. The control does not compensate this offset. If the operator does not take this deviation into account in the NC program, offset machining is executed.

### Behavior with M128 (TCPM: Tool Center Point Management)

If the position of a controlled tilted axis changes in the program, the position of the tool tip in relation to the workpiece remains the same during the tilting process.

### NOTICE

#### Danger of collision!

Rotary axes with Hirth coupling must move out of the coupling to enable tilting. There is a danger of collision while the axis moves out of the coupling and during the tilting operation.

- ▶ Tool retracted before the position of the tilting axis is changed

After **M128**, you can program a feed rate at which the control will carry out the compensation movements in the linear axes.

If you want to change the position of the tilting axis with the handwheel during the program run, use **M128** along with **M118**. Superimposing handwheel positioning is implemented with active **M128**, depending on the setting in the 3D-ROT menu of the **Manual operation** operating mode, in the active coordinate system or in the non-tilted coordinate system.



#### Programming notes:

- Before positioning axes with **M91** or **M92** and before a **TOOL CALL** block, reset the **M128** function
- To avoid contour damage, you must use only spherical cutters with **M128**.
- The tool length must refer to the spherical center of the tool tip.
- If **M128** is active, the control shows the **TCPM** symbol in the status display

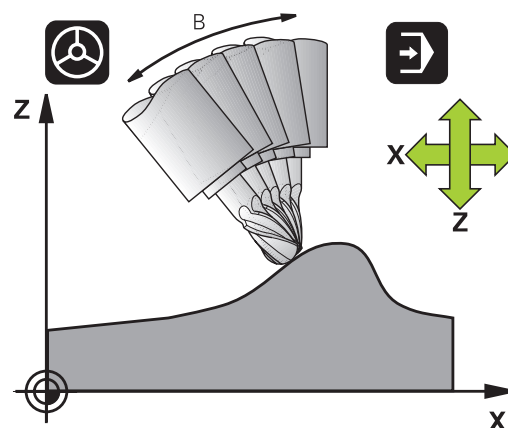



**M128 on tilting tables**

If you program a tilting table movement while **M128** is active, the control rotates the coordinate system accordingly. For example, if you rotate the C axis by 90 (through a positioning command or datum shift) and then program a movement in the X axis, the control executes the movement in the machine Y axis.

The control also transforms the preset, which has been shifted by the movement of the rotary table.

**M128 with 3-D tool compensation**

If you carry out a three-dimensional tool compensation while **M128** and an **RL/RR/** radius compensation are active, the control will position the rotary axes automatically with particular machine geometries (Peripheral Milling).

**Further information:** "Three-dimensional tool compensation (option 9)", page 579

**Effect**

**M128** becomes effective at the start of the block, **M129** at the end of the block. **M128** is also effective in the manual operating modes and remains active even after a change of mode. The feed rate for the compensation movement will be effective until you program a new feed rate or until you cancel **M128** with **M129**.

Enter **M129** to cancel **M128**. The control will also cancel **M128** if you select a new program in a program run operating mode.

**Example: Feed rate of 1000 mm/min for compensation movements**

```
L X+0 Y+38.5 IB-15 RL F125 M128 F1000
```

### Inclined machining with noncontrolled rotary axes

If your machine has non-controlled rotary axes (so-called counter axes), then you can also perform inclined machining operations with these axes in combination with **M128**.

- 1 Manually traverse the rotary axes to the desired positions. **M128** must not be active during this operation
- 2 Activate **M128**: The control reads the actual values of all existing rotary axes, calculates from this the new position of the tool center point, and updates the position display
- 3 The control performs the necessary compensating movement in the next positioning block
- 4 Carry out the machining operation
- 5 At the end of the program, cancel **M128** with **M129**, and return the rotary axes to their initial positions

Proceed as follows:



As long as **M128** is active, the control monitors the actual positions of the non-controlled rotary axes. If the actual position deviates from the nominal position by a value greater than that defined by the machine tool builder, the control outputs an error message and interrupts program run.

## Selecting tilting axes: M138

### Standard behavior

The control performs **M128**, **TCPM** and **Tilt working plane** only for those axes that the machine tool builder has specified in the machine parameters.

### Behavior with M138

The control performs the above functions only in those tilting axes that you have defined using **M138**.



Refer to your machine manual.

If you restrict the number of tilting axes with the **M138** function, your machine may provide only limited tilting possibilities. The machine tool builder will decide whether the control takes the angles of deselected axes into account or sets them to 0.

### Effect

**M138** becomes effective at the start of the block.

You can cancel **M138** by reprogramming it without specifying any axes.

### Example

Perform the above-mentioned functions only in the tilting axis C.

```
L Z+100 R0 FMAX M138 C
```

## Compensating the machine kinematics in ACTUAL/ NOMINAL positions at end of block: M144 (option 9)

### Standard behavior

If the kinematics change, e.g. by inserting a spindle attachment or entering an inclination angle, the control does not compensate this modification. If the operator does not take this modification to the kinematics into account in the NC program, offset machining is executed.

### Behavior with M144



Refer to your machine manual.

The machine geometry must be specified by the machine tool builder in the description of kinematics.

The **M144** function enables the control to consider the modification to the machine kinematics in the position display and compensate the offset of the tool tip in relation to the workpiece.



Programming and operating notes:

- Positioning blocks with **M91** or **M92** are permitted while **M144** is active.
- The position display in the **Program Run Full Sequence** and **Program Run Single Block** operating modes does not change until the tilting axes have reached their final position.

### Effect

**M144** becomes effective at the start of the block. **M144** does not work in connection with **M128** or the Tilt Working Plane function.

You can cancel **M144** by programming **M145**.

## 13.5 FUNCTION TCPM (option 9)

### Function



Refer to your machine manual.  
The machine geometry must be specified by the machine tool builder in the description of kinematics.

**FUNCTION TCPM** is an improvement on the **M128** function, with which you can define the behavior of the control when positioning the rotary axes. In contrast to **M128**, with the **FUNCTION TCPM** you can define the effect of various functions yourself:

- Effect of the programmed feed rate: **F TCP** / **F CONT**
- Interpretation of the rotary axis coordinates programmed in the NC program: **AXIS POS** / **AXIS SPAT**
- Type of interpolation between start and target position: **PATHCTRL AXIS** / **PATHCTRL VECTOR**
- Optional selection of a tool reference point and a center of rotation: **REFPNT TIP-TIP** / **REFPNT TIP-CENTER** / **REFPNT CENTER-CENTER**

If **FUNCTION TCPM** is active, the control shows the **TCPM** symbol in the position display.

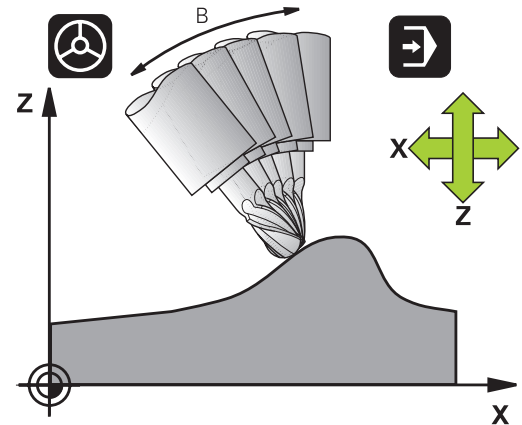

### NOTICE

#### Danger of collision!

Rotary axes with Hirth coupling must move out of the coupling to enable tilting. There is a danger of collision while the axis moves out of the coupling and during the tilting operation.

- ▶ Tool retracted before the position of the tilting axis is changed



Programming notes:

- Before positioning axes with **M91** or **M92** and before a **TOOL CALL** block, cancel the **FUNCTION TCPM** function.
- Only use spherical cutters for face milling operations in order to avoid contour damage. In combination with other tool shapes, you should use graphic simulation to test the NC program for possible contour damages.

### Defining FUNCTION TCPM

SPEC  
FCT

- ▶ Select the special functions

PROGRAM  
FUNCTIONS

- ▶ Select the programming aids

FUNCTION  
TCPM

- ▶ Select **FUNCTION TCPM**

### Mode of action of the programmed feed rate

The control provides two functions for defining the operating method of the programmed feed rate:

- F  
TCP

▶ **F TCP** determines that the programmed feed rate is interpreted as the actual relative velocity between the tool tip (**tool center point**) and the workpiece
- F  
CONTOUR

▶ **F CONT** determines that the programmed feed rate is interpreted as the contouring feed rate of the axes programmed in the respective NC block.

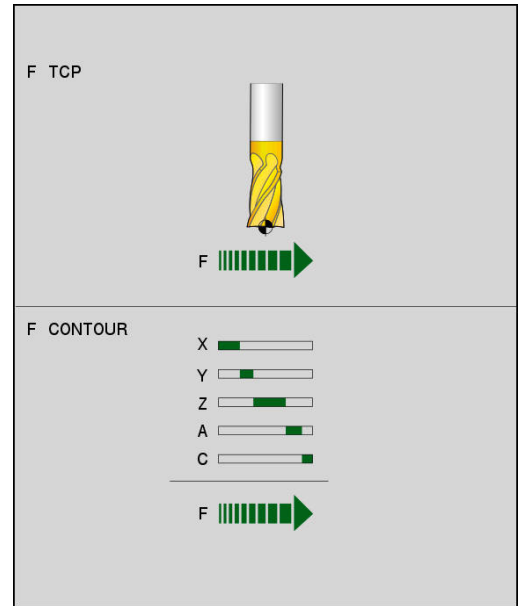

### Example

...	
13 FUNCTION TCPM F TCP ...	Feed rate refers to the tool tip
14 FUNCTION TCPM F CONT ...	Feed rate is interpreted as the speed of the tool along the contour
...	

### Interpretation of the programmed rotary axis coordinates

Up to now, machines with 45° swivel heads or 45° tilting tables could not easily set the angle of inclination or a tool orientation with respect to the currently active coordinate system (spatial angle). This function could only be realized through specially written programs with normal vectors (LN blocks).

The control now provides the following function:

- AXIS POSITION

▶ **AXIS POS** determines that the control interprets the programmed coordinates of rotary axes as the nominal position of the respective axis
- AXIS SPATIAL

▶ **AXIS SPAT** determines that the control interprets the programmed coordinates of rotary axes as spatial angles

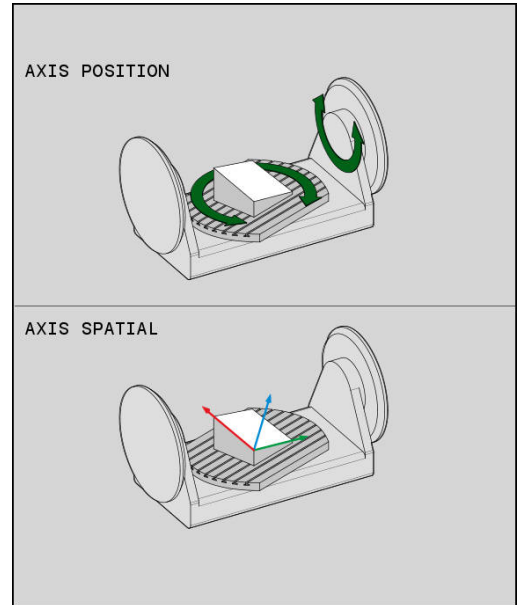

Programming notes:

- **AXIS POS** is particularly suitable in conjunction with perpendicular rotary axes. Only if the programmed rotary axis coordinates define the working plane correctly (e.g. programmed using a CAM system), you can also use **AXIS POS** with different machine concepts (e.g. 45° swivel heads).
- The **AXIS SPAT** function is used to define spatial angles that are given with respect to the active coordinate system (which might be tilted). The defined angles have the effect of incremental spatial angles. Always program all three spatial angles in the first positioning block after the **AXIS SPAT** function, even if they are 0°.

### Example

...	
13 FUNCTION TCPM F TCP AXIS POS ...	Rotary axis coordinates are axis angles
...	
18 FUNCTION TCPM F TCP AXIS SPAT ...	Rotary axis coordinates are spatial angles
20 L A+0 B+45 C+0 F MAX	Set tool orientation to B+45 degrees (spatial angle). Define space angle A and C with 0
...	

### Type of interpolation between the starting and end position

The control provides two functions for defining the type of interpolation between the starting and end position:

PATH CONTROL AXIS

- ▶ **PATHCTRL AXIS** determines that the tool tip moves on a straight line between the starting and end position of the respective NC block (**Face Milling**). The direction of the tool axis at the starting and end positions corresponds to the respective programmed values, but the tool circumference does not describe a defined path between the starting and end positions. The surface produced by milling with the tool circumference (**Peripheral Milling**) depends on the machine geometry

PATH CONTROL VECTOR

- ▶ **PATHCTRL VECTOR** determines that the tool tip moves on a straight line between the starting and end position of the respective NC block and that the direction of the tool axis is interpolated between the starting and the end position so that a plane results from machining (**Peripheral Milling**)

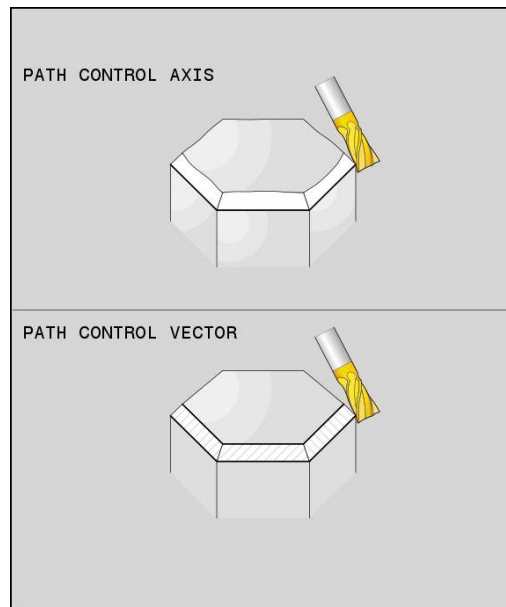

To obtain the most continuous multi-axis movement possible, define Cycle 32 with a **tolerance for rotary axes**.

The tolerances of the rotary axes and the path deviation should have the same magnitude. The greater the tolerance for the rotary axes is defined, the greater the contour deviations during peripheral milling.

**Further information:** Cycle Programming User's Manual

#### Example

...	
13 FUNCTION TCPM F TCP AXIS SPAT PATHCTRL AXIS	Tool tip moves along a straight line
14 FUNCTION TCPM F TCP AXIS POS PATHCTRL VECTOR	Tool tip and tool directional vector move in one plane
...	



## Selection of tool reference point and center of rotation

The control provides the following functions for defining the tool reference point and center of rotation:

- |                      |                                                                                                                                                                                  |
|----------------------|----------------------------------------------------------------------------------------------------------------------------------------------------------------------------------|
| REF POINT<br>TIP-TIP | ▶ <b>REFPNT TIP-TIP</b> references the (theoretical) tool tip for positioning. The center of rotation is also located at the tool tip                                            |
| REF POINT<br>TIP-CNT | ▶ <b>REFPNT TIP-CENTER</b> references the tool tip for positioning. The center of rotation is located at the center of the cutting-edge radius.                                  |
| REF POINT<br>CNT-CNT | ▶ <b>REFPNT CENTER-CENTER</b> references the center of the cutting-edge radius for positioning. The center of rotation is also located at the center of the cutting-edge radius. |

The reference point is optional. If you do not enter anything, the control uses **REFPNT TIP-TIP**.

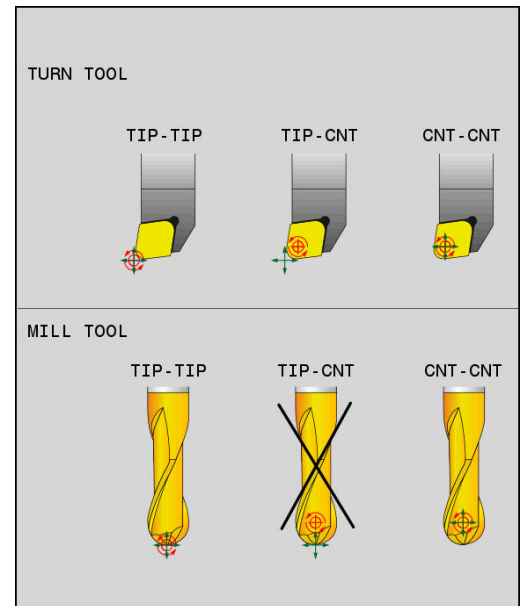

### REFPNT TIP-TIP

The **REFPNT TIP-TIP** variant corresponds to the default behavior of **FUNCTION TCPM**. You can use all previously allowed cycles and functions.

### REFPNT TIP-CENTER

The **REFPNT TIP-CENTER** variant is mainly intended for the use with turning tools. In this case the center of rotation and the positioning point are not coincident. In an NC block, the center of rotation (center of the cutting-edge radius) is kept in position, but at the end of the block, the tool tip will no longer be in its initial position.

The main goal of selecting this reference point is to enable machining of complex contours in turning mode with active radius compensation and simultaneously inclined tilting axes (simultaneous turning). The use of this function only makes sense for control in turning mode (Option 50). Currently, this software option is only supported on the TNC 640.

**REFPNT CENTER-CENTER**

You can use the **REFPNT CENTER-CENTER** variant to machine parts with a tool whose tip is used as a reference point when executing NC programs generated in a CAD/CAM software where the paths reference the center of the cutting edge radius instead of the tool tip.

Previously, this functionality could only be achieved by shortening the tool with **DL**. The variant with **REFPNT CENTER-CENTER** is advantageous in that the control knows the true tool length .

If you use **REFPNT CENTER-CENTER**, to program pocket milling cycles, the control generates an error message.

**Example**

...	
13 FUNCTION TCPM F TCP AXIS SPAT PATHCTRL AXIS REFPNT TIP-TIP	Both the tool reference point and the center of rotation are located at the tool tip.
14 FUNCTION TCPM F TCP AXIS POS PATHCTRL AXIS REFPNT CENTER-CENTER	Both the tool reference point and the center of rotation are located at the center of the cutting-edge radius.
...	

**Resetting FUNCTION TCPM**

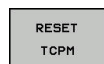

- ▶ Use **FUNCTION RESET TCPM** to explicitly cancel the function within a program.



When you select a new NC program in the **Program run, single block** or **Program run, full sequence** operating modes, the control automatically cancels the **TCPM** function.

**Example**

...	
25 FUNCTION RESET TCPM	Reset FUNCTION TCPM
...	

## 13.6 Three-dimensional tool compensation (option 9)

### Introduction

The control can perform a three-dimensional tool compensation (3-D compensation) for straight line blocks. Apart from the X, Y and Z coordinates of the straight-line end point, these blocks must also contain the components NX, NY and NZ of the surface-normal vector.

**Further information:** "Definition of a normalized vector", page 581

If you want to carry out a tool orientation, these blocks also require a normalized vector with the components TX, TY and TZ that determines the tool orientation,

**Further information:** "Definition of a normalized vector", page 581

The straight-line end point, the components for the surface normals as well as those for the tool orientation must be calculated by a CAM system.

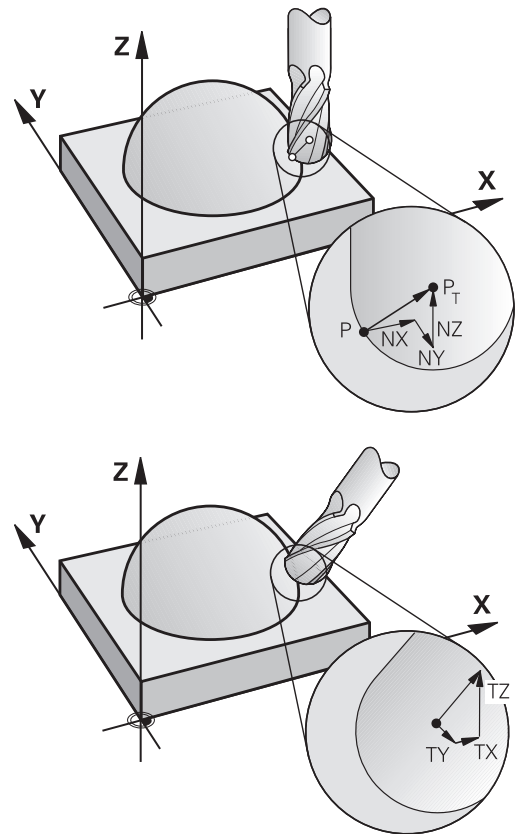

### Possible applications

- Use of tools with dimensions that do not correspond with the dimensions calculated by the CAM system (3-D compensation without definition of the tool orientation).
- Face milling: compensation of the cutter geometry in the direction of the surface-normal vector (3-D compensation with and without definition of the tool orientation). Cutting is usually with the end face of the tool.
- Peripheral milling: compensation of the cutter radius perpendicular to the direction of movement and perpendicular to the tool direction (3D radius compensation with definition of the tool orientation). Cutting is usually with the lateral surface of the tool.

## Suppressing error messages with positive tool oversize: M107

### Standard behavior

With positive tool compensation, programmed contours may be damaged. The control checks whether critical oversizes are created due to tool compensation, and if so, outputs an error message.

With Peripheral Milling the control triggers an error message in the following case:

- $DR_{Tab} + DR_{Prog} > 0$

With Face Milling the control triggers an error message in the following case:

- $DR_{Tab} + DR_{Prog} > 0$
- $R2 + DR2_{Tab} + DR2_{Prog} > R + DR_{Tab} + DR_{Prog}$
- $R2 + DR2_{Tab} + DR2_{Prog} < 0$
- $DR2_{Tab} + DR2_{Prog} > 0$

### Behavior with M107

With M107 the control suppresses the error message.

### Effect

M107 takes effect at the end of block.

You can reset M107 with M108.

## Definition of a normalized vector

A normalized vector is a mathematical quantity with a value of 1 and any direction. The control requires up to two normalized vectors for LN blocks, one to determine the direction of the surface-normal vector, and another (optional) to determine the direction of the tool orientation. The direction of a surface-normal vector is determined by the components NX, NY and NZ. For end mills and spherical cutters, it points from the workpiece surface in perpendicular direction to the tool reference point  $P_T$ , for toroid cutters, it goes through  $P_T'$  or  $P_T$  (see figure). The direction of tool orientation is determined by the components TX, TY and TZ.



### Programming notes:

- In the NC syntax, the order must be X, Y, Z for the position and NX, NY, NZ as well as TX, TY, TZ for the vectors.
- Always indicate all coordinates and all surface-normal vectors in the NC syntax for an LN block, even though the values have not changed from the previous block.
- Calculate the normal vectors as exactly as possible and specify them with a sufficient number of decimal places (recommended: at least 7), in order to avoid drastic feed rate decreases during machining. LN blocks are always calculated with a high accuracy, regardless of the setting of Option 23.
- The 3-D tool compensation using surface normal vectors is effective for the coordinate data specified for the main axes X, Y, Z.
- If you load a tool with oversize (positive delta value), the control generates an error message. You can suppress the error message with the **M107** function.
- The control will not warn you if there is a danger of contour damage due to tool oversizes.

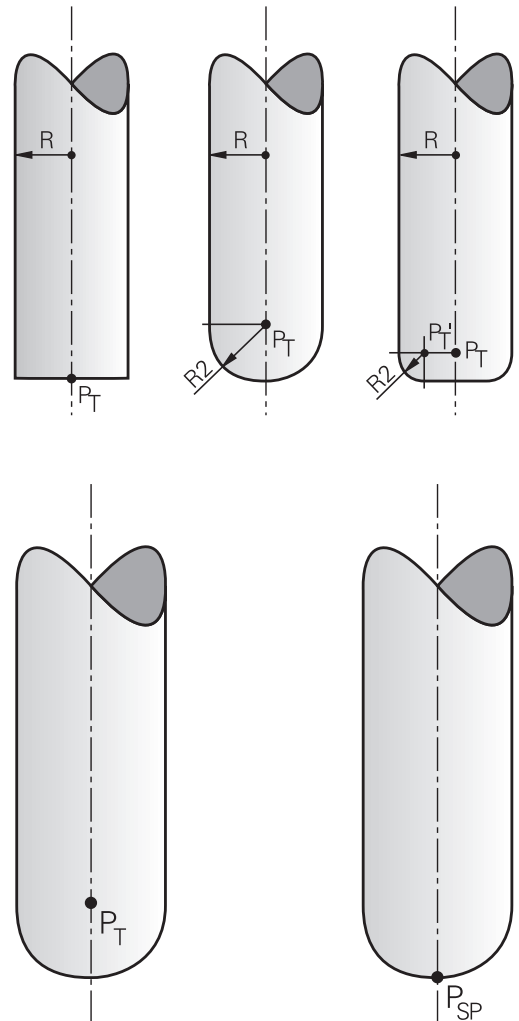

## Permissible tool shapes

You can describe the permissible tool shapes in the tool table via tool radii **R** and **R2**:

- Tool radius **R**: Distance from the tool center to the tool circumference
- Tool radius 2 **R2**: Radius of the curvature between the tool tip and tool circumference

The value of **R2** generally determines the shape of the tool:

- **R2** = 0: End mill
- **R2** > 0: toroid cutter (**R2** = **R**: spherical cutter)

These data also provide the coordinates of the tool reference point PT.

## Using other tools: Delta values

If you want to use tools that have different dimensions than the ones you originally programmed, you can enter the difference between the tool lengths and radii as delta values in the tool table or **TOOL CALL**:

- Positive delta value **DL**, **DR**: The tool is larger than the original tool (oversize)
- Negative delta value **DL**, **DR**: The tool is smaller than the original tool (undersize)

The control then compensates the tool position by the total of the delta values from the tool table and the tool call.

With **DR 2** you modify the rounding radius of the tool and therefore also the tool shape.

If you work with **DR 2** the following applies:

- $R2 + DR2_{Tab} + DR2_{Prog} = \text{End mill}$
- $0 < R2 + DR2_{Tab} + DR2_{Prog} < R$ : Toroid cutter
- $R2 + DR2_{Tab} + DR2_{Prog} = R$ : Radius cutter

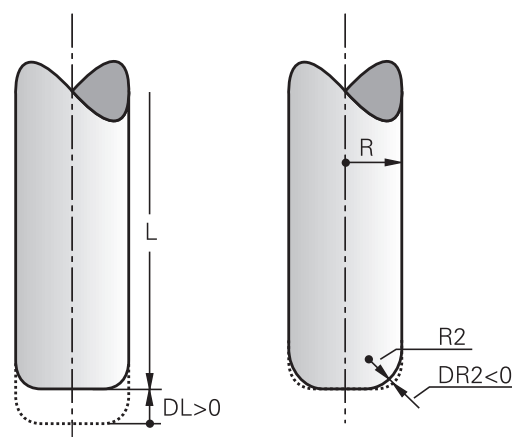

### 3-D compensation without TCPM

If the NC program includes surface normal vectors, the control performs a 3-D compensation for three-axis machining. In this case, the **RL/RR** radius compensation and **TCPM** or **M128** must be inactive. The control displaces the tool in the direction of the surface-normal vectors by the total of the delta values (from the tool table and **TOOL CALL**).



The control generally uses the defined **delta values** for 3-D tool compensation. The entire tool radius **R + DR** is only taken into account if you have activated the **FUNCTION PROG PATH IS CONTOUR** function.

**Further information:** "Interpretation of the programmed path", page 588

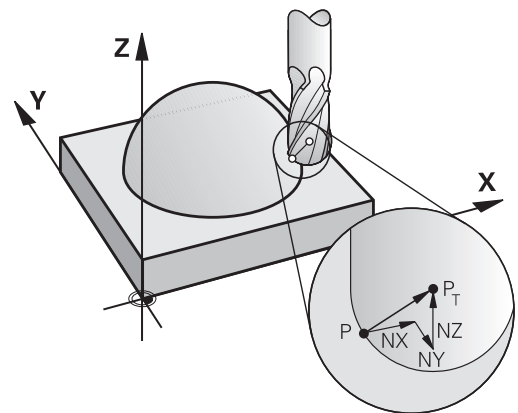

#### Example: Block format with surface-normal vectors

```
1 LN X+31.737 Y+21.954 Z+33.165NX+0.2637581 NY+0.0078922
  NZ-0.8764339 F1000 M3
```

<b>LN:</b>	Straight line with 3-D compensation
<b>X, Y, Z:</b>	Compensated coordinates of the straight-line end point
<b>NX, NY, NZ:</b>	Components of the surface-normal vector
<b>F:</b>	Feed rate
<b>M:</b>	Miscellaneous function

## Face Milling: 3D compensation with TCPM

Face milling is a machining operation carried out with the front face of the tool. If the NC program contains surface-normal vectors and **TCPM** or **M128** is active, 3-D compensation is executed with 5-axis machining. Radius compensation RL/RR must not be active in this case. The control displaces the tool in the direction of the surface-normal vectors by the total of the delta values (from the tool table and **TOOL CALL**).



The control generally uses the defined **delta values** for 3-D tool compensation. The entire tool radius **R + DR** is only taken into account if you have activated the **FUNCTION PROG PATH IS CONTOUR** function.

**Further information:** "Interpretation of the programmed path", page 588

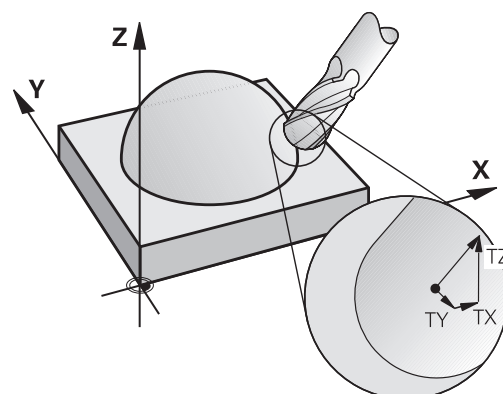

If no tool orientation was defined in the **LN** block and **TCPM** is active, the control maintains the tool perpendicular to the workpiece contour.

**Further information:** "Maintaining the position of the tool tip when positioning with tilted axes (TCPM): M128 (option 9)", page 568

If a tool orientation **T** has been defined in the **LN** block and M128 (or **FUNCTION TCPM**) is active at the same time, then the control will position the rotary axes automatically in such a way that the tool can reach the specified tool orientation. If you have not activated **M128** (or **TCPM FUNCTION**), then the control ignores the direction vector **T**, even if it is defined in the **LN** block.



Refer to your machine manual.

The control is not able to automatically position the rotary axes on all machines.

## NOTICE

### Danger of collision!

The rotary axes of a machine may have limited ranges of traverse, e.g. between  $-90^\circ$  and  $+10^\circ$  for the B head axis. Changing the tilt angle to a value of more than  $+10^\circ$  may result in a  $180^\circ$  rotation of the table axis. There is a danger of collision during the tilting movement!

- ▶ Program a safe tool position before the tilting movement, if necessary.
- ▶ Carefully test the NC program or program section in the **Program run, single block** operating mode



**Example: Block format with surface normals without tool orientation**

```
LN X+31.737 Y+21.954 Z+33.165 NX+0.2637581 NY+0.0078922 NZ-
0.8764339 F1000 M128
```

**Example: Block format with surface normals and tool orientation**

```
LN X+31.737 Y+21.954 Z+33.165 NX+0.2637581 NY+0.0078922
NZ-0.8764339 TX+0.0078922 TY-0.8764339 TZ+0.2590319
F1000 M128
```

<b>LN:</b>	Straight line with 3-D compensation
<b>X, Y, Z:</b>	Compensated coordinates of the straight-line end point
<b>NX, NY, NZ:</b>	Components of the surface-normal vector
<b>TX, TY, TZ:</b>	Components of the normalized vector for workpiece orientation
<b>F:</b>	Feed rate
<b>M:</b>	Miscellaneous function

### Peripheral milling: 3-D radius compensation with TCPM and radius compensation (RL/RR)

The control displaces the tool perpendicular to the direction of movement and perpendicular to the tool direction by the total of the **DR** delta values (from the tool table and the **TOOL CALL**). Determine the compensation direction with radius compensation **RL/RR** (see figure, traverse direction Y+). For the control to be able to reach the specified tool orientation, you need to activate the **M128** function.

**Further information:** "Maintaining the position of the tool tip when positioning with tilted axes (TCPM): M128 (option 9)", page 568

The control then positions the rotary axes automatically in such a way that the tool can reach the specified tool orientation with the active compensation.

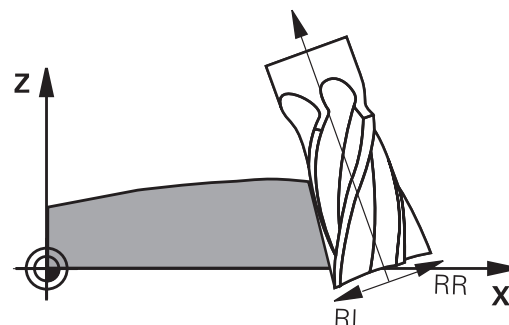

Refer to your machine manual.

This function exclusively only available with spatial angles. Your machine tool builder defines how these can be entered.

The control is not able to automatically position the rotary axes on all machines.



The control generally uses the defined **delta values** for 3-D tool compensation. The entire tool radius **R + DR** is only taken into account if you have activated the **FUNCTION PROG PATH IS CONTOUR** function.

**Further information:** "Interpretation of the programmed path", page 588

## NOTICE

### Danger of collision!

The rotary axes of a machine may have limited ranges of traverse, e.g. between  $-90^\circ$  and  $+10^\circ$  for the B head axis. Changing the tilt angle to a value of more than  $+10^\circ$  may result in a  $180^\circ$  rotation of the table axis. There is a danger of collision during the tilting movement!

- ▶ Program a safe tool position before the tilting movement, if necessary.
- ▶ Carefully test the NC program or program section in the **Program run, single block** operating mode

There are two ways to define the tool orientation:

- In an LN block with the components TX, TY and TZ
- In an L block by indicating the coordinates of the rotary axes

**Example: Block format with tool orientation**

```
1 LN X+31.737 Y+21.954 Z+33.165 TX+0.0078922 TY-0.8764339 TZ
+0.2590319 RR F1000 M128
```

<b>LN:</b>	Straight line with 3-D compensation
<b>X, Y, Z:</b>	Compensated coordinates of the straight-line end point
<b>TX, TY, TZ:</b>	Components of the normalized vector for workpiece orientation
<b>RR:</b>	Tool radius compensation
<b>F:</b>	Feed rate
<b>M:</b>	Miscellaneous function

**Example: Block format with rotary axes**

```
1 L X+31.737 Y+21.954 Z+33.165 B+12.357 C+5.896 RL F1000
M128
```



<b>L:</b>	Straight line
<b>X, Y, Z:</b>	Compensated coordinates of the straight-line end point
<b>B, C:</b>	Coordinates of the rotary axes for tool orientation
<b>RL:</b>	Radius Compensation
<b>F:</b>	Feed rate
<b>M:</b>	Miscellaneous function

## Interpretation of the programmed path



With the **FUNCTION PROG PATH** function, you decide whether the control will apply the 3-D radius compensation only to the delta values, just as before, or rather to the entire tool radius. If you activate **FUNCTION PROG PATH**, the programmed coordinates exactly correspond to the contour coordinates. With **FUNCTION PROG PATH OFF**, you deactivate this special interpretation.

### Procedure

Proceed as follows for the definition:

-  ▶ Show the soft-key row with special functions
-  ▶ Press the **PROGRAM FUNCTIONS** soft key
-  ▶ Press the **FUNCTION PROG PATH** soft key

You have the following possibilities:

Soft key	Function
	<p>Activate the interpretation of the programmed path as the contour</p> <p>The control takes the full tool radius <b>R + DR</b> and the full corner radius <b>R2 + DR2</b> into account for 3-D radius compensation.</p>
	<p>Deactivate the special interpretation of the programmed path</p> <p>The control only uses the delta values <b>DR</b> and <b>DR2</b> for 3-D radius compensation.</p>

If you activate **FUNCTION PROG PATH**, the interpretation of the programmed path as the contour is effective for 3-D compensation movements until you deactivate the function.

## 13.7 Running CAM programs

If you create NC programs externally using a CAM system, you should pay attention to the recommendations detailed below. This will enable you to optimally use the powerful motion control functionality provided by the control and usually create better workpiece surfaces with shorter machining times. Despite high machining speeds, the control still achieves a very high contour accuracy. The basis for this is the real-time operating system HeROS 5 in conjunction with the **ADP** (Advanced Dynamic Prediction) function of the TNC 620. This enables the control to also efficiently process NC programs with high point densities.

### From 3-D model to NC program

Here is a simplified description of the process for creating an NC program from a CAD model:

- ▶ **CAD: Model creation**  
Construction departments prepare a 3-D model of the workpiece to be machined. Ideally the 3-D model is designed for the center of tolerance.
- ▶ **CAM: Path generation, tool compensation**  
The CAM programmer specifies the machining strategies for the areas of the workpiece to be machined. The CAM system uses the surfaces of the CAD model to calculate the paths of the tool movements. These tool paths consist of individual points calculated by the CAM system so that each surface to be machined is approximated as nearly as possible while considering chord errors and tolerances. This way, a machine-neutral NC program is created, known as a CLDATA file (cutter location data). A post processor generates a machine- and control-specific NC program, which can be processed by the CNC control. The post processor is adapted according to the machine tool and the control. The post processor is the link between the CAM system and the CNC control.
- ▶ **Control: Motion control, tolerance monitoring, velocity profile**  
The control uses the points defined in the NC program to calculate the movements of each machine axis as well as the required velocity profiles. Powerful filter functions then process and smooth the contour so that the control does not exceed the maximum permissible path deviation.
- ▶ **Mechatronics: Feed control, drive technology, machine tool**  
The motions and velocity profiles calculated by the control are realized as actual tool movements by the machine's drive system.

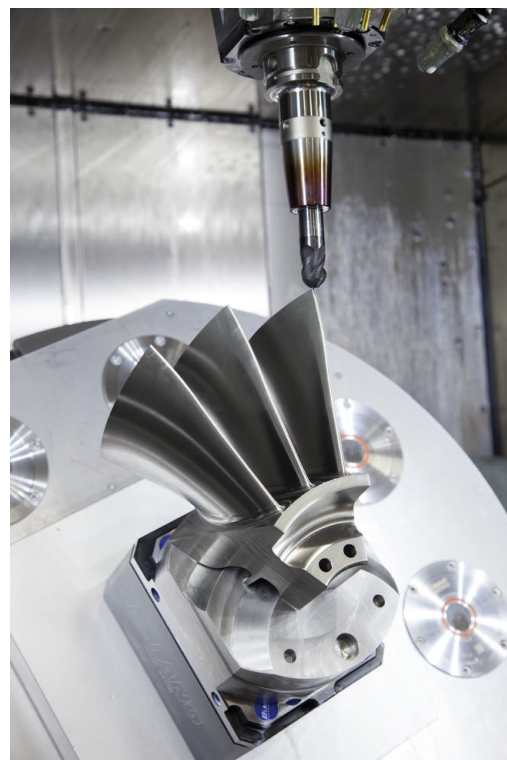

## Consider with post processor configuration

### Take the following points into account with post processor configuration:

- Always set the data output for axis positions to at least four decimal places. This way you improve the quality of the NC data and avoid rounding errors, which can result in defects visible to the naked eye on the workpiece surface. Output to five decimal places (option 23) may achieve improved surface quality for optical components and components with very large radii (i.e. small curvatures), for example forms for the automotive industry.
- Always set the data output for the machining of surface normal vectors (LN blocks, only Klartext conversational programming) to a precision of seven decimal places, as LN blocks are always calculated with a high accuracy, regardless of the setting of Option 23.
- Set the tolerance in Cycle 32 so that in standard behavior it is at least twice as large as the chord error defined in the CAM system. Also note the information in the functional description for Cycle 32.
- If the chord error selected in the CAM program is too large, then, depending on the respective curvature of a contour, large distances between NC blocks can result, each with large changes of direction. During machining this leads to drops in the feed rate at the block transitions. Recurring and equal accelerations (i.e. force excitation), caused by feed-rate drops in the heterogeneous NC program, can lead to undesirable excitation of vibrations in the machine structure.
- You can also use arc blocks instead of linear blocks to connect the path points calculated by the CAM system. The control internally calculates circles more accurately than can be defined via the input format
- Do not output any intermediate points on exactly straight lines. Intermediate points that are not exactly on a straight line can result in defects visible to the naked eye on the workpiece surface
- There should be exactly one NC data point at curvature transitions (corners)
- Avoid sequences of many short block paths. Short paths between blocks are generated in the CAM system when there are large curvature transitions with very small chord errors in effect. Exactly straight lines do not require such short block paths, which are often forced by the continuous output of points from the CAM system
- Avoid a perfectly even distribution of points over surfaces with a uniform curvature, since this could result in patterns on the workpiece surface
- For 5-axis simultaneous programs: avoid the duplicated output of positions if they only differ in the tool's angle of inclination
- Avoid the output of the feed rate in every NC block. This would negatively influence the control's velocity profile

**Useful configurations for the machine tool operator:**

- In order to improve the structure of large NC programs, use the control's structuring function  
**Further information:** "Structuring programs", page 205
- Use the control's commenting function in order to document NC programs  
**Further information:** "Adding comments", page 201
- When the machining of drill holes and simple pocket geometries, use the comprehensive cycles available in the control: See the Cycle Programming User's Manual
- For fits, output the contours with **RL/RR** tool radius compensation. This makes it easy for the machine operator to make necessary compensations  
**Further information:** "Tool compensation", page 256
- Separate feed rates for pre-positioning, machining, and downfeeds, and define them via Q parameters at the beginning of the program

**Example: Variable feed rate definitions**

1 Q50 = 7500 ; POSITION FEED RATE
2 Q51 = 750 ; FEED RATE FOR PLUNGING
3 Q52 = 1350 ; FEED RATE FOR MILLING
...
25 L Z+250 R0 FMAX
26 L X+235 Y-25 FQ50
27 L Z+35
28 L Z+33.2571 FQ51
29 L X+321.7562 Y-24.9573 Z+33.3978 FQ52
30 L X+320.8251 Y-24.4338 Z+33.8311
...

## Please note the following for CAM programming

### Adapting chord errors



Programming notes:

- For finishing operations, do not set the chord error in the CAM system to a value greater than 5  $\mu\text{m}$ . In Cycle 32, use an appropriate tolerance factor **T** of 1.3 to 5.
- For roughing operations, the total of the chord error and the tolerance **T** must be less than the defined machining oversize. This avoids contour damage.

Adapt the chord error in the CAM program, depending on the machining:

#### ■ Roughing with preference for speed:

Use higher values for the chord error and the matching tolerance value in Cycle 32. Both values depend on the oversize required on the contour. If a special cycle is available on your machine, use the roughing mode. In roughing mode the machine generally moves with high jerk values and high accelerations

- Normal tolerance in Cycle 32: Between 0.05 mm and 0.3 mm
- Normal chord error in the CAM system: Between 0.004 mm and 0.030 mm

#### ■ Finishing with preference for high accuracy:

Use smaller values for the chord error and an matching low tolerance in Cycle 32 The data density must be high enough for the control to detect transitions and corners exactly. If a special cycle is available on your machine, use the finishing mode. In finishing mode the machine generally moves with low jerk values and low accelerations

- Normal tolerance in Cycle 32: Between 0.002 mm and 0.006 mm
- Normal chord error in the CAM system: Between 0.001 mm and 0.004 mm

#### ■ Finishing with preference for high surface quality:

Use small values for the chord error and a matching larger tolerance in Cycle 32 The control is then able to better smooth the contour. If a special cycle is available on your machine, use the finishing mode. In finishing mode the machine generally moves with low jerk values and low accelerations

- Normal tolerance in Cycle 32: Between 0.010 mm and 0.020 mm
- Normal chord error in the CAM system: Smaller than 0.005 mm

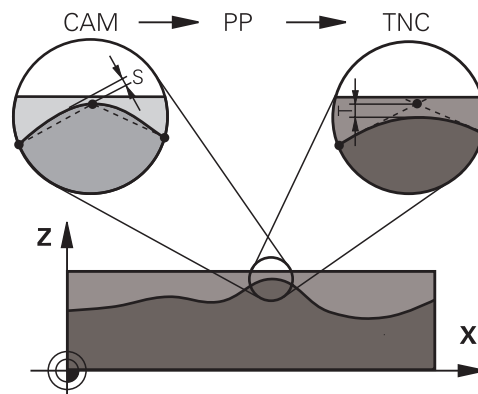



### Further adaptations

Take the following points into account with CAM programming:

- For slow machining feed rates or contours with large radii, define the chord error to be only one-third to one-fifth of tolerance **T** in Cycle 32. Additionally, define the maximum permissible point spacing to be between 0.25 mm and 0.5 mm. The geometry error or model error should also be specified to be very small (max. 1 µm).
- Even at higher machining feed rates, point spacings of greater than 2.5 mm are not recommended for curved contour areas
- For straight contour elements, one NC point at the beginning of a line and one NC point at the end suffice. Avoid the output of intermediate positions
- In programs with five axes moving simultaneously, avoid large changes in the ratio of path lengths in linear and rotational blocks. Otherwise large reductions in the feed rate could result at the tool reference point (TCP)
- The feed-rate limitation for compensating movements (e.g. via **M128 F...**) should be used only in exceptional cases. The feed-rate limitation for compensating movements can cause large reductions in the feed rate at the tool reference point (TCP).
- NC programs for 5-axis simultaneous machining with spherical cutters should preferably be output for the center of the sphere. The NC data are then generally more consistent. Additionally, in Cycle 32 you can set a higher rotational axis tolerance **TA** (e.g. between 1° and 3°) for an even more constant feed-rate curve at the tool reference point (TCP).
- For NC programs for 5-axis simultaneous machining with toroid cutters or radius cutters where the NC output is for the south pole of the sphere, choose a lower rotational axis tolerance. 0.1° is a typical value. However, the maximum permissible contour damage is the decisive factor for the rotational axis tolerance. This contour damage depends on the possible tool tilting, tool radius and contact depth of the tool.

With 5-axis gear hobbing with an end mill you can calculate the maximum possible contour damage **T** directly from the cutter contact length **L** and permissible contour tolerance **TA**:

$$T \sim K \times L \times TA \quad K = 0.0175 [1/^\circ]$$

Example:  $L = 10 \text{ mm}$ ,  $TA = 0.1^\circ$ :  $T = 0.0175 \text{ mm}$

### Possibilities for intervention on the control

Cycle 32 **TOLERANCE** is available for influencing the behavior of CAM programs directly on the control. Please note the information in the functional description of Cycle 32. Also note the interactions with the chord error defined in the CAM system.

**Further information:** Cycle Programming User's Manual



Refer to your machine manual.

Some machine tool builders provide an additional cycle for adapting the behavior of the machine to the respective machining operation, such as Cycle 332 Tuning. Cycle 332 can be used to modify filter settings, acceleration settings, and jerk settings.

### Example

```
34 CYCL DEF 32.0 TOLERANCE
```

```
35 CYCL DEF 32.1 T0.05
```

```
36 CYCL DEF 32.2 HSC MODE:1 TA3
```

## ADP motion control



This feature must be enabled and adapted by the machine tool builder.

An insufficient quality of data in NC programs created on CAM systems frequently causes inferior surface quality of the milled workpieces. The **ADP** (Advanced Dynamic Prediction) feature expands the conventional look-ahead of the permissible maximum feed rate profile and optimizes the motion control of the feed axes during milling. This enables clean surfaces with short machining times to be cut, even with a strongly fluctuating distribution of points in adjacent tool paths. This significantly reduces or eliminates the reworking complexity.

These are the most important benefits of ADP:

- Symmetrical feed-rate behavior on forward and backward paths with bidirectional milling
- Uniform feed rate curves with adjacent cutter paths
- Improved reaction to negative effects (e.g. short, step-like stages, coarse chord tolerances, heavily rounded block end-point coordinates) in NC programs generated by CAM system
- Precise compliance to dynamic characteristics even in difficult conditions



14

**Pallet Management**

## 14.1 Pallet management (option number 22)

### Application



Refer to your machine manual.

Pallet table management is a machine-dependent function. The standard functional range is described below.

Pallet tables (.p) are mainly used in machining centers with pallet changers. The pallet tables call the different pallets (PAL), fixtures (FIX) optionally, and the associated NC programs (PGM). The pallet tables activate all defined presets and datum tables.

Without a pallet changer you can use pallet tables to process NC programs with different presets in sequence with just one press of **NC Start**.



The file name of a pallet table must always begin with a letter.

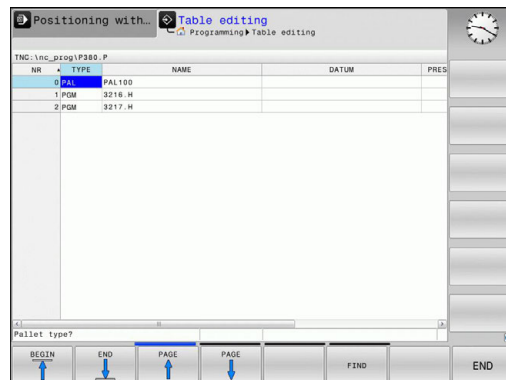

### Columns of the pallet table

The machine tool builder defines a pallet table prototype that opens automatically when you create a pallet table.

The prototype can include the following columns:

Column	Meaning	Field type
<b>NR</b>	The control creates the entry automatically. The entry is required for the entry field <b>Line number =</b> of the <b>BLOCK SCAN</b> function.	Mandatory field
<b>TYPE</b>	The control differentiates between the following entries <ul style="list-style-type: none"> <li>■ <b>PAL</b> Pallet</li> <li>■ <b>FIX</b> Fixture</li> <li>■ <b>PGM</b> NC program</li> </ul> Select the entries using the <b>ENT</b> key and the arrow keys or by soft key.	Mandatory field
<b>NAME</b>	File name The machine tool builder specifies the names for pallets and fixtures, if applicable, whereas you define program names. You must specify the complete path if the NC program is not saved in the directory of the pallet table.	Mandatory field
<b>DATUM</b>	Datum You must specify the complete path if the datum table is not saved in the directory of the pallet table. You activate datums from a datum table in the NC program using Cycle 7.	optional field This entry is only required if a datum table is used.
<b>PRESET</b>	Workpiece preset Enter the preset number of the workpiece.	Optional field
<b>LOCATION</b>	Location of the pallet The entry <b>MA</b> indicates that there is a pallet or fixture in the working space of the machine and can be machined. Press the <b>ENT</b> key to enter <b>MA</b> . Press the <b>NO ENT</b> key to remove the entry and thus suppress machining.	Optional field If the column exists, the entry is mandatory.
<b>LOCK</b>	Line locked Using an <b>*</b> you can exclude the line of the pallet table from processing. Press the <b>ENT</b> key to identify the line with the entry <b>*</b> . Press the <b>NO ENT</b> key to cancel the lock. You can lock the execution for individual NC programs, fixtures or entire pallets. Unlocked lines (e.g. PGM) in a locked pallet are also not executed.	Optional field
<b>PALPRES</b>	Number of the pallet preset	Optional field This entry is only required if pallet presets are used.
<b>W-STATUS</b>	Execution status	Optional field This entry is only required for tool-oriented machining.

Column	Meaning	Field type
METHOD	Machining method	Optional field This entry is only required for tool-oriented machining.
CTID	ID for mid-program startup	Optional field This entry is only required for tool-oriented machining.
SP-X, SP-Y, SP-Z	Clearance height in the linear axes X, Y, and Z	Optional field
SP-A, SP-B, SP-C	Clearance height in the rotary axes A, B, and C	Optional field
SP-U, SP-V, SP-W	Clearance height in the parallel axes U, V, and W	Optional field
DOC	Comment	Optional field













You can remove the **LOCATION** column if you are only using pallet tables in which the control is to machine all lines.







**Further information:** "Inserting or deleting columns", page 602

### Editing a pallet table

When you create a new pallet table, it is empty at first. Using the soft keys, you can insert and edit lines.

Soft key	Editing function
	Select the table start
	Select the table end
	Select the previous page in the table
	Select the next page in the table
	Insert as last line in the table
	Delete the last line in the table
	Add several lines at end of table
	Copy the current value
	Insert the copied value
	Select beginning of line





Soft key	Editing function
	Select end of line
	Find text or value
	Sort or hide table columns
	Edit the current field
	Sort by column contents
	Miscellaneous functions, e.g. saving
	Open file path selection

## Selecting pallet table

You can select or create a pallet table as follows:

-  ▶ Switch to the **Programming** mode or a program run mode
-  ▶ Press the **PGM MGT** key

If no pallet tables are visible:

-  ▶ Press the **SELECT TYPE** soft key
-  ▶ Press the **SHOW ALL** soft key
-  ▶ Press the **ENT** key



You can select either a list view or form view using the **Screen Layout** key.





## Inserting or deleting columns



This function is not enabled until the code number **555343** is entered.

Depending on the configuration, a newly created pallet table may not contain all columns. For tool-oriented working, for example, you need columns that you have to insert first.

Proceed as follows to insert a column in an empty pallet table:

- ▶ Open the pallet table
  -  ▶ Press the **MORE FUNCTIONS** soft key
  -  ▶ Press the **EDIT FORMAT** soft key
  - ▶ The control opens a pop-up window displaying the available columns
  - ▶ Using the arrow keys, select the desired column.
  -  ▶ Press the **INSERT COLUMN** soft key
  -  ▶ Press the **ENT** key

You can remove the column with the **DELETE COLUMN** soft key.

## Processing pallet table



A machine parameter defines whether the control is to execute the pallet table blockwise or continuously.

You can execute a pallet table as follows:



- ▶ Switch to **Program run, full sequence** or **Program run, single block** operating mode



- ▶ Press the **PGM MGT** key

If no pallet tables are visible:



- ▶ Press the **SELECT TYPE** soft key
- ▶ Press the **SHOW ALL** soft key
- ▶ Select a pallet table with the arrow keys



- ▶ Press the **ENT** key



- ▶ Select the screen layout, if necessary



- ▶ Execute with the **NC Start** key

To check the NC program content before execution, proceed as follows:

- ▶ Select pallet table
- ▶ With the arrow keys, choose the NC program you would like to check

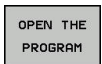

- ▶ Press the **OPEN THE PROGRAM** soft key
- ▶ The control displays the selected NC program on the screen.



- ▶ Scroll through the NC program with the arrow keys

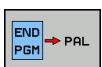

- ▶ Press the **END PGM PAL** soft key
- ▶ The control returns to the pallet table.



A machine parameter defines how the control is to react after an error.

### Screen layout when working in the pallet table

If you want to see the NC program content and the content of the pallet table at the same time, select the screen layout **PALLET + PROGRAM**. During execution, the control then shows NC program blocks to the left and the pallet to the right.

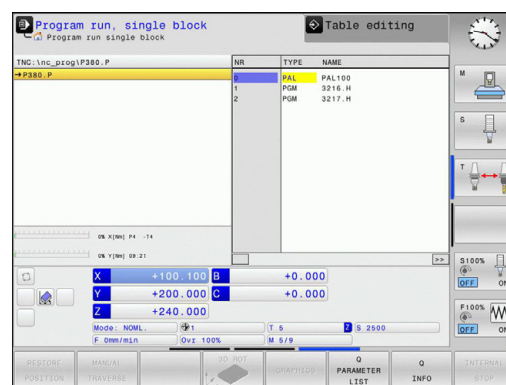
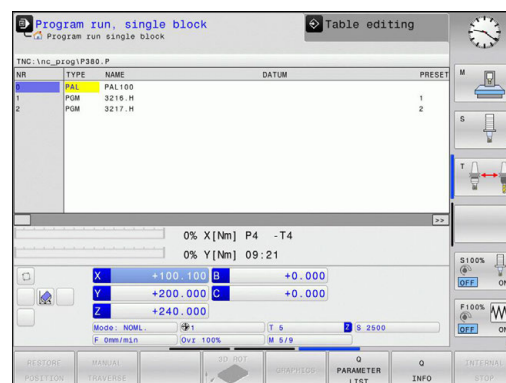

### Editing pallet tables

If the pallet table is active in the **Program run, full sequence** or **Program run, single block** operating mode, the soft keys for modifying the table in the **Programming** operating mode are inactive.

You can modify this table with the **EDIT PALLET** soft key in the **Program run, single block** or **Program run, full sequence** operating mode.

### Block scan in a pallet table

With the pallet management you can also use the **BLOCK SCAN** function in conjunction with pallet tables.

If you interrupt the processing of pallet tables, the control always suggests the previously selected NC block of the interrupted NC program for the **BLOCK SCAN** function.

**Further information:** "Block scan in pallet programs", page 732

## 14.2 Pallet preset management

### Fundamentals



Refer to your machine manual.

This feature must be enabled and adapted by the machine tool builder.

Changes to the pallet preset table must always be made in agreement with your machine tool builder!

The pallet preset table is available to you in addition to the workpiece preset table (**preset.pr**). The workpiece presets refer to an activated pallet preset.

The control shows the active pallet preset in the status display on the PAL tab.

### Application

Pallet presets are an easy way to compensate e.g. mechanical differences between individual pallets.

You can also completely align the coordinate system to the pallet by e.g. positioning the pallet preset in the center of a clamping tower.

### Using pallet presets

If you want to use pallet presets, insert the **PALPRES** column in the pallet table.

Enter the preset number from the pallet preset table into this column. Usually, you always want to change the pallet preset when you insert a new pallet, i.e. in the PAL type lines of the pallet table.

### NOTICE

#### Danger of collision!

Despite a basic rotation due to the active pallet preset, the control does not show a symbol in the status display. There is a danger of collision during all subsequent axis movements!

- ▶ If necessary, check the active pallet preset in the **PAL** tab
- ▶ Check the traverse movements of the machine
- ▶ Use pallet presets only in conjunction with pallets

## 14.3 Tool-oriented machining

### Fundamentals

#### Application



Refer to your machine manual.

Tool-oriented machining is a machine-dependent function. The standard functional range is described below.

Tool-oriented machining allows you to machine several workpieces together even on a machine without pallet changer, which reduces tool-change times.

#### Limitation

### NOTICE

#### Danger of collision!

Not all pallet tables and NC programs are suitable for tool-oriented machining. With tool-oriented machining, the control no longer executes the NC programs continuously, but divides them at the tool calls. The division of the NC programs allows functions that were not reset to be effective across programs (machine states). This leads to a danger of collision during machining!

- ▶ Consider the stated limitations
- ▶ Adapt pallet tables and NC programs to the tool-oriented machining
  - Reprogram the program information after each tool in every NC program (e.g. **M3** or **M4**).
  - Reset special functions and miscellaneous functions before each tool in every NC program (e. g. **Tilt the working plane** or **M138**)
- ▶ Carefully test the pallet table and associated NC programs in the **Program run, single block** operating mode

The following functions are not permitted:

- FUNCTION TCPM, M128
- M144
- M101
- M118
- Changing the pallet preset

The following functions require special attention, particularly for mid-program startup:

- Changing the machine statuses with a miscellaneous function (e.g. M13)
- Writing to the configuration (e.g. WRITE KINEMATICS)
- Traverse range switchover
- Cycle 32 Tolerance
- Tilting the working plane

**Pallet table columns for tool-oriented machining**

Unless the machine tool builder has made a different configuration, you need the following additional columns for tool-oriented machining:

Column	Meaning
<b>W-STATUS</b>	<p>The machining status defines the machining progress. Enter BLANK for an unmachined (raw) workpiece. The control changes this entry automatically during machining.</p> <p>The control differentiates between the following entries</p> <ul style="list-style-type: none"> <li>■ BLANK: Workpiece blank, requires machining</li> <li>■ INCOMPLETE: Partly machined, requires further machining</li> <li>■ ENDED: Machined completely, no further machining required</li> <li>■ EMPTY: Empty space, no machining required</li> <li>■ SKIP: Skip machining</li> </ul>
<b>METHOD</b>	<p>Indicates the machining method</p> <p>Tool-oriented machining is also possible with a combination of pallet fixtures, but not for multiple pallets.</p> <p>The control differentiates between the following entries</p> <ul style="list-style-type: none"> <li>■ WPO: Workpiece oriented (standard)</li> <li>■ TO: Tool oriented (first workpiece)</li> <li>■ CTO: Tool oriented (further workpieces)</li> </ul>
<b>CTID</b>	<p>The control automatically generates the ID number for mid-program startup with block scan. If you delete or change the entry, mid-program startup is no longer possible.</p>
<b>SP-X, SP-Y, SP-Z, SP-A, SP-B, SP-C, SP-U, SP-V, SP-W</b>	<p>The entry for the clearance height in the existing axes is optional.</p> <p>You can enter safety positions for the axes. The control only approaches these positions if the machine tool builder processes them in the NC macros.</p>

## Sequence of tool-oriented machining

### Requirements

Requirements for tool-oriented machining:

- The machine manufacturer must define a tool-change macro for tool-oriented machining
- The tool-oriented machining methods TO and CTO have to be defined in the pallet table
- The NC programs are using the same tools to at least some extent
- The W-STATUS of the NC programs permits further machining

### Sequence

- 1 The entry TO or CTO tells the control that the tool-oriented machining is valid beyond these lines of the pallet table
- 2 The control executes the NC program with the entry TO up to the TOOL CALL
- 3 The W-STATUS changes from BLANK to INCOMPLETE and the control enters a value into the CTID field
- 4 The control executes all other NC programs with the entry CTO up to the TOOL CALL
- 5 The control uses the next tool for the following machining steps if one of the following situations applies:
  - The next line in the table contains the entry PAL
  - The next line in the table contains the entry TO or WPO
  - There are lines in the table that do not yet contain the entry ENDED or EMPTY
- 6 The control updates the entry in the CTID field with each machining operation
- 7 If all table lines of the group contain the entry ENDED, the control processes the next few lines in the pallet table

### Resetting the machining status

If you want to start machining again, change the W-STATUS to BLANK.

If you change the status in the PAL line, all FIX and PGM lines below this line are automatically changed, too.



### Mid-program startup with block scan

You can also return to a pallet table after an interruption. The control can show the line and the NC block at which the interruption occurred.

The block scan in the pallet table is tool oriented.

After the mid-program startup, the control can resume tool-oriented machining if the tool-oriented machining method TO and CTO is defined in the following lines.

#### Keep the following in mind for mid-program startup

- The entry in the CTID field remains there for two weeks. After this time, mid-programs startup is no longer possible.
- Do not change or delete the entry in the CTID field.
- The data from the CTID field become invalid after a software update.
- The control saves the preset numbers for mid-program startup. If you change this preset, machining is shifted, too.
- Mid-program startup is no longer possible after editing an NC program within tool-oriented machining.

The following functions require special attention, particularly for mid-program startup:

- Changing the machine statuses with a miscellaneous function (e.g. M13)
- Writing to the configuration (e.g. WRITE KINEMATICS)
- Traverse range switchover
- Cycle 32 Tolerance
- Tilting the working plane



# 15

**Batch Process  
Manager**

## 15.1 Batch Process Manager (option 154)

### Fundamentals

#### Screen display

When you open the **Batch Process Manager**, the following screen layout is displayed:

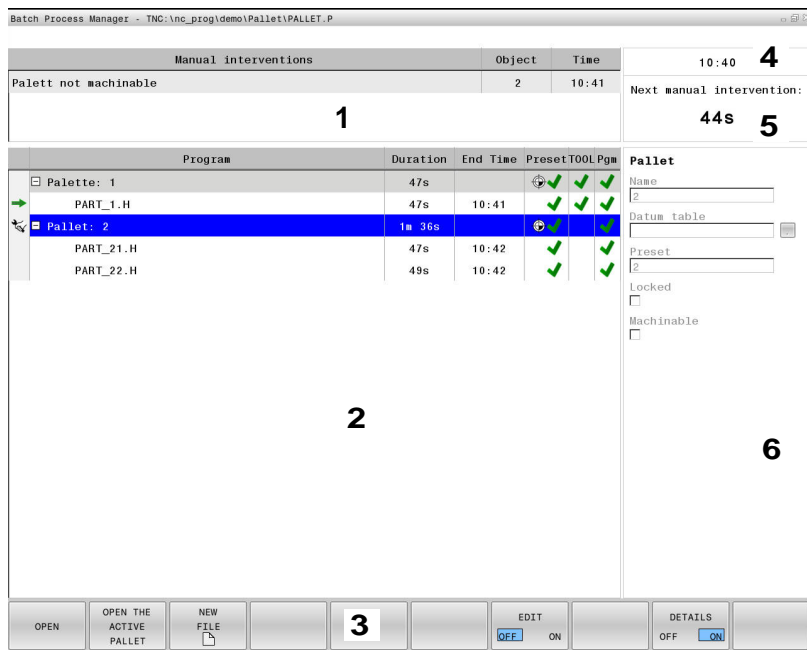

- 1 Displays all required manual interventions
- 2 Displays the selected job list
- 3 Displays the current soft keys
- 4 Displays the current time
- 5 Displays the next manual intervention
- 6 Shows the editable entries in the line highlighted in blue

### Application

The **Batch Process Manager** enables you to plan production orders on a machine tool.

You save the planned NC programs in a job list. The job list is opened on the third desktop with the **Batch Process Manager**.

The following information is displayed:

- Whether the NC program is free of errors
- Run time of the NC programs
- Availability of the tools
- Times at which manual interventions in the machine are required



The tool usage test function has to be enabled and switched on to ensure you get all information!



**Further information:** "Tool usage test", page 254

**Columns of the job list**

Column	Meaning
No column name	Status of the <b>Pallet, Fixture</b> or <b>Program</b>
<b>Program</b>	Name or path of the <b>Pallet, Fixture</b> or <b>Program</b>
<b>Duration</b>	Run time
<b>End Time</b>	End of the run time
<b>Preset</b>	Status of the workpiece preset
<b>TOOL</b>	Status of the inserted tools
<b>Pgm</b>	Status of the program
<b>Status</b>	Execution status







The status of the **Pallet, Fixture** and **Program** is shown by means of icons in the first column.

The icons have the following meanings:

Icon	Meaning
	<b>Pallet, Fixture</b> or <b>Program</b> is locked
	<b>Pallet</b> or <b>Fixture</b> is not enabled for machining
	This line is currently being processed in <b>Program run, single block</b> or <b>Program run, full sequence</b> and cannot be edited

The status is indicated by icons in the **Preset**, **TOOL** and **Pgm** columns.

The icons have the following meanings:

Icon	Meaning
	Test completed
	Test failed, e.g. because of expired tool life
	Test not yet completed
	Incorrect program structure, e.g.: pallet does not contain subordinate programs
	Workpiece preset is defined
	Check input You can either assign a workpiece preset to the pallet or to all subordinate programs.











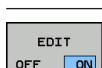
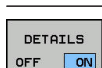
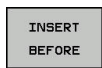

If the tool usage test function on your machine is not enabled or switched on, no icon is shown in the **Pgm** column.

**Further information:** "Tool usage test", page 254

The **Status** column is only visible if you are using tool-oriented machining.

When you open the **Batch Process Manager**, the following soft keys are available:

Soft key	Function
	Open job list
	If a job list is opened in <b>Program run, single block</b> or <b>Program run, full sequence</b> , it is also opened in the <b>Batch Process Manager</b>
	Create new job list
	Edit opened job list
	Collapse or expand tree structure
<b>INSERT REMOVE</b>	Shows the soft keys <b>INSERT BEFORE</b> , <b>INSERT AFTER</b> and <b>REMOVE</b>
	Insert a new <b>Pallet</b> , <b>Fixture</b> or <b>Program</b> before the cursor position

Soft key	Function
	Insert a new <b>Pallet, Fixture</b> or <b>Program</b> after the cursor position
	Delete line or block
	Switch active windows
	Move line
	Reset status
	Select possible entries from a pop-up window
	Select line
	Cancel marking

## Opening the Batch Process Manager

You can open the **Batch Process Manager** in the following way:



- ▶ Press the **Batch Process Manager** key
- > The control opens the **Batch Process Manager**.

## Creating a job list

There are two ways to create a job list:

- In the pallet management
  - Further information:** "Pallet Management", page 597
  - The control opens the pallet table (.p) in the **Batch Process Manager** as a job list.
- Directly in the **Batch Process Manager**



The file name of a job list must always begin with a letter.

Create a job list in the **Batch Process Manager** as follows:



- ▶ Press the **Batch Process Manager** key
- > The control opens the **Batch Process Manager**.



- ▶ Press the **NEW FILE** soft key
- > The control opens the **Create Pallet File ...** pop-up window.
- ▶ Enter the target directory and any desired file name in the pop-up window



- ▶ Press the **ENT** key
- > The control opens an empty job list.
- ▶ As an alternative, press **Save**



- ▶ Press the **INSERT REMOVE** soft key
- ▶ Press the **INSERT AFTER** soft key
- > The control displays the various types on the right-hand side.
- ▶ Select the desired type
  - **Pallet**
  - **Fixture**
  - **Program**
- > The control inserts an empty line in the job list.
- > The control shows the selected type on the right-hand side.
- ▶ Define the entries
  - **Name:** Enter the name directly or select one by means of the pop-up window, if there is one
  - **Datum table:** Enter the datum directly, if required, or select one by means of the pop-up window
  - **Preset:** Enter the workpiece preset directly, if required
  - **Locked:** Lock the selected line
  - **Editing possible:** The selected line cannot be edited



- ▶ Confirm your entries by pressing the **ENT** key.

- ▶ Repeat the steps if required



- ▶ Press the **EDIT** soft key



## Editing a job list

There are two ways to create a job list:

- In the pallet management

**Further information:** "Editing pallet tables", page 604

The control opens the pallet table (.p) in the **Batch Process Manager** as a job list.

- Directly in the **Batch Process Manager**

You can edit a line in the job list in the **Batch Process Manager** as follows:

- ▶ Open the desired job list

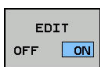

- ▶ Press the **EDIT** soft key



- ▶ Place the cursor on the desired line, e.g. **Pallet**
- > The control displays the selected line in blue.
- > The control displays the editable entries on the right-hand side.



- ▶ Press the **CHANGE WINDOW** soft key if required
- > The control switches the active window.
- ▶ The following entries can be changed:

- **Name**
- **Datum table**
- **Preset**
- **Locked**
- **Editing possible**



- ▶ Confirm the edited entries by pressing the **ENT** key.
- > The control adopts the changes.



- ▶ Press the **EDIT** soft key

In the **Batch Process Manager** you can move a line in the job list as follows:

- ▶ Open the desired job list

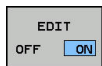

- ▶ Press the **EDIT** soft key



- ▶ Place the cursor on the desired line, e.g. **Program**
- > The control displays the selected line in blue.

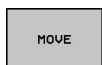

- ▶ Press the **MOVE** soft key



- ▶ Press the **TAG** soft key
- > The control highlights the line in which the cursor is positioned.



- ▶ Place the cursor on the desired position.
- > When the cursor is placed at a suitable position, the control shows the **INSERT BEFORE** and **INSERT AFTER** soft keys.

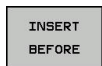

- ▶ Press the **INSERT BEFORE** soft key
- > The control inserts the line at the new position.



- ▶ Press the **GO BACK** soft key



- ▶ Press the **EDIT** soft key

## Executing the job list

You can execute the job list using the pallet management

**Further information:** "Processing pallet table", page 603

The control opens the job list as a pallet table in the pallet management (.p).

# 16

**Manual Operation  
and Setup**

## 16.1 Switch-on, switch-off

### Switch-on

#### DANGER

##### Caution: Danger for the operator!

Machines and machine components always present mechanical hazards. Electric, magnetic or electromagnetic fields are particularly hazardous for persons with cardiac pacemakers or implants. The hazard starts when the machine is powered up!

- ▶ Read and follow the machine manual
- ▶ Read and follow the safety precautions and safety symbols
- ▶ Use the safety devices



Refer to your machine manual.

Switching on the machine and traversing the reference points can vary depending on the machine tool.

Switch the machine and the control on as follows:

- ▶ Switch on the power supply for the control and the machine
- > The control displays the switch-on status in the subsequent dialogs.
- > If booting was successful, the control displays the **Power interrupted** dialog

**CE**

- ▶ Press the **CE** key to clear the message
- > The control displays the **Compiling PLC program** dialog; the PLC program is compiled automatically
- > The control displays the **Switch on external dc voltage** dialog

**I**

- ▶ Switch on the machine control voltage
- > The control carries out a self-test.

If the control does not register an error, it displays the **Traverse reference points** dialog.

If the control registers an error, it issues an error message.

**Check the axis positions**

This section applies only to machine axes with EnDat encoders.

If the actual axis position after the machine is switched on does not match the position at switch-off, the control displays a pop-up window.

- ▶ Check the axis position of the affected axis
- ▶ If the current axis position matches that proposed in the display, confirm with **YES**

**NOTICE****Danger of collision!**

If they are not paid attention to, deviations between the actual axis positions and those expected by the control (saved at the time of switch-off) can lead to undesirable and unforeseeable movements of the axes. There is risk of collision during referencing and all subsequent movements.

- ▶ Check the axis positions
- ▶ Only confirm the pop-up window with **YES** if the axis positions match
- ▶ Despite confirmation, at first only move the axis carefully
- ▶ If there are discrepancies or you have any doubts, contact your machine tool builder

## Traverse reference points

If the control performs the self-test successfully, it then displays the **Traverse reference points** dialog.



Refer to your machine manual.

Switching on the machine and traversing the reference points can vary depending on the machine tool.

If your machine is equipped with absolute encoders, you can leave out crossing the reference points.



If you intend only to edit or graphically simulate NC programs, you can select the **Programming** or **Test Run** mode of operation immediately after switching on the control voltage, without needing to reference the axes.

You can neither set a preset nor modify a preset via the preset table without having referenced the axes. The control issues the **Traverse reference points** hint.

You can cross the reference points later. For this purpose, in **Manual operation** mode press the **PASS OVER REFERENCE** soft key.

Cross the reference points manually in the displayed sequence:



- ▶ For each axis press the **NC START** button, or
- > The control is now ready for operation in the **Manual operation** mode.

As an alternative you can cross the reference points in any sequence:



- ▶ Press and hold the axis direction button for each axis until the reference point has been traversed



- > The control is now ready for operation in the **Manual operation** mode.

**Crossing the reference point in a tilted working plane**

If the **Tilt working plane** function was active before the control was switched off, then the control automatically activates the function after restarting. This means that movements via the axis keys take place in the tilted working plane.

Before traversing the reference points you must deactivate the **Tilt the working plane** function, otherwise the control interrupts the process with an error message. You can also reference axes not activated in the current kinematic model without needing to deactivate **Tilt the working plane**, such as a tool magazine.

**Further information:** "Activating manual tilting:", page 690

**NOTICE****Danger of collision!**

The control does not automatically check whether collisions can occur between the tool and the workpiece. Incorrect pre-positioning or insufficient spacing between components can lead to a risk of collision when referencing the axes.

- ▶ Pay attention to the information on the screen
- ▶ If necessary, move to a safe position before referencing the axes
- ▶ Watch out for possible collisions



If the machine does not have any absolute encoders, the position of the rotary axes must be confirmed. The position shown in the pop-up window is the last position before the control was switched off.

## Switch-off



Refer to your machine manual.  
Deactivation is a machine-dependent function.

To prevent data from being lost on switch-off, you need to shut down the operating system of the control as follows:



- ▶ Operating mode: Press the **Manual operation** key



- ▶ Press the **OFF** soft key



- ▶ Confirm with the **SHUT DOWN** soft key
- ▶ When the control displays the message **Now you can switch off** in a pop-up window, you may switch off the power supply to the control

### NOTICE

#### Caution: Data may be lost!

The control must be shut down so that running processes can be concluded and data can be saved. Immediate switch-off of the control by turning off the main switch can lead to data loss not matter what state the control was in.

- ▶ Always shut down the control
- ▶ Only turn off the main switch after being prompted on the screen



## 16.2 Moving the machine axes

### Note



Refer to your machine manual.  
Movement of the axes via the axis direction keys can vary depending on the machine.

### Moving the axis with the axis direction keys



- ▶ Operating mode: Press the **Manual operation** key



- ▶ Press the axis direction key and hold it down as long as you wish the axis to move; or



- ▶ To move the axis continuously: Press and hold the axis direction button and press the **NC Start** key



- ▶ To stop: Press the **NC Stop** key











You can move several axes at a time with these two methods. The control then shows the feed rate. You can change the feed rate at which the axes are moved with the **F** soft key.

**Further information:** "Spindle speed S, feed rate F and miscellaneous function M", page 637

If a moving task is active on the machine, the control displays the **control in operation** symbol.

## Incremental jog positioning

With incremental jog positioning you can move a machine axis by a preset distance.

- 
  - ▶ Operating mode: Press the **Manual operation** or **Electronic handwheel** key
- 
  - ▶ Shift the soft-key row
- 
  - ▶ Select incremental jog positioning: Switch the **INCREMENT** soft key to **ON**
- 
  - ▶ Enter the infeed of the **linear axes** and confirm with the **CONFIRM VALUE** soft key
- 
  - ▶ Alternatively, confirm with the **ENT** key
- 
  - ▶ Use the arrow keys to position the cursor on the **rotary axis**
- 
  - ▶ Enter the infeed of the **rotary axes** and confirm with the **CONFIRM VALUE** soft key
- 
  - ▶ Alternatively, confirm with the **ENT** key
- 
  - ▶ Confirm with the **OK** soft key
  - ▶ The increment is active.
- 
  - ▶ Deactivate incremental jog positioning: Switch the **INCREMENT** soft key to **OFF**

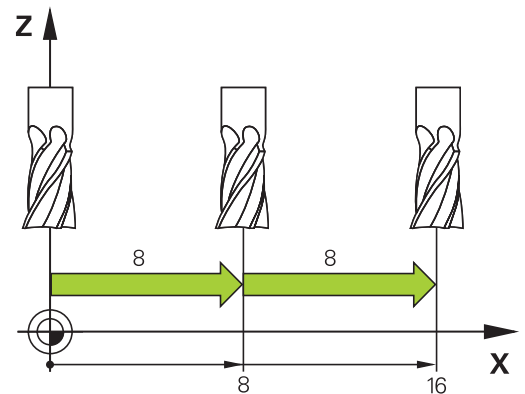

If you are in the **Jog increment** menu, you can switch off incremental jog positioning with the **SWITCH OFF** soft key.

The input range for the infeed is from 0.001 mm to 10 mm.

## Traverse with electronic handwheels

### **⚠ DANGER**

#### **Caution: Danger for the operator!**

Unsecured connections, defective cables, and improper use are always sources of electrical dangers. The hazard starts when the machine is powered up!

- ▶ Devices should be connected or removed only by authorized service technicians
- ▶ Only switch on the machine via a connected handwheel or a secured connection

The control supports traversing with the following new electronic handwheels:

- HR 510: Simple handwheel without display, data transfer via cable
- HR 520: Handwheel with display, data transfer via cable
- HR 550FS: Handwheel with display, data transfer via radio

In addition to this, the control continues to support the cable handwheels HR 410 (without display) and HR 420 (with display).



Refer to your machine manual.

Your machine tool builder can make additional functions of the HR 5xx handwheels available.



If you want to use the **Handwheel superimp.:** function in a virtual tool axis **VT**, then we recommend the handwheel HR 5xx.

**Further information:** "Virtual tool axis VT", page 482

The portable HR 520 and HR 550FS handwheels feature a display on which the control shows information. In addition, you can use the handwheel soft keys for important setup functions, e.g. presetting or entering and running M functions.

As soon as you have activated the handwheel with the handwheel activation key, the operating panel is locked. The control shows this status in a pop-up window on the screen.

If several handwheels are connected to a control the handwheel key is not available on the operating panel. Activate or deactivate the handwheel via the handwheel key on the handwheel. An active handwheel must be deactivated before another handwheel can be selected.



Refer to your machine manual.

This feature must be enabled and adapted by the machine tool builder.



- 1 **EMERGENCY STOP** key
- 2 Handwheel display for status and for selecting functions
- 3 Soft keys
- 4 Axis keys; can be exchanged by the machine manufacturer depending on the axis configuration
- 5 Permissive key
- 6 Arrow keys for defining handwheel sensitivity
- 7 Handwheel activation key
- 8 Key for traverse direction of the selected axis
- 9 Rapid traverse superimposing for the axis direction key
- 10 Spindle switch-on (machine-dependent function, key can be exchanged by the machine manufacturer)
- 11 **Generate NC block** key (machine-dependent function, key can be exchanged by the machine manufacturer)
- 12 Spindle switch-off (machine-dependent function, key can be exchanged by the machine manufacturer)
- 13 **CTRL** key for special functions (machine-specific function, key can be exchanged by the machine manufacturer)
- 14 **NC START** key (machine-dependent function, key can be exchanged by the machine manufacturer)
- 15 **NC STOP** key (machine-dependent function, key can be exchanged by the machine manufacturer)
- 16 Handwheel
- 17 Spindle speed potentiometer
- 18 Feed rate potentiometer
- 19 Cable connection, not available with the HR 550FS wireless handwheel

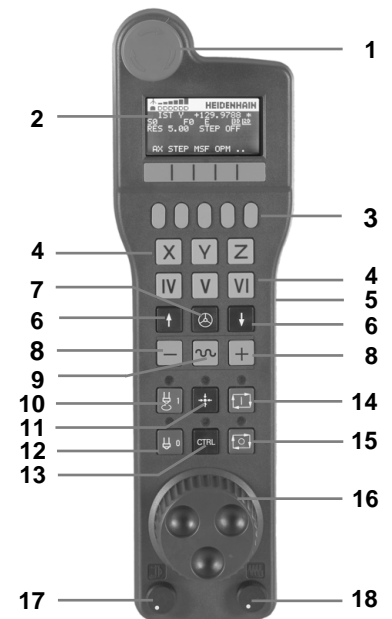

### Handwheel display

- 1 **Only with wireless handwheel HR 550FS:** Shows whether the handwheel is in the docking station or whether wireless operation is active
- 2 **Only with wireless handwheel HR 550FS:** Shows the signal strength, 6 bars = maximum signal strength
- 3 **Only with wireless handwheel HR 550FS:** Shows the charge status of the rechargeable battery, 6 bars = fully charged A bar moves from the left to the right during recharging
- 4 **ACTL:** Type of position display
- 5 **Y+129.9788:** Position of the selected axis
- 6 **\***: STIB (control in operation); program run has been started or axis is in motion
- 7 **S0:** Current spindle speed
- 8 **F0:** Feed rate at which the selected axis is moving
- 9 **E:** Error message  
If an error message appears on the control, the handwheel display shows the message **ERROR** for three seconds. Then the letter **E** is shown in the display as long as the error is pending on the control.
- 10 **3D:** Tilted-working-plane function is active
- 11 **2D:** Basic rotation function is active
- 12 **RES 5.0:** Active handwheel resolution. Path traversed by the selected axis with a handwheel revolution
- 13 **STEP ON** or **OFF:** Incremental jog active or inactive. If the function is active, the control additionally displays the current traversing step
- 14 **Soft-key row:** Selection of various functions, described in the following sections

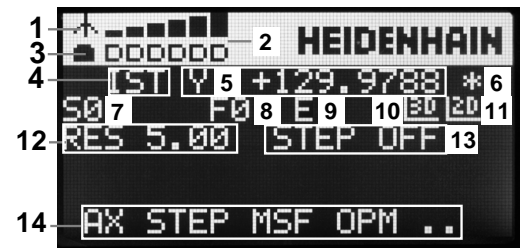

### Special features of the wireless handwheel HR 550FS

#### **⚠ DANGER**

##### **Caution: Danger for the operator!**

Wireless handwheels, due to their rechargeable batteries and the influence of other wireless devices, are more susceptible to interference than cable-bound connections are. Ignoring the requirements for and information about safe operation leads to endangerment of the user, for example during installation or maintenance work.

- ▶ Check the radio connection of the handwheel for possible overlapping with other wireless devices
- ▶ Switch off the wireless handwheel and the handwheel holder after an operating time of 120 hours at the latest so that the control can run a functional test when it is restarted
- ▶ If more than one wireless handwheel is being used in a workshop, then ensure an unambiguous assignment between the handwheels and the handwheel holders (such as with color-coded stickers)
- ▶ If more than one wireless handwheel is being used in a workshop, then ensure an unambiguous assignment between the handwheels and the respective machine (such as with a functional test)

The HR 550FS wireless handwheel features a rechargeable battery. The battery starts charging when you put the handwheel in the holder.

You can operate the HR 550FS with the battery for up to 8 hours before it must be recharged again. When the handwheel is completely discharged, it takes about 3 hours until it is fully recharged in the handwheel holder. If the HR 550 is not needed, always put it in the handwheel holder. This way you can ensure that the handwheel batteries are always ready for use thanks to the contact strip on the rear side of the wireless handwheel and the recharge control, and that there is a direct contact connection for the emergency stop circuit.

As soon as the handwheel is in its holder, it switches internally to cable operation. This means you can still use it even if the handwheel is fully discharged. The functions are the same as with wireless operation.



Clean the contacts **1** in the handwheel holder and of the handwheel regularly to ensure their proper functioning.

The transmission range is amply dimensioned. If you should nevertheless happen to come near the edge of the transmission area, which is possible with very large machines, the HR 550FS warns you in time with a plainly noticeable vibration alarm. If this happens you must reduce the distance to the handwheel holder in which the radio receiver is integrated.

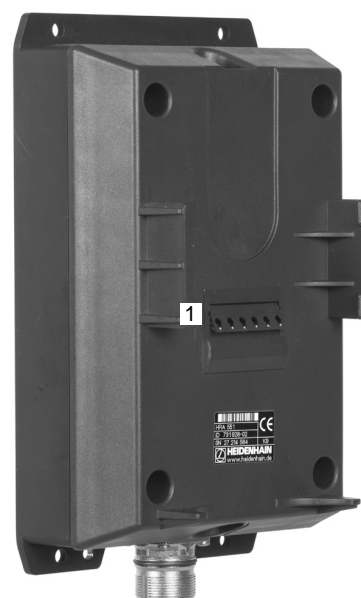

**NOTICE****Caution: Danger to the tool and workpiece!**

The wireless handwheel triggers an emergency stop reaction if the radio transmission is interrupted, the battery is fully empty, or if there is a defect. Emergency stop reactions during machining can cause damage to the tool or workpiece.

- ▶ Place the handwheel in the handwheel holder when it is not in use
- ▶ Keep the distance between the handwheel and the handwheel holder small (pay attention to the vibration alarm)
- ▶ Test the handwheel before machining

If the control has triggered an emergency stop you must reactivate the handwheel. Proceed as follows:

- ▶ Press the **MOD** key to select the MOD function
- ▶ Select **Machine settings**



- ▶ Press the **SET UP WIRELESS HANDWHEEL** soft key
- ▶ Click the **Start handwheel** button to reactivate the wireless handwheel
- ▶ To save the configuration and exit the configuration menu, press **END**

The **MOD** operating mode includes a function for commissioning and configuring the handwheel.

**Further information:** "Configuring the HR 550FS wireless handwheel", page 770

### Selecting the axis to be moved

You can activate the principal axes X, Y, Z and three other axes defined by the machine manufacturer directly through the axis keys. Your machine tool builder can also place the virtual axis VT directly on one of the free axis keys. If the virtual axis VT is not on one of the axis keys, proceed as follows:

- ▶ Press the handwheel soft key **F1 (AX)**
- > The control shows all active axes on the handwheel display. The currently active axis flashes.
- ▶ Select the desired axis with the handwheel soft keys **F1 (->)** or **F2 (<-)** and confirm with the **F3 (OK)** handwheel soft key

### Setting the handwheel sensitivity

The handwheel sensitivity determines which path an axis takes per revolution of the handwheel. The sensitivity levels are predefined and are selectable with the handwheel arrow keys (only when incremental jog is not active).

Selectable sensitivity levels:

0.001/0.002/0.005/0.01/0.02/0.05/0.1/0.2/0.5/1 [mm/revolution or degrees/revolution]

Selectable sensitivity levels:

0.00005/0.001/0.002/0.004/0.01/0.02/0.03 [in mm/revolution or degrees/revolution]

### Moving the axes



- ▶ To activate the handwheel, press the handwheel button on the HR 5xx:
- > Now you can operate the control only via the HR 5xx. The control displays a pop-up window with this information on the screen.
- ▶ Select the desired operating mode with the **OPM** soft key if necessary



- ▶ If required, press and hold the permissive button



- ▶ Use the handwheel to select the axis to be moved. Select the additional axes with the soft keys as required



- ▶ Move the active axis in the positive direction with the + key, or



- ▶ Move the active axis in the negative direction with the - key



- ▶ To deactivate the handwheel, press the handwheel key on the HR 5xx
- > Now you can operate the control via the operating panel again.



## Potentiometer settings

### DANGER

#### Caution: Danger for the operator!

Activating the handwheel does not automatically activate the potentiometers of the handwheel; rather the potentiometers on the operating panel of the control remain active. After an NC start on the handwheel, the control immediately begins with machining or with axis positioning, even though the potentiometers on the handwheel are set to 0 %. There is a risk of death to anybody inside the working space!

- ▶ Before using the handwheel, set the potentiometers of the operating panel to 0 %
- ▶ When using the handwheel, always also activate the potentiometers of the handwheel

The potentiometers of the machine operating panel continue to be active after you have activated the handwheel. If you want to use the potentiometers on the handwheel, proceed as follows:

- ▶ Press the **CTRL** and **handwheel** keys on the HR 5xx at the same time
- > The control shows the soft-key menu for selecting the potentiometers in the handwheel's display.
- ▶ Press the **HW** soft key to activate the handwheel potentiometers

If you have activated the potentiometers on the handwheel, you must reactivate the potentiometers of the machine operating panel before deselecting the handwheel. Proceed as follows:

- ▶ Press the **CTRL** and **handwheel** keys on the HR 5xx at the same time
- > The control shows the soft-key menu for selecting the potentiometers in the handwheel's display.
- ▶ Press the **KBD** soft key to activate the potentiometers of the machine operating panel

The control issues a warning if the handwheel potentiometers are still active after the handwheel has been deactivated.

### Incremental jog positioning

With incremental jog positioning the control moves the currently active handwheel axis by a preset increment defined by you:

- ▶ Press the handwheel soft key **F2 (STEP)**
- ▶ Activate incremental jog positioning: Press handwheel soft key **3 (ON)**
- ▶ Select the desired jog increment by pressing the **F1** or **F2** key. The smallest possible increment is 0.0001 mm (0.00001 inches). The largest possible increment is 10 mm (0.3937 inches).
- ▶ Confirm the selected jog increment with soft key **4 (OK)**
- ▶ With the **+** or **-** handwheel key, move the active handwheel axis in the corresponding direction



If you press and hold the **F1** or **F2** key, each time it reaches a decimal value 0 the control increases the counting increment by a factor of 10.

By also pressing the **CTRL** key, you can increase the counting increment by a factor of 100 when pressing **F1** or **F2**.

### Inputting miscellaneous functions M

- ▶ Press the **F3 (MSF)** handwheel soft key
- ▶ Press the **F1 (M)** handwheel soft key
- ▶ Select the desired M function number by pressing the **F1** or **F2** key
- ▶ Execute the M miscellaneous function with the **NC Start** key

### Entering the spindle speed S

- ▶ Press the **F3 (MSF)** handwheel soft key
- ▶ Press the **F2 (S)** handwheel soft key
- ▶ Select the desired speed by pressing the **F1** or **F2** key
- ▶ Activate the new speed S with the **NC Start** key



If you press and hold the **F1** or **F2** key, each time it reaches a decimal value 0 the control increases the counting increment by a factor of 10.

By also pressing the **CTRL** key, you can increase the counting increment by a factor of 100 when pressing **F1** or **F2**.

**Entering the feed rate F**

- ▶ Press the **F3 (MSF)** handwheel soft key
- ▶ Press the **F3 (F)** handwheel soft key
- ▶ Select the desired feed rate by pressing the **F1** or **F2** key
- ▶ Confirm the new feed rate F with the **F3 (OK)** handwheel soft key



If you press and hold the **F1** or **F2** key, each time it reaches a decimal value 0 the control increases the counting increment by a factor of 10.

By also pressing the **CTRL** key, you can increase the counting increment by a factor of 100 when pressing **F1** or **F2**.

**Presetting**

Refer to your machine manual.

The machine tool builder can disable presetting in individual axes.

- ▶ Press the **F3 (MSF)** handwheel soft key
- ▶ Press the **F4 (PRS)** handwheel soft key
- ▶ If required, select the axis in which the preset is to be set.
- ▶ Zero the axis with the handwheel soft key **F3 (OK)** or with **F1** and **F2** set the desired value and then confirm with **F3 (OK)**.  
By also pressing the **CTRL** key, you can increase the counting increment to 10

**Changing modes of operation**

With the handwheel soft key **F4 (OPM)** you can use the handwheel to switch the operating mode, provided that the current status of the control allows a mode change.

- ▶ Press the **F4 (OPM)** handwheel soft key
- ▶ Select the desired operating mode by handwheel soft key
  - MAN: **Manual operation**
  - MDI: **Positioning w/ Manual Data Input**
  - SGL: **Program run, single block**
  - RUN: **Program run, full sequence**

**Generating a complete traversing block**

Refer to your machine manual.

Your machine tool builder can assign any function to the **Generate NC block** handwheel key.

- ▶ Select the **Positioning w/ Manual Data Input** operating mode
- ▶ If required, use the arrow keys on the control's keyboard to select the NC block after which the new traversing block is to be inserted
- ▶ Activate the handwheel
- ▶ Press the **Generate NC block** key on the handwheel
- ▶ The control inserts a complete traversing block containing all axis positions selected through the MOD function.

### Features in the program run modes of operation

You can use the following functions in the Program Run modes of operation:

- The **NC Start** key (**NC Start** handwheel key)
- The **NC Stop** key (**NC Stop** handwheel key)
- After the **NC Stop** key has been pressed: Internal stop (handwheel soft keys **MOP** and then **Stop**)
- After the **NC STOP** key has been pressed: Traverse manual axes (handwheel soft keys **MOP** and then **MAN**)
- Returning to the contour after the axes were moved manually during a program interruption (**MOP** and then **REPO** handwheel soft keys). The handwheel soft keys, which function similarly to the screen soft keys, are used for operating.  
**Further information:** "Returning to the contour", page 733
- On/off switch for the Tilt working plane function (handwheel soft keys **MOP** and then **3D**)

## 16.3 Spindle speed S, feed rate F and miscellaneous function M

### Application

In the **Manual operation** and **Electronic handwheel** operating modes, you can enter the spindle speed S, feed rate F and the miscellaneous functions M with soft keys.

**Further information:** "Entering miscellaneous functions M and STOP", page 468



Refer to your machine manual.

The machine tool builder defines which additional functions are available on the machine.

### Entering values

#### Spindle speed S, miscellaneous function M



- ▶ Select input for spindle speed: press the **S** soft key

#### SPINDLE SPEED S=



- ▶ Enter **1000** (spindle speed) and apply this value with the **NC Start** key

The spindle speed with the entered speed **S** is started with a miscellaneous function **M**. Input a miscellaneous function **M** in the same way.

The control shows the current spindle speed in the status display. If the spindle speed is less than 1000, the control also shows a decimal place that has been entered.

#### Feed rate F

After entering a feed rate **F**, confirm your entry with the **ENT** key.

The following is valid for feed rate F:

- If you enter  $F=0$ , then the feed rate that the machine tool builder has defined as minimum feed rate is effective
- If the feed rate entered exceeds the maximum value that has been defined by the machine tool builder, then the value defined by the machine tool builder is effective
- F is not lost during a power interruption
- The control displays the feed rate.
  - When **3D ROT** is active the machining feed rate is shown if several axes are moved
  - If **3D ROT** is not active, the feed drive display remains empty if several axes are moved

## Adjusting spindle speed and feed rate

With the potentiometers you can vary the spindle speed S and feed rate F from 0 % to 150 % of the set value.

The feed rate potentiometer only lowers the programmed feed rate, not the feed rate calculated by the control.



The override for spindle speed is only functional on machines with infinitely variable spindle drive.



## Feed rate limit F MAX



Refer to your machine manual.  
The feed-rate limit depends on the machine.

The **F MAX** soft key enables you to reduce the feed rate speed for all operating modes. The reduction applies to all rapid traverse and feed rate movements. The value you enter remains active after switch-off or switch-on.

The **F MAX** soft key is available in the following operating modes:

- Program run, single block
- Program run, full sequence
- Positioning w/ Manual Data Input

### Procedure

To activate the feed rate limit F MAX, proceed as follows:



- ▶ Operating mode: Press the **Positioning w/ Manual Data Input** key



- ▶ Press the **F MAX** soft key



- ▶ Enter the desired maximum feed rate
- ▶ Press the OK soft key

## 16.4 Optional safety concept (functional safety FS)

### Miscellaneous



Refer to your machine manual.  
You machine tool builder adapts the HEIDENHAIN safety system to your machine.

Every machine tool operator is exposed to certain risks. Although protective devices can prevent access to dangerous points, the operator must also be able to work on the machine without this protection (e.g. protective door opened). Several guidelines and regulations to minimize these risks have been developed within the last few years.

The integrated safety design from HEIDENHAIN complies with **Performance-Level d** as per EN 13849-1 and **SIL 2** as per IEC 61508. The safety-related operating modes correspond to EN 12417 and assure extensive operator protection.

The basis of the HEIDENHAIN safety concept is the dual-channel processor structure, which consists of the main computer (MC) and one or more drive controller modules (CC= control computing unit). All monitoring mechanisms are designed redundantly in the control systems. Safety-relevant system data are subject to a mutual cyclic data comparison. Safety-relevant errors always lead to safe stopping of all drives through defined stop reactions.

Defined safety functions are triggered and safe operating statuses are achieved via safety-relevant inputs and outputs (dual-channel implementation), which have an influence on the system in all operating modes.

In this chapter you will find explanations of the functions that are additionally available on a control with functional safety.

## Explanation of terms

### Safety-related operating modes

Description	Brief description
SOM_1	Safe operating mode 1: Automatic operation, production mode
SOM_2	Safe operating mode 2: Set-up mode
SOM_3	Safe operating mode 3: Manual intervention; only for qualified operators
SOM_4	Safe operating mode 4: Advanced manual intervention, process monitoring

### Safety functions

Description	Brief description
SS0, SS1, SS1F, SS2	Safe stop: safe stopping of all drives using different methods
STO	Safe torque off: Energy supply to the motor is interrupted. Provides protection against unexpected start of the drives
SOS	Safe operating stop. Provides protection against unexpected start of the drives
SLS	Safely-limited speed. Prevents the drives from exceeding the specified speed limits when the protective door is opened





## Additional status displays





On a control with functional safety FS, the general status display contains additional information about the current status of safety functions. The control shows this information as operating statuses of the status displays **T**, **S**, and **F**.

Status display	Brief description
STO	Energy supply to the spindle or a feed drive is interrupted.
SLS	Safely limited speed: A safely limited speed is active
SOS	Safe operating stop: Safe operating stop is active.
STO	Safe torque off: Energy supply to the motor is interrupted.

The control displays an icon to show the status of the axes:

Button	Short description
	The axis has been tested
	The axis has not been tested. All axes must achieve the "tested" status. <b>Further information:</b> "Checking the axis positions", page 642

The control shows the active safety-related mode of operation with an icon in the header to the right of the operating mode text:

Icon	Safety-related operating mode
	<b>SOM_1</b> operating mode active
	<b>SOM_2</b> operating mode active
	<b>SOM_3</b> mode active
	<b>SOM_4</b> mode active

## Checking the axis positions



Refer to your machine manual.

This function must be adapted by your machine manufacturer.

After switch-on the control checks whether the position of an axis matches the position directly after switch-off. If a deviation occurs, this axis is displayed in red on the position display. Axes that are marked red can no longer be moved while the door is opened.

In such cases you must approach a test position for the axes in question. Proceed as follows:

- ▶ Select the **Manual operation** mode
- ▶ Execute the approach with **NC Start** to move the axes in the sequence shown
- > The axis moves to the test position.
- > Once the test position has been reached, a dialog appears asking whether the test position was approached correctly.
- ▶ Confirm with the **OK** soft key if the control approached the test position correctly, and with **END** if the control approached the position incorrectly
- ▶ If you confirmed with **OK**, you must confirm the correctness of the test position again with the permissive key on the machine operating panel
- ▶ Repeat this procedure for all axes that you want to move to the test position

### NOTICE

#### Danger of collision!

The control does not automatically check whether collisions can occur between the tool and the workpiece. Incorrect pre-positioning or insufficient spacing between components can lead to a risk of collision while approaching the test positions.

- ▶ If necessary, move to a safe position before approaching the test positions
- ▶ Watch out for possible collisions



Refer to your machine manual.

The location of the test position is specified by your machine tool builder.

## Activating feed-rate limitation



Refer to your machine manual.

This function must be adapted by your machine manufacturer.

With this function you can prevent the SS1 reaction (safe stopping of drives) from being triggered when the protective door is opened.

If you press the **F LIMITED** soft key, the control will limit the speed of the axes and of the spindle(s) to the values defined by the machine tool builder. The limitation depends on the safe SOM\_x operating mode selected with the aid of the keylock switch. If SOM\_1 is active, the axes and spindles are brought to a stop, because only then will you be allowed to open the guard doors in SOM\_1.



- ▶ Select the **Manual operation** mode



- ▶ Shift the soft-key row

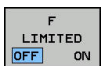

- ▶ Switch on/off feed rate limit

## 16.5 Managing presets

### Note



It is essential that you use the preset table in the following cases:

- If your machine is equipped with rotary axes (tilting table or swivel head) and you work with the **Tilt working plane** function
- If your machine is equipped with a spindle-head changing system
- If up to now you have been working with older controls with REF-based datum tables
- You wish to machine several identical workpieces that are aligned differently

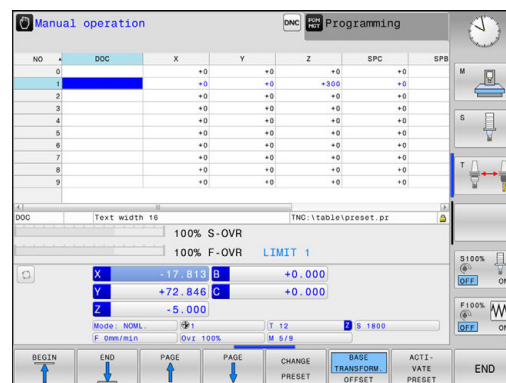

The preset table can contain any number of rows (presets). To optimize the file size and the processing speed, only use as many rows as you need to manage your presets.

For safety reasons, new rows can be inserted only at the end of the preset table.

### Presets and pallet reference points

If you work with pallets, please note that the presets stored in the preset table are relative to an activated pallet reference point.

**Further information:** "Pallet Management", page 597

### Saving presets in the table



Refer to your machine manual.

The machine tool builder can disable presetting in individual axes.

The preset table has the name **PRESET.PR**, and is saved in the **TNC:\table\** directory. **PRESET.PR** is editable in the **Manual operation** and **Electronic handwheel** modes only if the **CHANGE PRESET** soft key was pressed. You can open the **PRESET.PR** preset table in the **Programming** operating mode but not edit it.

Copying the preset table into another directory (for data backup) is permitted. Write-protected rows are also write-protected in the copied tables.

Never change the number of rows in the copied tables! If you want to reactivate the table, this may lead to problems.

To activate the preset table copied to another directory you have to copy it back to the **TNC:\table\** directory

There are several methods for saving presets and basic rotations in the preset table:

- Manual input
  - Using the probing cycles in the **Manual operation** and **Electronic handwheel** modes
  - Using probing cycles 400 to 402 and 410 to 419 in automatic mode
- Further information:** Cycle Programming User's Manual



Operating notes:

- Basic rotations from the preset table rotate the coordinate system about the preset, which is shown in the same row as the basic rotation.
- When presetting, the positions of the tilting axes must match the tilted situation.
  - If the **Tilt working plane** function is not active, the position display for the rotary axes must be = 0° (zero the rotary axes if necessary)
  - If the **Tilt working plane** function is active, the position displays for the rotary axes must match the angles entered in the 3-D ROT menu
- **PLANE RESET** does not reset the active 3-D ROT.
- In row 0 the control always saves the preset that you most recently set manually via the axis keys or via soft key. If the preset set manually is active, the control displays the text **PR MAN(0)** in the status display.

### Manually saving the presets in the preset table

Proceed as follows in order to save presets in the preset table:



- ▶ Select the **Manual operation** mode



- ▶ Move the tool slowly until it touches (scratches) the workpiece surface, or position the measuring dial correspondingly



- ▶ Press the **PRESET MANAGEMENT** soft key
- > The control opens the preset table and sets the cursor to the row of the active preset.



- ▶ Press the **CHANGE PRESET** soft key
- > The control displays all available input options in the soft-key row.



- ▶ Select the row in the preset table that you want to change (the row number is the preset number)





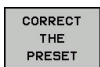



- ▶ If needed, select the column in the preset table that you want to change















- ▶ Use the soft keys to select one of the available entry possibilities

## Input options

Soft key	Function
	Directly transfer the actual position of the tool (the measuring dial) as the new preset: This function only saves the preset in the axis in which the cursor is currently hovering.
	Assign any value to the actual position of the tool (the measuring dial): This function only saves the preset in the axis in which the cursor is currently hovering. Enter the desired value in the pop-up window
	Incrementally shift a preset already stored in the table: This function only saves the preset in the axis in which the cursor is currently hovering. Enter the desired corrective value with the correct sign in the pop-up window. If inch display is active: Enter the value in inches, and the control will internally convert the entered values to mm
	Directly enter the new preset without calculation of the kinematics (axis-specific). Only use this function if your machine has a rotary table, and you want to set the preset to the center of the rotary table by entering 0. This function only saves the value in the axis in which the cursor is currently hovering. Enter the desired value in the pop-up window. If inch display is active: Enter the value in inches, and the control will internally convert the entered values to mm
	Select the <b>BASE TRANSFORM./OFFSET</b> view. The standard <b>BASE TRANSFORM.</b> view shows the X, Y and Z columns. Depending on the machine, the columns SPA, SPB, and SPC are displayed in addition. The control saves the basic rotation here (with the Z tool axis the control uses the SPC column). The <b>OFFSET</b> view shows the offset values for the preset.
	Write the currently active preset to a selectable line in the table: This function saves the preset in all axes, and then activates the appropriate row in the table automatically. If inch display is active: Enter the value in inches, and the control will internally convert the entered values to mm

### Editing the preset table

Soft key	Editing function in table mode
	Select the table start
	Select the table end
	Select the previous page in the table
	Select the next page in the table
	Select the functions for entry of presets
	Choose between showing the Basic Transformation or the Axis Offset
	Activate the preset of the selected row of the preset table
	Add multiple rows to the end of the table (2nd soft-key row)
	Copy the highlighted field (2nd soft-key row)
	Insert the copied field (2nd soft-key row)
	Reset the selected row: The control enters – in all columns (2nd soft-key row)
	Insert a single line at the end of the table (2nd soft-key row)
	Delete a single line at the end of the table (2nd soft-key row)



## Protecting presets from being overwritten

You can protect any rows in the preset table from being overwritten with the **LOCKED** column. The write-protected rows are color-highlighted in the preset table.

If you want to overwrite a write-protected row with a manual probing cycle, confirm with **OK** and enter the password (where password-protected).

### NOTICE

#### Caution: Data may be lost!

Rows that were locked with the **LOCK / UNLOCK PASSWORD** function can be unlocked only with the selected password. Forgotten passwords cannot be reset. This means that locked rows would be locked permanently. The preset table would thus no longer be fully usable.

- ▶ Prefer the alternative function **LOCK / UNLOCK**
- ▶ Note down your passwords

Proceed as follows to protect a preset from being overwritten:

- ▶ Press the **CHANGE PRESET** soft key
- ▶ Select the **LOCKED** column
- ▶ Press the **EDIT CURRENT FIELD** soft key

Protection for a preset without using a password:

- ▶ Press the **LOCK / UNLOCK** soft key
- ▶ The control writes an **L** in the **LOCKED** column.

Use a password to protect a preset:

- ▶ Press the **LOCK / UNLOCK PASSWORD** soft key
- ▶ Enter the password in the pop-up window
- ▶ Confirm with the **OK** soft key or with the **ENT** key:
- ▶ The control writes **###** in the **LOCKED** column.

### Rescind write-protection

To edit a row you have previously write-protected, proceed as follows:



- ▶ Press the **CHANGE PRESET** soft key



- ▶ Select the **LOCKED** column



- ▶ Press the **EDIT CURRENT FIELD** soft key

Preset protected without a password:

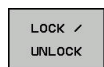

- ▶ Press the **LOCK / UNLOCK** soft key
- > The control rescinds the write-protection.

Preset protected with a password:

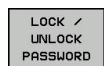

- ▶ Press the **LOCK / UNLOCK PASSWORD** soft key

- ▶ Enter the password in the pop-up window
- ▶ Confirm with the **OK** soft key or with the **ENT** key
- > The control rescinds the write-protection.

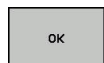

## Activating a preset

### Activate a preset in the Manual operation mode

#### NOTICE

##### Caution: Significant property damage!

Undefined fields in the preset table behave differently from fields defined with the value **0**: Fields defined with the value **0** overwrite the previous value when activated, whereas with undefined fields the previous value is kept.

- ▶ Before activating a preset, check whether all columns contain values.



##### Operating notes:

- When activating a preset from the preset table, the control resets any active datum shift, mirroring, rotation, or scaling factor.
- On the other hand, the **Tilt working plane** function (Cycle **19** or **PLANE**) remains active.



- ▶ Select the **Manual operation** mode



- ▶ Press the **PRESET MANAGEMENT** soft key



- ▶ Select the preset number that you want to activate



- ▶ Or, with the **GOTO** key, select the preset number that you want to activate



- ▶ Confirm with the **ENT** key



- ▶ Press the **ACTIVATE PRESET** soft key



- ▶ Confirm activation of the preset
- ▶ The control sets the display and the basic rotation.



- ▶ Exit the preset table

### Activating a preset in an NC program

Use Cycle 247 in order to activate presets from the preset table during program run. In Cycle 247 you define the number of the preset to be activated.

**Further information:** Cycle Programming User's Manual

## 16.6 Presetting without a 3-D touch probe

### Note

When presetting, you set the control display to the coordinates of a known workpiece position.



All manual probe functions are available with a 3-D touch probe.

**Further information:** "Presetting with a 3-D touch probe (option number 17)", page 676



Refer to your machine manual.

The machine tool builder can disable presetting in individual axes.

### Preparation

- ▶ Clamp and align the workpiece
- ▶ Insert the zero tool with known radius into the spindle
- ▶ Ensure that the control is showing the actual positions

### Presetting setting with an end mill



- ▶ Select the **Manual operation** mode



- ▶ Move the tool slowly until it touches (scratches) the workpiece surface



Setting a preset in an axis:



- ▶ Select the axis
- ▶ The control opens the **PRESETTING Z=** dialog window

Alternative:



- ▶ Press the **SET PRESET** soft key
- ▶ Select the axis via soft key



- ▶ Zero tool in spindle axis: Set the display to a known workpiece position (here, 0) or enter the thickness  $d$  of the shim. In the tool axis, offset the tool radius

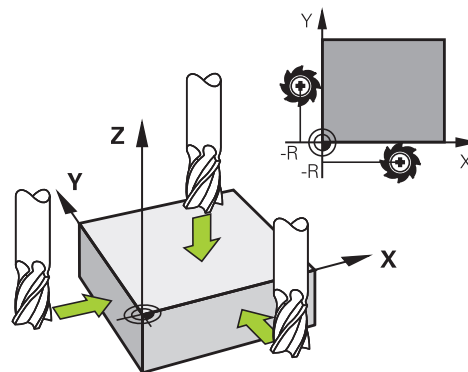

Repeat the process for the remaining axes.

If the tool in the tool axis has already been set, set the display of the tool axis to the length  $L$  of the tool or enter the sum  $Z=L+d$ .



Operating notes:

- The control automatically saves the preset set with the axis keys in row 0 of the preset table.
- If the machine tool builder has locked an axis, then you cannot set a preset in that axis. The soft key for that axis is then not visible.

## Using touch probe functions with mechanical probes or measuring dials

If you do not have an electronic 3-D touch probe on your machine, you can also use all the previously described manual touch probe functions (exception: calibration function) with mechanical probes or by simply touching the workpiece with the tool.

**Further information:** "Using a 3-D touch probe (option 17)", page 654

In place of the electronic signal generated automatically by a 3-D touch probe during probing, you can manually initiate the trigger signal for capturing the **probing position** by pressing a key.

Proceed as follows:

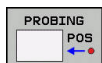

- ▶ Select any touch probe function by soft key
- ▶ Move the mechanical probe to the first position to be captured by the control.



- ▶ To capture the position: Press the **Actual-position-capture** soft key
- > The control saves the current position.
- ▶ Move the mechanical probe to the next position to be captured by the control.



- ▶ To capture the position: Press the **Actual-position-capture** soft key
- > The control saves the current position.
- ▶ If required, move to additional positions and capture as described previously
- ▶ **Preset:** In the menu window, enter the coordinates of the new preset, confirm with the **SET PRESET** soft key, or write the values to a table
- Further information:** "Writing measured values from the touch probe cycles to a datum table", page 661
- Further information:** "Writing measured values from the touch-probe cycles to the preset table", page 662
- ▶ Terminate the probing function: Press the **END** key



If you try to set a preset in a locked axis, the control will issue either a warning or an error message, depending on what the machine tool builder has defined.

## 16.7 Using a 3-D touch probe (option 17)

### Introduction

The behavior of the control during presetting depends on the setting in the optional machine parameter **chkTiltingAxes** (no. 204601):

- **chkTiltingAxes: On** With an active tilted working plane, the control checks during presetting in the X, Y, and Z axes whether the current coordinates of the rotary axes agree with the tilt angles that you defined (3-D ROT menu). If the tilted working plane function is not active, the control checks whether the rotary axes are at 0° (actual positions). If the positions do not match, the control issues an error message.



The probing functions **PL** and **ROT** take the current rotary axes into account, and the probing points are derived from this position.

- **chkTiltingAxes: Off** The control does not check whether the current coordinates of the rotary axes (actual positions) agree with the tilt angles that you defined.

If the machine parameter has not been set, the control checks as if **chkTiltingAxes: On** were set



Always set a preset in all three principal axes. This clearly and correctly defines the preset. That way you also taken into account possible deviations resulting from the tilting of the axes.

## Overview









The following touch probe cycles are available in the **Manual operation** mode:



Refer to your machine manual.  
The control must be specially prepared by the machine tool builder for the use of a 3-D touch probe.



HEIDENHAIN only gives warranty for the function of the probing cycles if HEIDENHAIN touch probes are used.

Soft key	Function	Page
	Calibrating the 3-D Touch Probe	663
	Measuring a 3-D basic rotation by probing a plane	673
	Measuring a basic rotation using a line	670
	Setting the preset on any axis	677
	Set a corner as preset	678
	Set a circle center as preset	680
	Setting the centerline as preset	683
	Touch probe system data management	See Cycle Programming User's Manual



For more information about the touch probe table, refer to the User's Manual for Cycle Programming

### Traverse movements with a handwheel with display

With a handwheel with display, it is possible to transfer control to the handwheel during a manual touch probe cycle.

Proceed as follows:

- ▶ Start the manual touch probe cycle
- ▶ Position the touch probe at a position near the first touch point
- ▶ Probe the first touch point
- ▶ Activate the handwheel on the handwheel
- > The control shows the pop-up window **Handwheel active**.
- ▶ Position the touch probe at a position near the second touch point
- ▶ Deactivate the handwheel on the handwheel
- > The control closes the pop-up window.
- ▶ Probe the second touch point
- ▶ If necessary, set the preset
- ▶ End the probing function



If the handwheel is active you cannot start the probing cycles.



## Suppress touch probe monitoring

### Suppress touch probe monitoring

If the stylus is deflected, the control issues an error message as soon as you want to move a machine axis.

You must deactivate touch-probe monitoring in the **Manual operation** mode in order to use a positioning block to retract a touch probe after it has deflected.

You can deactivate touch-probe monitoring for 30 seconds with the **TCH PROBE MONITOR OFF** soft key.

The control issues the error message **The touch probe monitor is deactivated for 30 seconds**. The error message automatically clears itself after 30 seconds.



If the touch probe receives a stable signal within the 30 seconds, such as "Touch probe not deflected," then touch-probe monitoring reactivates itself automatically and the error message is cleared.

### NOTICE







#### Danger of collision!

The **TCH PROBE MONITOR OFF** soft key suppresses the corresponding error message if the stylus is deflected. The control does not perform an automatic collision check with the stylus. Because of this behavior, you must check whether the touch probe can retract safely. There is a risk of collision if you choose the wrong direction for retraction.

- ▶ Carefully move the axes in the **Manual operation** mode

## Functions in touch probe cycles

Soft keys that are used to select the probing direction or a probing routine are displayed in the manual touch probe cycles. The soft keys displayed vary depending on the respective cycle:

Soft key	Function
	Select the probing direction
	Capture the actual position
	Probe hole (inside circle) automatically
	Probe stud (outside circle) automatically
	Probe a model circle (center point of several elements)
	Select a paraxial probing direction for probing of holes, studs and model circles

**Automatic probing routine for holes, studs and model circles****NOTICE****Danger of collision!**

The control does not perform an automatic collision check with the stylus. During automatic probing procedures the control positions the touch probe to the probing positions automatically. There is a risk of collision if pre-positioning was not correct or if obstacles have been ignored.

- ▶ Program a suitable pre-position
- ▶ Use safety clearances to take obstacles into account

If you use a probing routine for automatic probing of a hole, stud, or a pattern circle, the control opens a form with the required entry fields.

**Input fields in the Measure stud and Measure hole forms**

Input field	Function
<b>Stud diameter? or Hole diameter</b>	Diameter of probe contact (optional for holes)
<b>Safety clearance?</b>	Distance to the probe contact in the plane
<b>Incr. clearance height?</b>	Positioning of touch probe in spindle axis direction (starting from the current position)
<b>Starting angle?</b>	Angle for the first probing operation ( $0^\circ$ = positive direction of principal axis, i.e. in X+ for spindle axis Z). All other probe angles result from the number of touch points.
<b>Number of touch points?</b>	Number of probing operations (3 to 8)
<b>Angular length?</b>	Probing a full circle ( $360^\circ$ ) or a circle segment (angular length $< 360^\circ$ )

Automatic probing routine:

- ▶ Pre-position touch probe



- ▶ Select the probing function: Press the **PROBING CC** soft key



- ▶ Hole should be probed automatically: Press the **HOLE** soft key

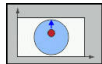

- ▶ Select paraxial probing direction
- ▶ Start probing function: Press the **NC start** key
- ▶ The control carries out all pre-positioning and probing processes automatically.

The control approaches the position at the feed rate **FMAX** defined in the touch probe table. The defined probing feed rate **F** is used for the actual probing operation.



Operating and programming notes:

- Before starting an automatic probing routine, you need to preposition the touch probe near the first touch point. Offset the touch probe by approximately the safety clearance opposite to the probing direction. The safety clearance is derived from the sum of the values in the touch-probe table and in the entry form.
- For inside circles with large diameters, the control can also position the touch probe on a circular arc at the feed rate **FMAX**. This requires that you enter a safety clearance for prepositioning and the hole diameter in the input form. Position the touch probe inside the hole at a position that is offset by approximately the safety clearance from the wall. Take the starting angle of the first probing process into account in pre-positioning; for example, at a starting angle of 0° the control will first probe in the positive direction of the reference axis.

## Selecting the probing cycle

- ▶ Select the **Manual operation** or **Electronic handwheel** mode of operation



- ▶ Select the probing functions: Press the **TOUCH PROBE** soft key

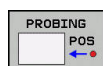

- ▶ Select the touch probe cycle by pressing the appropriate soft key, for example **PROBING POS**
- ▶ The control displays the associated menu.



Operating notes:

- When you select a manual probing function, the control opens a form displaying all data required. The content of the forms varies depending on the respective function.
- You can also enter values in some of the fields. Use the arrow keys to switch to the desired input field. You can position the cursor only in fields that can be edited. Fields that cannot be edited are dimmed.

## Recording measured values from the touch probe cycles



Refer to your machine manual.

The control must be specially prepared by the machine tool builder for use of this function.

After executing the respective touch-probe cycle, the control writes the measured values to the TCHPRMAN.html file.

If you have not defined a path in the machine parameter **FN16DefaultPath** (no. 102202), the control will store the TCHPRMAN.html file in the **TNC:\** main directory.



Operating notes:

- If you run several touch probes cycles in a row, the control stores the measured values below each other.

## Writing measured values from the touch probe cycles to a datum table



If you want to save measured values in the workpiece coordinate system, use the **ENTER IN DATUM TABLE** function. If you want to save measured values in the basic coordinate system, use the **ENTRY IN PRESET TABLE** function.

**Further information:** "Writing measured values from the touch-probe cycles to the preset table", page 662

With the **ENTER IN DATUM TABLE** soft key, the control can write the values measured during any touch-probe cycle to a datum table:

- ▶ Select any probe function
- ▶ Enter the desired coordinates for the datum in the designated input boxes (depends on the touch probe cycle being run)
- ▶ Enter the datum number in the **Number in table?** input field
- ▶ Press the **ENTER IN DATUM TABLE** soft key
- > The control saves the datum in the indicated datum table under the entered number.

## Writing measured values from the touch-probe cycles to the preset table



If you want to save measured values in the basic coordinate system, use the **ENTRY IN PRESET TABLE** function. If you want to save measured values in the workpiece coordinate system, use the **ENTER IN DATUM TABLE** function.

**Further information:** "Writing measured values from the touch probe cycles to a datum table", page 661

With the **ENTRY IN PRESET TABLE** soft key, the control can write the values measured during any probe cycle in the preset table. The measured values are then stored referenced to the machine coordinate system (REF coordinates). The preset table has the name PRESET.PR, and is saved in the TNC:\table\ directory.

- ▶ Select any probe function
- ▶ Enter the desired coordinates for the preset in the designated input boxes (depends on the touch probe cycle being run)
- ▶ Enter the preset number in the **Number in table?** input field
- ▶ Press the **ENTRY IN PRESET TABLE** soft key
- > The control opens the **Overwrite active preset?** menu.
- ▶ Press the **OVERWRITE PRESET** soft key
- > The control saves the preset in the preset table under the entered number.
  - Preset number does not exist: The control saves the row only after pressing the **CREATE LINE** (Create line in table?)
  - Preset number is protected: Press the **ENTRY IN LOCKED LINE** soft key to overwrite the active preset
  - Preset number is password-protected: Press the **ENTRY IN LOCKED LINE** soft key and enter the password to overwrite the active preset



The control displays a note if a table row cannot be written to because of disabling. The probing function itself is not interrupted.

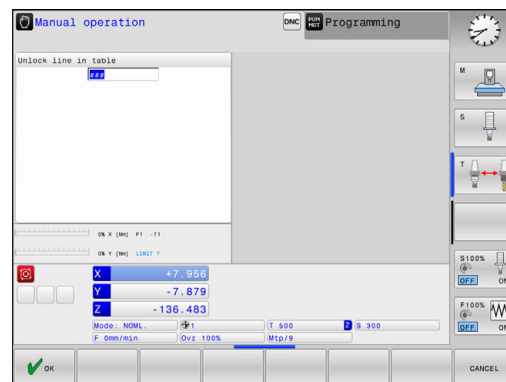

## 16.8 Calibrating 3-D touch probes (option 17)

### Introduction

In order to precisely specify the actual trigger point of a 3-D touch probe, you must first calibrate the touch probe, otherwise the control cannot provide precise measuring results.



#### Operating notes:

- Always calibrate the touch probe again in the following cases:
  - Initial configuration
  - Broken stylus
  - Stylus exchange
  - Change in the probe feed rate
  - Irregularities caused, for example, when the machine heats up
  - Change of active tool axis
- When you press the **OK** soft key after calibration, the calibration values are applied to the active touch probe. The updated tool data then become immediately effective, there is no need to retrieve the tool again.

During calibration, the control finds the effective length of the stylus and the effective radius of the ball tip. To calibrate the 3-D touch probe, clamp a ring gauge or a stud of known height and known radius to the machine table.

The control provides calibration cycles for calibrating the length and the radius:





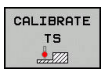

- ▶ Press the **TOUCH PROBE** soft key



- ▶ Display the calibration cycles: Press **CALIBRATE TS**
- ▶ Select the calibration cycle

### Calibration cycles

Soft key	Function	Page
	Calibrating the length	664
	Measure the radius and the center offset using a calibration ring	665
	Measure the radius and the center offset using a stud or a calibration pin	665
	Measure the radius and the center offset using a calibration sphere	665

## Calibrating the effective length



HEIDENHAIN only gives warranty for the function of the probing cycles if HEIDENHAIN touch probes are used.



The effective length of the touch probe is always referenced to the tool reference point. The tool reference point is often on the spindle nose (and face of the spindle). The machine manufacturer may also place the tool reference point at a different point.

- ▶ Set the preset in the spindle axis such that for the machine tool table Z=0.

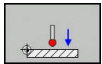

- ▶ Select the calibration function for the touch probe length: Press the **CAL**. Press **L**
- ▶ The control displays the current calibration data.
- ▶ **Datum for length?:** Enter the height of the ring gauge in the menu window
- ▶ Move the touch probe to a position just above the ring gauge
- ▶ To change the traverse direction (if necessary), press a soft key or an arrow key
- ▶ Probe surface: Press **NC Start** key
- ▶ Check results
- ▶ Press the **OK** soft key for the values to take effect
- ▶ Press the **CANCEL** soft key to terminate the calibrating function.
- ▶ The control logs the calibration process in the TCHPRMAN.html file.

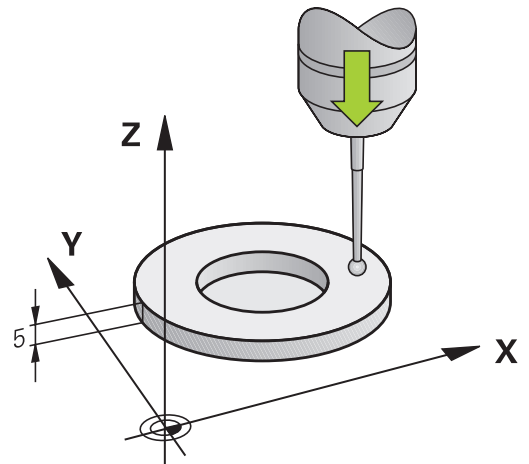



## Calibrating the effective radius and compensating center misalignment



HEIDENHAIN only gives warranty for the function of the probing cycles if HEIDENHAIN touch probes are used.

When calibrating the ball-tip radius, the control executes an automatic probing routine. In the first run the control finds the midpoint of the calibration ring or stud (approximate measurement) and positions the touch probe in the center. Then, in the actual calibration process (fine measurement), the radius of the ball tip is ascertained. If the touch probe allows probing from opposite orientations, the center offset is determined during another cycle.

The property of whether or how your touch probe can be oriented is predefined for HEIDENHAIN touch probes. Other touch probes are configured by the machine tool builder.

After the touch probe is inserted, it normally needs to be aligned exactly with the spindle axis. The calibration function can determine the offset between touch probe axis and spindle axis by probing from opposite orientations (rotation by 180°) and can calculate and implement the necessary compensation.



The center offset can be determined only with a suitable touch probe.

If you want to calibrate using the outside of an object, you need to preposition the touch probe above the center of the calibration sphere or calibration pin. Ensure that the touch points can be approached without collision.

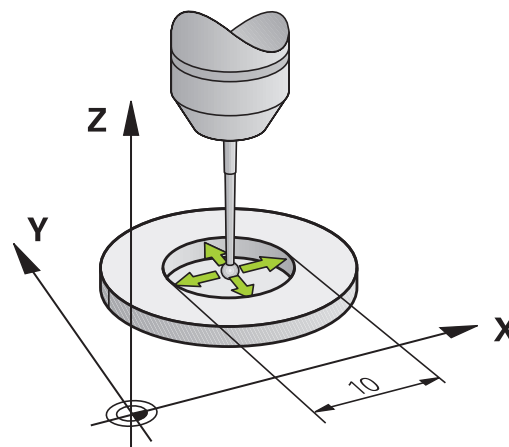

The calibration routine varies depending on how your touch probe can be oriented:

- No orientation possible, or orientation in only one direction: The control executes one approximate and one fine measurement, and then ascertains the effective ball tip radius (column R in tool.t).
- Orientation possible in two directions (e.g. HEIDENHAIN touch probes with cable): The control executes one approximate and one fine measurement, rotates the touch probe by 180°, and then executes another probing routine. The center offset (CAL\_OF in tchprobe.tp) is determined in addition to the radius by probing from opposite orientations.
- Any orientation possible (e.g. HEIDENHAIN touch probes with infrared transmission): The control executes one approximate and one fine measurement, rotates the touch probe by 180°, and then executes another probing routine. The center offset (CAL\_OF in tchprobe.tp) is determined in addition to the radius by probing from opposite orientations.

### Calibration using a calibration ring

Proceed as follows for manual calibration using a calibration ring:



- ▶ In the **Manual operation** mode, position the ball tip inside the bore of the ring gauge
- ▶ Select the calibration function: Press the **CAL. R** soft key
- > The control displays the current calibration data.
- ▶ Enter the diameter of the ring gauge
- ▶ Enter the start angle
- ▶ Enter the number of touch points
- ▶ Probe: Press the **NC Start** key
- > The 3-D touch probe probes all required touch points in an automatic probing routine and calculates the effective ball-tip radius. If probing from opposite orientations is possible, the control calculates the center offset.
- ▶ Check results
- ▶ Press the **OK** soft key for the values to take effect
- ▶ Press the **END** soft key to terminate the calibrating function.
- > The control logs the calibration process in the TCHPRMAN.html file.



Refer to your machine manual.

In order to be able to determine ball-tip center misalignment, the control needs to be specially prepared by the machine manufacturer.

### Calibration with a stud or calibration pin

Proceed as follows for manual calibration with a stud or calibration pin:

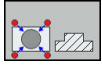

- ▶ In the **Manual operation** mode, position the ball tip above the center of the calibration pin
- ▶ Select the calibration function: Press the **CAL. R** soft key
- ▶ Enter the outside diameter of the stud
- ▶ Enter the safety clearance
- ▶ Enter the start angle
- ▶ Enter the number of touch points
- ▶ Probe: Press the **NC Start** key
- ▶ The 3-D touch probe probes all required touch points in an automatic probing routine and calculates the effective ball-tip radius. If probing from opposite orientations is possible, the control calculates the center offset.
- ▶ Check results
- ▶ Press the **OK** soft key for the values to take effect
- ▶ Press the **END** soft key to terminate the calibrating function.
- ▶ The control logs the calibration process in the TCHPRMAN.html file.



Refer to your machine manual.

In order to be able to determine ball-tip center misalignment, the control needs to be specially prepared by the machine manufacturer.

### Calibration using a calibration sphere

Proceed as follows for manual calibration using a calibration sphere:

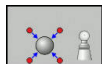

- ▶ In the **Manual operation** mode, position the ball tip above the center of the calibration sphere
- ▶ Select the calibration function: Press the **CAL. R** soft key
- ▶ Enter the outside diameter of the ball
- ▶ Enter the safety clearance
- ▶ Enter the start angle
- ▶ Enter the number of touch points
- ▶ Select Length measurement, if applicable
- ▶ If necessary, input the reference for the length
- ▶ Probe: Press the **NC Start** key
- ▶ The 3-D touch probe probes all required touch points in an automatic probing routine and calculates the effective ball-tip radius. If probing from opposite orientations is possible, the control calculates the center offset.
- ▶ Check results
- ▶ Press the **OK** soft key for the values to take effect
- ▶ Press the **END** soft key to terminate the calibrating function
- ▶ The control logs the calibration process in the TCHPRMAN.html file.



Refer to your machine manual.

In order to be able to determine ball-tip center misalignment, the control needs to be specially prepared by the machine manufacturer.

### Displaying calibration values

The control saves the effective length and effective radius of the touch probe in the tool table. The control saves the touch probe center offset to the touch probe table in the columns **CAL\_OF1** (principal axis) and **CAL\_OF2** (minor axis). You can display the values on the screen by pressing the **TCH PROBE TABLE** soft key.

During calibration, the control automatically creates the TCHPRMAN.html log file to which the calibration values are saved.



Ensure that the tool number of the tool table and the touch-probe number of the touch-probe table are correct. This is regardless of whether you want to use a touch-probe cycle in automatic mode or **Manual operation** mode.



For more information about the touch probe table, refer to the User's Manual for Cycle Programming

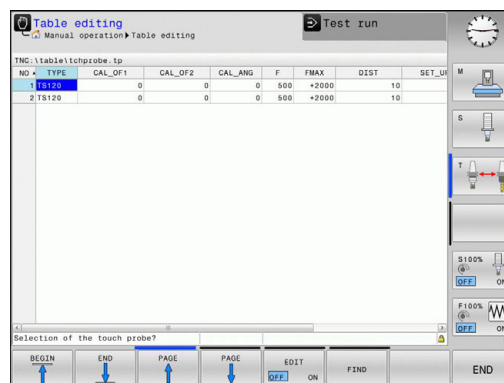

## 16.9 Compensating workpiece misalignment with 3-D touch probe (option 17)

### Introduction



Refer to your machine manual.

It depends on the machine whether you can compensate workpiece misalignment with an offset (angle for table rotation).



HEIDENHAIN only gives warranty for the function of the probing cycles if HEIDENHAIN touch probes are used.

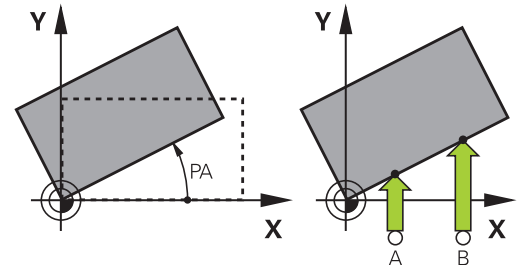

The control compensates workpiece misalignment either mathematically by computing a basic rotation (angle of basic rotation) or by an offset (angle for table rotation)

For this purpose, the control sets the rotation angle to the desired angle with respect to the reference axis in the working plane.

**Basic rotation:** The control interprets the measured angle as rotation around the tool direction, and saves the values in the columns SPA, SPB, or SPC of the preset table.

**Offset:** The control interprets the measured angle as a shift in each axis in the machine coordinate system, and saves the values in the columns A\_OFFS, B\_OFFS, or C\_OFFS of the preset table.

In order to identify the basic rotation or offset, probe two points on the side of the workpiece. The sequence in which you probe the points influences the calculated angle. The measured angle goes from the first to the second probing point. You can also determine the basic rotation or offset using holes or studs.



Operating and programming notes:

- Select the probe direction perpendicular to the angle reference axis when measuring workpiece misalignment.
- To ensure that the basic rotation is calculated correctly during program run, program both coordinates of the working plane in the first positioning block.
- You can also use a basic rotation in conjunction with the **PLANE** function (except for **PLANE AXIAL**). In this case first activate the basic rotation and then the **PLANE** function.
- You can also activate a basic rotation or offset without probing a workpiece. To do so, enter a value in the corresponding input field and press the **SET BASIC ROTATION** or **SET TABLE ROTATION** soft key.
- The behavior of the control during presetting depends on the setting in the machine parameter **chkTiltingAxes** (no. 204601).

**Further information:** "Introduction", page 654

## Identifying basic rotation

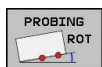

- ▶ Press the **Probe rotation** soft key
- > The control opens the **Probing of rotation** menu.
- ▶ The following input fields are displayed:
  - **Angle of basic rotation**
  - **Offset of rotary table**
  - **Number in table?**
- > The control displays any current basic rotation or offset in the input field.
- ▶ Position the touch probe at a position near the first touch point
- ▶ Select the probe direction or probing routine by soft key
- ▶ Press the **NC Start** key
- ▶ Position the touch probe at a position near the second touch point
- ▶ Press the **NC Start** key
- > The control determines the basic rotation and offset and displays them.
- ▶ Press the **SET BASIC ROTATION** soft key
- ▶ Press the **END** soft key

The control logs the probing process in TCHPRMAN.html.

## Saving the basic rotation in the preset table

- ▶ After the probing process, enter the preset number in which the control is to save the active basic rotation in the **Number in table?** input field
- ▶ Press the **BASIC ROT. IN PRESET TABLE** soft key
- > If appropriate, the control opens the **Overwrite active preset?** menu.
- ▶ Press the **OVERWRITE PRESET** soft key
- > The control saves the basic rotation in the preset table.

## Compensation of workpiece misalignment by rotating the table

There are three possibilities for compensating workpiece misalignment by rotating the table:

- Align rotary table
- Set table rotation
- Save table rotation in the preset table

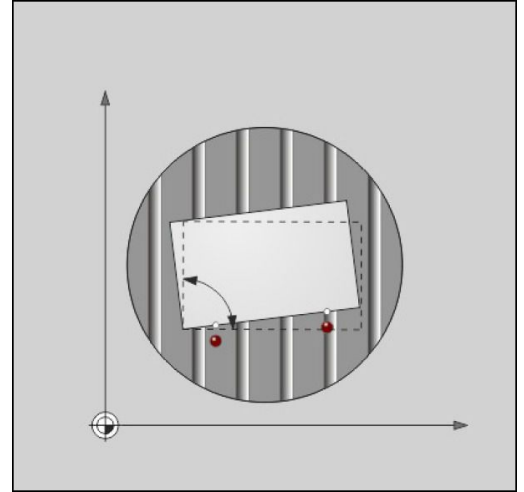

### Align rotary table

You can compensate the ascertained misalignment by positioning the rotary table.



Pre-position all axes before rotating the table, in order to preclude collisions resulting from compensating movements. The control additionally outputs a warning before table rotation.

- ▶ Press the **ALIGN ROT. TABLE** soft key after the probing procedure
- > The control opens the warning.
- ▶ Clear with the **OK** soft key if needed
- ▶ Press the **NC Start** key
- > The control aligns the rotary table.

### Set table rotation

You can set a manual preset in the axis of the rotary table.

- ▶ Press the **SET TABLE ROTATION** soft key after the probing procedure
- > If a basic rotation is already set, the control opens the **Reset basic rotation?** menu.
- ▶ Press the **DELETE BASIC ROT.** soft key
- > The control deletes the basic rotation from the preset table, and inserts the offset.
- ▶ Or press **KEEP BASIC ROT.**
- > The control inserts the offset in the preset table, and the basic rotation also remains.

### Save table rotation in the preset table

You can save the misalignment of the rotary table in any row of the preset table. The control stores the angle in the offset column of the rotary table, e.g. in the C\_OFFS column for a C axis.

- ▶ Press the **TABLE ROT. IN PRESET TABLE** soft key after the probing procedure
- > If appropriate, the control opens the **Overwrite active preset?** menu.
- ▶ Press the **OVERWRITE PRESET** soft key
- > The control saves the offset in the preset table.

You may have to change the view in the preset table with the **BASE TRANSFORM./OFFSET** soft key for this column to be displayed.

### Show basic rotation and offset

If you select the **PROBING ROT** function, the control displays the active angle of the basic rotation in the **Angle of basic rotation** input field and the active offset in the **Offset of rotary table** input field.

In addition, the rotary angle and the offset are shown in the split screen **PROGRAM + STATUS** screen layout on the **STATUS POS.** tab.

When the control moves the machine axis in accordance with the basic rotation, a symbol for the basic rotation is shown in the status display.

### Rescind basic rotation or offset

- ▶ Select the probe function by pressing the **PROBING ROT** soft key
- ▶ Enter **Angle of basic rotation: 0**
- ▶ Or enter **Offset of rotary table: 0**
- ▶ Apply with the **SET BASIC ROTATION** soft key
- ▶ Or apply with the **SET TABLE ROTATION** soft key
- ▶ To terminate the probe function, press the **END** soft key



## Measuring 3-D basic rotation

The misalignment of any tilted plane can be measured by probing 3 positions. The **Probe in plane** function enables you to measure this misalignment and save it as a 3-D basic rotation in the preset table.



Operating and programming notes:

- The sequence and position of the touch points determines how the control calculates the direction of the plane.
- With the first two points you specify the direction of the reference axis. Define the second point in the positive direction of the desired reference axis. The position of the third point determines the direction of the minor axis and tool axis. Define the third point in the positive Y axis of the desired workplace coordinate system.
  - 1st point is on the reference axis
  - 2nd point is on the reference axis, in a positive direction from the first point
  - 3rd point is on the minor axis, in a positive direction of the desired workpiece coordinate system

Optionally inputting a datum angle enables you to define the nominal direction of the probed plane.

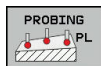

- ▶ Select the probe function by pressing the **PROBING PL** soft key
- ▶ The control displays the current 3-d rotation.
- ▶ Position the touch probe at a position near the first touch point
- ▶ Select the probe direction or probing routine by soft key
- ▶ Probe: Press the **NC Start** key
- ▶ Position the touch probe at a position near the second touch point
- ▶ Probe: Press the **NC Start** key
- ▶ Position the touch probe near the third touch point
- ▶ Probe: Press the **NC Start** key.
- ▶ The control measures the 3-D basic rotation and displays the values for SPA, SPB, and SPC in relation to the active coordinate system.
- ▶ If required, enter the datum angle

Activate 3-D basic rotation:

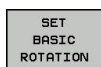

- ▶ Press the **SET BASIC ROTATION** soft key

Save the 3-D rotation in the preset table:

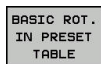

- ▶ Press the **BASIC ROT. IN PRESET TABLE** soft key



- ▶ To terminate the probe function, press the **END** soft key

The control saves the 3-D basic rotation in the columns SPA, SPB, and SPC of the preset table.

### Aligning 3-D basic rotation

If the machine has two rotary axes and the probed 3-D basic rotation is activated, you can align the rotary axes with reference to the 3-D basic rotation using the **ALIGN ROT. AXES** soft key. In such cases, Tilted Working Plane becomes active for all machine operating modes.

After aligning the plane, you can align the reference axis with the **Probing rot** function.

### Displaying 3-D basic rotation

If a 3-D basic rotation is saved in the active preset, the control shows the  symbol for the 3-D basic rotation in the status display. The control moves the machine axes according to the 3-D basic rotation.

### Canceling a 3-D basic rotation

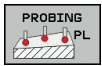

- ▶ Select the probe function by pressing the **PROBING PL** soft key
- ▶ Enter 0 for all angles
- ▶ Press the **SET BASIC ROTATION** soft key
- ▶ To terminate the probe function, press the **END** soft key

## 16.10 Presetting with a 3-D touch probe (option number 17)

### Overview







Refer to your machine manual.

The machine tool builder can disable presetting in individual axes.

If you try to set a preset in a locked axis, the control will issue either a warning or an error message, depending on what the machine tool builder has defined.

The following soft-key functions are available for setting a preset on an aligned workpiece:

Soft key	Function	Page
	Presetting on any axis	677
	Setting a corner as preset	678
	Setting a circle center as preset	680
	Center line as preset Setting the center line as preset	683



With an active datum shift the determined value is with respect to the current preset (possibly a manual preset from the **Manual operation** mode). The datum shift is included in the position display.

## Presetting on any axis



HEIDENHAIN only gives warranty for the function of the probing cycles if HEIDENHAIN touch probes are used.

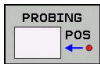

- ▶ Select the probing function by pressing the **POSITION PROBING** soft key
- ▶ Move the touch probe to a position near the touch point
- ▶ Select the axis and probing direction, e.g. Probe in direction Z-
- ▶ Probe: Press the **NC Start** key
- ▶ **Preset:** Enter the nominal coordinate
- ▶ Apply with the **SET PRESET** soft key
- ▶ **Further information:** "Writing measured values from the touch probe cycles to a datum table", page 661
- ▶ **Further information:** "Writing measured values from the touch-probe cycles to the preset table", page 662
- ▶ To terminate the probe function, press the **END** soft key

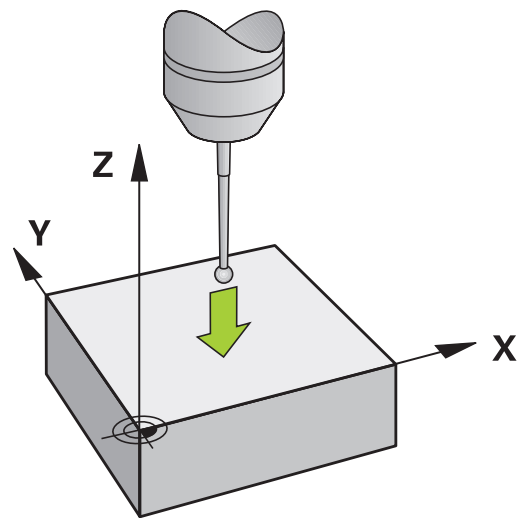

## Corner as preset



Refer to your machine manual.

It depends on the machine whether you can compensate workpiece misalignment with an offset (angle for table rotation).



HEIDENHAIN only gives warranty for the function of the probing cycles if HEIDENHAIN touch probes are used.

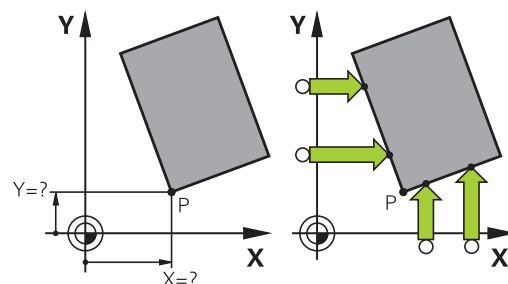

The "Corner as preset" probing cycle identifies the angle and intersection of two straight lines.

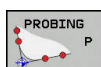

- ▶ Select the probing function: Press the **PROBING P** soft key
- ▶ Position the touch probe near the first touch point on the first workpiece edge
- ▶ Select the probe direction by soft key
- ▶ Probe: Press the **NC Start** key
- ▶ Position the touch probe near the second touch point on the same workpiece edge
- ▶ Probe: Press the **NC Start** key
- ▶ Position the touch probe near the first touch point on the second workpiece edge
- ▶ Select the probe direction by soft key
- ▶ Probe: Press the **NC Start** key
- ▶ Position the touch probe near the second touch point on the same workpiece edge
- ▶ Probe: Press the **NC Start** key
- ▶ **Preset:** Enter both coordinates of the preset in the menu window
- ▶ Apply with the **SET PRESET** soft key
- ▶ **Further information:** "Writing measured values from the touch probe cycles to a datum table", page 661
- ▶ **Further information:** "Writing measured values from the touch-probe cycles to the preset table", page 662
- ▶ To terminate the probe function, press the **END** soft key



You can identify the intersection of two straight lines by holes or studs and set this as the preset.

In addition to presetting, you can also activate a basic rotation or an offset with the cycle. The control has two soft keys for you to decide which straight line you wish to use for this.

The **ROT 1** soft key activates the angle of the first straight line as basic rotation or as offset, and the **ROT 2** soft key activates the angle of the second straight line.

If you activate the basic rotation, the control automatically writes the positions and the basic rotation to the preset table.

If you activate the offset, the control automatically writes the positions and the offset or only the positions to the preset table.

## Circle center as preset

With this function, you can set the preset at the center of bore holes, circular pockets, cylinders, studs, circular islands, etc.

### Inside circle:

The control probes the inside wall of a circle in all four coordinate axis directions.

For incomplete circles (circular arcs) you can choose the appropriate probing direction.



- ▶ Position the touch probe approximately in the center of the circle
- ▶ Select the touch probe function: Press the **PROBING CC** soft key
- ▶ Select the soft key for the desired probing direction
- ▶ Probe: Press the **NC Start** key. The touch probe probes the inside wall of the circle in the selected direction. Repeat this process. After the third probing operation, you can have the control calculate the center (four touch points are recommended)
- ▶ Terminate the probing procedure and switch to the evaluation menu: Press the **EVALUATE** soft key
- ▶ **Preset:** Enter both coordinates of the center of the circle in the menu window
- ▶ Apply with the **SET PRESET** soft key
  - Further information:** "Writing measured values from the touch probe cycles to a datum table", page 661
  - Further information:** "Writing measured values from the touch-probe cycles to the preset table", page 662
- ▶ To terminate the probe function, press the **END** soft key

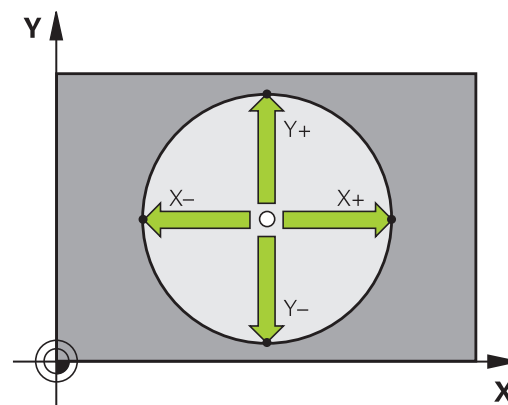

The control needs at least three touch points to calculate outside or inside circles, e.g. with circle segments. More precise results are obtained with four touch points. If possible, always pre-position the touch probe to the center.



**Outside circle:**

- ▶ Position the touch probe at a position near the first touch point outside of the circle
- ▶ Select the touch probe function: Press the **PROBING CC** soft key
- ▶ Select the soft key for the desired probing direction
- ▶ Probe: Press the **NC Start** key. The touch probe probes the inside wall of the circle in the selected direction. Repeat this process. After the third probing operation, you can have the control calculate the center (four touch points are recommended)
- ▶ Terminate the probing procedure and switch to the evaluation menu: Press the **EVALUATE** soft key
- ▶ **Preset:** Enter the coordinates of the preset
- ▶ Apply with the **SET PRESET** soft key
  - Further information:** "Writing measured values from the touch probe cycles to a datum table", page 661
  - Further information:** "Writing measured values from the touch-probe cycles to the preset table", page 662
- ▶ To terminate the probe function, press the **END** soft key

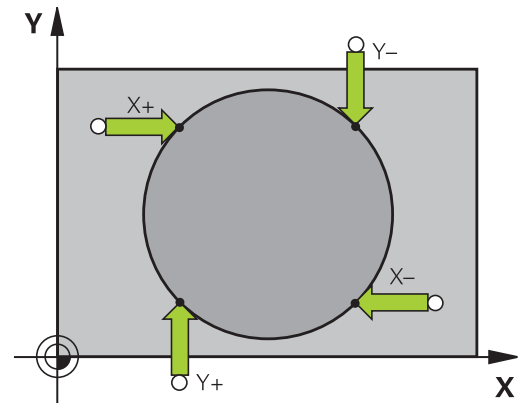

Once the probing routine is completed, the control displays the current coordinates of the circle center and the circle radius.

### Setting the preset using multiple holes/cylindrical studs

The manual probing function **Probing of circular pattern** is part of the **Cir** probing function. Individual circles can be determined with paraxial probing operations.

A second soft-key row provides the soft key **PROBING CC (Probing of circular pattern)** for using multiple holes or circular studs to set the preset. You can set the intersection of two or more elements as preset.

### Setting the preset in the intersection of multiple holes/ circular studs:

- ▶ Pre-position touch probe

Select **Model Circle** probing function



- ▶ Select the touch probe function: Press the **PROBING CC** soft key



- ▶ Press the **PROBING CC (Probing of circular pattern)** soft key

Probe a circular stud

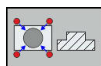

- ▶ Circular stud should be probed automatically: Press **Stud** soft key

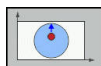

- ▶ Enter starting angle or select using soft key



- ▶ Start probing function: Press the **NC Start** key

Probe the hole.



- ▶ Hole should be probed automatically: Press the **Hole** soft key

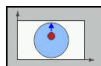

- ▶ Enter starting angle or select using soft key



- ▶ Start probing function: Press the **NC Start** key
- ▶ Repeat the probing procedure for the remaining elements
- ▶ Terminate the probing procedure and switch to the evaluation menu: Press the **EVALUATE** soft key
- ▶ **Preset:** Enter both coordinates of the center of the circle in the menu window
- ▶ Apply with the **SET PRESET** soft key
- ▶ **Further information:** "Writing measured values from the touch probe cycles to a datum table", page 661
- ▶ **Further information:** "Writing measured values from the touch-probe cycles to the preset table", page 662
- ▶ To terminate the probe function, press the **END** soft key

## Setting a center line as preset

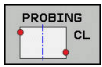

- ▶ Select the probing function: Press the **PROBING CL** soft key
  - ▶ Position the touch probe at a position near the first touch point
  - ▶ Select the probing direction by soft key
  - ▶ Probe: Press the **NC Start** key
  - ▶ Position the touch probe at a position near the second touch point
  - ▶ Probe: Press the **NC Start** key
  - ▶ **Preset:** Enter the coordinates of the preset in the menu window, confirm with the **SET PRESET** soft key, or write the value to a table
- Further information:** "Writing measured values from the touch probe cycles to a datum table", page 661
- Further information:** "Writing measured values from the touch-probe cycles to the preset table", page 662
- ▶ To terminate the probe function, press the **END** soft key



If you desire, then after the second touch point you can change the position of the centerline in the evaluation menu, and thus the axis for setting the preset. Use the soft keys to choose between principal axis, secondary axis, and tool axis. This way you can determine the positions once, and then store them in the principal axis as well as in the secondary axis.

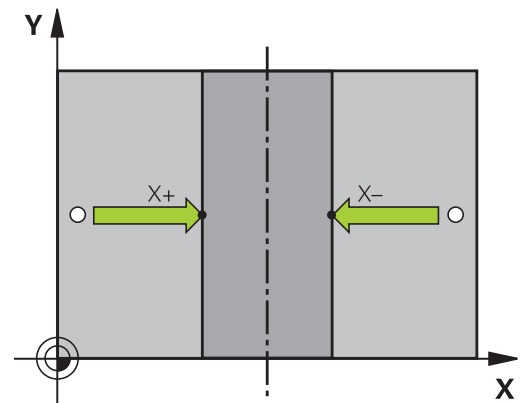
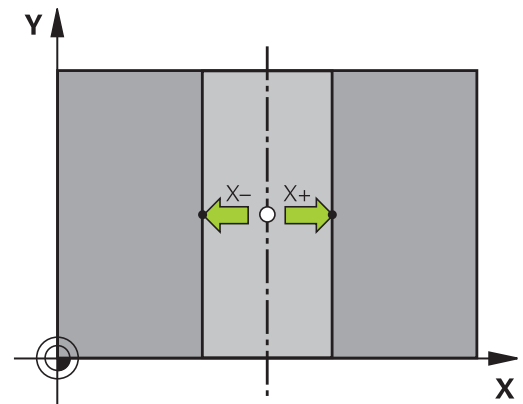

## Measuring workpieces with a 3-D touch probe

You can also use the touch probe in the **Manual operation** and **Electronic handwheel** operating modes to perform simple measurements on the workpiece. Numerous programmable touch probe cycles are available for more complex measuring tasks.

**Further information:** Cycle Programming User's Manual

With a 3-D touch probe you can determine:

- Position coordinates, and from them,
- Dimensions and angles on the workpiece

### Finding the coordinates of a position on an aligned workpiece

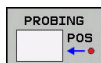

- ▶ Select the probing function: Press the **PROBING POS** soft key
- ▶ Move the touch probe to a position near the touch point
- ▶ Select the probing direction and the axis to which the coordinates relate: Use the corresponding soft keys to select
- ▶ Start the probing process: Press the **NC Start** key

The control shows the coordinates of the touch point as preset.

### Finding the coordinates of a corner point on the working plane

Find the coordinates of the corner point.

**Further information:** "Corner as preset", page 678

The control displays the coordinates of the probed corner as preset.

### Measuring workpiece dimensions

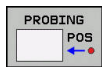

- ▶ Select the probing function: Press the **PROBING POS** soft key
- ▶ Position the touch probe at a position near the first touch point A
- ▶ Select the probing direction by soft key
- ▶ Probe: Press the **NC Start** key
- ▶ If you need the current preset later, write down the value that appears in the display
- ▶ Preset: Enter **0**.
- ▶ Cancel the dialog: Press the **END** key
- ▶ Select the probing function again: Press the **PROBING POS** soft key
- ▶ Position the touch probe at a position near the second touch point B
- ▶ Select the probe direction with the soft keys: Same axis but from the opposite direction
- ▶ Probe: Press the **NC Start** key

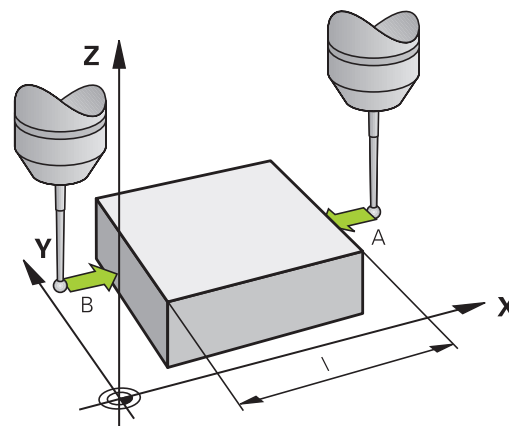

The **Measured value** display shows the distance between the two points on the coordinate axis.

#### To return to the values that were active before the length measurement:

- ▶ Select the probing function: Press the **PROBING POS** soft key
- ▶ Probe the first touch point again
- ▶ Set the preset to the value that you wrote down previously
- ▶ Cancel the dialog: Press the **END** key

### Measuring angles

You can use the 3-D touch probe to measure angles in the working plane. You can measure

- The angle between the angle reference axis and a workpiece edge; or
- the angle between two sides

The measured angle is displayed as a value of max. 90°.

### Finding the angle between the angle reference axis and a workpiece edge

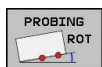

- ▶ Select the probe function by pressing the **PROBING ROT** soft key
- ▶ Rotation angle: If you wish to restore the current basic rotation later, note the value that appears under Rotation Angle
- ▶ Perform a basic rotation with the workpiece edge to be compared  
**Further information:** "Compensating workpiece misalignment with 3-D touch probe (option 17)", page 669
- ▶ Press the **PROBING ROT** soft key to display the angle between the angle reference axis and the workpiece edge as the rotation angle
- ▶ Cancel the basic rotation, or restore the previous basic rotation
- ▶ Set the rotation angle to the value that you previously wrote down

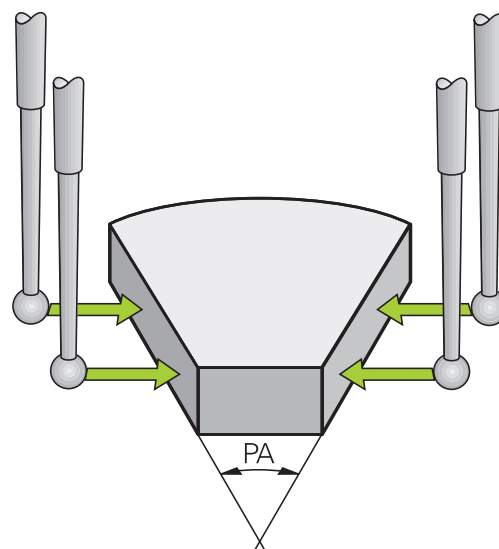

### Measuring the angle between two workpiece edges

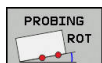

- ▶ Select the probe function by pressing the **PROBING ROT** soft key
- ▶ Rotation angle: If you wish to restore the current basic rotation later, note the value that appears under Rotation Angle
- ▶ Perform a basic rotation with the workpiece edge to be compared  
**Further information:** "Compensating workpiece misalignment with 3-D touch probe (option 17)", page 669
- ▶ Probe the second edge in the same way as for a basic rotation, but do not set the rotation angle to 0
- ▶ Press the **ROTATION PROBING** soft key to display the angle PA between the workpiece edges as the rotation angle
- ▶ Cancel the basic rotation, or restore the previous basic rotation by setting the rotation angle to the value that you wrote down previously

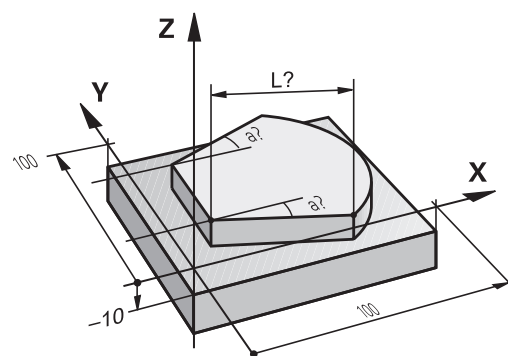

## 16.11 Tilting the working plane (option 8)

### Application, function



Refer to your machine manual.

The **Tilt working plane** functions are interfaced to the control and the machine tool by the machine tool builder.

The machine tool builder also specifies whether the programmed angles are interpreted as coordinates of the rotary axes (axis angles) or as angular components of a tilted plane (spatial angles).

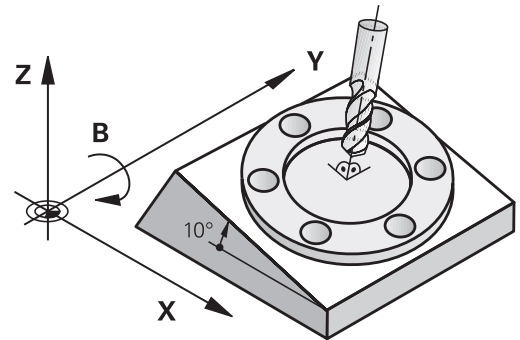

The control supports the tilting functions on machine tools with swivel heads and/or tilting tables. Typical applications are, for example, oblique holes or contours in an oblique plane. The working plane is always tilted around the active datum. The program is written as usual in a main plane, such as the X/Y plane, but is executed in a plane that is tilted relative to the main plane.

There are three functions available for tilting the working plane:

- Manual tilting with the **3-D ROT** soft key in the **Manual operation** and **Electronic handwheel** modes  
**Further information:** "Activating manual tilting:", page 690
- Controlled tilting, Cycle **19 WORKING PLANE** in the machining program  
**Further information:** Cycle Programming User's Manual
- Controlled tilting, **PLANE** function in the machining program  
**Further information:** "The PLANE function: Tilting the working plane (option 8)", page 535

The control functions for tilting the working plane are coordinate transformations. The working plane is always perpendicular to the direction of the tool axis.

When tilting the working plane, the control differentiates between two machine types:

■ **Machine with tilting table**

- You must tilt the workpiece into the desired position for machining by positioning the tilting table, for example with an L block.
- The position of the transformed tool axis **does not change** in relation to the machine coordinate system. Thus if you rotate the table—and therefore the workpiece—by 90° for example, the coordinate system **does not rotate**. If you press the Z+ axis direction button in the **Manual operation** mode, the tool moves in Z+ direction.
- In calculating the transformed coordinate system, the control considers only the mechanically influenced offsets of the particular tilting table (the translational components).

■ **Machine with swivel head**

- You must tilt the workpiece into the desired position for machining by positioning the swivel head, for example with an L block
- The position of the transformed tool axis changes in relation to the machine coordinate system. Thus if you rotate the swivel head of your machine—and therefore the tool—in the B axis by 90° for example, the coordinate system rotates also. If you press the Z+ axis direction button in the **Manual operation** mode, the tool moves in the X+ direction of the machine coordinate system.
- In calculating the active coordinate system, the control considers both the mechanically influenced offsets of the particular swivel head (the translational components) as well as offsets caused by tilting of the tool (3-D tool length compensation).



The control only supports the **Tilt working plane** function in combination with the spindle axis Z.



### Position display in a tilted system

The positions displayed in the status window (**ACTL.** and **NOML.**) are referenced to the tilted coordinate system.

In the optional machine parameter **CfgDisplayCoordSys** (no. 127501) you can specify the coordinate system in which the status display shows an active datum shift.

### Limitations on working with the tilting function

- The **Actual-position capture** function is not allowed if the Tilt working plane function is active
- PLC positioning (determined by the machine tool builder) is not possible.

## Activating manual tilting:

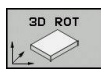

- ▶ To select manual tilting, press the **3-D ROT** soft key.



- ▶ Use the arrow keys to move the cursor to the menu point **Manual operation**



- ▶ To activate manual tilting, press the **ACTIVE** soft key



- ▶ Use the arrow keys to position the cursor on the desired rotary axis

- ▶ Enter the tilt angle

- ▶ Terminate the entry: Press the **END** key

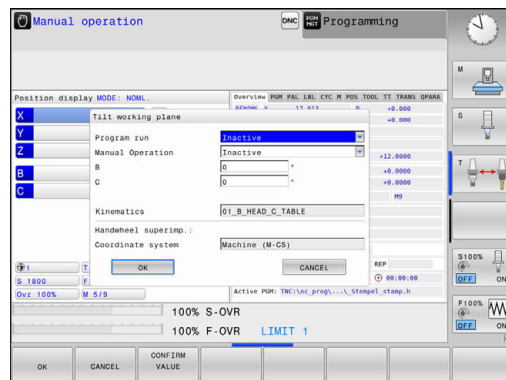

If the tilted working plane function is active and the control moves the machine axes in accordance with the tilted axes, the status display shows the  symbol.

If you set the "Tilt working plane" function for the **Program run** operating mode to **Active**, the tilt angle entered in the menu becomes active in the first block of the machining program. If you use Cycle **19 WORKING PLANE** or the **PLANE** function in the machining program, the angle values defined there are in effect. Angle values entered in the menu will be overwritten.



The control uses the following **transformation types** for tilting:

- **COORD ROT**
  - if a **PLANE** function was previously executed with **COORD ROT**
  - after **PLANE RESET**
  - with corresponding configuration of the machine parameter **CfgRotWorkPlane** (no. 201200) by the machine tool builder
    - after starting the control
    - after switching the kinematics
    - after running the cycle **19 WORKING PLANE**
- **TABLE ROT**
  - if a **PLANE** function was previously executed with **TABLE ROT**
  - with corresponding configuration of the machine parameter **CfgRotWorkPlane** (no. 201200) by the machine tool builder
    - after starting the control
    - after switching the kinematics
    - after running the cycle **19 WORKING PLANE**



If tilting was active when the control was turned off, then the control also moves in the tilted working plane when it is turned on again.

**Further information:** "Crossing the reference point in a tilted working plane", page 623

### To deactivate manual tilting

To deactivate, set the appropriate operating modes to **Inactive** in the **Tilt working plane** menu.

Even if the **3D-ROT** dialog in the **Manual operation** mode is set to **Active**, resetting the tilting (**PLANE RESET**) with an active basic transformation still functions correctly.

## Setting the tool-axis direction as the active machining direction



Refer to your machine manual.  
Your machine manufacturer enables this function.

Using this function in the **Manual operation** and **Electronic handwheel** operating modes, you can move the tool in the direction in which the tool axis is currently pointed using the axis direction keys or with the handwheel. Use this function if

- You want to retract the tool in the direction of the tool axis during suspension of a 5-axis machining program
- You want to machine with an inclined tool using the handwheel or the axis direction keys in Manual Operation mode

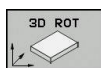

- ▶ To select manual tilting, press the **3-D ROT** soft key.



- ▶ Use the arrow keys to move the cursor to the menu item **Manual operation**



- ▶ To activate the current tool axis direction as the active machining direction, press the **Tool axis** soft key



- ▶ Terminate the entry: Press the **END** key

To deactivate the tilting function, set the **Manual operation** menu item in the "Tilt working plane" menu to inactive.

The  symbol appears in the status display when the Move in tool axis direction function is active.

## Setting a preset in a tilted coordinate system

After you have positioned the rotary axes, set the preset in the same manner as for a non-tilted system. The behavior of the control during presetting depends on the setting in the optional machine parameter **chkTiltingAxes** (no. 204601):

**Further information:** "Introduction", page 654

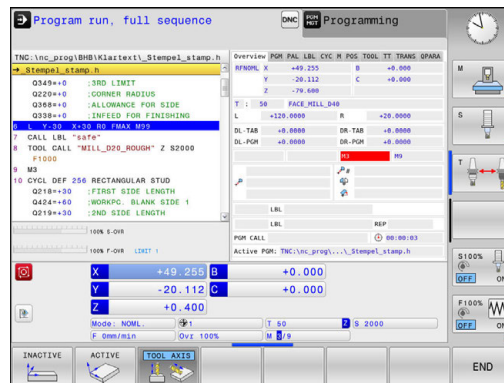

# 17

**Positioning with  
Manual Data Input**

## 17.1 Programming and executing simple machining operations

The **Positioning w/ Manual Data Input** mode of operation is particularly convenient for simple machining operations or for pre-positioning the tool. It enables you to write a short program, depending on machine parameter **programInputMode** (no. 101201), in Klartext or in ISO format and execute it immediately. The program is stored in the file \$MDI.

You can use the following functions for example:

- Cycles
- Radius compensation
- Program section repetitions
- Q parameters

The additional status display can be activated in the **Positioning w/ Manual Data Input** mode of operation.

### NOTICE

#### Danger of collision!

Certain manual interactions cause the control to lose program information affecting the mode and thereby to lose the so-called contextual reference. After the loss of the contextual reference, unexpected and undesired movements can occur. There is a danger of collision during subsequent machining operations!

- ▶ Do not perform the following interactions:
  - Cursor movement to another NC block
  - The jump command **GOTO** to another NC block
  - Editing an NC block
  - Modifying Q parameter values with the **Q INFO** soft key
  - Switching the operating modes
- ▶ Restore the contextual reference via repetition of the required NC blocks

## Positioning with manual data input (MDI)



- ▶ Select the **Positioning w/ Manual Data Input** operating mode
- ▶ Program the desired available function



- ▶ Press the **NC Start** key
- ▶ The control executes the highlighted NC block.  
**Further information:** "Programming and executing simple machining operations", page 694



Operating and programming notes:

- The following functions are not available in the **Positioning w/ Manual Data Input** operating mode:
  - FK free contour programming
  - Program call
    - **PGM CALL**
    - **SEL PGM**
    - **CALL SELECTED PGM**
  - Programming graphics
  - Program-run graphics
- Using the **SELECT BLOCK** and **CUT OUT BLOCK** soft keys etc. you can also conveniently and rapidly reuse program sections from other NC programs.  
**Further information:** "Marking, copying, cutting and inserting program sections", page 165
- You can control and modify Q parameters with the soft keys **Q PARAMETER LIST** and **Q INFO**.  
**Further information:** "Checking and changing Q parameters", page 378

**Example**

A hole with a depth of 20 mm is to be drilled into a single workpiece. After clamping and aligning the workpiece and setting the preset, you can program and execute the drilling operation with a few lines of programming.

First you pre-position the tool above the workpiece with straight-line blocks and position with a safety clearance of 5 mm above the hole. Then drill the hole with Cycle **200 DRILLING**.

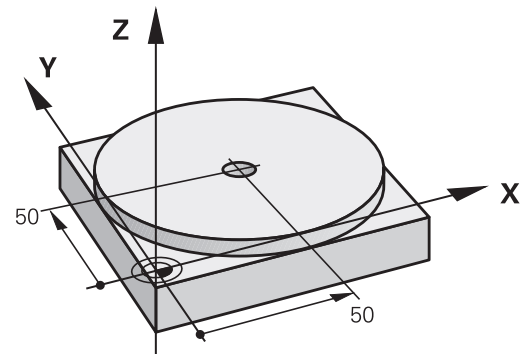

<b>0 BEGIN PGM \$MDI MM</b>	
<b>1 TOOL CALL 1 Z S2000</b>	Call the tool: tool axis Z, spindle speed 2000 rpm
<b>2 L Z+200 R0 FMAX</b>	Retract the tool (F MAX = rapid traverse)
<b>3 L X+50 Y+50 R0 FMAX M3</b>	Move the tool at F MAX to a position above the hole, spindle on
<b>4 CYCL DEF 200 DRILLING</b>	Define the DRILLING cycle
<b>Q200=5 ;SET-UP CLEARANCE</b>	Set-up clearance of the tool above the hole
<b>Q201=-20 ;DEPTH</b>	Hole depth (algebraic sign=working direction)
<b>Q206=250 ;FEED RATE FOR PLNGNG</b>	Feed rate for drilling
<b>Q202=5 ;PLUNGING DEPTH</b>	Depth of each infeed before retraction
<b>Q210=0 ;DWELL TIME AT TOP</b>	Dwell time after every retraction in seconds
<b>Q203=-10 ;SURFACE COORDINATE</b>	Coordinate of the workpiece surface
<b>Q204=20 ;2ND SET-UP CLEARANCE</b>	Set-up clearance of the tool above the hole
<b>Q211=0.2 ;DWELL TIME AT DEPTH</b>	Dwell time in seconds at the hole bottom
<b>Q395=0 ;DEPTH REFERENCE</b>	Depth referenced to the tool tip or the cylindrical part of the tool
<b>5 CYCL CALL</b>	Call the DRILLING cycle
<b>6 L Z+200 R0 FMAX M2</b>	Retract the tool
<b>7 END PGM \$MDI MM</b>	End of program

Straight-line function:

**Further information:** "Straight line L", page 289



### Example : Remove workpiece misalignment on a machine with a rotary table

- ▶ Use a 3-D touch probe to carry out a basic rotation  
**Further information:** "Compensating workpiece misalignment with 3-D touch probe (option 17)", page 669
- ▶ Write down the rotation angle and cancel the basic rotation



- ▶ Select the operating mode: Press the **Positioning w/ Manual Data Input** key



- ▶ Select the rotary table axis, enter the rotation angle and feed rate you wrote down, e.g. **L C +2.561 F50**



- ▶ Conclude entry



- ▶ Press the **NC Start** button: The rotation of the table corrects the misalignment

### Protecting programs in \$MDI

The \$MDI file is intended for short programs that are only needed temporarily. Nevertheless, you can store a program, if necessary, by proceeding as described below:



- ▶ Operating mode: Press the **Programming** key



- ▶ To call the file manager, press the **PGM MGT** key.



- ▶ Move the highlight to the **\$MDI** file

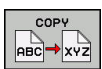

- ▶ To copy the file: Press the **COPY** soft key

### DESTINATION FILE =

- ▶ Enter the name under which you want to save the current contents of the \$MDI file, e.g. **Hole**

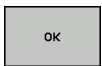

- ▶ Press the **OK** soft key.



- ▶ To exit the file manager, press the **END** soft key

**Further information:** "Copying a single file", page 176



# 18

**Test Run and  
Program Run**

## 18.1 Graphics (option 20)

### Application

In the **Program run, single block** and **Program run, full sequence** operating modes, as well as in the **Test Run** Operating Mode, the control graphically simulates a machining operation.

The control features the following views:

- Plan view
- Projection in three planes
- 3-D view



In the **Test Run** operating mode, you can additionally use the 3-D line graphics.

The graphic depicts the workpiece as if it were being machined with a cylindrical end mill.

For active tool tables, the control also takes the entries in the columns LCUTS, T-ANLGE, and R2 into consideration.

The control will not show a graphic if

- the current program has no valid workpiece blank definition
- no program is selected
- with blank form definition with a subprogram, the BLK FORM block was not yet run



The simulation of programs with 5-axis machining or tilted machining might run at reduced speed. With the MOD menu **Graphic settings** you can decrease the **Model quality** and in that way increase the speed of simulation.



If you are using a TNC 620 with touch control, you can replace some keystrokes with hand-to-screen contact.

**Further information:** "Operating the Touchscreen", page 123

### Graphics without Option 20 Advanced Graphic Features

Without option 20, no model is available in the **Program run, single block** and **Program run, full sequence** operating modes nor in the **Test Run** operating mode.

The **PROGRAM + GRAPHICS** and **GRAPHICS** soft keys are dimmed.





The line graphic in **Programming** operating mode also functions without option 20.

### Speed of the setting test runs



The most recently set speed stays active until a power interruption. After the control is switched on the speed is set to FMAX.

After you have started a program, the control displays the following soft keys with which you can set the simulation speed:

Soft key	Functions
	Test program with the speed that will be used when actually running the program (programmed feed rates will be taken into account)
	Increase the simulation speed incrementally
	Decrease the simulation speed incrementally
	Test run at the maximum possible speed (default setting)

You can also set the simulation speed before you start a program:





- ▶ Select the function for setting the simulation speed



- ▶ Select the desired function by soft key, e.g. incrementally increasing the simulation speed

## Overview: Display modes



In the **Program run, single block** and **Program run, full sequence** operating modes, as well as in **Test Run** operating mode, the control displays the following soft keys:

Soft key	View
	Plan view
	Projection in three planes
	3-D view



The position of the soft keys depends on the selected operating mode.

The **Test Run** mode of operation also offers the following views:

Soft key	View
	Volume view
	Volume view and tool paths
	Tool paths

### Limitations during program run



The simulation may contain errors if the control's computing capacity is being fully utilized for complex machining tasks.

### 3-D view

Choose 3-D view:

The high-resolution 3-D view enables you to display the surface of the machined workpiece in greater detail. Using a simulated light source, the control creates realistic light and shadow conditions.

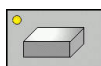

- ▶ Press the 3-D view soft key

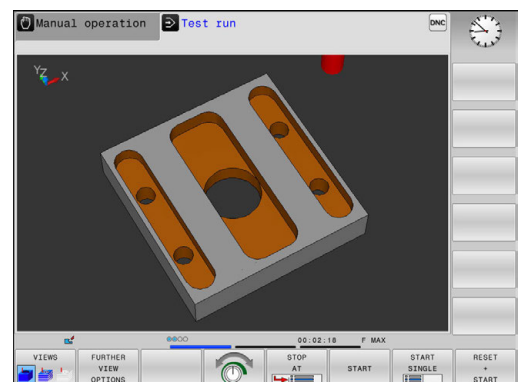

**Rotating, enlarging and shifting the 3-D view**

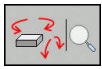

- ▶ Select functions for rotating and zooming
- > The control displays the following soft keys.

Soft keys	Function
	Rotate in 5° steps about the vertical axis
	Tilt in 5° steps about the horizontal axis
	Enlarge the graphic stepwise
	Reduce the graphic stepwise
	Reset the graphic to its original size and angle
	▶ Scroll through the soft-key row



Soft keys	Function
	Move the graphic upward or downward
	Move the graphic to the left or right
	Reset the graphic to its original position and angle

You can also use the mouse to change the graphic display. The following functions are available:











- ▶ In order to rotate the model shown in three dimensions, hold down the right mouse button and move the mouse. If you simultaneously press the shift key, you can only rotate the model horizontally or vertically
- ▶ To shift the model shown: Hold the center mouse button or mouse wheel down and move the mouse. If you simultaneously press the shift key, you can only shift the model horizontally or vertically
- ▶ To zoom in on a certain area: Mark a zoom area by holding the left mouse button down.
- > After you release the left mouse button, the control zooms in on the defined area.
- ▶ To rapidly magnify or reduce any area: Rotate the mouse wheel backwards or forwards
- ▶ To return to the standard display: Press the shift key and simultaneously double-click with the right mouse key. The rotation angle is maintained if you only double-click with the right mouse key

### 3-D view in the Test Run operating mode

The **Test Run** mode of operation also offers the following views:

Soft keys	Function
	Volume view
	Volume view and tool paths
	Tool paths

The **Test Run** operating mode also provides the following functions:

Soft keys	Function
	Show workpiece blank frame
	Highlight workpiece edges on 3-D model
	Show a transparent workpiece
	Show the end points of the tool paths
	Show the block numbers of the tool paths
	Show the workpiece in color
	Reset the volume model
	Reset the tool paths
	Display the rapid traverse movements
	<p>Activate measuring</p> <p>If measuring is activated, the control shows the corresponding coordinates in close proximity if you position the mouse cursor on the 3-D graphics of the workpiece.</p>

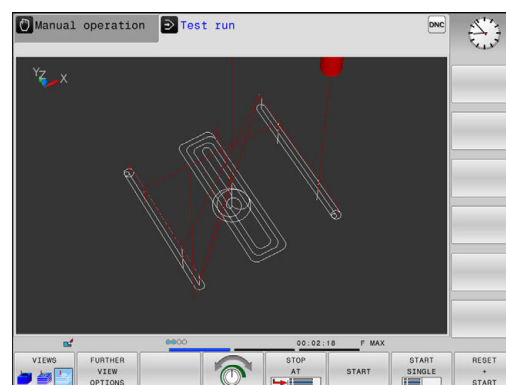
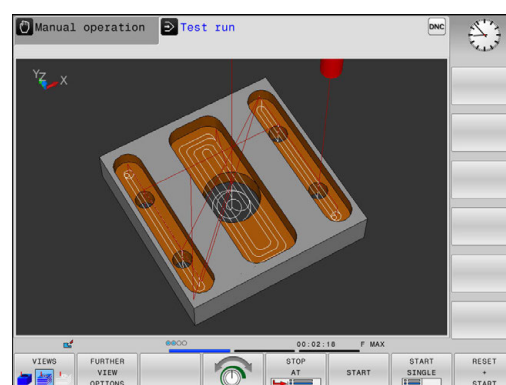
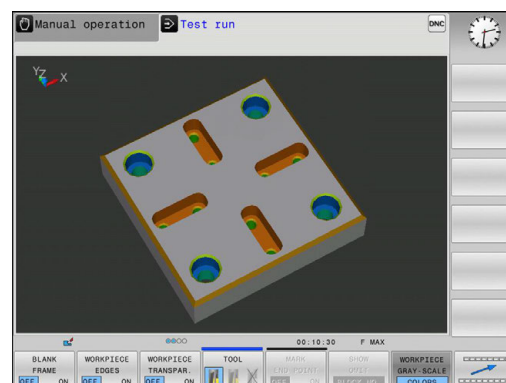



The control saves the state of the following soft keys in non-volatile memory, even after interruption of the power supply:

- Movements at rapid traverse
- Workpiece blank frame
- Workpiece edges
- Transparent workpiece
- Workpiece in color





Operating notes:



- The available functions depend on the selected model quality. You can select the model quality in the MOD function **Graphic settings**.
- With the machine parameter **clearPathAtBlk** (No. 124203), you can specify whether or not the tool path in the **Test Run** operating mode is cleared with a new BLK FORM.
- If points were output incorrectly by the postprocessor, then machining marks occur on the workpiece. To recognize these unwanted machining marks in time (prior to machining), you can test externally created NC programs for corresponding irregularities by the display of tool paths.
- A powerful zoom function is available in order for you to quickly recognize the details for the displayed tool paths.
- The control displays traverse movements in rapid traverse in red.

### Plan view

Select the plan view in the **Test Run** operating mode:

- 
  - ▶ Press the **FURTHER VIEW OPTIONS** soft key
- 
  - ▶ Press the **plan view** soft key

Select plan view in the operating modes **Program run, single block** and **Program run, full sequence**:

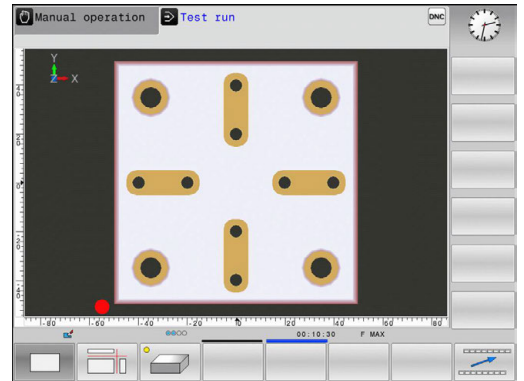

- 
  - ▶ Press the **GRAPHICS** soft key
- 
  - ▶ Press the **plan view** soft key





### Projection in three planes

The simulation shows three sectional planes and a 3-D model, similar to a technical drawing.

Select projection in three planes in the **Test Run** operating mode:

- 
  - ▶ Press the **FURTHER VIEW OPTIONS** soft key
- 
  - ▶ Press the **View on 3 Planes** soft key

Select projection in three planes in the operating modes **Program run, single block** and **Program run, full sequence**:

- 
  - ▶ Press the **GRAPHICS** soft key
- 
  - ▶ Press the **View on 3 Planes** soft key

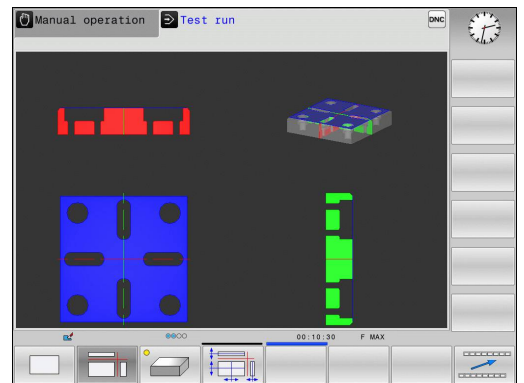

### Moving sectional planes

The default setting of the sectional plane is selected so that it lies in the working plane in the workpiece center and in the tool axis on the top surface.

Shift the sectional plane as follows:

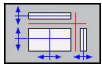

- ▶ Press the soft key for **shifting the sectional plane**
- > The control displays the following soft keys:

Soft keys	Function
	Shift the vertical sectional plane to the right or left
	Shift the vertical sectional plane forward or backward
	Shift the horizontal sectional plane upwards or downwards

The position of the sectional planes is visible during shifting. The shift remains active, even if you activate a new workpiece blank.

### Resetting sectional planes

The shifted sectional plane also remains active for a new workpiece blank. The sectional plan is automatically reset when the control is restarted.

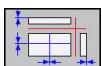

You can also move the sectional plane to its default position manually:



- ▶ Press the soft key for **resetting the sectional planes** soft key



## Repeating graphic simulation

A part program can be graphically simulated as often as desired. To do so you can reset the graphic to the workpiece blank.

Soft key	Function
	Display the unmachined blank in the <b>Program run, single block</b> and <b>Program run, full sequence</b> operating modes
	Display the unmachined blank in the <b>Test Run</b> operating mode

## Tool display

Regardless of the operating mode, you can also show the tool during the simulation.

Soft key	Function
	<b>Program run, full sequence / Program run, single block</b>
	<b>Test Run</b>

The control displays the tool in various colors:

- Red: Tool is in effect
- Blue: Tool is retracted

## Measurement of machining time

### Machining time in the Test Run operating mode

The control calculates the duration of the tool movements and displays this as machining time in the test run. The control takes feed movements and dwell times into account.

The time determined by the control is only of limited value for calculating the machining time because it does not take any machine-dependent time intervals (e.g., for tool changes) into consideration.

### Machining time in the machine operating modes

Time display from program start to program end. The timer stops whenever machining is interrupted.

### Selecting the stopwatch function





- ▶ Shift the soft key menu until the soft key for the stopwatch functions appears



- ▶ Select the stopwatch function



- ▶ Select the desired function via soft key, e.g., saving the displayed time

Soft key	Stopwatch functions
	Store displayed time
	Display the sum of stored time and displayed time
	Clear displayed time

## 18.2 Showing the workpiece blank in the working space (option 20)

### Application

In the **Test Run** operating mode, you can graphically check the position of the workpiece blank and the preset in the working space of the machine. The graphics show the preset that has been set in the NC program using Cylce 247. If you have not set a preset in the NC program, then the graphics show the active preset on the machine.









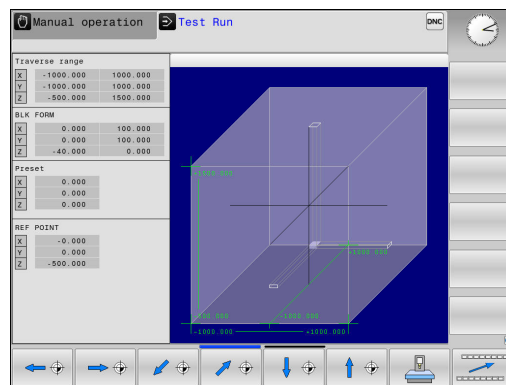

You can active workspace monitoring in the **Test Run** operating mode: to do so, press the **BLANK IN WORK SPACE** soft key. You can activate or deactivate the function using the **SW limit monitoring** soft key.

A transparent cuboid represents the workpiece blank. Its dimensions are shown in the **BLK FORM** table. The control takes over the dimensions from the workpiece blank definition of the selected program.

For a test run it normally does not matter where the workpiece blank is located within the working space. If you activate workspace monitoring, you must graphically shift the workpiece blank so that it lies within the working space. Use the soft keys shown in the table.

You can also activate the current preset for the **Test Run** operating mode.



Soft keys	Function
 	Shift workpiece blank in positive/negative X direction
 	Shift workpiece blank in positive/negative Y direction
 	Shift workpiece blank in positive/negative Z direction
	Show workpiece blank referenced to the set preset
	Display the current traverse range
	This shows the traverse ranges configured by the machine tool builder and can be selected accordingly.
	Switch monitoring function on or off
	Display machine reference point







Operating notes:

- With **BLK FORM CYLINDER**, a cuboid is depicted as the workpiece blank in the working space
- With **BLK FORM ROTATION**, no workpiece blanks is depicted in the working space

## 18.3 Functions for program display

### Overview

In the **Program Run Single Block** and **Program Run Full Sequence** operating modes, the control displays the following soft keys for displaying the NC program in pages:

Soft key	Functions
	Go back one screen in the NC program
	Go forward one screen in the NC - program
	Select start of program
	Select end of program



## 18.4 Test run

### Application

In the **Test Run** operating mode, you can simulate programs and program sections in order to reduce NC programming errors when programs are running. The control checks the programs for the following:

- Geometrical incompatibilities
- Missing data
- Impossible jumps
- Violation of the machine's working space
- Using disabled tools

The following functions are also available:

- Blockwise test run
- Interruption of test at any block
- Optional block skip
- Functions for graphic simulation
- Measure machining time
- Additional status display

#### Keep the following in mind when performing a test run

With cuboid workpiece blanks, the control starts a test run after a tool call at the following position:

- In the working plane in the center of the defined **BLK FORM**
- In the tool axis, 1 mm above the **MAX** point defined in the **BLK FORM**

With rotationally symmetrical workpiece blanks, the control starts a test run after a tool call at the following position:

- In the machining plane at the position  $X=0, Y=0$
- In the tool axis 1 mm above the defined workpiece blank

### NOTICE

#### Danger of collision!

In the **Test Run** operating mode, the control does not take all axis movements of the machine into consideration (e.g., PLC positioning movements as well as movements from tool-change macros and M functions). This can cause a test performed without errors to later deviate from the machining operation. Danger of collision during machining!

- ▶ Test the NC program at the later machining position (**BLANK IN WORK SPACE**)
- ▶ Program a safe intermediate position after the tool change and before repositioning
- ▶ Carefully test the NC program in the **Program run, single block** operating mode



Refer to your machine manual.

Your machine tool builder can also define a tool-change macro for the **Test Run** operating mode. This macro will simulate the exact behavior of the machine.

In doing so, the machine tool builder often changes the simulated tool change position.



### Test run execution

 For the test run, you must activate a tool table (status S). Select a tool table via the file manager in the **Test Run** mode of operation.





You can select any preset table (status S) for the test run. After **RESET + START**, line 0 of the temporarily loaded preset table automatically displays the currently active preset from **Preset.PR** (execution). Line 0 is selected when starting the test run until you define another preset in the NC program. All presets from lines > 0 are read by the control from the selected preset table of the test run.

With the **BLANK IN WORK SPACE** function, you can activate workspace monitoring for the test run.

**Further information:** "Showing the workpiece blank in the working space (option 20)", page 710

-  ▶ Operating mode: Press the **Test Run** key
-  ▶ Call the file manager with the **PGM MGT** key and select the file you wish to test

**The control then displays the following soft keys:**

Soft key	Functions
	Reset the blank form, reset the previous tool data and test the entire program
	Test the entire program
	Test each NC block individually
	Executes the <b>Test Run</b> until block N
	Stop test run (this soft key only appears if you have started the test run)

You can interrupt and continue the test run at any time, even within fixed cycles. In order to continue the test, the following actions must not be performed:

- Selecting another block with the arrow keys or the **GOTO** key
- Making changes to the program
- Selecting a new program

## Test Run up to a certain block

With the **STOP AT** function the control executes a **Test Run** up to the block with block number **N**.

Proceed as follows to stop the **Test Run** at any block:



- ▶ Press the **STOP AT** soft key
- ▶ **Stop at: N** = Enter the block number at which the simulation should stop
- ▶ **Program** = Enter the name of the program containing the block with the selected block number
- ▶ The control shows the name of the selected program.
- ▶ If the simulation is to be stopped in a program that has been called using **PGM CALL**, then enter this name
- ▶ **Repetitions** = If **N** is located in a program section repeat, enter the number of repeats that you want to run.  
Default 1: The control stops before **N** is simulated

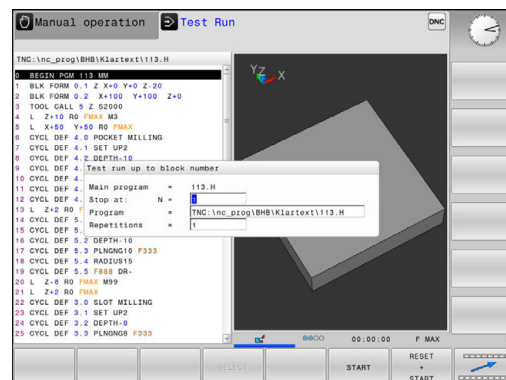

## Possibilities in stopped condition

If you interrupt the **Test Run** with the **STOP AT** function, you have the following possibilities in this stopped condition:

- **Block skip** enable or disable
- **Optional program stop** enable or disable
- Modify graphics resolution and model
- Modify the NC program in the **Programming** operating mode

If you modify the NC program in the **Programming** operating mode the simulation behaves as follows:

- Modification before the interruption point: The simulation restarts at the beginning
- Modification after the interruption point: Positioning at the interruption point is possible with **GOTO**

## 18.5 Program run

### Application

In the **Program run, full sequence** operating mode, the control executes a machining program continuously to its end or up to a program stop.

In the **Program run, single block** operating mode, the control executes each block individually after pressing the **NC Start** key. With point pattern cycles and **CYCL CALL PAT** the controls stops after each point.

You can use the following control functions in the **Program run, single block** and **Program run, full sequence** operating modes:

- Interrupt program run
- Starting the program run from a certain block
- Optional block skip
- Edit the tool table TOOL.T
- Checking and changing Q parameters
- Superimpose handwheel positioning
- Functions for graphic simulation
- Additional status display

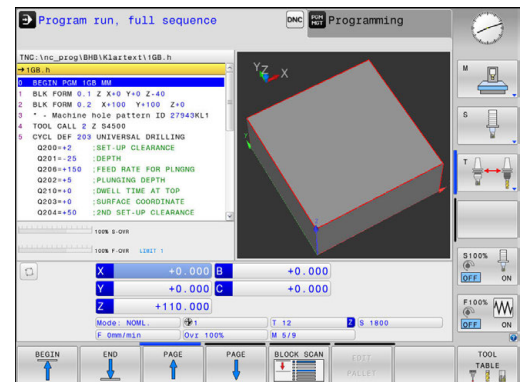

## Running a part program

### Preparation

- 1 Clamp the workpiece to the machine table.
- 2 Set the preset
- 3 Select the necessary tables and pallet files (status M)
- 4 Select the part program (status M)



#### Operating notes:

- You can change the feed rate and spindle speed using the potentiometers.
- You can reduce the feed rate using the **FMAX** soft key. This reduction affects all rapid traverse and feed movements, even after the control has been restarted.

### Program Run, Full Sequence

- ▶ Start the machining program with the **NC Start** key

### Program Run, Single Block

- ▶ Start each block of the machining program individually with the **NC Start** key

## Interrupting, stopping or aborting machining

There are several ways to stop a program run:

- Interrupt the program run with e.g. the miscellaneous function **M0**
- Interrupt the program run e.g. with the miscellaneous function **M0**
- Stop the program run e.g. with the **NC stop** key in connection with the **INTERNAL STOP** soft key
- Terminate the program run e.g. with the miscellaneous functions **M2** or **M30**

The control shows the current status of the program run in the status display.

**Further information:** "General status display", page 94

In contrast to a stopped run, an interrupted, aborted (terminated) program run enables certain actions by the user, including the following:

- Select operating mode
- Check Q parameters and change these if necessary using the **Q INFO** function
- Change setting for the optional programmed interruption with **M1**
- Change setting for the programmed skipping of NC blocks with **/**



During major errors, the control automatically aborts the program run (e.g., during a cycle call with stationary spindle).

### Program-controlled interruptions

You can set interruptions directly in the NC program. The control interrupts the program run in the NC Block containing one of the following inputs:

- Programmed stop **STOP** (with and without miscellaneous function)
- Programmed stop **M0**
- Conditional stop **M1**

## NOTICE

### Danger of collision!

Certain manual interactions cause the control to lose program information affecting the mode and thereby to lose the so-called contextual reference. After the loss of the contextual reference, unexpected and undesired movements can occur. There is a danger of collision during subsequent machining operations!

- ▶ Do not perform the following interactions:
  - Cursor movement to another NC block
  - The jump command **GOTO** to another NC block
  - Editing an NC block
  - Modifying Q parameter values with the **Q INFO** soft key
  - Switching the operating modes
- ▶ Restore the contextual reference via repetition of the required NC blocks



Refer to your machine manual.

The miscellaneous function **M6** may also lead to a suspension of the program run. The machine manufacturer sets the functional scope of the miscellaneous functions.



### Manual program interruption

While a machining program is being executed in the **Program run, full sequence** operating mode, select the **Program run, single block** operating mode. The control interrupts the machining process at the end of the current machining step.

#### Abort program run.

- ▶ Press **NC Stop** key



- > The control does not exit the current NC block
- > The control shows the symbol for stopped status in the status display
- > Actions such as a change of operating mode are not possible
- > The program can be resumed with the **NC Start** key

- ▶ Press the **INTERNAL STOP** soft key



- > The control briefly shows the symbol for aborting the program in the status display



- > The control shows the symbol for the exited inactive status in the status display
- > Actions such as a change of operating mode are available again

## Moving the machine axes during an interruption

You can move the machine axes during an interruption in the same way as in the **Manual operation** mode.

### NOTICE

#### Danger of collision!

During a program interruption, the axes can be moved manually (e.g., in order to retract out of a drilled hole. If, at the time of the interruption, the **Tilt the working plane** function is active, then the **3D ROT** soft key becomes available. The **3D ROT** function can be used to deactivate the tilted working place or to limit manual traverse exclusively to the active tool axis. A risk of collision exists for incorrect **3D ROT** settings!

- ▶ It is better to use the **TOOL AXIS** function
- ▶ Use a low feed rate

## Modifying the preset during an interruption

If you modify the active preset during an interruption, resuming the program run is only possible with **GOTO** or mid-program startup at the interruption point.

### Example:

#### Retracting the spindle after tool breakage

- ▶ Interrupt machining
- ▶ Enable the axis direction keys: Press the **MANUAL TRAVERSE** soft key
- ▶ Move the machine axes with the axis direction keys



On some machines you may have to press the **NC start** key after the **MANUAL TRAVERSE** soft key to enable the axis direction keys. Refer to your machine manual.

## Resuming program run after an interruption

The control saves the following data during a program interruption:

- The last tool that was called
- Current coordinate transformations (e.g., datum shift, rotation, mirroring)
- The coordinates of the circle center that was last defined

The control uses the stored data for returning the tool to the contour after manual machine axis positioning during an interruption (**RESTORE POSITION** soft key).



Operating notes:

- The saved data remains active until it is reset (e.g., by selecting a program).
- If you interrupt an NC program using the **INTERNAL STOP** key, then you must start machining at the start of the program or by using the **BLOCK SCAN** function.
- For program interruptions within program section repeats or subprograms, re-entering at the point of interruption must be done using the **BLOCK SCAN** function.
- With machining cycles, mid-program startup is always executed at the start of the cycle. If you interrupt a program run during a machining cycle, the control repeats machining steps already carried out after a block scan.

## Resuming the program run with the NC Start key

You can resume program run by pressing the machine **START** button if the program was interrupted in one of the following ways:

- Press the **NC Stop** key
- Programmed interruption

## Resuming program run after an error

With an erasable error message:

- ▶ Remove the cause of the error
- ▶ Clear the error message from the screen: Press the **CE** key
- ▶ Restart the program, or resume program run where it was interrupted

## Retraction after a power interruption



Refer to your machine manual.  
Your machine tool builder configures and enables the **Retract** operating mode.

With the **Retraction** mode of operation you can disengage the tool from the workpiece after an interruption in power.

If you activated a feed rate limit before a power failure, this is still active. You can deactivate the feed-rate limit using the **CANCEL THE FEED RATE LIMITATION** soft key.

The **Retraction** mode of operation is selectable in the following conditions:

- Power interrupted
- No control voltage for the relay
- Traverse reference points

The **Retraction** operating mode offers the following modes of traverse:

Mode	Function
Machine axes	Movement of all axes in the machine coordinate system
Tilted system	Movement of all axes in the active coordinate system Effective parameters: Position of the tilting axes
Tool axis	Movements of the tool axis in the active coordinate system
Thread	Movements of the tool axis in the active coordinate system with compensating movement of the spindle Effective parameters: Thread pitch and direction of rotation



If the **Tilt the working plane** function (option 8) is enabled on your control, then the **Tilted system** traverse mode is also available.

The control selects the mode of traverse and the associated parameters automatically. If the traverse mode or the parameters have not been correctly preselected, you are unable to reset them manually.

**NOTICE**

**Caution: Danger to the tool and workpiece!**

A power failure during the machining operation can cause uncontrolled “coasting” or braking of the axes. In addition, if the tool was in effect prior to the power failure, then the axes cannot be referenced after the control has been restarted. For non-referenced axes, the control takes over the last saved axis values as the current position, which can deviate from the actual position. Thus, subsequent traverse movements do not correspond to the movements prior to the power failure. If the tool is still in effect during the traverse movements, then the tool and the workpiece can sustain damage through tension!

- ▶ Use a low feed rate
- ▶ Please keep in mind that the traverse range monitoring is not available for non-referenced axes

**Example**

The power failed while a thread cutting cycle in the tilted working plane was being performed. You have to retract the tap:

- ▶ Switch on the power supply for control and machine
- > The control starts the operating system. This process may take several minutes.
- > The control will then display the **Power interrupted** message in the screen header.

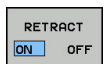

- ▶ Activate the **Retraction** mode: Press the **RETRACT** soft key
- > The control displays the message **Retraction selected**



- ▶ Confirm the power interruption: Press the **CE** key
- > The control compiles the PLC program.



- ▶ Switch on the machine control voltage
- > The control checks the functioning of the EMERGENCY STOP circuit. If there is at least one non-referenced axis, you will have to compare the displayed position values with the actual axis values and confirm that they are correct. if required, follow the dialog.

- ▶ Check the preselected traverse mode: If required, select **THREAD**
- ▶ Check the preselected thread pitch: if required, enter the thread pitch
- ▶ Check the preselected direction of rotation: if needed, select the turning direction of the thread  
 Right-handed thread: the main spindle turns clockwise when moving into the workpiece, counter-clockwise when retracting from it; left-handed thread: main spindle turns counter-clockwise when moving into the workpiece and clockwise when retracting from it



- ▶ Activate retraction: Press the **RETRACT** soft key

- ▶ Retraction: Retract the tool with the axis direction keys or the electronic handwheel  
Axis key Z+: Retraction from the workpiece  
Axis key Z-: Moving into the workpiece



- ▶ Exit retraction: Return to the original soft-key level

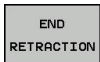

- ▶ End the **Retraction** mode: Press the **END RETRACTION** soft key
- > The control checks whether the **Retraction** mode can be ended. If necessary, follow the dialog.
- ▶ Answer confirmation request: If the tool was not correctly retracted, press the **NO** soft key. If the tool was correctly retracted, press the **YES** soft key.
- > The control hides **Retraction selected** mode.
- ▶ Initialize the machine: if required, cross the reference points
- ▶ Establish the desired machine condition: If required, reset the tilted working plane

## Entering the program at any point: Mid-program startup



Refer to your machine manual.

The **BLOCK SCAN** function must be enabled and configured by the machine tool manufacturer.

With the **BLOCK SCAN** function you can start an NC program at any desired NC block. The control factors workpiece machining up to this NC block into the calculations.

If the NC program was interrupted under the following conditions, the control saves the interruption point:

- **INTERNAL STOP** soft key
- Emergency stop
- Power failure

If, while restarting, the control finds a saved point of interruption, then it outputs a message. You can then execute mid-program startup directly at the point of interruption.

You can run the mid-program startup in the following ways:

- Mid-program startup in the main program, with repetitions if necessary
- Multi-level mid-program startup in subprograms and touch probe cycles
- Mid-program startup in a point table
- Block scan in pallet programs

At the start of mid-program startup the control resets all data, as with a selection of the NC program. During the mid-program startup, you can switch between **Program Run Full Sequence** and **Program Run Single Block**.

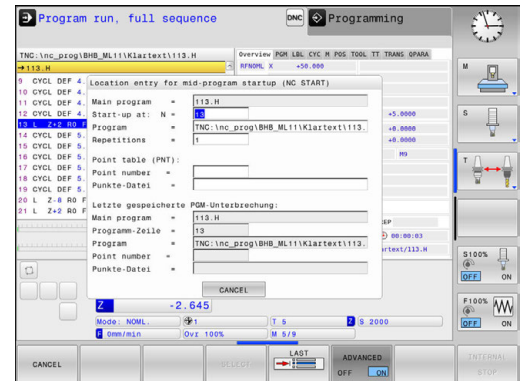

### NOTICE

#### Danger of collision!

The **BLOCK SCAN** function skips over the programmed touch probe cycles. As a result, the result parameters contain no values or, possibly, incorrect values. If the subsequent machining operation uses these result parameters, then there is a risk of collision!

- ▶ Use the **BLOCK SCAN** function at multiple levels  
**Further information:** "Procedure for multi-level mid-program startup", page 729



The **BLOCK SCAN** function must not be used in conjunction with the following functions:

- Active stretch filter
- Touch probe cycles 0, 1, 3, and 4 during the search phase of mid-program startup

### Procedure for simple mid-program startup



The control only displays the dialogs required by the process in the pop-up window.

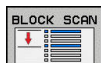

- ▶ Press the **BLOCK SCAN** soft key
- > The control shows a pop-up window with the active main program.
- ▶ **Start-up at: N** = Enter the number of the NC block where you wish to enter the NC program
- ▶ **Program** = Check the name and path of the NC program containing the NC block, or enter with the **SELECT** soft key
- ▶ **Repetitions** = Enter the number of repetitions which should be taken into account in the block scan if the NC block is located within a program section repetition.  
**Default 1 means initial machining operating**

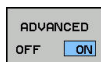

- ▶ Press the **ADVANCED** soft key if required

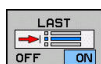

- ▶ if required, press the **INSERT LAST NC BLOCK** soft key to select the last saved interruption



- ▶ Press the **NC Start** key
- > The control starts the block scan, calculates until the entered NC block and shows the next dialog.

If you changed the machine status:



- ▶ Press the **NC Start** key
- > The control restores the machine status, e.g. TOOL CALL, M functions and shows the next dialog.

If you changed the axis positions:



- ▶ Press the **NC Start** key
- > The control approaches the specified positions in the specified sequence and shows the next dialog.  
Approach axes in individually selected sequence:  
**Further information:** "Returning to the contour", page 733



- ▶ Press the **NC Start** key
- > The control resumes execution of the NC program.

### Example of simple mid-program startup

After an internal stop, you would like to start in block 12 in the third machining operation of LBL 1.

In the pop-up window enter the following data:

- **Start-up at: N** =12
- **Repetitions** = 3



### Procedure for multi-level mid-program startup

If you, for example, start in a subprogram that is called several times by the main program, then use the multi-level mid-program startup. For this purpose, jump in the main program to the desired subprogram call. With the **CONTINUE BLOCK SCAN** function, you can jump further from this position.



Operating notes:

- The control only displays the dialogs required by the process in the pop-up window.
- You can also continue the **BLOCK SCAN** without restoring the machine status and the axis position of the first startup point. For this, press the **CONTINUE BLOCK SCAN** soft key before confirming the restoration with the **NC-Start** key.

Mid-program startup to the first start-up point:

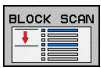

- ▶ Press the **BLOCK SCAN** soft key
- ▶ Enter the first NC block where you wish to start
- ▶ Press the **ADVANCED** soft key if required



- ▶ If required, press the **INSERT LAST NC BLOCK** soft key in order to select the last saved interruption



- ▶ Press the **NC Start** key
- ▶ The control starts the block scan and calculates until the entered NC block.

If the control should restore the machine status of the entered NC block:



- ▶ Press the **NC Start** key
- ▶ The control restores the machine status, e.g. TOOL CALL, M functions.

If the control should restore the axis positions:



- ▶ Press the **NC Start** key
- ▶ The control moves in the specified sequence to the specified positions.

If the control should run the NC block:



- ▶ Select the **Program Run Single Block** operating mode if required



- ▶ Press the **NC Start** key
- ▶ The control runs the NC block.

Mid-program startup to the next start-up point:



- ▶ Press the **CONTINUE BLOCK SCAN** soft key
- ▶ Enter the NC block where you wish to start

If you changed the machine status:



- ▶ Press the **NC Start** key

If you changed the axis positions:



- ▶ Press the **NC Start** key

If the control should run the NC block:



- ▶ Press the **NC Start** key
- ▶ Repeat these steps if required to jump to the next start-up point



- ▶ Press the **NC Start** key
- ▶ The control resumes execution of the NC program.

### Example of multi-level mid-program startup

You run a main program with several subprogram calls in the program Sub.h. You work with a touch probe cycle in the main program. You use the result of the touch probe cycle later for positioning.

After an internal stop you wish to start up in block 8 in the second call of the subprogram. This subprogram call is in block 53 of the main program. The touch probe cycle is in block 28 of the main program, i.e. before the desired start-up point.

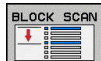

- ▶ Press the **BLOCK SCAN** soft key
- ▶ In the pop-up window enter the following data:
  - **Start-up at: N =28**
  - **Repetitions = 1**



- ▶ Select the **Program Run Single Block** operating mode if required



- ▶ Press the **NC start** key until the control runs the touch probe cycle
- ▶ The control saves the result.



- ▶ Press the **CONTINUE BLOCK SCAN** soft key
- ▶ In the pop-up window enter the following data:
  - **Start-up at: N =53**
  - **Repetitions = 1**



- ▶ Press the **NC start** key until the control runs the NC block
- ▶ The control jumps into the subprogram Sub.h.



- ▶ Press the **CONTINUE BLOCK SCAN** soft key
- ▶ In the pop-up window enter the following data:
  - **Start-up at: N =8**
  - **Repetitions = 1**



- ▶ Press the **NC start** key until the control runs the NC block
- ▶ The control continues to run the subprogram and then returns to the main program.

### Block scan in a point table

If you start in a point table called by the main program, use the **ADVANCED** soft key.

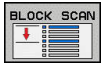

- ▶ Press the **BLOCK SCAN** soft key
- > The control shows a pop-up window.

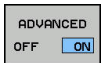

- ▶ Press the **ADVANCED** soft key
- > The control expands the pop-up window.
- ▶ **Point number =** enter the line number of the point table you start with
- ▶ Enter the **Point file =** name and path of the point table



- ▶ If required, press the **SELECT LAST BLOCK** soft key in order to select the last saved interruption



- ▶ Press the **NC Start** key

If you would like to start with the mid-program startup in a point pattern, then proceed just as you would for starting in the point table. Enter the desired point number in the **Point number =** input field. The first point in the point pattern has the point number **0**.

### Block scan in pallet programs

With the pallet management (option 22) you can also use the **BLOCK SCAN** function in conjunction with pallet tables.

If you interrupt the processing of pallet tables, the control always suggests the previously selected NC block of the interrupted NC program for the **BLOCK SCAN** function.



For **BLOCK SCAN** in pallet tables, you also define the **Pallet line** = input field. The input refers to the line in the **NR** pallet table. This input is always required as an NC program may appear several times in a pallet table. The **BLOCK SCAN** always takes place in a workpiece-oriented manner, even if you have selected the machining method **TO** and **CTO**. After the **BLOCK SCAN**, the control continues working again in accordance with the selected machining method.

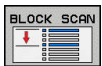

- ▶ Press the **BLOCK SCAN** soft key
- > The control shows a pop-up window.
- ▶ **Pallet line** = Enter the row number of the pallet table
- ▶ Enter **Repetitions** = if the NC block is located within a program section repetition

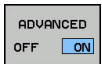

- ▶ Press the **ADVANCED** soft key if required
- > The control expands the pop-up window.



- ▶ Press the **SELECT LAST BLOCK** soft key to select the last saved interruption



- ▶ Press the **NC Start** key

## Returning to the contour

With the **RESTORE POSITION** function, the control moves the tool to the workpiece contour in the following situations:

- Return to the contour after the machine axes were moved during a program interruption that was not performed with the **INTERNAL STOP** function.
- Return to the contour with a block scan with **RESTORE POS AT N**, for example, after an interruption with **INTERNAL STOP**
- Depending on the machine, if the position of an axis has changed after the control loop has been opened during a program interruption

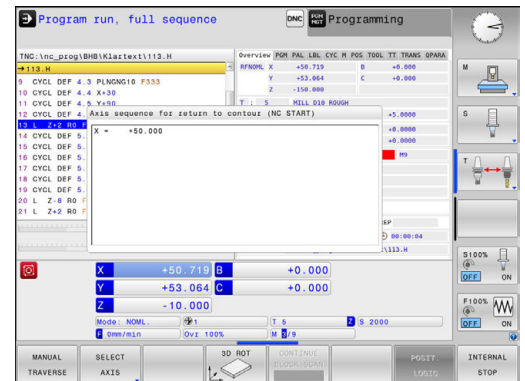

### Procedure

Proceed as follows to approach the contour:

- RESTORE POSITION**
- Press the **RESTORE POSITION** soft key
  - Restore the machine status, if required

Approach the axes in the sequence shown by the control:

-  Press the **NC Start** key

Approach the axes according to individually selected sequence:

- SELECT AXIS**
- Press the **SELECT AXIS** soft key
  - Press the axis soft key of the first axis
  - Press the **NC Start** key

- 
- Press the axis soft key of the second axis
  - Press the **NC Start** key

- 
- Repeat the process for all axes

**i** If the tool is located in the tool axis below the starting point, then the control offers the tool axis as the first traverse direction.

## 18.6 Automatic program start

### Application



Refer to your machine manual.

The control must be specially prepared by the machine tool builder for use of the automatic program start function.

### **⚠ DANGER**

#### Caution: Danger for the operator!

The **AUTOSTART** function automatically starts the machining operation. Open machines with unsecured work envelopes pose a huge danger for the machine operator.

- ▶ Use the **AUTOSTART** function exclusively on closed machines

In a Program Run operating mode, you can use the **AUTOSTART** soft key to define a specific time at which the program that is currently active in this operating mode is to be started:



- ▶ Display window for setting the starting time
- ▶ **Time (hrs:min:sec):** Time of day at which the program is to be started
- ▶ **Date (DD.MM.YYYY):** Date on which the program is to be started
- ▶ To activate the start, press the **OK**

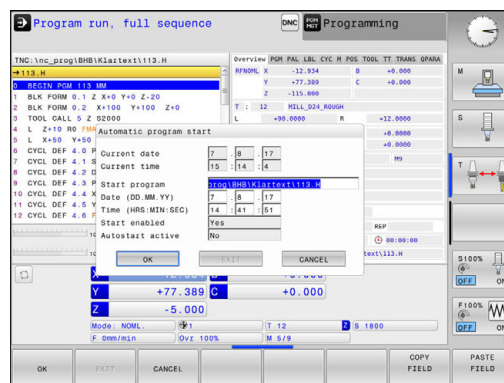

## 18.7 Skipping blocks

### Application

You can have blocks skipped in the **Test Run** or **Program Run, Full Sequence/Single Block** operating modes if you have marked these blocks with a / sign:



- ▶ In order to not execute or not test NC blocks with a / sign, set the soft key to **ON**



- ▶ To execute or test NC blocks with a / sign, set the soft key to **OFF**



Operating notes:

- This function does not work for **TOOL DEF** blocks.
- After a power interruption the control returns to the most recently selected setting.

### Delete / symbol

- ▶ In the **Programming** mode you select the block in which the character is to be added



- ▶ Press the **INSERT** soft key

### Delete / symbol

- ▶ In the **Programming** mode you select the block in which the character is to be erased



- ▶ Press the **REMOVE** soft key

## 18.8 Optional program-run interruption

### Application



Refer to your machine manual.

The behavior of this function varies depending on the respective machine.

The control optionally interrupts program run at blocks in which an M1 has been programmed. If you use M1 in the **Program run** operating mode, then the control does not switch off the spindle or the coolant.



- ▶ Do not interrupt **Program run** or **Test Run** with blocks containing M1: Set the soft key to **OFF**



- ▶ Interrupt **Program run** or **Test Run** with blocks containing M1: Set the soft key to **ON**



# 19

**MOD Functions**

## 19.1 MOD function

The MOD functions provide additional input possibilities and displays. In addition, you can enter code numbers to enable access to protected areas.

### Selecting MOD functions

Open the pop-up window with the MOD functions:

-  ▶ Press the **MOD** key
- ▶ The control opens a pop-up window displaying the available MOD functions.

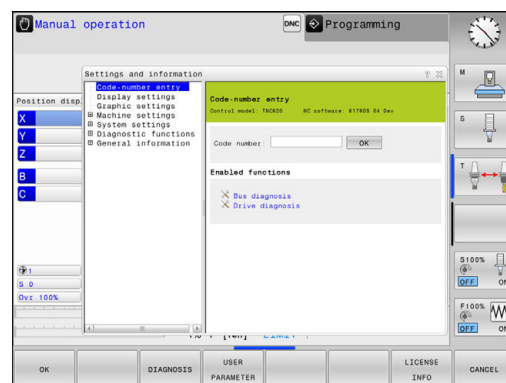

### Changing the settings

As well as with the mouse, navigation with the keyboard is also possible in the MOD functions:

- ▶ Switch from the input area in the right window to the MOD function selections in the left window with the tab key
- ▶ Select MOD function
- ▶ Switch to the input field with the tab key or ENT key
- ▶ Enter value according to function and confirm with **OK** or make selection and confirm with **Apply**



If there are multiple possible settings available, then you can show the selection box by pressing the **GOTO** key. Select the desired setting with the **ENT** key. If you do not wish to change the setting, close the window with the **END** key.

### Exiting MOD functions

- ▶ Exit the MOD functions: Press the **END** soft key or the **END** key

## Overview of MOD functions

The following functions are available independent of the selected operating mode:

### Code-number entry

- Code number

### Display settings

- Digital readouts
- Measuring unit (mm/inch) for position display
- Program entry for MDI
- Show time of day
- Show the info line

### Graphic settings

- Model type
- Model quality

### Counter settings

- Momentary count
- PGM for counter

### Machine settings

- Kinematics
- Traverse limits
- Tool-usage file
- External access
- Set up wireless handwheel
- Set up touch probes

### System settings

- Set the system time
- Define the network connection
- Network: IP configuration

### Diagnostic functions

- Bus diagnosis
- Diagnosis of Drives
- HEROS information

### General information

- Version information
- License information
- Machine times

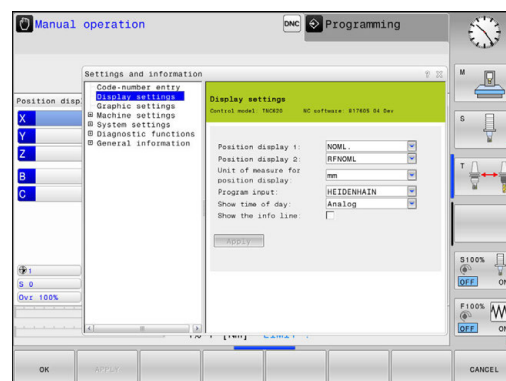

## 19.2 Graphic settings

With the MOD functions **Graphic settings** you can select the model type and model quality operating mode.



To select **Graphic settings** proceed as follows:

- ▶ Select the group **Graphic settings** from the MOD menu
- ▶ Select the model type
- ▶ Select the model quality
- ▶ Press the **APPLY** soft key
- ▶ Press the **OK** soft key.



In the **Test Run** operating mode, the control displays icons of the active **Graphic settings**.

You have the following simulation parameters for the control's **Graphic settings**:

### Model type

Icon	Choice	Properties	Application
	3-D	Very true to detail, heavy time and processor consumption	Milling with undercuts,
	2.5 D	Fast	Milling without undercuts
	No model	Very fast	Line graphics

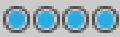
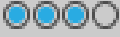
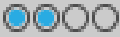
### Model quality

Icon	Choice	Properties
	Very high	High data transfer rate, exact depiction of tool geometry, depiction of block end points and block numbers possible
	High	High data transfer rate, exact depiction of tool geometry
	Medium	Medium data transfer rate, approximation of tool geometry
	Low	Low data transfer rate, coarse approximation of tool geometry

### 19.3 Counter settings



With the MOD function **Counter settings**, you can change the current count (actual value) and the target value (nominal value).

Proceed as follows to select the **Counter settings**:

- ▶ In the MOD menu, select the **Counter settings** group
- ▶ Select the current count
- ▶ Select the target value for the counter
- ▶ Press the **APPLY** soft key
- ▶ Press the **OK** soft key

The control immediately takes over the selected value in the status display

You can change the **Counter settings** via soft key as follows:

Soft key	Meaning
	Reset count
	Increase count
	Lower count

You can also enter the values directly with a connected mouse.

**Further information:** "Defining a counter", page 512

## 19.4 Machine settings

### External access



Refer to your machine manual.

The machine tool builder can configure the external access options.

Depending on the machine, you can grant or restrict access for an external diagnostics or commissioning software application using the **TNCOPT** soft key.

With the MOD function **External access**, you can grant or restrict access to the control. Once you have restricted external access, it is no longer possible to connect to the control and to exchange data over a network or over a serial connection (e.g., with the TNCremo data transfer software).

Proceed as follows to restrict external access:

- ▶ In the MOD menu, select the **Machine settings** group
- ▶ Select the **External access** menu
- ▶ Set the **EXTERNAL ACCESS ON/OFF** soft key to **OFF**
- ▶ Press the **OK** soft key

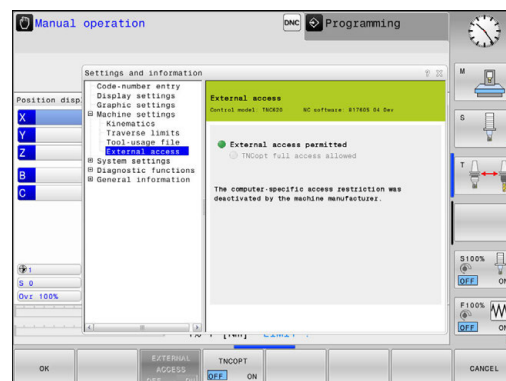

**Computer-specific access control**

If your machine manufacturer has set up computer-specific access control (machine parameter **CfgAccessControl** no. 123400), you can permit access for up to 32 connections authorized by you. Select **Add** to create a new connection. The control then opens an input box for you to enter the connection data.

**Access settings**

Host name	Host name of the external computer
Host IP	Network address of the external computer
Description	Additional information (text is shown in the overview list)

**Type:**

Ethernet	Network connection
Com 1	Serial interface 1
COM 2	Serial interface 2

**Access rights:**

Inquire	For external access, the control opens a query dialog
Deny	Do not permit network access
Permit	Permit network access without query

If you assign the **Inquire** access right to a connection, and if access is gained from this address, then the control opens a pop-up window. You must permit or deny external access in the pop-up window:

External access	Permission
Yes	Permit once
Always	Permit continuously
Never	Deny continuously
No	Deny once

**i** In the overview list, an active connection is shown with a green symbol.  
Connections without access rights are shown gray in the overview list.

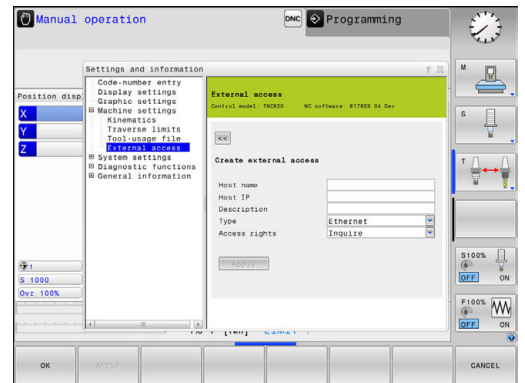

## Entering traverse limits



Refer to your machine manual.  
Your machine tool builder configures and enables the **Traverse limits** function.

The MOD function **Traverse limits** enables you to limit the actually usable tool path within the maximum traverse range. This enables you to define protection zones on each axis in order, for example, to protect a component from collision.

To enter traverse limits:

- ▶ In the MOD menu, select the **Machine settings** group
- ▶ Select the **Traverse limits** menu
- ▶ Enter the values of the desired axes as a reference value or load the momentary position with the **actual position capture** soft key
- ▶ Press the **APPLY** soft key
- ▶ The control checks the entered values for validity.
- ▶ Press the **OK** soft key



Operating notes:

- The protection zone becomes active automatically as soon as you have set a valid traverse limit in an axis. The settings are kept even after the control has been restarted.
- You can only deactivate the protection zone by deleting all values or pressing the **EMPTY EVERYTHING** soft key.

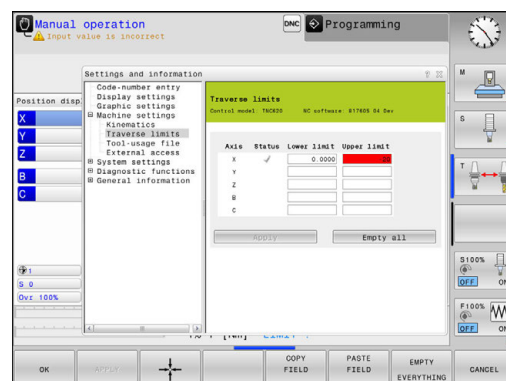



## Tool usage file



Refer to your machine manual.  
The tool usage test function must be enabled by your machine tool builder.

With the MOD function **Tool-usage file**, you can select whether the control never, once, or always creates a tool usage file.

Generate a tool usage file:

- ▶ In the MOD menu, select the **Machine settings** group
- ▶ Select the **Tool-usage file** menu
- ▶ Select the desired setting for the **Program Run, Full Sequence/ Single Block** and **Test Run** operating modes
- ▶ Press the **APPLY** soft key
- ▶ Press the **OK** soft key

## Select kinematics



Refer to your machine manual.  
Your machine tool builder configures and enables the **Kinematics selection** function.

### NOTICE

#### Danger of collision!

All stored kinematics can also be selected as active machine kinematics. By this means, all manual movements and machining operations are executed using the selected kinematics. All subsequent axis movements pose a risk of collision!

- ▶ Use the **Kinematics selection** function only in the **Test Run** operating mode
- ▶ Use the **Kinematics selection** function for selecting the active machine kinematics only as needed

You can use this function to test programs whose kinematics does not match the active machine kinematics. If your machine manufacturer saved different kinematic configurations in your machine, you can activate one of these kinematics configurations with the MOD function. When you select a kinematics model for the test run this does not affect machine kinematics.



Ensure that you have selected the correct kinematics in the Test Run operating mode for checking your workpiece.

## 19.5 System settings

### Set the system time

With the **Set the system time** MOD function you can set the time zone, date and time manually or with the aid of an NTP server synchronization.

Proceed as follows to set the system time:

- ▶ In the MOD menu, select the **System settings** group
- ▶ Press the **SET DATE/ TIME** soft key
- ▶ In the **Time zone** area, select the desired time zone
- ▶ Press the **NTP on** soft key in order to select the **Set the time manually** entry
- ▶ Change the date and time as needed
- ▶ Press the **OK** soft key

To set the system time with the aid of an NTP server:

- ▶ In the MOD menu, select the **System settings** group
- ▶ Press the **SET DATE/ TIME** soft key
- ▶ In the **Time zone** area, select the desired time zone
- ▶ Press the **NTP off** soft key in order to select the **Synchronize the time over NTP server** entry
- ▶ Enter hostnames or the URL of an NTP server
- ▶ Press the **Add** soft key
- ▶ Press the **OK** soft key

## 19.6 Select the position display

### Application



You can influence the display of the coordinates for the operating mode **Manual operation** and the operating modes **Program run, full sequence** and **Program run, single block**.

The figure on the right shows the different tool positions:

- Initial position
- Target position of the tool
- Workpiece datum
- Machine datum

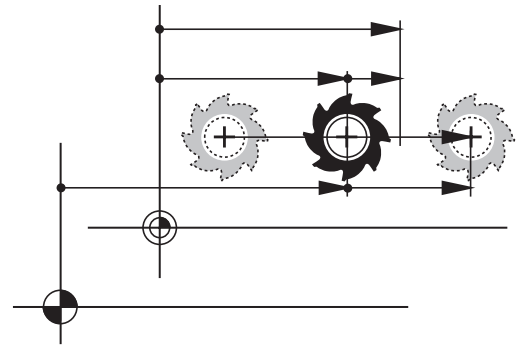
You can select the following coordinates for the control's position displays:



Display	Function
NOML	Nominal position: The value currently commanded by the control
	<div style="border: 1px solid black; padding: 5px;">  The NOML and ACTL displays differ solely with regard to following error.                 </div>
ACTL	Actual position; current tool position
	<div style="border: 1px solid black; padding: 5px;">  Refer to your machine manual. Your machine tool builder defines whether the ACTL and NOML display deviates from the programmed position by the DL oversize of the tool call.                 </div>
REF ACTL	Reference position; actual position relative to the machine datum
REF NOML	Reference position; nominal position relative to the machine datum
LAG	Servo lag; difference between nominal and actual positions

Display	Function
ACTDST	<p>Distance remaining to the programmed position in the input coordinate system; difference between actual and target positions</p> <p>Examples with Cycle 11:</p> <ul style="list-style-type: none"> <li>▶ Scaling factor 0.2</li> <li>▶ L IX+10</li> <li>&gt; The ACTDST display shows 10 mm.</li> <li>&gt; The scaling factor does not have any influence.</li> </ul> <p>Example with Cycle 11 and tilled working plane:</p> <ul style="list-style-type: none"> <li>▶ Tilt A by 45°</li> <li>▶ Scaling factor 0.2</li> <li>▶ L IX+10</li> <li>&gt; The ACTDST display shows 10 mm.</li> <li>&gt; The scaling factor and the tilt do not have any influence.</li> </ul>
REFDST	<p>Distance remaining to the programmed position in the machine coordinate system; difference between actual and target positions</p> <p>Examples with Cycle 11</p> <ul style="list-style-type: none"> <li>▶ Scaling factor 0.2</li> <li>▶ L IX+10</li> <li>&gt; The REFDST display shows 2 mm.</li> <li>&gt; The scaling factor has an effect on the distance and thus on the display.</li> </ul> <p>Example with Cycle 11 and tilled working plane:</p> <ul style="list-style-type: none"> <li>▶ Tilt A by 45°</li> <li>▶ Scaling factor 0.2</li> <li>▶ L IX+10</li> <li>&gt; The REFDST display shows 1.4 mm in the X and Z axes.</li> <li>&gt; The scaling factor and the tilt have an effect on the distance and thus on the display.</li> </ul>
M118	<p>Traverse paths that were executed with handwheel superimpositioning function (<b>M118</b>)</p>

With the MOD function **Position display 1**, you can select the position display in the status display.

With the MOD function **Position display 2**, you can select the position display in the additional status display.

## 19.7 Setting the unit of measure

### Application

With this MOD function, you can determine whether the control coordinates are displayed in millimeters or inches.

- Metric system: e.g. X = 15.789 (mm), the value is displayed to 3 decimal places
- Inch system: e.g. X = 0.6216 (inches), value is displayed to 4 decimal places

If you would like to activate the inch display, the control shows the feed rate in inch/min. In an inch program you must enter the feed rate larger by a factor of 10.

## 19.8 Displaying operating times

### Application

The **MACHINE TIME** MOD function enables you to see various types of operating times:

Operating time	Meaning
<b>Control on</b>	Operating time of the control since being put into service
<b>Machine on</b>	Operating time of the machine tool since being put into service
<b>Program run</b>	Duration of controlled operation since being put into service



Refer to your machine manual.  
The machine tool builder can provide further operating time displays.

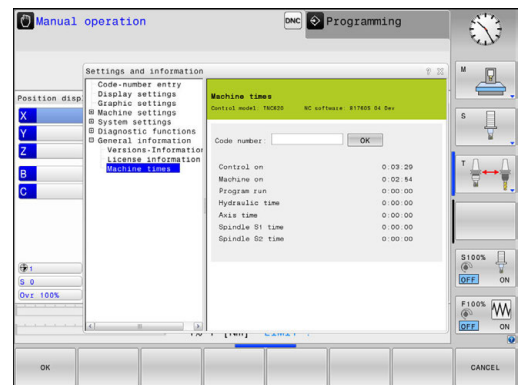

## 19.9 Software numbers

### Application

The following software numbers are displayed on the control's screen after the **Software version** MOD function has been selected:

- **Control model:** Designation of the control (managed by HEIDENHAIN)
- **NC SW:** Number of the NC software (managed by HEIDENHAIN)
- **NCK:** Number of the NC software (managed by HEIDENHAIN)
- **PLC:** Number or name of the PLC software (managed by your machine manufacturer)

In the **FCL Information** MOD function, the control shows the following information:

- **Development level (FCL=Feature Content Level):**  
Development level of the software installed on the control  
**Further information:** "Feature Content Level (upgrade functions)", page 12

## 19.10 Enter the code number

### Application

The control requires a code number for the following functions:

Function	Code number
Select user parameters	123
Configuring an Ethernet card	NET123
Enabling special functions for Q parameter programming	555343

## 19.11 Setting up data interfaces

### Serial interfaces on the TNC 620

The TNC 620 automatically uses the LSV2 transmission protocol for serial data transfer. The LSV2 protocol is prescribed and cannot be modified apart from setting the baud rate (machine parameter **baudRateLsv2**, no. 106606). You can also define another type of data transfer (interface). The settings described below are therefore effective only for the respective newly defined interface.

### Application

To set up a data interface, press the **MOD** key. Enter the code number 123. In the **CfgSerialInterface** (no. 106700) machine parameter, you can enter the following settings:

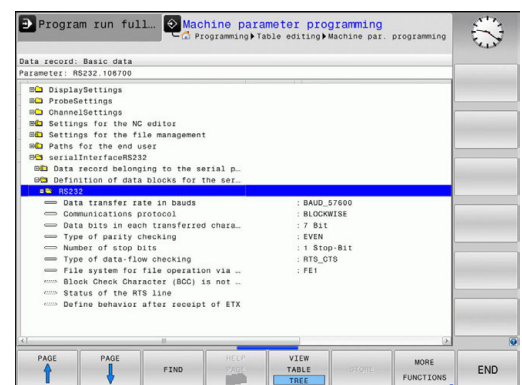

### Setting the RS-232 interface

Open the RS232 folder. The control then displays the following settings:

#### Set BAUD RATE (baud rate no. 106701)

You can set the BAUD RATE (data transfer speed) from 110 to 115 200 baud.

## Set protocol (protocol no. 106702)

The data transfer protocol controls the data flow of a serial transmission (comparable to MP5030 of the iTNC 530).



Operating notes:

- The **BLOCKWISE** setting designates a type of data transfer in which the data is transferred grouped in blocks.
- The **BLOCKWISE** setting does **not** correspond to the data reception in blocks nor to the simultaneous execution of older contouring controls in blocks. This function is no longer available for current controls.

Data transmission protocol	Selection
Standard data transmission (transmission line-by-line)	STANDARD
Packet-based data transfer	BLOCKWISE
Transmission without protocol (only character-by-character)	RAW_DATA

## Set data bits (dataBits no. 106703)

By setting the data bits you define whether a character is transmitted with 7 or 8 data bits.

## Check parity (parity no. 106704)

The parity bit helps the receiver to detect transmission errors. The parity bit can be formed in three different ways:

- No parity (NONE): There is no error detection
- Even parity (EVEN): Here there is an error if the receiver finds that it has received an odd number of set bits
- Odd parity (ODD): Here there is an error if the receiver finds that it has received an even number of set bits

## Set stop bits (stopBits no. 106705)

The start bit and one or two stop bits enable the receiver to synchronize each transmitted character during serial data transmission.



### Set handshake (flowControl no. 106706)

By handshaking, two devices control data transfer between them. A distinction is made between software handshaking and hardware handshaking.

- No data flow checking (NONE): Handshaking is not active
- Hardware handshaking (RTS\_CTS): Transmission stop is active through RTS
- Software handshaking (XON\_XOFF): Transmission stop is active through DC3 (XOFF)

### File system for file operation (fileSystem no. 106707)

In **fileSystem** you define the file system for the serial interface. This machine parameter is not required if you don't need a special file system.

- EXT: Minimum file system for printers or non-HEIDENHAIN transmission software. It corresponds to the EXT1 and EXT2 operating modes on older HEIDENHAIN controls.
- FE1: Communication with the TNCserver PC software or an external floppy disk unit.

### Block check character (bccAvoidCtrlChar no. 106708)

With Block Check Character (optional) no control character, you determine whether the checksum can correspond to a control character.

- TRUE: The checksum does not correspond to a control character
- FALSE: The checksum can correspond to a control character

### Condition of RTS line (rtsLow no. 106709)

With the state of the RTS line (optional), you can define whether the **LOW** level is active in idle state.

- TRUE: Level is **LOW** in idle state
- FALSE: Level is not **LOW** in idle state

### Define behavior after receipt of ETX (noEotAfterEtx no. 106710)

With define behavior after reception of ETX (optional) you determine whether the EOT character is sent after the ETX character was received.

- TRUE: The EOT character is not sent
- FALSE: The EOT character is sent

### Settings for the transmission of data using PC software TNCserver

Apply the following settings in machine parameter **RS232** (no. 106700):

Parameters	Selection
Data transfer rate in baud	Has to match the setting in TNCserver
Data transmission protocol	BLOCKWISE
Data bits in each transferred character	7 bits
Type of parity checking	EVEN
Number of stop bits	1 stop bit
Specify type of handshake:	RTS_CTS
File system for file operations	FE1

## Setting the operating mode of the external device (fileSystem)



The **load all programs**, **load offered program**, and **load directory** functions are not available in the **FE2** and **FEX** operating modes.

Icon	External device	Operating mode
	PC with HEIDENHAIN TNCremo data transfer software	LSV2
	HEIDENHAIN floppy disk units	FE1
	Non-HEIDENHAIN devices such as printers, scanners, punchers, PC without TNCremo	FEX

## Software for data transfer

For data transfer to or from the control, you should use the HEIDENHAIN TNCremo software. With TNCremo, data transfer is possible with all HEIDENHAIN controls via the serial interface or the Ethernet interface.



You can download the current version of the **TNCremo** software from the HEIDENHAIN homepage.

System requirements for TNCremo:

- PC with 486 processor or higher
- Windows XP, Windows Vista, Windows 7, Windows 8 operating system
- 16 MB RAM
- 5 MB free memory space on your hard disk
- An available serial interface or connection to the TCP/IP network

### Installation under Windows

- ▶ Start the SETUP.EXE installation program with the file manager (Explorer)
- ▶ Follow the setup program instructions

### Starting TNCremo under Windows

- ▶ Click on <Start>, <Programs>, <HEIDENHAIN Applications>, <TNCremo>

When you start TNCremo for the first time, it automatically tries to set up a connection with the control.

### Data transfer between the control and TNCremo

Check whether the control is connected to the correct serial port on your PC or to the network.

Once you have started TNCremo, you will see a list of all files that are stored in the active directory in the upper section of the main window **1**. Using <File>, <Change directory>, you can select any drive or another directory on your PC.

If you want to control data transfer from the PC, establish the connection with your PC in the following manner:

- ▶ Select <File>, <Setup connection>. TNCremo now receives the file and directory structure from the control and displays this in the lower part of the main window **2**
- ▶ To transfer a file from the control to the PC, select the file in the control window per mouse click and move the highlighted file into the PC window while holding down the mouse button **1**
- ▶ To transfer a file from the PC to the control, select the file in the PC window per mouse click and move the highlighted file into the control window while holding down the mouse button **2**

If you want to control data transfer from the control, establish the connection with your PC in the following manner:

- ▶ Select <Extras>, <TNCserver>. TNCremo then starts in server mode and can receive data from the control or send data to the control
- ▶ You can now call the file management functions on the control by pressing the **PGM MGT** key in order to transfer the desired files

**Further information:** "Data transfer to or from an external data carrier", page 194

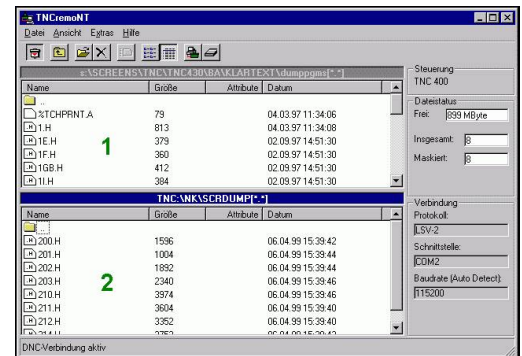

If you have exported a tool table from the control, then the tool types are converted to tool type numbers.

**Further information:** "Available tool types", page 266

### End TNCremo

Select <File>, <Exit>



You can open the context-sensitive help function of the **TNCremo** software by pressing the **F1** key.

## 19.12 Ethernet interface

### Introduction

The control is shipped with a standard Ethernet card to connect the control as a client in your network. The control transmits data via the Ethernet card with

- the **smb** protocol (Server Message Block) for Windows operating systems, or
- The **TCP/IP** protocol family (**T**ransmission **C**ontrol **P**rotocol/**I**nternet **P**rotocol) and with support from the **NFS** (**N**etwork **F**ile **S**ystem)

**i** Protect your data and your control by running your machines in a secure network.

### Connection possibility

You can connect the Ethernet card in your control to your network through the RJ45 connection (X26, 1000BaseTX, 100BaseTX and 10BaseT), or directly to a PC. The connection is metalically isolated from the control electronics.

For a 1000Base TX, 100BaseTX, and 10BaseT connection, use a twisted-pair cable to connect the control to your network.

**i** The maximum possible cable length depends on the quality grade of the cable, the sheathing, and the type of network (1000BaseTX, 100BaseTX, or 10BaseT)

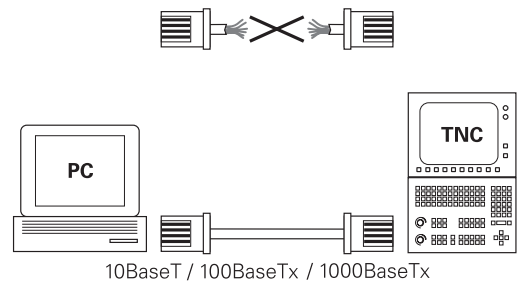

### Configuring the control

**i** Have a network specialist configure the control.

- ▶ Press the **MOD** key
- ▶ Enter the code number **NET123**
- ▶ Press the **PGM MGT** key
- ▶ Press the **NET** soft key

### General network settings

- ▶ Press the **CONFIGURE NETWORK** soft key to enter the general network settings. The **Computer name** tab is active:

Setting	Meaning
<b>Primary interface</b>	Name of the Ethernet interface to be integrated in your company network. Only active if a second, optional Ethernet interface is available on the control hardware
<b>Computer name</b>	Name displayed for the control in your company network

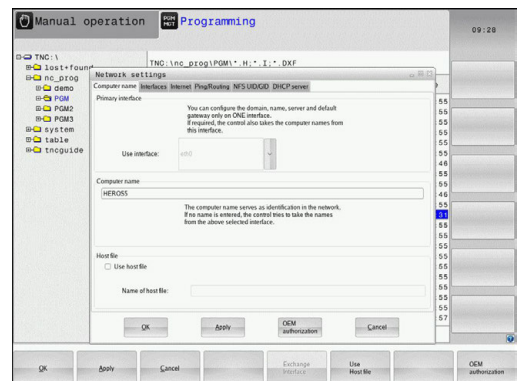

Setting	Meaning
Host file	<b>Only required for special applications:</b> Name of a file in which the assignments of IP addresses to computer names is defined

► Select the **Interfaces** tab to enter the interface settings:

Setting	Meaning
Interface list	List of the active Ethernet interfaces. Select one of the listed interfaces (via mouse or arrow keys) <ul style="list-style-type: none"> <li>■ <b>Activate</b> button: Activate the selected interface (<b>X</b> appears in the <b>Active</b> column)</li> <li>■ <b>Deactivate</b> button: Deactivate the selected interface (- appears in the <b>Active</b> column)</li> <li>■ <b>Configuration</b> button: Open the configuration menu</li> </ul>

**Allow IP forwarding** **This function must be kept deactivated.**  
Only activate this function if the optionally available second Ethernet interface should be accessed externally for diagnostic purposes via the control. Only do so after instruction by our Service Department

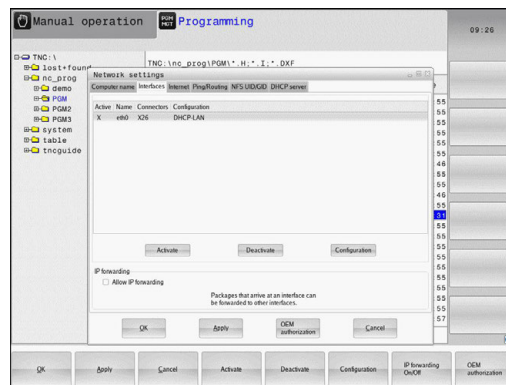

- ▶ Press the **Configuration** button to open the Configuration menu:

Setting	Meaning
<b>Status</b>	<ul style="list-style-type: none"> <li>■ <b>Interface active:</b> Connection status of the selected Ethernet interface</li> <li>■ <b>Name:</b> Name of the interface you are currently configuring</li> <li>■ <b>Plug connection:</b> Number of the plug connection of this interface on the logic unit of the control</li> </ul>
<b>Profile</b>	<p>Here you can create or select a profile in which all settings shown in this window are stored. HEIDENHAIN provides two standard profiles:</p> <ul style="list-style-type: none"> <li>■ <b>DHCP-LAN:</b> Settings for the standard Ethernet interface; should work in a standard company network</li> <li>■ <b>MachineNet:</b> Settings for the second, optional Ethernet interface; for configuration of the machine network</li> </ul> <p>Press the corresponding buttons to save, load and delete profiles</p>
<b>IP address</b>	<ul style="list-style-type: none"> <li>■ <b>Automatically procure IP address</b> option: The control is to procure the IP address from the DHCP server</li> <li>■ Option <b>Manually set IP address:</b> Manually define the IP address and subnet mask. Input: Four numerical values separated by periods, e.g. <b>160.1.180.20</b> and <b>255.255.0.0</b></li> </ul>
<b>Domain Name Server (DNS)</b>	<ul style="list-style-type: none"> <li>■ Option <b>Automatically procure DNS:</b> The control is to automatically procure the IP address of the domain name server</li> <li>■ Option <b>Manually configure the DNS:</b> Manually enter the IP addresses of the servers and the domain name</li> </ul>
<b>Default gateway</b>	<ul style="list-style-type: none"> <li>■ <b>Automatically procure default gateway</b> option: The control is to automatically procure the default gateway</li> <li>■ Option <b>Manually configure the default gateway:</b> Manually enter the IP addresses of the default gateway</li> </ul>

- ▶ Apply the changes with the **OK** button, or discard them with the **Cancel** button

- ▶ Select the tab **Internet**.

Setting	Meaning
<b>Proxy</b>	<ul style="list-style-type: none"> <li>■ <b>Direct connection to Internet / NAT:</b> The control forwards Internet inquiries to the default gateway and from there they must be forwarded through network address translation (e.g. if a direct connection to a modem is available)</li> <li>■ <b>Use proxy:</b> Define the <b>Address</b> and <b>Port</b> of the Internet router in your network, ask your network administrator for the correct address and port</li> </ul>

**Telemaintenance** The machine manufacturer configures the server for telemaintenance here. Changes must always be made in agreement with your machine tool builder

- ▶ Select the **Ping/Routing** tab to enter the ping and routing settings:

Setting	Meaning
<b>Ping</b>	<p>In the <b>Address:</b> field, enter the IP number for which you want to check the network connection. Input: four numerical values separated by periods, e.g. <b>160.1.180.20</b>. As an alternative, you can enter the name of the computer whose connection you want to check</p> <ul style="list-style-type: none"> <li>■ Press the <b>Start</b> button to begin the test. The control shows the status information in the Ping field</li> <li>■ Press the <b>Stop</b> button to conclude the test</li> </ul>

**Routing** For network specialists: Status information of the operating system for the current routing

- Press the **Update** button to refresh the routing information

- ▶ Select the **NFS UID/GID** tab to enter the user and group identifications:

Setting	Meaning
<b>Set UID/GID for NFS shares</b>	<ul style="list-style-type: none"> <li>■ <b>User ID:</b> Definition of which user identification the end user uses to access files in the network. Ask your network specialist for the proper value</li> <li>■ <b>Group ID:</b> Definition of the group identification with which you access files in the network. Ask your network specialist for the proper value</li> </ul>

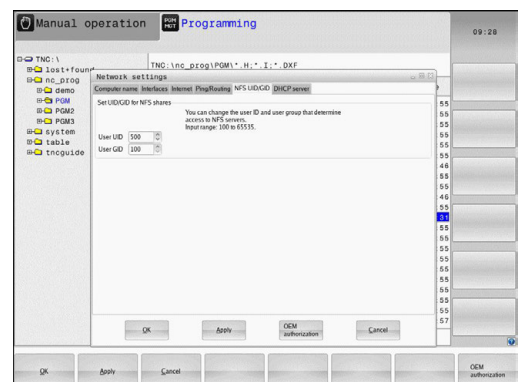
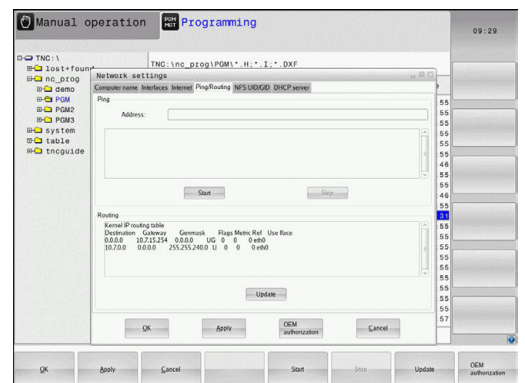
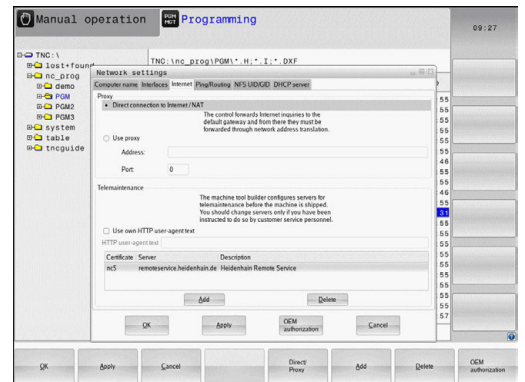



► **DHCP server:** Settings for automatic network configuration

Setting	Meaning
DHCP server	<ul style="list-style-type: none"> <li>■ <b>IP addresses from:</b> Define the IP address as of which the control is to derive the pool of dynamic IP addresses. The control transfers the values that appear dimmed from the static IP address of the defined Ethernet interface; these values cannot be edited.</li> <li>■ <b>IP addresses to:</b> Define the IP address up to which the control is to derive the pool of dynamic IP addresses.</li> <li>■ <b>Lease Time (hours):</b> Time within which the dynamic IP address is to remain reserved for a client. If a client logs on within this time, the control reassigns the same dynamic IP address.</li> <li>■ <b>Domain name:</b> Here you can define a name for the machine network if required. This is necessary if the same names are assigned in the machine network and in the external network, for example.</li> <li>■ <b>Forward DNS to external:</b> If <b>IP Forwarding</b> is active (Interfaces tab) and the option is active, you can specify that the name resolution for devices in the machine network can also be used by the external network.</li> <li>■ <b>Forward DNS from external:</b> If <b>IP Forwarding</b> is active (Interfaces tab) and the option is active, you can specify that the control is to forward DNS inquiries from devices within the machine network to the name server of the external network if the DNS server of the MC cannot answer the inquiry.</li> <li>■ <b>Status</b> button: Call an overview of the devices that are provided with a dynamic IP address in the machine network. You can also select settings for these devices.</li> <li>■ <b>Advanced options</b> button: Additional settings for the DNS/DHCP server.</li> <li>■ <b>Set standard values</b> button: Set factory settings.</li> </ul>

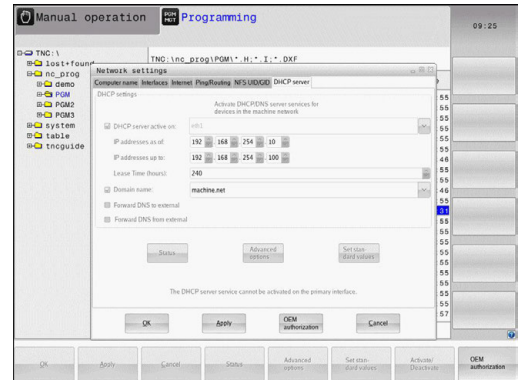

► **Sandbox:** Settings for the so-called sandbox

**i** Configure and use the sandbox on your control. For safety and security reasons, always open the browser in the sandbox.

**Network settings specific to the device**

► Press the **DEFINE NETWORK CONNECTN.** soft key to enter the network settings for a specific device. You can define any number of network settings, but you can manage only seven at one time

Setting	Meaning
<b>Network drive</b>	<p>List of all connected network drives. The control shows the respective status of the network connections in the columns:</p> <ul style="list-style-type: none"> <li>■ <b>Mount:</b> Network drive connected / not connected</li> <li>■ <b>Auto:</b> Network drive is to be connected automatically/manually</li> <li>■ <b>Type:</b> Type of network connection. cifs and nfs are possible</li> <li>■ <b>Drive:</b> Designation of the drive on the control</li> <li>■ <b>ID:</b> Internal ID that identifies if a mount point has been used for more than one connection</li> <li>■ <b>Server:</b> Name of the server</li> <li>■ <b>Share:</b> Name of the directory on the server that the control is to access</li> <li>■ <b>User:</b> User name with which the user logs on to the network</li> <li>■ <b>Password:</b> Network password protected or not</li> <li>■ <b>Query password?:</b> Query / do not query password during connection</li> <li>■ <b>Options:</b> Display additional connection options</li> </ul> <p>To manage the network drives, use the screen buttons.</p> <p>To add network drives, use the <b>Add</b> button: The control then starts the connection wizard, which guides you by dialog through the required definitions</p>

**Status log** Display of status information and error messages.

Press the Clear button to delete the contents of the Status Log window.

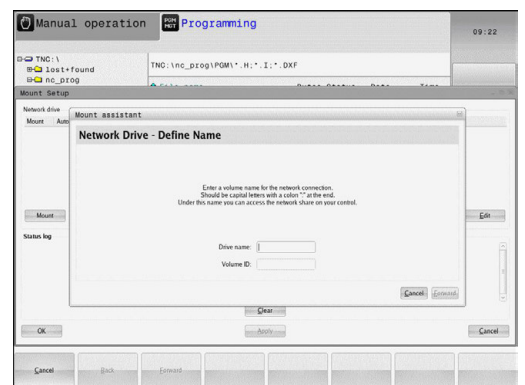
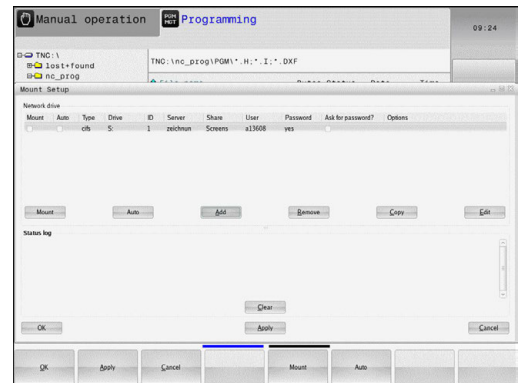



## 19.13 Firewall

### Application

You can set up a firewall for the primary network interface of the control. It can be configured so that incoming network traffic is blocked and/or a message is displayed, depending on the sender and the service. The firewall cannot be started for the second network interface of the control if it is active as the DHCP server.

Once the firewall has been activated, a symbol appears at the lower right in the taskbar. The symbol changes depending on the safety level that the firewall was activated with, and informs about the level of the safety settings:

Icon	Meaning
	Firewall protection does not yet exist although it has been activated according to the configuration. This can happen, for example, if PC names for which there are no equivalent IP addresses as yet were used in the configuration.
	Firewall active with medium security level
	Firewall active with high safety level. (All services except for the SSH are blocked)

**i** Have your network specialist check and, if necessary, change the standard settings.  
The settings in the additional tab **SSH settings** are in preparation for future enhancements and currently have no function.

### Configuring the firewall

Make your firewall settings as follows:

- ▶ Use the mouse to open the task bar at the bottom edge of the screen  
**Further information:** "Window manager", page 100
- ▶ Press the green HEIDENHAIN button to open the JH menu
- ▶ Select the **Settings** menu item
- ▶ Select the **Firewall** menu item.

HEIDENHAIN recommends activating the firewall with the prepared default settings:

- ▶ Set the **Active** option to enable the firewall
- ▶ Press the **Set standard values** button to activate the default settings recommended by HEIDENHAIN.
- ▶ Exit the dialog with the **OK** button.

## Firewall settings

Option	Meaning
Active	Switching the firewall on and off
Interface:	Selection of the <b>eth0</b> interface usually corresponds to X26 of the MC main computer. <b>eth1</b> corresponds to X116. You can check this in the network settings in the Interfaces tab. On main computer units with two Ethernet interfaces, the DHCP server is active by default for the second (non-primary) interface for the machine network. With this setting it is not possible to activate the firewall for <b>eth1</b> because the firewall and the DHCP server exclude themselves mutually
Report other inhibited packets:	Firewall active with high safety level. (All services except for the SSH are blocked)
Inhibit ICMP echo answer:	If this option is set, the control no longer responds to a PING request
Service	<p>This column contains the short names of the services that are configured with this dialog. For the configuration it is not important here whether the services themselves have been started</p> <ul style="list-style-type: none"> <li>■ <b>LSV2</b> contains the functionality for TNCremo and Teleservice, as well as the HEIDENHAIN DNC interface (ports 19000 to 19010)</li> <li>■ <b>SMB</b> only refers to incoming SMB connections, i.e. if a Windows release is made on the NC. Outgoing SMB connections (i.e. if a Windows release is connected to the NC) cannot be prevented.</li> <li>■ <b>SSH</b> stands for the Secure Shell protocol (port 22). As of HEROS 504, LSV2 can be executed securely tunneled via this SSH protocol</li> <li>■ <b>VNC</b> protocol means access to the screen contents. If this service is blocked, the screen content can no longer be accessed, not even with the TeleService programs from HEIDENHAIN (e.g. screenshot). If this service is blocked, the VNC configuration dialog shows a warning from HEROS that VNC is disabled in the firewall.</li> </ul>

Option	Meaning
Method	Under <b>Method</b> you can configure whether the service should not be available to anyone ( <b>Prohibit all</b> ), available to everyone ( <b>Permit all</b> ) or only available to some (Permit some). If you set <b>Permit some</b> you must also specify the computer (under Computer) that you wish to grant access to the respective service. If you do not specify any computer under <b>Computer</b> , the setting <b>Prohibit all</b> will automatically become active when the configuration is saved.
Log	If <b>Log</b> is activated, a <b>red</b> message is output if a network packet for this service has been blocked. A (blue) message is output if a network packet for this service was accepted.
Computer	If the setting <b>Permit some</b> is selected under <b>Method</b> , the relevant computers can be specified here. The computers can be entered with their IP addresses or host names separated by commas. If a host name is used, the system checks upon closing or saving of the dialog whether the host name can be translated into an IP address. If this is not the case, an error message is displayed and the dialog does not terminate. If a valid host name is specified, this host name is translated into an IP address each time the control is started. If a computer that was entered with its name changes its IP address, you may have to restart the control or formally change the firewall configuration to ensure that the control uses the new IP address for a host name in the firewall.
Advanced options	These settings are only intended for your network specialists
Set standard values	Resets the settings to the default values recommended by HEIDENHAIN

## 19.14 Set up touch probes

### Introduction

The control allows you to set up and manage multiple touch probes. Depending on the type of touch probe, you have the following options for setting it up:

- TT tool touch probe with radio transmission: Setup via MOD dialog
- TT tool touch probe with cable or infrared transmission: Setup via MOD dialog or entry in the machine parameters
- TS 3-D touch probe with radio transmission: Setup via MOD dialog
- 3-D TS touch probe with cable or infrared transmission: Setup via MOD dialog, tool management, or touch probe table

**Further information:** Cycle Programming User's Manual

### Setting up a touch probe with radio transmission



Refer to your machine manual.

In order for the control to recognize the touch probe with radio transmission, you will require an **SE 661** transceiver with EnDat interface.

Proceed as follows to open the setup dialog:

MOD

- ▶ Press the **MOD** key
- ▶ Select **Machine settings**
- ▶ Select **Set up touch probes**
- > The control opens the device configuration on the third desktop.

On the left side, you will see the touch probes that have already been configured. If you are unable to see all of the columns, you can shift the view with the scroll bar or shift the dividing line between the left and right sides of the screen using the mouse.

Proceed as follows to set up a touch probe with radio transmission:

- ▶ Place the cursor on the row of the **SE 661**
- ▶ Select the radio channel

CONNECT  
NEW  
TCH PROBE

- ▶ Press the **CONNECT NEW TCH PROBE** soft key
- > The control displays the next steps in the dialog
- ▶ Follow the instructions in the dialog:
  - Remove the battery from the touch probe
  - Insert the battery into the touch probe
- > The control connects to the touch probe and creates a new row in the table

## Setting up a touch probe in the MOD dialog

You can set up a 3-D touch probe with cable or with infrared transmission either in the touch probe table, in tool management, or in the MOD dialog.

You can also define tool touch probes via the machine parameter **CfgTT** (No. 122700).

Proceed as follows to open the setup dialog:

-  ▶ Press the **MOD** key
- ▶ Select the **Machine settings**
- ▶ Select **Set up touch probes**
- > The control opens the device configuration on the third desktop.

On the left side, you will see the touch probes that have already been configured. If you are unable to see all of the columns, you can shift the view with the scroll bar or shift the dividing line between the left and right sides of the screen using the mouse.

## Setting up a 3-D touch probe

Proceed as follows to set up a 3-D touch probe:

-  ▶ Press the **MAKE TT ENTRY** soft key
- > The control creates a new row in the table.
- ▶ If necessary, highlight the row with the cursor
- ▶ Enter the touch probe data on the right side
- > The control immediately saves the entered data in the touch probe table.

## Setting up a tool touch probe

Proceed as follows to set up a tool touch probe

-  ▶ Press the **MAKE TT ENTRY** soft key
- > The control opens a pop-up window.
- ▶ Enter a unique name for the touch probe
- ▶ Press **OK**
- > The control creates a new row in the table.
- ▶ If necessary, highlight the row with the cursor
- ▶ Enter the touch probe data on the right side
- > The control immediately saves the entered data in the machine parameters.

## Touch probe with radio transmission configuration

The control displays the information on the individual touch probes on the right side of the screen. Some of this information is also visible and configurable for infrared touch probes.

Tab	TS 3-D Touch Probe	TT tool touch probe
Work data	Data from the touch probe table	Data from the machine parameters
Project information	Connection data and diagnostics functions	Connection data and diagnostics functions

You can change the data from the touch probe table by selecting the row with the cursor and overwriting the current value.

You can change the machine parameters only after first entering the code number.

### Change properties

Proceed as follows to change the touch probe properties:

- ▶ Place the cursor on the row for the touch probe
- ▶ Select the "Properties" tab
- > The control shows the properties of the selected touch probe.
- ▶ Change the properties as desired per soft key

You have the following options depending on the row on which the cursor is located:

Soft key	Function
SELECT DEFLECTION	Select the probe signal
SELECT CHANNEL	Select the radio channel Select the channel with the best radio transmission and pay attention to overlaps with other machines or wireless handwheels.
CHANGE CHANNEL	Change the radio channel
REMOVE TCH. PROBE	Delete the touch probe data The control deletes the entry from the MOD dialog and the touch probe table or from the machine parameters.
EXCHANGE TCH. PROBE	Save a new touch probe in the current row The control automatically overwrites the serial number of the replaced touch probe with the new number.
SELECT SE	Select the SE transceiver
SELECT IR POWER	Select the strength of the infrared signal You only need to change the signal strength if there is interference.
SELECT RADIO POWER	Select the strength of the radio signal You only need to change the signal strength if there is interference.



The **Switching on/off** connection setting is preset based on the type of touch probe. Under **Deflection**, you can select how the touch probe is to transmit the signal when probing.

Deflection	Meaning
IR	Infrared probe signal
Radio	Radio probe signal
Radio + IR	The control selects the probe signal

You can activate the touch probe per soft key in the “Properties” tab (e.g., in order to test the radio connection)

**i** If you activate the touch probe’s radio connection manually per soft key, then the signal remains unchanged even after a tool change. You must deactivate the radio connection manually again.

**Current radio touch probe data**

The control displays the following information in the “Current radio touch probe data” area:

Display	Meaning
NO.	Number in the touch probe table
Model	Type of touch probe
Status	Touch probe active or inactive
Signal strength	Display of the signal strength in the bar graphic The control shows the currently best-known connection as a complete bar
Deflection	Stylus deflected or not deflected
Collision	Collision or no collision recognized
Battery status	Display of the battery quality If the charge is less than the displayed bar, then the control outputs a warning.

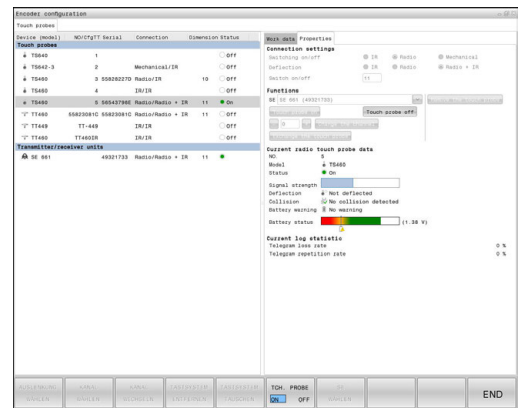

## 19.15 Configuring the HR 550FS wireless handwheel

### Application

Press the **SET UP WIRELESS HANDWHEEL** soft key to configure the HR 550FS wireless handwheel. The following functions are available:

- Assigning the handwheel to a specific handwheel holder
- Setting the transmission channel
- Analyzing the frequency spectrum for determining the optimum transmission channel
- Select transmitter power
- Statistical information on the transmission quality



Changes or modifications not expressly approved by the party responsible for compliance could void the user's authority to operate the equipment.

This device complies with Part 15 of the FCC Rules and with Industry Canada license-exempt RSS standard(s).

Operation is subject to the following two conditions:

- 1 this device may not cause harmful interference
- 2 this device must accept any interference received, including interference that may cause undesired operation

### Assigning the handwheel to a specific handwheel holder

- ▶ Make sure that the handwheel holder is connected to the control hardware.
- ▶ Place the wireless handwheel you want to assign to the handwheel holder in the handwheel holder
- ▶ Press the **MOD** key to select the MOD function
- ▶ Select the **Machine settings** menu
- ▶ Select the configuration menu for the wireless handwheel: Press the **SET UP WIRELESS HANDWHEEL** soft key
- ▶ Click on the **Connect HW** button
- ▶ The control saves serial number of the inserted wireless handwheel and shows it in the configuration window on the left next to the **Connect HW** button.
- ▶ To save the configuration and exit the configuration menu, press the **END** button

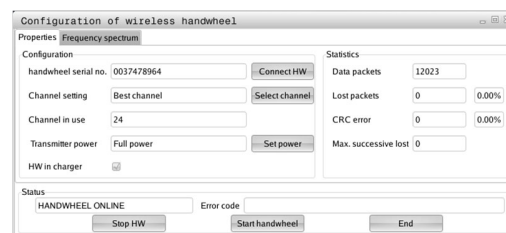

### Setting the transmission channel

If the wireless handwheel is started automatically, then the control tries to select the transmission channel providing the best transmission signal. Proceed as follows if you want to set the radio channel yourself:

- ▶ Press the **MOD** key to select the MOD function
- ▶ Select the **Machine settings** menu
- ▶ Select the configuration menu for the wireless handwheel: Press the **SET UP WIRELESS HANDWHEEL** soft key
- ▶ Click the **Frequency spectrum** tab
- ▶ Click on the **Stop HW** button
- ▶ The control stops the connection to the wireless handwheel and determines the current frequency spectrum for all 16 available channels.
- ▶ Memorize the number of the channel with the least amount of radio traffic (smallest bar)
- ▶ Click the **Start handwheel** button to reactivate the wireless handwheel
- ▶ Click the **Properties** tab
- ▶ Click on the **Select channel** button
- ▶ The controls shows all available channel numbers
- ▶ Click the number of the channel that the control has found to have the least amount of radio traffic
- ▶ To save the configuration and exit the configuration menu, press the **END** button

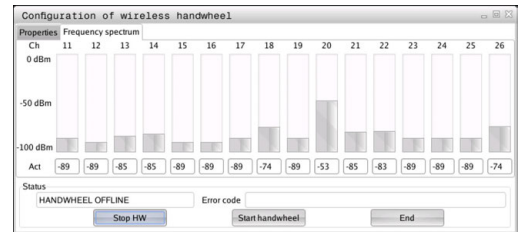
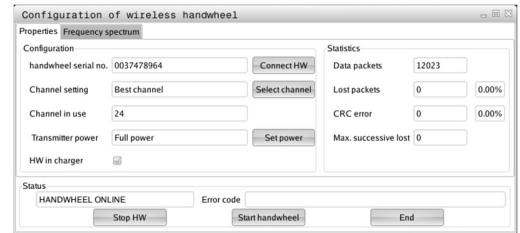

### Selecting the transmitter power



A reduction in transmission power decreases the range of the wireless handwheel.

- ▶ Press the **MOD** key to select the MOD function
- ▶ Select the **Machine settings** menu
- ▶ Select the configuration menu for the wireless handwheel: Press the **SET UP WIRELESS HANDWHEEL** soft key
- ▶ Click on the **Set power** button
- ▶ The control displays the three available power settings. Click on the desired setting.
- ▶ To save the configuration and exit the configuration menu, press the **END** button

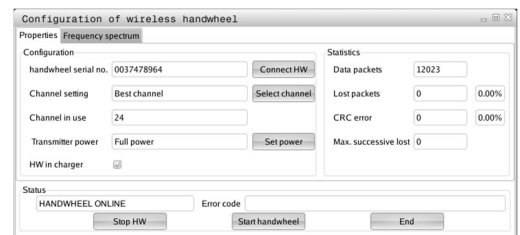

## Statistical data

To display the statistical data, proceed as follows:

- ▶ Press the **MOD** key to select the MOD function
- ▶ Select the **Machine settings** menu
- ▶ Select the configuration menu for the wireless handwheel:  
Press the **SET UP WIRELESS HANDWHEEL** soft key
- ▶ The control displays the configuration menu with the statistical data.

Under **Statistics**, the control displays information about the transmission quality.

If the reception quality is poor so that a proper and safe stop of the axes cannot be ensured anymore, an emergency-stop reaction of the wireless handwheel is triggered.

The displayed value **Max. successive lost** indicates whether reception quality is poor. If the control repeatedly displays values greater than 2 during normal operation of the wireless handwheel within the desired range of use, then there is a high risk of an undesired disconnection. This can be corrected by increasing the transmitter power or by changing to another channel with less radio traffic.

If this occurs, try to improve the transmission quality by selecting another channel or by increasing the transmitter power.

**Further information:** "Setting the transmission channel", page 771

**Further information:** "Selecting the transmitter power", page 771



## 19.16 Load machine configuration

### Application

#### NOTICE

**Caution: Data may be lost!**

The **RESTORE** function irrevocably overwrites the current machine configuration with the backup files. The control does not perform an automatic backup before the **RESTORE** function. The files are thus permanently gone.

- ▶ Perform a backup of the current machine configuration prior to the **RESTORE** function
- ▶ Use the function only in consultation with the machine tool builder

Your machine tool builder can provide you a backup with a machine configuration. After entering the keyword **RESTORE**, you can load the backup on your machine or programming station. Proceed as follows to load the backup:

- ▶ Enter the keyword **RESTORE** in the MOD dialog
- ▶ Select the backup file in the control's file manager (e.g., BKUP-2013-12-12\_.zip)
- > The control opens the pop-up window for the backup.
- ▶ Press Emergency Stop
- ▶ Press the **OK** soft key to start the backup process



# 20

**Tables and  
Overviews**

## 20.1 Machine-specific user parameters

### Application

The parameter values are entered in the **configuration editor**.



Refer to your machine manual.

The machine tool builder can additionally make some machine-specific machine parameters available as user parameters, so that the user can configure the functions that are available.

The machine parameters are grouped as parameter objects in a tree structure in the configuration editor. Each parameter object has a name (e.g. **Settings for screen displays**) that gives information about the parameters it contains. A parameter object, also called "entity," is marked with an **E** in the folder symbol in the tree structure. Some machine parameters have a key name to identify them unambiguously. The key name assigns the parameter to a group (e.g. X for X axis). The respective group folder bears the key name and is marked by a **K** in the folder symbol.



Operating notes:

- The icons of not yet active parameters and objects appear dimmed. These can be activated with the **MORE FUNCTIONS** and **INSERT** soft key.
- The control saves a modification list of the last 20 changes to the configuration data. To restore modifications, select the corresponding line and press the **MORE FUNCTIONS** and **CANCEL CHANGE** soft keys.

### Changing the display of the parameters

If you are in the configuration editor for the user parameters, you can change the display of the existing parameters. In the default setting, the parameters are displayed with short, explanatory texts.

Proceed as follows in order to have the actual system names of the parameters be shown:



- ▶ Press the **Screen layout** key

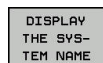

- ▶ Press the **SHOW SYSTEM NAME** soft key







Follow the same procedure to return to the standard display.





### Calling the configuration editor and changing parameters

- ▶ Select the **Programming** operating mode
- ▶ Press the **MOD** key
- ▶ Enter the code number **123**
- ▶ Changing parameters
- ▶ Press the **END** soft key to exit the configuration editor
- ▶ Confirm changes with the **SAVE** soft key

The icon at the beginning of each line in the parameter tree shows additional information about this line. The icons have the following meanings:

-  Branch exists but is closed
-  Branch is open
-  Empty object, cannot be opened
-  Initialized machine parameter
-  Uninitialized (optional) machine parameter
-  Can be read but not edited
-  Can neither be read nor edited

The type of the configuration object is identified by its folder symbol:

-  Key (group name)
-  List
-  Entity (parameter object)

### Displaying help texts

The **HELP** key enables you to call a help text for each parameter object or attribute.

If the help text does not fit on one page (1/2 is then displayed at the upper right, for example), press the **HELP PAGE** soft key to scroll to the second page.

As well as the Help text, other information is displayed, e.g. unit of measurement, initial value, selection list. If the selected machine parameter matches a parameter in the previous control model, the corresponding MP number is displayed.

**Parameter list****Parameter settings**

## DisplaySettings

Settings for screen display

Sequence of displayed axes

[0] to [7]

**Depends on available axes**

Sequence of the displayed axes in the REF display

[0] to [7]

**Depends on available axes**

Type of position display in position window

**NOMINAL**

**ACTUAL**

**REF ACTL**

**REF NOML**

**LAG**

**ACTDST**

**REFDST**

**M 118**

Type of position display in status display

**NOMINAL**

**ACTUAL**

**REF ACTL**

**REF NOML**

**LAG**

**ACTDST**

**REFDST**

**M 118**

Definition of decimal separator for position display

**. point**

**, comma**

Display of feed rate in operating mode Manual operation

**at axis key: Only display feed rate if axis direction key is pressed**

**always minimum: Always display feed rate**

Display of spindle position in the position display

**during closed loop: Only display spindle position if spindle is in position control**

**during closed loop and M5: Display spindle position if spindle is in position control and with M5**

Show or hide soft key preset table

**True: Soft key preset table is not displayed**

---

**Parameter settings**

---

**False: Display soft key preset table**

Font size with program display

**FONT\_APPLICATION\_SMALL****FONT\_APPLICATION\_MEDIUM**

Sequence of icons in the display

**[0] to [9]****Depends on activated options**

---

## DisplaySettings

Display step for individual axes

List of all available axes

Display step for position display in mm or degrees

**0.1****0.05****0.01****0.005****0.001****0.0005****0.0001****0.00005 (Option 23)****0.00001 (Option 23)**

Display step for position display in inches

**0.005****0.001****0.0005****0.0001****0.00005 (Option 23)****0.00001 (Option 23)**

---

## DisplaySettings

Definition of unit of measure valid for the display

**metric: Use metric system****inch: Use inch system**

---

## DisplaySettings

Format of NC programs and display of cycles

Program input in HEIDENHAIN Klartext conversational text or in DIN/ISO

**HEIDENHAIN: Program input in operating mode MDI in Klartext conversational text dialog****ISO: Program input in Positioning with MDI mode of operation in DIN/ISO**

---

---

**Parameter settings**

---

## DisplaySettings

Setting the NC and PLC dialog language

NC dialog language

**ENGLISH****GERMAN****CZECH****FRENCH****ITALIAN****SPANISH****PORTUGUESE****SWEDISH****DANISH****FINNISH****DUTCH****POLISH****HUNGARIAN****RUSSIAN****CHINESE****CHINESE\_TRAD****SLOVENIAN****KOREAN****NORWEGIAN****ROMANIAN****SLOVAK****TURKISH**

PLC dialog language

**See NC dialog language**

PLC error message language

**See NC dialog language**

Help language

**See NC dialog language**

---

---

**Parameter settings**

---

## DisplaySettings

Behavior with control start-up

Acknowledge "Power interrupted" message

**TRUE: Control start-up is not continued until the message has been acknowledged****FALSE: "Power interrupted" message not displayed**

---

DisplaySettings

Display mode for time display

Selection for display mode in the time display

**Analog****Digital****Logo****Analog and Logo****Digital and Logo****Analog on Logo****Digital on Logo**

---

DisplaySettings

Link row On/Off

Display setting for link row

**OFF: Deactivate the information line in the operating mode line****ON: Activate the information line in the operating mode line**

---

DisplaySettings

Settings for 3-D display

Model type of 3-D display

**3-D (compute-intensive): Model display for complex machining operations with undercuts****2.5-D: Model display for 3-axis machining operations****No Model: Model display is disabled**

Model quality of the 3-D display

**very high: High resolution; Block end points can be displayed****high: High resolution****medium: Medium resolution****low: Low resolution**

Reset tool paths in new BLK form

**ON: With new BLK form in the test run, the tool paths are reset****OFF: With new BLK form in the test run, the tool paths are not reset**

---

## Parameter settings

---

### DisplaySettings

Settings for the position display

#### Position display

with TOOL CALL DL

**As Tool Length: The programmed oversize DL is considered as the tool length modification for display of the workpiece-based position**

**As Workpiece Oversize: The programmed oversize DL is considered as the workpiece oversize for display of the workpiece-based position**

---

### DisplaySettings

Settings for the table editor

Behavior when deleting tools from the pocket table

**DISABLED: Deletion of the tool is not possible**

**WITH\_WARNING: Deletion of the tool is possible, must be confirmed**

**WITHOUT\_WARNING: Deletion of the tool is possible without needing to be confirmation**

Behavior when deleting index entries of a tool

**ALWAYS\_ALLOWED: Deletion of index entries is always possible**

**TOOL\_RULES: The behavior depends on the setting of the parameter "Behavior when deleting tools from the pocket table"**

Show the RÜCKS. SPALTE T soft key

**TRUE: The soft key is shown and all tools can be deleted from the tool memory by the user**

**FALSE: The soft key is not shown**

---

### DisplaySettings

Setting the coordinate systems for the display

Coordinate system for the datum shift

**WorkplaneSystem: Datum is displayed in the system of the tilted plane, WPL-CS**

**WorkpieceSystem: Datum is displayed in the workpiece coordinate system, W-CS**

---

---

**Parameter settings**

---

## ProbeSettings

Configuration of tool measurement

TT140\_1

M function for spindle orientation

**-1: Spindle orientation directly by NC****0: Function inactive****1 to 999: Number of M function for spindle orientation**

Probing routine

**MultiDirections: Probing from several directions****SingleDirection: Probing from one direction**

Probing direction for tool radius measurement

**X\_Positive, Y\_Positive, X\_Negative, Y\_Negative, Z\_Positive, Z\_Negative  
(depending on tool axis)**

Distance between lower surface of tool and upper surface of stylus

**0.001 to 99.9999 [mm]: Offset between stylus to tool**

Rapid traverse in probing cycle

**10 to 300 000 [mm/min]: Rapid traverse in probing cycle**

Probing feed rate with tool measurement

**1 to 3 000 [mm/min]: Probing feed rate with tool measurement**

Calculation of probing feed rate

**ConstantTolerance: Calculation of probing feed rate with constant tolerance****VariableTolerance: Calculation of probing feed rate with variable tolerance****ConstantFeed: Constant probing feed rate**

Type of speed detection

**Automatic: Determine speed automatically****MinSpindleSpeed: Use minimum spindle speed**

Maximum permissible rotational speed the tool tip

**1 to 129 [m/min]: Permissible rotational speed on cutter circumference**

Maximum permissible speed with tool measurement

**0 to 1 000 [rpm]: Maximum permissible speed**

Maximum permissible measuring error with tool measurement

**0.001 to 0.999 [mm]: First maximum permissible measuring error**

Maximum permissible measuring error with tool measurement

**0.001 to 0.999 [mm]: Second maximum permissible measuring error**

NC stop during tool check

**True: NC program is stopped if breakage tolerance is exceeded**

---

**Parameter settings**

---

**False: NC program is not stopped**

NC stop during tool measurement

**True: NC program is stopped if breakage tolerance is exceeded**

**False: NC program is not stopped**

Modifying of tool table during tool check and measurement

**AdaptOnMeasure: Table is modified after tool measurement**

**AdaptOnBoth: Table is modified after tool check and measurement**

**AdaptNever: Table is not modified after tool check and measurement**

Configuration of a round stylus

TT140\_1

Coordinates of the stylus center

**[0]: X coordinate of stylus center referenced to machine datum**

**[1]: Y coordinate of stylus center referenced to machine datum**

**[2]: Z coordinate of stylus center referenced to machine datum**

Safety clearance over stylus for pre-positioning

**0.001 to 99 999.9999 [mm]: Safety clearance in tool axis direction**

Safety zone around stylus for pre-positioning

**0.001 to 99 999.9999 [mm]: Safety clearance in plane perpendicular to tool axis**

---



---

**Parameter settings**

---

## ChannelSettings

## CH\_NC

## Active kinematics

Kinematics to be activated

**List of machine kinematics**

Kinematics to be activated with control start-up

**List of machine kinematics**

## Determining the behavior of the NC program

Resetting the machining time with program start

**True: Machining time is reset****False: Machining time is not reset**

PLC signal for number of pending machining cycle

**Dependent on machine manufacturer**

## Geometry tolerances

Permissible deviation of circle radius

**0.0001 to 0.016 [mm]: Permissible deviation of circle radius on the circle end point compared to circle start point**

Permissible error in successive threads

## Configuration of machining cycles

Overlap factor for pocket milling

**0.001 to 1.414: Overlap factor for Cycle 4 POCKET MILLING and Cycle 5 CIRCULAR POCKET**

Behavior after machining a contour pocket

**PosBeforeMachining: Position as before machining a cycle****ToolAxClearanceHeight: Position tool axis to clearance height**Display **Spindle ?** error message if M3/M4 is not active**on: Output error message****off: Do not output error message**Display **Enter negative depth** error message**on: Output error message****off: Do not output error message**

Approach behavior on a slot wall in a cylindrical surface

**LineNormal: Approach with straight line****CircleTangential: Approach with an arc movement**

M function for spindle orientation in machining cycles

**-1: Spindle orientation directly via NC**

---

**Parameter settings**

---

**0: Function inactive**

**1 to 999: Number of M function for spindle orientation**

Do not display "**Plunging type not possible**" error message

**on: Error message is not displayed**

**off: Error message is displayed**

Behavior of M7 and M8 with cycles 202 and 204

**TRUE: At the end of cycle 202 and 204 the condition of M7 and M8 is restored before the cycle call**

**FALSE: At the end of cycle 202 and 204 the condition of M7 and M8 is not restored independently**

Do not show **Remaining material** warning

**on: Warning is not displayed**

**off: Warning is displayed**

Geometry filter for filtering out linear elements

Type of stretch filter

- **Off: No filter active**

- **ShortCut: Leave out single points on polygon**

- **Average: The geometry filter smooths corners**

Maximum distance of filtered to unfiltered contour

**0 to 10 [mm]: The filtered out points lie within this tolerance to the resultant distance**

Maximum length of distance resulting from filtering

**0 to 1000 [mm]: Length over which geometry filtering is effective**

CfgThreadSpindle

Potentiometer for feed rate during thread cutting

**SpindlePotentiometer: During thread cutting, the potentiometer for shaft speed override is effective. The potentiometer for feed rate override is not active**

**FeedPotentiometer: During thread cutting, the potentiometer for feed rate override is effective. The potentiometer for shaft speed override is not active**

Waiting time at reversal point in thread base

**-999999999 to 999999999: The spindle stops for this time at the bottom of the thread before starting again in the opposite direction of rotation**

Advanced switching time of spindle

**-999999999 to 999999999: The spindle is stopped at this time before reaching the bottom of the thread**

---

**Parameter settings**

---

Limitation of spindle speed for Cycles 17, 207, and 18

**TRUE: For small thread depths the spindles speed is limited to the extent that for about 1/3 of the time it runs at a constant speed**

**FALSE: No limitation of the spindle speed**

---

---

## Parameter settings

---

Settings for the NC editor

Creating backup files

**TRUE: Create backup file after editing NC programs**

**FALSE: Create no backup file after editing NC programs**

Cursor behavior after deleting lines

**TRUE: Cursor is on previous line after deletion (iTNC behavior)**

**FALSE: Cursor is on subsequent line after deletion**

Cursor behavior with the first and last line

**TRUE: All-round cursors permitted at PGM beginning/end**

**FALSE: All-round cursors not permitted at PGM beginning/end**

Line break with multi-line blocks

**ALL: Always show lines completely**

**ACT: Only show lines of the active block completely**

**NO: Only show lines completely if the block is edited**

Activate help graphics with cycle input

**TRUE: Fundamentally always show help graphics during input**

**FALSE: Only show help graphics if the CYCLE HELP soft key is set to ON. The CYCLE HELP OFF/ON soft key is displayed in the Programming mode after pressing the "Screen layout" button**

Behavior of soft key row following a cycle input

**TRUE: Leave cycle soft key row active after a cycle definition**

**FALSE: Hide cycle soft key row after a cycle definition**

Confirmation request before block is deleted

**TRUE: Display confirmation request before deleting an NC block**

**FALSE: Do not display confirmation request before deleting an NC block**

Line number up to which NC program is tested

**100 to 50000: Program length for which the geometry is to be checked**

ISO programming: Block number increment

**0 to 250: Increment for generating ISO blocks in the program**

Define programmable axes

**TRUE: Use defined axis configuration**

**FALSE: Use default axis configuration XYZABCUVW**

Behavior with paraxial positioning blocks

**TRUE: Paraxial positioning blocks permitted**

**FALSE: Paraxial positioning blocks locked**

Line number up to which identical syntax elements are searched for

**500 to 50000: Search for selected elements with up/down arrow keys**

---

**Parameter settings**

---

Behavior of PARAXMODE function with UVW axes

**FALSE: PARAXMODE function permitted**

**TRUE: PARAXMODE function locked**

---

Settings for the file manager

Display of dependent files

**MANUAL: Dependent files are displayed**

**AUTOMATIC: Dependent files are not displayed**

---

Path specifications for end users

List with drives and/or directories

**Drives and directories entered here are shown by the control in the file manager**

FN 16 output path for execution

**Path for FN 16 output if no path has been defined in the program**

FN 16 output path for Programming and Test Run operating modes

**Path for FN 16 output if no path has been defined in the program**

---

Serial Interface RS232

**Further information:** "Setting up data interfaces", page 751

## 20.2 Connector pin layout and connection cables for data interfaces

### RS-232-C/V.24 interface for HEIDENHAIN devices



The interface complies with the requirements of EN 50 178 for **Low voltage electrical separation**.

When using the 25-pin adapter block:

Control		Conn. cable 365725-xx		Adapter block 310085-01		Conn. cable 274545-xx			
Male	Assignment	Female	Color	Female	Male	Female	Male	Color	Female
1	Do not assign	1		1	1	1	1	White/ Brown	1
2	RXD	2	Yellow	3	3	3	3	Yellow	2
3	TXD	3	Green	2	2	2	2	Green	3
4	DTR	4	Brown	20	20	20	20	Brown	8
5	Signal GND	5	Red	7	7	7	7	Red	7
6	DSR	6	Blue	6	6	6	6		6
7	RTS	7	Gray	4	4	4	4	Gray	5
8	CTR	8	Pink	5	5	5	5	Pink	4
9	Do not assign	9					8	Violet	20
Hsg.	External shield	Hsg.	External shield	Hsg.	Hsg.	Hsg.	Hsg.	External shield	Hsg.

When using the 9-pin adapter block:

<b>Control</b>		<b>Conn. cable 355484-xx</b>		<b>Adapter block 363987-02</b>			<b>Conn. cable 366964-xx</b>		
<b>Male</b>	<b>Assign-ment</b>	<b>Female</b>	<b>Color</b>	<b>Male</b>	<b>Female</b>	<b>Male</b>	<b>Female</b>	<b>Color</b>	<b>Female</b>
1	Do not assign	1	Red	1	1	1	1	Red	1
2	RXD	2	Yellow	2	2	2	2	Yellow	3
3	TXD	3	White	3	3	3	3	White	2
4	DTR	4	Brown	4	4	4	4	Brown	6
5	Signal GND	5	Black	5	5	5	5	Black	5
6	DSR	6	Violet	6	6	6	6	Violet	4
7	RTS	7	Gray	7	7	7	7	Gray	8
8	CTR	8	White/ Green	8	8	8	8	White/ Green	7
9	Do not assign	9	Green	9	9	9	9	Green	9
Hsg.	External shield	Hsg.	External shield	Hsg.	Hsg.	Hsg.	Hsg.	External shield	Hsg.

## Non-HEIDENHAIN devices

The connector layout of a non-HEIDENHAIN device may substantially differ from that of a HEIDENHAIN device.

It depends on the unit and the type of data transfer. The table below shows the connector pin layout on the adapter block.

Adapter block 363987-02		Conn. cable 366964-xx		
Female	Male	Female	Color	Female
1	1	1	Red	1
2	2	2	Yellow	3
3	3	3	White	2
4	4	4	Brown	6
5	5	5	Black	5
6	6	6	Violet	4
7	7	7	Gray	8
8	8	8	White/Green	7
9	9	9	Green	9
Hsg.	Hsg.	Hsg.	External shield	Hsg.

## Ethernet interface RJ45 socket

Maximum cable length:

- Unshielded: 100 m
- Shielded: 400 m

Pin	Signal	Description
1	TX+	Transmit Data
2	TX-	Transmit Data
3	REC+	Receive Data
4	Vacant	
5	Vacant	
6	REC-	Receive Data
7	Vacant	
8	Vacant	



## 20.3 Technical Information

### Explanation of symbols

- Default
- Axis option
- 1 Advanced Function Set 1
- 2 Advanced Function Set 2
- x Software option, except Advanced Function Set 1 and Advanced Function Set 2

### Specifications

<b>Components</b>	<ul style="list-style-type: none"> <li>■ Operating panel</li> <li>■ TFT color flat-panel display with soft keys or TFT color flat-panel display with touchscreen</li> </ul>
<b>Program memory</b>	<ul style="list-style-type: none"> <li>■ 2 GB</li> </ul>
<b>Input resolution and display step</b>	<ul style="list-style-type: none"> <li>■ As fine as 0.1 µm for linear axes</li> <li>■ As fine as 0.01 µm for linear axes (with option 23)</li> <li>■ Up to 0.0001° for rotary axes</li> <li>■ Up to 0.000 01° for rotary axes (with option 23)</li> </ul>
<b>Input range</b>	<ul style="list-style-type: none"> <li>■ Maximum 999 999 999 mm or 999 999 999°</li> </ul>
<b>Interpolation</b>	<ul style="list-style-type: none"> <li>■ Linear in 4 axes</li> <li>■ Circular in 2 axes</li> <li>■ Helical: superimposition of circular and straight paths</li> </ul>
<b>Block processing time</b> 3-D straight line without radius compensation	<ul style="list-style-type: none"> <li>■ 1.5 ms</li> </ul>
<b>Axis feedback control</b>	<ul style="list-style-type: none"> <li>■ Position loop resolution: Signal period of the position encoder/1024</li> <li>■ Cycle time of position controller: 3 ms</li> <li>■ Cycle time of speed controller: 200 µs</li> </ul>
<b>Range of traverse</b>	<ul style="list-style-type: none"> <li>■ Maximum 100 m (3937 inches)</li> </ul>
<b>Spindle speed</b>	<ul style="list-style-type: none"> <li>■ Maximum 100,000 rpm (analog speed command signal)</li> </ul>
<b>Error compensation</b>	<ul style="list-style-type: none"> <li>■ Linear and nonlinear axis error, backlash, reversal peaks during circular movements, thermal expansion</li> <li>■ Static friction</li> </ul>
<b>Data interfaces</b>	<ul style="list-style-type: none"> <li>■ One each RS-232-C /V.24 max. 115 kilobaud</li> <li>■ Expanded data interface with LSV-2 protocol for remote operation of the control through the data interface with the HEIDENHAIN software TNCremo</li> <li>■ Ethernet interface 1000 BaseT</li> <li>■ 5 x USB (1 x front USB 2.0; 4 x rear USB 3.0)</li> </ul>
<b>Ambient temperature</b>	<ul style="list-style-type: none"> <li>■ Operation: 5 °C to +45 °C</li> <li>■ Storage: -35 °C to +65 °C</li> </ul>

---

**Input formats and units of control functions**

---

<b>Positions, coordinates, circle radii, chamfer lengths</b>	-99 999.9999 to +99 999.9999 (5,4: number of digits before and after the decimal point) [mm]
<b>Tool numbers</b>	0 to 32 767.9 (5, 1)
<b>Tool names</b>	32 characters, enclosed by quotation marks with <b>TOOL CALL</b> . Permitted special characters: # \$ % & . , - _
<b>Detail values for tool compensation</b>	-99.9999 to +99.9999 (2, 4) [mm]
<b>Spindle speeds</b>	0 to 99 999.999 (5, 3) [rpm]
<b>Feed rates</b>	0 to 99,999.999 (5, 3) [mm/min] or [mm/tooth] or [mm/1]
<b>Dwell time in Cycle 9</b>	0 to 3600.000 (4, 3) [s]
<b>Thread pitch in various cycles</b>	-9.9999 to +9.9999 (2, 4) [mm]
<b>Angle for spindle orientation</b>	0 to 360.0000 (3, 4) [°]
<b>Angle for polar coordinates, rotation, tilting the working plane</b>	-360.0000 to 360.0000 (3, 4) [°]
<b>Polar coordination for screw line interpolation (CP)</b>	-5 400.0000 to 5 400.0000 (4, 4) [°]
<b>Datum numbers in Cycle 7</b>	0 to 2999 (4, 0)
<b>Scaling factor in Cycles 11 and 26</b>	0.000001 to 99.999999 (2, 6)
<b>Miscellaneous functions M</b>	0 to 999 (4, 0)
<b>Q parameter numbers</b>	0 to 1999 (4, 0)
<b>Q parameter values</b>	-99 999.9999 to +99 999.9999 (9, 6)
<b>Labels (LBL) for program jumps</b>	0 to 999 (5, 0)
<b>Labels (LBL) for program jumps</b>	Any text string in quotation marks (""")
<b>Number of program section repeats REP</b>	1 to 65 534 (5, 0)
<b>Error number in Q parameter function FN14</b>	0 to 1199 (4, 0)

## User functions

### User functions

<b>Short description</b>	<ul style="list-style-type: none"> <li>■ Basic version: 3 axes plus closed-loop spindle</li> <li>□ Additional axis for 4 axes plus closed-loop spindle</li> <li>□ Additional axis for 5 axes plus closed-loop spindle</li> </ul>
<b>Program entry</b>	In HEIDENHAIN conversational format and DIN/ISO
<b>Position entry</b>	<ul style="list-style-type: none"> <li>■ Nominal positions for lines and arcs in Cartesian coordinates or polar coordinates</li> <li>■ Incremental or absolute dimensions</li> <li>■ Display and entry in mm or inches</li> </ul>
<b>Tool compensation</b>	<ul style="list-style-type: none"> <li>■ Tool radius in the working plane and tool length</li> <li>x Radius compensated contour look ahead for up to 99 blocks (M120)</li> </ul>
<b>Tool tables</b>	Multiple tool tables with any number of tools
<b>Constant contour speed</b>	<ul style="list-style-type: none"> <li>■ With respect to the path of the tool center</li> <li>■ With respect to the cutting edge</li> </ul>
<b>Parallel operation</b>	Creating a program with graphical support while another program is being run
<b>Cutting data</b>	Automatic calculation of spindle speed, cutting speed, feed per tooth and feed per revolution
<b>3-D machining (Advanced Function Set 2)</b>	<ul style="list-style-type: none"> <li>2 Motion control with minimum jerk</li> <li>2 3-D tool compensation through surface normal vectors</li> <li>2 Using the electronic handwheel to change the angle of the swivel head during program run without affecting the position of the tool center point (tool tip or center of sphere) (TCPM = <b>T</b>ool <b>C</b>enter <b>P</b>oint <b>M</b>anagement)</li> <li>2 Keeping the tool normal to the contour</li> <li>2 Tool radius compensation perpendicular to traversing and tool direction</li> </ul>
<b>Rotary table machining (Advanced Function Set 1)</b>	<ul style="list-style-type: none"> <li>1 Programming of cylindrical contours as if in two axes</li> <li>1 Feed rate in distance per minute</li> </ul>
<b>Contour elements</b>	<ul style="list-style-type: none"> <li>■ Straight line</li> <li>■ Chamfer</li> <li>■ Circular path</li> <li>■ Circle center</li> <li>■ Circle radius</li> <li>■ Tangentially connected arc</li> <li>■ Corner rounding</li> </ul>
<b>Approaching and departing the contour</b>	<ul style="list-style-type: none"> <li>■ Via straight line: tangential or perpendicular</li> <li>■ Via circular arc</li> </ul>
<b>Free contour programming (FK)</b>	x FK free contour programming in HEIDENHAIN conversational format with graphic support for workpiece drawings not dimensioned for NC

---

**User functions**

---

**Program jumps**

- Subprograms
- Program section repeats
- Any desired program as subprogram

**Machining cycles**

- Cycles for drilling, and conventional and rigid tapping
- Roughing of rectangular and circular pockets
- x Cycles for pecking, reaming, boring, and counterboring
- x Cycles for milling internal and external threads
- x Finishing of rectangular and circular pockets
- x Cycles for clearing level and inclined surfaces
  
- x Cycles for milling linear and circular slots
- x Cartesian and polar point patterns
- x Contour-parallel contour pocket
- x Contour train
- x OEM cycles (special cycles developed by the machine manufacturer) can also be integrated

**Coordinate transformation**

- Datum shift, rotation, mirroring
- Scaling factor (axis-specific)
- 1 Tilting the working plane (Advanced Function Set 1)

**Q parameters**

Programming with variables

- Mathematical functions =, +, -, \*, /, roots
- Logical operations (=, ≠, <, >)
- Calculating with parentheses
- $\sin \alpha$ ,  $\cos \alpha$ ,  $\tan \alpha$ ,  $\arcsin$ ,  $\arccos$ ,  $\arctan$ ,  $a^n$ ,  $e^n$ ,  $\ln$ ,  $\log$ , absolute value of a number, constant  $\pi$ , negation, truncation of digits before or after the decimal point
- Functions for calculation of circles
- String param.

**Programming aids**

- Calculator
- Complete list of all current error messages
- Context-sensitive help function for error messages
- TNCguide: The integrated help system.
- Graphic support for the programming of cycles
- Comment and structure blocks in the NC program

**Teach-In**

- Actual positions can be transferred directly to the NC program

**Test graphics**

Display modes

- x Graphical simulation before a program run, also while another program is being run
  - x Plan view / projection in 3 planes / 3-D view / 3-D line graphics
  - x Detail enlargement
-

---

**User functions**

---

<b>Programming graphics</b>	■	In <b>Programming</b> mode, the contour of the NC blocks is drawn on screen while they are being entered (2-D pencil-trace graphics), even if another program is running
<b>Program-run graphics</b> Display modes	x	Graphic simulation of real-time machining in plan view / projection in 3 planes / 3-D view
<b>Machining time</b>	■	Calculation of machining time in the <b>Test Run</b> operating mode
	■	Display of the current machining time in the <b>Program Run, Single Block</b> and <b>Program Run, Full Sequence</b> operating modes
<b>Datum management</b>	■	For saving any datums
<b>Contour, returning to</b>	■	Block scan in any block in the program, returning the tool to the calculated nominal position to continue machining
	■	Program interruption, contour departure and return
<b>Datum tables</b>	■	Multiple datum tables for storing workpiece-specific datums
<b>Touch probe cycles</b>	x	Calibrating the touch probe
	x	Compensation of workpiece misalignment, manual or automatic
	x	Presetting, manual or automatic
	x	Automatic workpiece measurement
	x	Tools can be measured automatically

## Software options

---

### Advanced Function Set 1 (option 8)

---

#### Expanded functions Group 1

#### Machining with rotary tables

- Cylindrical contours as if in two axes
- Feed rate in distance per minute

#### Coordinate conversions:

Tilting the working plane

---

### Advanced Function Set 2 (option 9)

---

#### Expanded functions Group 2

Export license required

#### 3-D machining:

- Motion control with minimum jerk
- 3-D tool compensation through surface-normal vectors
- Using the electronic handwheel to change the angle of the swivel head during program run without affecting the position of the tool center point (tool tip or center of sphere) (TCPM = **T**ool **C**enter **P**oint **M**anagement)
- Keeping the tool normal to the contour
- Tool radius compensation perpendicular to traversing direction and tool direction

#### Interpolation:

Linear in 5 axes

---

### Touch Probe Functions (option 17)

---

#### Touch probe functions

#### Touch probe cycles:

- Compensation of tool misalignment in automatic mode
  - Presetting in the **Manual operation** mode of operation
  - Presetting in automatic mode
  - Automatically measuring workpieces
  - Tools can be measured automatically
- 

### HEIDENHAIN DNC (option 18)

---

Communication with external PC applications over COM component

---

### Advanced Programming Features (option 19)

---

#### Expanded programming functions

#### FK free contour programming:

Programming in HEIDENHAIN conversational format with graphic support for workpiece drawings not dimensioned for NC

**Advanced Programming Features (option 19)****Fixed cycles:**

- Peck drilling, reaming, boring, counterboring, centering (cycles 201 to 205, 208, 240, 241)
- Milling of internal and external threads (cycles 262 to 265, 267)
- Finishing of rectangular and circular pockets and studs (cycles 212 to 215, 251 to 257)
- Clearing level and oblique surfaces (cycles 230 to 233)
- Straight slots and circular slots (cycles 210, 211, 253, 254)
- Linear and circular point patterns (cycles 220, 221)
- Contour train, contour pocket—also with contour-parallel machining, trochoidal slot (cycles 20 to 25, 275)
- Engraving (cycle 225)
- OEM cycles (special cycles developed by the machine tool builder) can be integrated

**Advanced Graphic Features (option 20)****Expanded graphic functions****Program-verification graphics, program-run graphics**

- Plan view
- Projection in three planes
- 3-D view

**Advanced Function Set 3 (option 21)****Expanded functions Group 3****Tool compensation:**

M120: Radius-compensated contour look-ahead for up to 99 blocks

**3-D machining:**

M118: Superimpose handwheel positioning during program run

**Pallet Management (option 22)****Pallet management**

Processing workpieces in any sequence

**Display Step (option 23)****Display step****Input resolution:**

- Linear axes down to 0.01  $\mu\text{m}$
- Rotary axes to 0.00001°

**CAD Import (option 42)****CAD import**

- Support for DXF, STEP and IGES
- Adoption of contours and point patterns
- Simple and convenient specification of presets
- Selecting graphical features of contour sections from conversational programs

**KinematicsOpt (option 48)****Optimizing the machine kinematics**

- Backup/restore active kinematics
- Test active kinematics
- Optimize active kinematics

**Extended Tool Management (option 93)**

<b>Extended tool management</b>	Python-based
---------------------------------	--------------

**Remote Desktop Manager (option 133)**

<b>Remote operation of external computer units</b>	<ul style="list-style-type: none"> <li>■ Windows on a separate computer unit</li> <li>■ Incorporated in the control's interface</li> </ul>
----------------------------------------------------	--------------------------------------------------------------------------------------------------------------------------------------------

**Cross Talk Compensation – CTC (option 141)**

<b>Compensation of axis couplings</b>	<ul style="list-style-type: none"> <li>■ Determination of dynamically caused position deviation through axis acceleration</li> <li>■ Compensation of the TCP (<b>T</b>ool <b>C</b>enter <b>P</b>oint)</li> </ul>
---------------------------------------	------------------------------------------------------------------------------------------------------------------------------------------------------------------------------------------------------------------

**Position Adaptive Control – PAC (option 142)**

<b>Adaptive position control</b>	<ul style="list-style-type: none"> <li>■ Changing of the control parameters depending on the position of the axes in the working space</li> <li>■ Changing of the control parameters depending on the speed or acceleration of an axis</li> </ul>
----------------------------------	---------------------------------------------------------------------------------------------------------------------------------------------------------------------------------------------------------------------------------------------------

**Load Adaptive Control – LAC (option 143)**

<b>Adaptive load control</b>	<ul style="list-style-type: none"> <li>■ Automatic determination of workpiece weight and frictional forces</li> <li>■ Changing of control parameters depending on the actual mass of the workpiece</li> </ul>
------------------------------	---------------------------------------------------------------------------------------------------------------------------------------------------------------------------------------------------------------

**Active Chatter Control – ACC (option 145)**

<b>Active chatter control</b>	Fully automatic function for chatter control during machining
-------------------------------	---------------------------------------------------------------

**Active Vibration Damping – AVD (option 46)**

<b>Active vibration damping</b>	Damping of machine oscillations to improve the workpiece surface
---------------------------------	------------------------------------------------------------------

**Batch Process Manager (option 154)**

<b>Batch process manager</b>	Planning of production orders
------------------------------	-------------------------------



## Accessories

---

### Accessories

---

#### Electronic handwheels

- HR 410: Portable handwheel
  - HR 550FS: Portable wireless handwheel with display
  - HR 520: Portable handwheel with display
  - HR 420: Portable handwheel with display
  - HR 130: Panel-mounted handwheel
  - HR 150: Up to three panel-mounted handwheels via handwheel adapter HRA 110
- 

#### Touch probes

- TS 248: 3-D touch trigger probe with cable connection
- TS 260: 3-D touch trigger probe with cable connection
- TS 444: Battery-free 3-D touch trigger probe with infrared transmission
- TS 460: 3-D touch trigger probe with infrared and radio transmission
- TS 642: 3-D touch trigger probe with infrared transmission
- TS 740: High-precision 3-D touch trigger probe with infrared transmission
- TT 160: 3-D touch trigger probe for tool measurement
- TT 460: 3-D touch trigger probe for tool measurement with infrared transmission

## 20.4 Overview tables

### Fixed cycles

Cycle number	Cycle name	DEF active	CALL active
7	DATUM SHIFT	■	
8	MIRROR IMAGE	■	
9	DWELL TIME	■	
10	ROTATION	■	
11	SCALING	■	
12	PGM CALL		■
13	ORIENTATION	■	
14	CONTOUR GEOMETRY	■	
18	THREAD CUTTING		■
19	WORKING PLANE	■	
20	CONTOUR DATA	■	
21	PILOT DRILLING		■
22	ROUGH-OUT		■
23	FLOOR FINISHING		■
24	SIDE FINISHING		■
25	CONTOUR TRAIN		■
26	AXIS-SPECIFIC SCALING	■	
27	CYLINDER SURFACE		■
28	CYLINDER SURFACE		■
29	CYL SURFACE RIDGE		■
32	TOLERANCE	■	
39	CYL. SURFACE CONTOUR		■
200	DRILLING		■
201	REAMING		■
202	BORING		■
203	UNIVERSAL DRILLING		■
204	BACK BORING		■
205	UNIVERSAL PECKING		■
206	TAPPING		■
207	RIGID TAPPING		■
208	BORE MILLING		■
209	TAPPING W/ CHIP BRKG		■
220	POLAR PATTERN	■	
221	CARTESIAN PATTERN	■	

<b>Cycle number</b>	<b>Cycle name</b>	<b>DEF active</b>	<b>CALL active</b>
225	ENGRAVING		■
232	FACE MILLING		■
233	FACE MILLING		■
239	ASCERTAIN THE LOAD	■	
240	CENTERING		■
241	SINGLE-LIP D.H.DRLNG		■
247	PRESETTING	■	
251	RECTANGULAR POCKET		■
252	CIRCULAR POCKET		■
253	SLOT MILLING		■
254	CIRCULAR SLOT		■
256	RECTANGULAR STUD		■
257	CIRCULAR STUD		■
258	POLYGON STUD		■
262	THREAD MILLING		■
263	THREAD MLLNG/CNTSNKG		■
264	THREAD DRILLNG/MLLNG		■
265	HEL. THREAD DRLG/MLG		■
267	OUTSIDE THREAD MLLNG		■
270	CONTOUR TRAIN DATA	■	
275	TROCHOIDAL SLOT		■
276	THREE-D CONT. TRAIN		■

## Miscellaneous functions

M	Effect	Effective at block	Start	End	Page
<b>M0</b>	Program STOP/Spindle STOP/Coolant OFF			■	470
<b>M1</b>	Optional program run STOP/Spindle STOP/Coolant OFF			■	736
<b>M2</b>	Stop program/Spindle STOP/Coolant OFF/ CLEAR status display (depending on machine parameter)/Return jump to block 1			■	470
<b>M3</b>	Spindle ON clockwise		■		470
M4	Spindle ON counterclockwise		■		
M5	Spindle STOP			■	
<b>M6</b>	Tool change/STOP program run (depending on machine parameter)/Spindle STOP			■	470
<b>M8</b>	Coolant ON		■		470
M9	Coolant OFF			■	
<b>M13</b>	Spindle ON clockwise/Coolant ON		■		470
M14	Spindle ON counterclockwise/Coolant on		■		
<b>M30</b>	Same function as M2			■	470
<b>M89</b>	Vacant miscellaneous function <b>or</b> cycle call, modally effective (depending on machine parameter)		■	■	Cycles Manual
<b>M91</b>	Within the positioning block: Coordinates are referenced to machine datum		■		471
<b>M92</b>	Within the positioning block: Coordinates are referenced to a position defined by machine manufacturer, e.g. tool change position		■		471
<b>M94</b>	Reduce the rotary axis display to a value below 360°		■		567
<b>M97</b>	Machine small contour steps			■	474
<b>M98</b>	Machine open contours completely			■	475
<b>M99</b>	Blockwise cycle call			■	Cycles Manual
<b>M101</b>	Automatic tool change with replacement tool if maximum tool life has expired			■	251
M102	Reset M101			■	
<b>M107</b>	Suppress error message for replacement tools with oversize			■	580
M108	Reset M107			■	
<b>M109</b>	Constant contouring speed at cutting edge (feed rate increase and reduction)		■		478
<b>M110</b>	Constant contouring speed at cutting edge (only feed rate reduction)		■		
M111	Reset M109/M110			■	
<b>M116</b>	Feed rate in mm/min on rotary axes		■		565
M117	Reset M116			■	
<b>M118</b>	Superimpose handwheel positioning during program run		■		481
<b>M120</b>	Pre-calculate the radius-compensated contour (LOOK AHEAD)		■		479
<b>M126</b>	Shorter-path traverse of rotary axes		■		566
M127	Reset M126			■	
<b>M128</b>	Maintaining the position of the tool tip when positioning with tilted axes (TCPM)		■		568
M129	Reset M128			■	

<b>M</b>	<b>Effect</b>	<b>Effective at block</b>	<b>Start</b>	<b>End</b>	<b>Page</b>
<b>M130</b>	Within the positioning block: Points are referenced to the untilted coordinate system		■		473
<b>M136</b>	Feed rate F in millimeters per spindle revolution		■		477
M137	Reset M136				
<b>M138</b>	Selection of tilted axes		■		571
<b>M140</b>	Retraction from the contour in the tool-axis direction		■		483
<b>M143</b>	Delete basic rotation		■		486
<b>M144</b>	Compensating the machine's kinematic configuration for ACTUAL/ NOMINAL positions at end of block		■		572
M145	Reset M144			■	
<b>M141</b>	Suppress touch probe monitoring		■		485
<b>M148</b>	Automatically retract tool from the contour at an NC stop		■		487
M149	Reset M148			■	

## 20.5 Functions of the TNC 620 and the iTNC 530 compared

### Comparison: Specifications

Function	TNC 620	iTNC 530
Control loops	Maximum 8 control loops (including up to 2 spindles)	18 maximum
<b>Input resolution and display step:</b>		
<ul style="list-style-type: none"> <li>■ Linear axes</li> <li>■ Rotary axes</li> </ul>	<ul style="list-style-type: none"> <li>■ 0.1 μm, 0.01 μm with option 23</li> <li>■ 0.001°, 0.00001° with option 23</li> </ul>	<ul style="list-style-type: none"> <li>■ 0.1 μm</li> <li>■ 0.0001°</li> </ul>
Display	15.1-inch TFT color flat-panel display or 19-inch touchscreen	19-inch TFT color flat-panel display or 15.1-inch TFT color flat-panel display
Memory media for NC, PLC programs, and system files	CompactFlash memory card	Hard disk or SSDR solid state disk
Program memory for NC programs	2 GB	> 21 GB
Block processing time	1.5 ms	0.5 ms
<b>Interpolation:</b>		
<ul style="list-style-type: none"> <li>■ Straight line</li> <li>■ Circle</li> <li>■ Helix</li> <li>■ Spline</li> </ul>	<ul style="list-style-type: none"> <li>■ 5 axes</li> <li>■ 3 axes</li> <li>■ yes</li> <li>■ No</li> </ul>	<ul style="list-style-type: none"> <li>■ 5 axes</li> <li>■ 3 axes</li> <li>■ Yes</li> <li>■ Yes with option 9</li> </ul>
Hardware	Compact in operating panel or Modular in electrical cabinet	Modular in electrical cabinet

### Comparison: Data interfaces

Function	TNC 620	iTNC 530
Gigabit-Ethernet 1000Base-T	X	X
RS-232-C/V.24 serial interface	X	X
RS-422/V.11 serial interface	-	X
USB interface	X	X

**Further information:** "Setting up data interfaces", page 751

**Comparison: PC software**

Function	TNC 620	iTNC 530
<b>ConfigDesign</b> for the configuration of machine parameters	Available	Not available
<b>TNCAnalyzer</b> for the analysis and evaluation of service files	Available	Not available

**Comparison: User functions**

Function	TNC 620	iTNC 530
<b>Program entry</b>		
■ Klartext	■ X	■ X
■ DIN/ISO	■ X	■ X
■ smarT.NC	■ –	■ X
■ ASCII editor	■ X, directly editable	■ X, editable after conversion
<b>Position entry</b>		
■ Nominal positions for lines and arcs in Cartesian coordinates	■ X	■ X
■ Nominal positions for lines and arcs in polar coordinates	■ X	■ X
■ Incremental or absolute dimensions	■ X	■ X
■ Display and entry in mm or inches	■ X	■ X
■ Set the last tool position as pole (empty CC block)	■ X (error message if pole transfer is ambiguous)	■ X
■ Surface-normal vectors ( <b>LN</b> )	■ X	■ X
■ Spline sets ( <b>SPL</b> )	■ –	■ X, with option 9

Function	TNC 620	iTNC 530
<b>Tool compensation</b>		
■ In the working plane and tool length	■ X	■ X
■ Radius compensated contour look ahead for up to 99 blocks	■ X, with option 21	■ X
■ Three-Dimensional Tool Radius Compensation	■ X, with option 9	■ X, with option 9
<b>Tool table</b>		
■ Central storage of tool data	■ X	■ X
■ Multiple tool tables with any number of tools	■ X	■ X
■ Flexible management of tool types	■ X	■ –
■ Filtered display of selectable tools	■ X	■ –
■ Sorting function	■ X	■ –
■ Column names	■ Sometimes with _	■ Sometimes with -
■ Copy function: Overwriting relevant tool data	■ X	■ X
■ Form view	■ Switchover with Screen Layout key	■ Switchover by soft key
■ Exchange of tool table between TNC 620 and iTNC 530	■ X	■ Not possible
Touch probe table for managing different 3-D touch probes	X	–
<b>Creating tool-usage file, checking the availability</b>	X	X
<b>Cutting data calculator:</b> Automatic calculation of spindle speed and feed rate	Simple cutting data calculator	Using stored technology tables
<b>Define any tables</b>	<ul style="list-style-type: none"> <li>■ Freely definable tables (.TAB files)</li> <li>■ Reading and writing with FN functions</li> <li>■ Definable via config. data</li> <li>■ The names of tables and table columns must start with a letter, and no arithmetic operators are permitted</li> <li>■ Reading and writing with SQL functions</li> </ul>	<ul style="list-style-type: none"> <li>■ Freely definable tables (.TAB files)</li> <li>■ Reading and writing with FN functions</li> </ul>



Function	TNC 620	iTNC 530															
<b>Constant contouring speed</b> relative to the path of the tool center or relative to the tool's cutting edge	X	X															
<b>Parallel operation:</b> Creating programs while another program is being run	X	X															
<b>Programming of counter axes</b>	X	X															
<b>Tilting the working plane (Cycle 19, PLANE function)</b>	X, option 8	X, option 8															
<b>Machining with a rotary table:</b>																	
<ul style="list-style-type: none"> <li>■ Programming of cylindrical contours as if in two axes                             <ul style="list-style-type: none"> <li>■ Cylindrical surface (Cycle 27)                                     <table style="width: 100%; border: none;"> <tr> <td style="width: 50%;"></td> <td style="width: 25%; text-align: center;">■ X, option 8</td> <td style="width: 25%; text-align: center;">■ X, option 8</td> </tr> </table> </li> <li>■ Cylinder surface, slot (Cycle 28)                                     <table style="width: 100%; border: none;"> <tr> <td style="width: 50%;"></td> <td style="width: 25%; text-align: center;">■ X, option 8</td> <td style="width: 25%; text-align: center;">■ X, option 8</td> </tr> </table> </li> <li>■ Cylinder surface, ridge (Cycle 29)                                     <table style="width: 100%; border: none;"> <tr> <td style="width: 50%;"></td> <td style="width: 25%; text-align: center;">■ X, option 8</td> <td style="width: 25%; text-align: center;">■ X, option 8</td> </tr> </table> </li> <li>■ Cylinder surface, external contour (Cycle 39)                                     <table style="width: 100%; border: none;"> <tr> <td style="width: 50%;"></td> <td style="width: 25%; text-align: center;">■ X, option 8</td> <td style="width: 25%; text-align: center;">■ X, option 8</td> </tr> </table> </li> </ul> </li> <li>■ Feed rate in mm/min or rev/min                             <table style="width: 100%; border: none;"> <tr> <td style="width: 50%;"></td> <td style="width: 25%; text-align: center;">■ X, option 8</td> <td style="width: 25%; text-align: center;">■ X, option 8</td> </tr> </table> </li> </ul>		■ X, option 8	■ X, option 8		■ X, option 8	■ X, option 8		■ X, option 8	■ X, option 8		■ X, option 8	■ X, option 8		■ X, option 8	■ X, option 8		
	■ X, option 8	■ X, option 8															
	■ X, option 8	■ X, option 8															
	■ X, option 8	■ X, option 8															
	■ X, option 8	■ X, option 8															
	■ X, option 8	■ X, option 8															
<b>Traverse in tool-axis direction</b>																	
<ul style="list-style-type: none"> <li>■ Manual operation (3-D ROT menu)                             <table style="width: 100%; border: none;"> <tr> <td style="width: 50%;"></td> <td style="width: 25%; text-align: center;">■ X</td> <td style="width: 25%; text-align: center;">■ X, FCL2 function</td> </tr> </table> </li> <li>■ During program interruption                             <table style="width: 100%; border: none;"> <tr> <td style="width: 50%;"></td> <td style="width: 25%; text-align: center;">■ X</td> <td style="width: 25%; text-align: center;">■ X</td> </tr> </table> </li> <li>■ With handwheel superimpositioning                             <table style="width: 100%; border: none;"> <tr> <td style="width: 50%;"></td> <td style="width: 25%; text-align: center;">■ X</td> <td style="width: 25%; text-align: center;">■ X, option 44</td> </tr> </table> </li> </ul>		■ X	■ X, FCL2 function		■ X	■ X		■ X	■ X, option 44								
	■ X	■ X, FCL2 function															
	■ X	■ X															
	■ X	■ X, option 44															
<b>Approaching and departing the contour:</b> Via a straight line or arc	X	X															
<b>Entry of feed rates:</b>																	
<ul style="list-style-type: none"> <li>■ <b>F</b> (mm/min), rapid traverse <b>FMAX</b> <table style="width: 100%; border: none;"> <tr> <td style="width: 50%;"></td> <td style="width: 25%; text-align: center;">■ X</td> <td style="width: 25%; text-align: center;">■ X</td> </tr> </table> </li> <li>■ <b>FU</b> (feed per revolution mm/1)                             <table style="width: 100%; border: none;"> <tr> <td style="width: 50%;"></td> <td style="width: 25%; text-align: center;">■ X</td> <td style="width: 25%; text-align: center;">■ X</td> </tr> </table> </li> <li>■ <b>FZ</b> (tooth feed rate)                             <table style="width: 100%; border: none;"> <tr> <td style="width: 50%;"></td> <td style="width: 25%; text-align: center;">■ X</td> <td style="width: 25%; text-align: center;">■ X</td> </tr> </table> </li> <li>■ <b>FT</b> (time in seconds for path)                             <table style="width: 100%; border: none;"> <tr> <td style="width: 50%;"></td> <td style="width: 25%; text-align: center;">■ –</td> <td style="width: 25%; text-align: center;">■ X</td> </tr> </table> </li> <li>■ <b>FMAXT</b> (only for active rapid traverse potentiometer: time in seconds for path)                             <table style="width: 100%; border: none;"> <tr> <td style="width: 50%;"></td> <td style="width: 25%; text-align: center;">■ –</td> <td style="width: 25%; text-align: center;">■ X</td> </tr> </table> </li> </ul>		■ X	■ X		■ X	■ X		■ X	■ X		■ –	■ X		■ –	■ X		
	■ X	■ X															
	■ X	■ X															
	■ X	■ X															
	■ –	■ X															
	■ –	■ X															
<b>FK free contour programming</b>																	
<ul style="list-style-type: none"> <li>■ Programming for workpiece drawings not dimensioned for NC programming                             <table style="width: 100%; border: none;"> <tr> <td style="width: 50%;"></td> <td style="width: 25%; text-align: center;">■ X, option 19</td> <td style="width: 25%; text-align: center;">■ X</td> </tr> </table> </li> <li>■ Conversion of FK program to Klartext conversational language                             <table style="width: 100%; border: none;"> <tr> <td style="width: 50%;"></td> <td style="width: 25%; text-align: center;">■ –</td> <td style="width: 25%; text-align: center;">■ X</td> </tr> </table> </li> </ul>		■ X, option 19	■ X		■ –	■ X											
	■ X, option 19	■ X															
	■ –	■ X															
<b>Program jumps:</b>																	
<ul style="list-style-type: none"> <li>■ Maximum number of labels                             <table style="width: 100%; border: none;"> <tr> <td style="width: 50%;"></td> <td style="width: 25%; text-align: center;">■ 65535</td> <td style="width: 25%; text-align: center;">■ 1000</td> </tr> </table> </li> <li>■ Subprograms                             <table style="width: 100%; border: none;"> <tr> <td style="width: 50%;"></td> <td style="width: 25%; text-align: center;">■ X</td> <td style="width: 25%; text-align: center;">■ X</td> </tr> <tr> <td style="padding-left: 20px;">■ Nesting depth for subprograms</td> <td style="width: 25%; text-align: center;">■ 20</td> <td style="width: 25%; text-align: center;">■ 6</td> </tr> </table> </li> <li>■ Program section repetitions                             <table style="width: 100%; border: none;"> <tr> <td style="width: 50%;"></td> <td style="width: 25%; text-align: center;">■ X</td> <td style="width: 25%; text-align: center;">■ X</td> </tr> </table> </li> <li>■ Any desired program as subroutine                             <table style="width: 100%; border: none;"> <tr> <td style="width: 50%;"></td> <td style="width: 25%; text-align: center;">■ X</td> <td style="width: 25%; text-align: center;">■ X</td> </tr> </table> </li> </ul>		■ 65535	■ 1000		■ X	■ X	■ Nesting depth for subprograms	■ 20	■ 6		■ X	■ X		■ X	■ X		
	■ 65535	■ 1000															
	■ X	■ X															
■ Nesting depth for subprograms	■ 20	■ 6															
	■ X	■ X															
	■ X	■ X															

Function	TNC 620	iTNC 530
<b>Q parameter programming:</b>		
■ Standard mathematical functions	■ X	■ X
■ Formula entry	■ X	■ X
■ String processing	■ X	■ X
■ Local Q parameters <b>QL</b>	■ X	■ X
■ Nonvolatile Q parameters <b>QR</b>	■ X	■ X
■ Changing parameters during program interruption	■ X	■ X
■ FN15:PRINT	■ –	■ X
■ FN25:PRESET	■ –	■ X
■ FN26:TABOPEN	■ X	■ X
■ FN27:TABWRITE	■ X	■ X
■ FN28:TABREAD	■ X	■ X
■ FN29: PLC LIST	■ X	■ –
■ FN31: RANGE SELECT	■ –	■ X
■ FN32: PLC PRESET	■ –	■ X
■ FN37:EXPORT	■ X	■ –
■ FN38: SEND	■ X	■ X
■ Save a file externally with <b>FN16</b>	■ X	■ X
■ <b>FN16</b> formatting: Left-aligned, right-aligned, string lengths	■ X	■ X
■ Write to LOG file with <b>FN16</b>	■ X	■ –
■ Displaying parameter contents in the additional status display	■ X	■ –
■ Displaying parameter contents during programming (Q-INFO)	■ X	■ X
■ <b>SQL</b> functions for writing and reading tables	■ X	■ –

Function	TNC 620	iTNC 530
<b>Graphic support</b>		
■ 2-D programming graphics	■ X	■ X
■ REDRAW function ( <b>REDRAW</b> )	■ –	■ X
■ Show grid lines as the background	■ X	■ –
■ 3-D line graphics	■ X	■ X
■ Test graphics (plan view, projection on 3 planes, 3-D view)	■ X, with option 20	■ X
■ High-resolution view	■ X	■ X
■ Tool display	■ X, with option 20	■ X
■ Adjusting the simulation speed	■ X, with option 20	■ X
■ Coordinates of line intersection for projection in 3 planes	■ –	■ X
■ Expanded zoom functions (mouse operation)	■ X, with option 20	■ X
■ Displaying frame for workpiece blank	■ X, with option 20	■ X
■ Displaying the depth value in plan view during mouse-over	■ X, with option 20	■ X
■ Deliberately stop test run ( <b>STOP AT</b> )	■ X, with option 20	■ X
■ Factor in tool change macro	■ X (differing to actual execution)	■ X
■ Program run graphics (plan view, projection in 3 planes, 3-D view)	■ X, with option 20	■ X
■ High-resolution view	■ X	■ X

Function	TNC 620	iTNC 530
<b>Datum tables:</b> Storing workpiece-specific datums	X	X
<b>Preset table</b>		
■ Preset management	■ X	■ X
■ Line 0 of the preset table can be edited manually	■ X	■ –
<b>Pallet management</b>		
■ Support of pallet files	■ X, option 22	■ X
■ Tool-oriented machining	■ X, option 22	■ X
■ Management of presets for a pallet in a table	■ X, option 22	■ X
<b>Returning to the contour</b>		
■ With mid-program startup	■ X	■ X
■ After program interruption	■ X	■ X
<b>Auto-start function</b>	X	X
<b>Teach-in:</b> Actual positions can be transferred to an NC program	X	X
<b>Enhanced file management</b>		
■ Creating multiple directories and subdirectories	■ X	■ X
■ Sorting function	■ X	■ X
■ Mouse operation	■ X	■ X
■ Selection of target directory by soft key	■ X	■ X
<b>Programming aids:</b>		
■ Help graphics for cycle programming	■ X	■ X
■ Animated help graphics when <b>PLANE/PATTERN DEF</b> function is selected	■ X	■ X
■ Help graphics for <b>PLANE/PATTERN DEF</b>	■ X	■ X
■ Context-sensitive help function for error messages	■ X	■ X
■ <b>TNCguide</b> , browser-based help system	■ X	■ X
■ Context-sensitive call of help system	■ X	■ X
■ Color highlighting of syntax elements	■ X	■ –
■ Calculator	■ X (scientific)	■ X (standard)
■ Comment blocks in NC program	■ X	■ X
■ Convert NC blocks to comments	■ X	■ –
■ Structure blocks in NC program	■ X	■ X
■ Structure view in test run	■ –	■ X
<b>Dynamic Collision Monitoring (DCM):</b>		
■ Collision monitoring in Automatic operation	■ –	■ X, option 40
■ Collision monitoring in Manual operation	■ –	■ X, option 40
■ Graphic depiction of the defined collision objects	■ –	■ X, option 40
■ Collision checking in test run	■ –	■ X, option 40
■ Fixture monitoring	■ –	■ X, option 40
■ Tool carrier management	■ X	■ X, option 40

Function	TNC 620	iTNC 530
<b>CAM support:</b>		
■ Loading of contours from DXF data	■ X, option 42	■ X, option 42
■ Load contours from Step data and Iges data	■ X, option 42	■ –
■ Loading of machining positions from DXF data	■ X, option 42	■ X, option 42
■ Load machining positions from Step data and Iges data	■ X, option 42	■ –
■ Offline filter for CAM files	■ –	■ X
■ Stretch filter	■ X	■ –
<b>MOD functions:</b>		
■ User parameters	■ Config data	■ Numerical structure
■ OEM help files with service functions	■ –	■ X
■ Data medium inspection	■ –	■ X
■ Load service packs	■ –	■ X
■ Setting the system time	■ X	■ X
■ Specify the axes for actual position capture	■ –	■ X
■ Definition of traverse range limits	■ X	■ X
■ Restricting external access	■ X	■ X
■ Configure counter	■ X	■ –
■ Switching the kinematics	■ X	■ X
<b>Calling fixed cycles:</b>		
■ With <b>M99</b> or <b>M89</b>	■ X	■ X
■ With <b>CYCL CALL</b>	■ X	■ X
■ With <b>CYCL CALL PAT</b>	■ X	■ X
■ With <b>CYC CALL POS</b>	■ X	■ X
<b>Special functions:</b>		
■ Create reverse program	■ –	■ X
■ Datum shift with <b>TRANS DATUM</b>	■ X	■ X
■ Adaptive Feed Control AFC	■ –	■ X, option 45
■ Define the counter with <b>FUNCTION COUNT</b>	■ X	■ –
■ Define the dwell time with <b>FUNCTION FEED</b>	■ X	■ –
■ Define the dwell time with <b>FUNCTION DWELL</b>	■ X	■ –
■ Determine the integration of the programmed coordinates with <b>FUNCTION PROG PATH</b>	■ X	■ –
■ Defining cycle parameters globally with <b>GLOBAL DEF</b>	■ X	■ X
■ Pattern definition with <b>PATTERN DEF</b>	■ X	■ X
■ Definition and processing of point tables	■ X	■ X
■ Simple contour formula <b>CONTOUR DEF</b>	■ X	■ X
<b>Functions for large molds and dies:</b>		
■ Global program settings (GS)	■ –	■ X, option 44
■ Expanded <b>M128: FUNCTION TCPM</b>	■ X	■ X

Function	TNC 620	iTNC 530
<b>Status displays:</b>		
■ Positions, spindle speed, feed rate	■ X	■ X
■ Larger depiction of position display, Manual operation	■ X	■ X
■ Additional status display, form view	■ X	■ X
■ Display of the handwheel path during machining with handwheel superimposing	■ X	■ X
■ Display of distance-to-go in a tilted system	■ X	■ X
■ Dynamic display of Q-parameter contents, definable number ranges	■ X	■ –
■ Machine manufacturer-specific additional status display via Python	■ X	■ X
■ Graphic display of residual run time	■ –	■ X
Individual color settings of user interface	–	X

**Comparison: Miscellaneous functions**

<b>M</b>	<b>Effect</b>	<b>TNC 620</b>	<b>iTNC 530</b>
<b>M00</b>	Program STOP/Spindle STOP/Coolant OFF	X	X
<b>M01</b>	Optional program STOP	X	X
<b>M02</b>	Stop program/Spindle STOP/Coolant OFF/ Clear status display (depending on machine parameter)/Return jump to block 1	X	X
<b>M03</b> M04 M05	Spindle ON clockwise Spindle ON counterclockwise Spindle STOP	X	X
<b>M06</b>	Tool change/Program run STOP (machine-specific function)/ Spindle STOP	X	X
<b>M08</b> M09	Coolant ON Coolant OFF	X	X
<b>M13</b> M14	Spindle ON clockwise/Coolant ON Spindle ON counterclockwise/Coolant on	X	X
<b>M30</b>	Same function as M02	X	X
<b>M89</b>	Free miscellaneous function <b>or</b> cycle call, modally effective (machine-specific function)	X	X
<b>M90</b>	Constant contouring speed at corners (not required at TNC 620)	–	X
<b>M91</b>	Within the positioning block: Coordinates are referenced to machine datum	X	X
<b>M92</b>	Within the positioning block: Coordinates are referenced to a position defined by machine manufacturer, e.g. tool change position	X	X
<b>M94</b>	Reduce the rotary axis display to a value below 360°	X	X
<b>M97</b>	Machine small contour steps	X	X
<b>M98</b>	Machine open contours completely	X	X
<b>M99</b>	Blockwise cycle call	X	X
<b>M101</b> M102	Automatic tool change with replacement tool if maximum tool life has expired Reset M101	X	X
<b>M103</b>	Reduce feed rate during plunging to factor F (percentage)	X	X
<b>M104</b>	Reactivate most recently set preset	– (recommended: Cycle 247)	X
<b>M105</b> M106	Machining with second $k_v$ factor Machining with first $k_v$ factor	–	X
<b>M107</b> M108	Suppress error message for replacement tools with oversize Reset M107	X	X
<b>M109</b>	Constant contouring speed at cutting edge (feed rate increase and reduction)	X	X
<b>M110</b> M111	Constant contouring speed at cutting edge (only feed rate reduction) Reset M109/M110	X	X

<b>M</b>	<b>Effect</b>	<b>TNC 620</b>	<b>iTNC 530</b>
<b>M112</b> M113	Enter contour transitions between any two contour transitions Reset M112	– (recommended: Cycle 32)	X
<b>M114</b> M115	Automatic compensation of machine geometry when working with tilted axes Reset M114	– (recommended: M128, TCPM)	X, option 8
<b>M116</b> M117	Feed rate on rotary tables in mm/min Reset M116	X, option 8	X, option 8
<b>M118</b>	Superimpose handwheel positioning during program run	X, option 21	X
<b>M120</b>	Pre-calculate the radius-compensated contour (LOOK AHEAD)	X, option 21	X
<b>M124</b>	Contour filter	– (possible via user parameters)	X
<b>M126</b> M127	Shorter-path traverse of rotary axes Reset M126	X	X
<b>M128</b> M129	Maintaining the position of the tool tip when positioning tilted axes (TCPM) Reset M128	X, option 9	X, option 9
<b>M130</b>	Within the positioning block: Points are referenced to the untilted coordinate system	X	X
<b>M134</b> M135	Precision stop at non-tangential contour transitions when positioning with rotary axes Reset M134	–	X
<b>M136</b> M137	Feed rate F in millimeters per spindle revolution Reset M136	X	X
<b>M138</b>	Selection of tilted axes	X	X
<b>M140</b>	Retraction from the contour in the tool-axis direction	X	X
<b>M141</b>	Suppress touch probe monitoring	X	X
<b>M142</b>	Delete modal program information	–	X
<b>M143</b>	Delete basic rotation	X	X
<b>M144</b> M145	Compensating the machine's kinematic configuration for ACTUAL/NOMINAL positions at end of block Reset M144	X, option 9	X, option 9
<b>M148</b> M149	Automatically retract tool from the contour at an NC stop Reset M148	X	X
<b>M150</b>	Suppress limit switch message	– (possible via FN 17)	X
<b>M197</b>	Rounding the corners	X	–
<b>M200</b> - <b>M204</b>	Laser cutting functions	–	X



**Comparator: Cycles**

Cycle	TNC 620	iTNC 530
1 <b>PECKING</b> (recommended: Cycle 200, 203, 205)	–	X
2 <b>TAPPING</b> (recommended: Cycle 206, 207, 208)	–	X
3 <b>SLOT MILLING</b> (recommended: Cycle 253)	–	X
4 <b>POCKET MILLING</b> (recommended: Cycle 251)	–	X
5 <b>CIRCULAR POCKET</b> (recommended: Cycle 252)	–	X
6 <b>ROUGH-OUT</b> (SL I, recommended: SL II, Cycle 22)	–	X
7 <b>DATUM SHIFT</b>	X	X
8 <b>MIRROR IMAGE</b>	X	X
9 <b>DWELL TIME</b>	X	X
10 <b>ROTATION</b>	X	X
11 <b>SCALING</b>	X	X
12 <b>PGM CALL</b>	X	X
13 <b>ORIENTATION</b>	X	X
14 <b>CONTOUR GEOMETRY</b>	X	X
15 <b>PILOT DRILLING</b> (SL I, recommended: SL II, Cycle 21)	–	X
16 <b>CONTOUR MILLING</b> (SL I, recommended: SL II, Cycle 24)	–	X
17 <b>RIGID TAPPING</b> (recommended: Cycle 207, 209)	–	X
18 <b>THREAD CUTTING</b>	X	X
19 <b>WORKING PLANE</b>	X, option 8	X, option 8
20 <b>CONTOUR DATA</b>	X, option 19	X
21 <b>PILOT DRILLING</b>	X, option 19	X
22 <b>ROUGH-OUT</b>	X, option 19	X
23 <b>FLOOR FINISHING</b>	X, option 19	X
24 <b>SIDE FINISHING</b>	X, option 19	X
25 <b>CONTOUR TRAIN</b>	X, option 19	X
26 <b>AXIS-SPECIFIC SCALING</b>	X	X
27 <b>CYLINDER SURFACE</b>	X, option 8	X, option 8
28 <b>CYLINDER SURFACE</b>	X, option 8	X, option 8
29 <b>CYL SURFACE RIDGE</b>	X, option 8	X, option 8
30 <b>RUN CAM DATA</b>	–	X
32 <b>TOLERANCE</b>	X	X
39 <b>CYL. SURFACE CONTOUR</b>	X, option 8	X, option 8
200 <b>DRILLING</b>	X	X
201 <b>REAMING</b>	X, option 19	X
202 <b>BORING</b>	X, option 19	X
203 <b>UNIVERSAL DRILLING</b>	X, option 19	X
204 <b>BACK BORING</b>	X, option 19	X

<b>Cycle</b>	<b>TNC 620</b>	<b>iTNC 530</b>
205 <b>UNIVERSAL PECKING</b>	X, option 19	X
206 <b>TAPPING</b>	X	X
207 <b>RIGID TAPPING</b>	X	X
208 <b>BORE MILLING</b>	X, option 19	X
209 <b>TAPPING W/ CHIP BRKG</b>	X, option 19	X
210 <b>SLOT RECIP. PLNG</b> (recommended: Cycle 253, option 19)	–	X
211 <b>CIRCULAR SLOT</b> (recommended: Cycle 254, option 19)	–	X
212 <b>POCKET FINISHING</b> (recommended: Cycle 251, option 19)	–	X
213 <b>STUD FINISHING</b> (recommended: Cycle 256, option 19)	–	X
214 <b>C. POCKET FINISHING</b> (recommended: Cycle 252, option 19)	–	X
215 <b>C. STUD FINISHING</b> (recommended: Cycle 257, option 19)	–	X
220 <b>POLAR PATTERN</b>	X, option 19	X
221 <b>CARTESIAN PATTERN</b>	X, option 19	X
225 <b>ENGRAVING</b>	X, option 19	X
230 <b>MULTIPASS MILLING</b> (recommended: Cycle 233, option 19)	–	X
231 <b>RULED SURFACE</b>	–	X
232 <b>FACE MILLING</b>	X, option 19	X
233 <b>FACE MILLING</b>	X, option 19	–
240 <b>CENTERING</b>	X, option 19	X
241 <b>SINGLE-LIP D.H.DRLNG</b>	X, option 19	X
247 <b>PRESETTING</b>	X	X
251 <b>RECTANGULAR POCKET</b>	X, option 19	X
252 <b>CIRCULAR POCKET</b>	X, option 19	X
253 <b>SLOT MILLING</b>	X, option 19	X
254 <b>CIRCULAR SLOT</b>	X, option 19	X
256 <b>RECTANGULAR STUD</b>	X, option 19	X
257 <b>CIRCULAR STUD</b>	X, option 19	X
258 <b>POLYGON STUD</b>	X, option 19	–
262 <b>THREAD MILLING</b>	X, option 19	X
263 <b>THREAD MLLNG/CNTSNKG</b>	X, option 19	X
264 <b>THREAD DRILLNG/MLLNG</b>	X, option 19	X
265 <b>HEL. THREAD DRLG/MLG</b>	X, option 19	X
267 <b>OUTSIDE THREAD MLLNG</b>	X, option 19	X
270 <b>CONTOUR TRAIN DATA</b> for defining the behavior of Cycle 25	X	X
275 <b>TROCHOIDAL SLOT</b>	X, option 19	X
276 <b>THREE-D CONT. TRAIN</b>	X, option 19	X
290 <b>INTERPOLATION TURNING</b>	–	X, option 96

### Comparison: Touch probe cycles in the Manual operation and Electronic handwheel modes of operation

Cycle	TNC 620	iTNC 530
Touch-probe table for managing 3-D touch probes	X	–
Calibrating the effective length	X, option 17	X
Calibrating the effective radius	X, option 17	X
Measuring a basic rotation using a line	X, option 17	X
Setting the preset on any axis	X, option 17	X
Setting a corner as preset	X, option 17	X
Setting a circle center as preset	X, option 17	X
Setting a center line as preset	X, option 17	X
Measuring a basic rotation using two holes/cylindrical studs	X, option 17	X
Setting the preset using four holes/cylindrical studs	X, option 17	X
Setting the circle center using three holes/cylindrical studs	X, option 17	X
Determine and offset misalignment of a plane	X, option 17	–
Support of mechanical touch probes by manually capturing the current position	By soft key or hard key	By hard key
Write measurement values to the preset table	X, option 17	X
Write measurement values to the datum table	X, option 17	X

## Comparison: Probing system cycles for automatic workpiece control

Cycle	TNC 620	iTNC 530
0 REF. PLANE	X, option 17	X
1 POLAR PRESET	X, option 17	X
2 CALIBRATE TS	–	X
3 MEASURING	X, option 17	X
4 MEASURING IN 3-D	X, option 17	X
9 CALIBRATE TS LENGTH	–	X
30 CALIBRATE TT	X, option 17	X
31 CAL. TOOL LENGTH	X, option 17	X
32 CAL. TOOL RADIUS	X, option 17	X
33 MEASURE TOOL	X, option 17	X
400 BASIC ROTATION	X, option 17	X
401 ROT OF 2 HOLES	X, option 17	X
402 ROT OF 2 STUDS	X, option 17	X
403 ROT IN ROTARY AXIS	X, option 17	X
404 SET BASIC ROTATION	X, option 17	X
405 ROT IN C AXIS	X, option 17	X
408 SLOT CENTER PRESET	X, option 17	X
409 RIDGE CENTER PRESET	X, option 17	X
410 PRESET INSIDE RECTAN	X, option 17	X
411 PRESET OUTS. RECTAN	X, option 17	X
412 PRESET INSIDE CIRCLE	X, option 17	X
413 PRESET OUTS. CIRCLE	X, option 17	X
414 PRESET OUTS. CORNER	X, option 17	X
415 PRESET INSIDE CORNER	X, option 17	X
416 PRESET CIRCLE CENTER	X, option 17	X
417 PRESET IN TS AXIS	X, option 17	X
418 PRESET FROM 4 HOLES	X, option 17	X
419 PRESET IN ONE AXIS	X, option 17	X
420 MEASURE ANGLE	X, option 17	X
421 MEASURE HOLE	X, option 17	X
422 MEAS. CIRCLE OUTSIDE	X, option 17	X
423 MEAS. RECTAN. INSIDE	X, option 17	X
424 MEAS. RECTAN. OUTS.	X, option 17	X
425 MEASURE INSIDE WIDTH	X, option 17	X
426 MEASURE RIDGE WIDTH	X, option 17	X
427 MEASURE COORDINATE	X, option 17	X

<b>Cycle</b>	<b>TNC 620</b>	<b>iTNC 530</b>
430 MEAS. BOLT HOLE CIRC	X, option 17	X
431 MEASURE PLANE	X, option 17	X
440 MEASURE AXIS SHIFT	–	X
441 FAST PROBING	X, option 17	X
450 SAVE KINEMATICS	X, option 48	X, option 48
451 MEASURE KINEMATICS	X, option 48	X, option 48
452 PRESET COMPENSATION	X, option 48	X, option 48
453 KINEMATICS GRID	X, option 48, option 52	–
460 CALIBRATION OF TS ON A SPHERE	X, option 17	X
461 TS CALIBRATION OF TOOL LENGTH	X, option 17	X
462 CALIBRATION OF A TS IN A RING	X, option 17	X
463 TS CALIBRATION ON STUD	X, option 17	X
480 CALIBRATE TT	X, option 17	X
481 CAL. TOOL LENGTH	X, option 17	X
482 CAL. TOOL RADIUS	X, option 17	X
483 MEASURE TOOL	X, option 17	X
484 CALIBRATE IR TT	X, option 17	X
600 GLOBAL WORKING SPACE	X	–
601 LOCAL WORKING SPACE	X	–

## Comparison: Differences in programming

Function	TNC 620	iTNC 530
Switching the operating mode while a block is being edited	Permitted	Permitted
<b>File handling:</b>		
■ <b>Save file</b> function	■ Available	■ Available
■ <b>Save file as</b> function	■ Available	■ Available
■ Discard changes	■ Available	■ Available
<b>File management:</b>		
■ Mouse operation	■ Available	■ Available
■ Sorting function	■ Available	■ Available
■ Entry of name	■ Opens <b>Select file</b> pop-up window	■ Synchronizes the cursor
■ Support of key combinations	■ Not available	■ Available
■ Favorites Management	■ Not available	■ Available
■ Configuration of column structure	■ Not available	■ Available
■ Soft-key arrangement	■ Slightly different	■ Slightly different
Skip block function	Available	Available
Selecting a tool from the table	Selection via split-screen menu	Selection in a pop-up window
Programming special functions with the <b>SPEC FCT</b> key	Pressing the key opens a soft-key row as a submenu. To exit the submenu, press the <b>SPEC FCT</b> key again; then the control shows the last active soft-key row	Pressing the key adds the soft-key row as the last row. To exit the menu, press the <b>SPEC FCT</b> key again; then the control shows the last active soft-key row
Programming approach and departure motions with the <b>APPR DEP</b> key	Pressing the key opens a soft-key row as a submenu. To exit the submenu, press the <b>APPR DEP</b> key again; then the control shows the last active soft-key row	Pressing the key adds the soft-key row as the last row. To exit the menu, press the <b>APPR DEP</b> key again; then the control shows the last active soft-key row
Pressing the hard key <b>END</b> with active <b>CYCLE DEF</b> and <b>TOUCH PROBE</b> menus	Terminates the editing process and calls the file manager	Exits the respective menu
Calling the file manager while the <b>CYCLE DEF</b> and <b>TOUCH PROBE</b> menus are active	Terminates the editing process and calls the file manager. The respective soft-key row remains selected when the file manager is exited	<b>Key non-functional</b> error message
Calling the file manager while <b>CYCL CALL</b> , <b>SPEC FCT</b> , <b>PGM CALL</b> and <b>APPR/DEP</b> menus are active	Terminates the editing process and calls the file manager. The respective soft-key row remains selected when the file manager is exited	Terminates the editing process and calls the file manager. The basic soft-key row is selected when the file manager is exited

Function	TNC 620	iTNC 530
<b>Datum table:</b>		
■ Sorting function by values within an axis	■ Available	■ Not available
■ Resetting the table	■ Available	■ Not available
■ Hiding axes that are not present	■ Available	■ Available
■ Switching the list/form view	■ Switch via the screen layout key	■ Switchover by toggle soft key
■ Inserting individual line	■ Allowed everywhere, renumbering possible after request. Empty line is inserted, must be filled with zeros manually	■ Only allowed at the end of the table. Line with value 0 in all columns is inserted
■ Transfer of actual position values on individual axis to the datum table using the keys	■ Not available	■ Available
■ Transfer of actual position values on all active axes to the datum table using the keys	■ Not available	■ Available
■ Capturing the last positions measured by TS using the keys	■ Not available	■ Available
<b>FK free contour programming:</b>		
■ Programming of parallel axes	■ With X/Y coordinates, independent of machine type; switchover with <b>FUNCTION PARAXMODE</b>	■ Machine-dependent with the existing parallel axes
■ Automatic correction of relative references	■ Relative references in contour subprograms are not corrected automatically	■ All relative references are corrected automatically
<b>Q-parameter programming:</b>		
■ Q-parameter formula with SGN	$Q12 = \text{SGN } Q50$ <ul style="list-style-type: none"> <li>■ if <math>Q50 = 0</math> then <math>Q12 = 0</math></li> <li>■ if <math>Q50 &gt; 0</math> then <math>Q12 = 1</math></li> <li>■ if <math>Q50 &lt; 0</math> then <math>Q12 = -1</math></li> </ul>	$Q12 = \text{SGN } Q50$ <ul style="list-style-type: none"> <li>■ if <math>Q50 \geq 0</math> then <math>Q12 = 1</math></li> <li>■ if <math>Q50 &lt; 0</math> then <math>Q12 = -1</math></li> </ul>

Function	TNC 620	iTNC 530
<b>Handling of error messages:</b>		
<ul style="list-style-type: none"> <li>■ Help with error messages</li> <li>■ Switching the operating mode while help menu is active</li> <li>■ Selecting the background operating mode while help menu is active</li> <li>■ Identical error messages</li> <li>■ Acknowledgment of error messages</li> <li>■ Access to protocol functions</li> <li>■ Saving service files</li> </ul>	<ul style="list-style-type: none"> <li>■ Call via <b>ERR</b> key</li> <li>■ Help menu is closed when the operating mode is switched</li> <li>■ Help menu is closed when F12 is used for switching</li> <li>■ Are collected in a list</li> <li>■ Every error message (even if it is displayed more than once) must be acknowledged, the <b>DELETE ALL</b> function is available</li> <li>■ Log and powerful filter functions (errors, keystrokes) are available</li> <li>■ Available. No service file is created when the system crashes</li> </ul>	<ul style="list-style-type: none"> <li>■ Call via <b>HELP</b> key</li> <li>■ Operating mode switchover is not allowed (key is non-functional)</li> <li>■ Help menu remains open when F12 is used for switching</li> <li>■ Are displayed only once</li> <li>■ Error message to be acknowledged only once</li> <li>■ Complete log without filter functions available</li> <li>■ Available. A service file is automatically created when the system crashes</li> </ul>
<b>Find function:</b>		
<ul style="list-style-type: none"> <li>■ List of words recently searched for</li> <li>■ Show elements of active block</li> <li>■ Show list of all available NC blocks</li> </ul>	<ul style="list-style-type: none"> <li>■ Not available</li> <li>■ Not available</li> <li>■ Not available</li> </ul>	<ul style="list-style-type: none"> <li>■ Available</li> <li>■ Available</li> <li>■ Available</li> </ul>
Starting the search function with the up/down arrow keys when highlighted	Works up to max. 50,000 blocks, can be set via configuration datum	No limitation regarding program length
<b>Programming graphics:</b>		
<ul style="list-style-type: none"> <li>■ True-to-scale display of grid</li> <li>■ Editing contour subprograms in SLII cycles with <b>AUTO DRAW ON</b></li> <li>■ Moving the zoom window</li> </ul>	<ul style="list-style-type: none"> <li>■ Available</li> <li>■ With error messages, in the main program the cursor is on the <b>CYCL CALL</b> block</li> <li>■ Repeat function not available</li> </ul>	<ul style="list-style-type: none"> <li>■ Not available</li> <li>■ If error messages occur, the cursor is on the block in the contour subprogram responsible for the error</li> <li>■ Repeat function available</li> </ul>



Function	TNC 620	iTNC 530
<b>Programming minor axes:</b>		
<ul style="list-style-type: none"> <li>■ Syntax <b>FUNCTION PARAXCOMP</b>: Define the behavior of the display and the paths of traverse</li> <li>■ Syntax <b>FUNCTION PARAXMODE</b>: Define the assignment of the parallel axes to be traversed</li> </ul>	<ul style="list-style-type: none"> <li>■ Available</li> <li>■ Available</li> </ul>	<ul style="list-style-type: none"> <li>■ Not available</li> <li>■ Not available</li> </ul>
<b>Programming OEM cycles</b>		
<ul style="list-style-type: none"> <li>■ Access to table data</li> <li>■ Access to machine parameters</li> <li>■ Creating interactive cycles with <b>CYCLE QUERY</b>, e.g. touch probe cycles in Manual Operation</li> </ul>	<ul style="list-style-type: none"> <li>■ Via <b>SQL</b> commands and via <b>FN 17/FN 18</b> or <b>TABREAD-TABWRITE</b> functions</li> <li>■ With the <b>CFGREAD</b> function</li> <li>■ Available</li> </ul>	<ul style="list-style-type: none"> <li>■ Via <b>FN 17/FN 18</b> or <b>TABREAD-TABWRITE</b> functions</li> <li>■ Via <b>FN 18</b> functions</li> <li>■ Not available</li> </ul>

**Comparison: Differences in Test Run, functionality**

Function	TNC 620	iTNC 530
Entering a program with the <b>GOTO</b> key	Function only possible if the <b>START SINGLE</b> soft key was not pressed	Function also possible after <b>START SINGLE</b>
Calculation of machining time	Each time the simulation is repeated by pressing the <b>START</b> soft key, the machining time is totaled	Each time the simulation is repeated by pressing the <b>START</b> soft key, time calculation starts at 0
Single block	With point pattern cycles and <b>CYCL CALL PAT</b> , the control stops after each point	Point pattern cycles and <b>CYCL CALL PAT</b> are handled by the control as a single block

### Comparison: Differences in Test Run, operation

Function	TNC 620	iTNC 530
Arrangement of soft-key rows and soft keys within the rows	Arrangement of soft-key rows and soft-keys varies depending on the active screen layout.	
Zoom function	Each sectional plane can be selected by individual soft keys	Sectional plane can be selected via three toggle soft keys
Machine-specific miscellaneous functions M	Lead to error messages if they are not integrated in the PLC	Are ignored during Test Run
Displaying/editing the tool table	Function available via soft key	Function not available
Tool depiction	<ul style="list-style-type: none"> <li>■ red: engaged</li> <li>■ blue: not engaged</li> </ul>	<ul style="list-style-type: none"> <li>■ red: engaged</li> <li>■ green: not engaged</li> </ul>
3-D view: Transparent display of workpiece	Available	Function not available
3-D view: Transparent display of workpiece	Available	Function not available
3-D view: Display tool path	Available	Function not available
Adjustable model quality	Available	Function not available

## Comparison: Differences in Manual Operation, functionality

Function	TNC 620	iTNC 530
Jog increment function	The jog increment can be defined separately for linear and rotary axes	The jog increment applies for both linear and rotary axes
Preset table	<p>Basic transformation (translation and rotation) of machine table system to workpiece system via the <b>X</b>, <b>Y</b> and <b>Z</b> columns, as well as spatial angles <b>SPA</b>, <b>SPB</b> and <b>SPC</b>.</p> <p>In addition, the <b>X_OFFS</b> to <b>W_OFFS</b> columns can be used to define the axis offset of each individual axis. The function of the axis offsets can be configured.</p> <p>Line 0 can also be edited manually.</p>	<p>Basic transformation (translation) of machine table system to workpiece system via the columns <b>X</b>, <b>Y</b> and <b>Z</b>, as well as a <b>ROT</b> basic rotation in the working plane (rotation).</p> <p>In addition, columns <b>A</b> to <b>W</b> can be used to define presets on the rotary and parallel axes.</p> <p>Line 0 can only be edited by manual probing cycles.</p>
Behavior when presetting	<p>Presetting in a rotary axis has the same effect as an axis offset. This offset is also effective for kinematics calculations and during tilting of the working plane.</p> <p>In machine parameter <b>preset-ToAlignAxis</b> (no. 300203) your machine tool builder specifies for each axis what effect an offset of a rotational axis has on the preset.</p> <ul style="list-style-type: none"> <li>■ <b>True</b> (default): The offset is subtracted from the axis value before the calculation of the kinematics</li> <li>■ <b>False</b>: The offset only affects the position display</li> </ul>	<p>Rotary axis offsets defined by machine parameters do not influence the axis positions that were defined in the Tilt working plane function.</p> <p>MP7500, bit 3 permits you to define whether the current rotary axis position relative to the machine datum is taken into account or whether the first rotary axis (usually the C axis) is assumed to be in 0° position.</p>
Presetting	Only after a reference run is it possible to set a preset or to modify a preset via the preset table.	A preset can be set or modified via the preset table before a reference run.
<b>Handling of the preset table:</b>		
<ul style="list-style-type: none"> <li>■ Preset table that depends on the range of traverse</li> </ul>	<ul style="list-style-type: none"> <li>■ Available</li> </ul>	<ul style="list-style-type: none"> <li>■ Available</li> </ul>
Definition of feed-rate limitation	Feed-rate limitation can be defined separately for linear and rotary axes	Only one feed-rate limitation can be defined for linear and rotary axes

### Comparison: Differences in Manual Operation, operation

Function	TNC 620	iTNC 530
Capturing the position values from mechanical probes	Confirm actual position with a soft key or hard key	Actual-position capture by hard key
Exiting the Touch Probe Functions menu	Using the <b>END</b> soft key or the <b>END</b> hard key	Using the <b>END</b> soft key or the <b>END</b> hard key

### Comparison: Differences in Program Run, operation

Function	TNC 620	iTNC 530
Arrangement of soft-key rows and soft keys within the rows	Arrangement of soft-key rows and soft-keys differs according to the active screen layout.	
Operating mode switchover after program run has been suspended by switching to the <b>Program run, single block</b> operating mode and canceled with <b>INTERNAL STOP</b>	When you return to the <b>Program run, full sequence</b> mode: error message <b>Current block not selected</b> . Use mid-program startup to select the point of interruption	Switching the operating mode is allowed, modal information is saved, program run can be continued by pressing NC start
<b>GOTO</b> is used to go to FK sequences after program run was interrupted there before switching the operating mode	Error message <b>FK programming: Undefined starting position</b> Entering with mid-program startup is permitted	GOTO allowed
<b>Mid-program startup:</b>		
Switching the screen layout for mid-program startup	Only possible, if startup position has already been approached	Possible in all operating states
Error messages	Error messages are still active after the error has been corrected and must be acknowledged separately	Error messages are sometimes acknowledged automatically after the error has been corrected
Point patterns in single block	With point pattern cycles and <b>CYCL CALL PAT</b> , the control stops after each point.	Point pattern cycles and <b>CYCL CALL PAT</b> are handled by the control as a single block

**Comparison: Differences in Program Run, traverse movements**

**NOTICE**

**Danger of collision!**

NC programs that were created older controls can lead to unexpected axis movements or error messages on current control models. Danger of collision during machining!

- ▶ Check the NC program or program section using the graphic simulation
- ▶ Carefully test the NC program or program section in the **Program run, single block** operating mode
- ▶ Pay attention to the following known differences (the list below might not be complete!)

Function	TNC 620	iTNC 530
Handwheel-superimposed traversing with <b>M118</b>	Effective in the machine coordinate system	Effective in the machine coordinate system
Deleting basic rotation with <b>M143</b>	<b>M143</b> deletes the entries in columns <b>SPA</b> , <b>SPB</b> , and <b>SPC</b> in the preset table; reactivating the corresponding preset table row does <b>not</b> activate the deleted basic rotation	<b>M143</b> does <b>not</b> delete the entry in the <b>ROT</b> column in the preset table; reactivating the corresponding preset table row activates the deleted basic rotation
Scaling approach/departure movements ( <b>APPR/DEP/RND</b> )	Axis-specific scaling factor is allowed, radius is not scaled	Error message
Approach/departure with <b>APPR/DEP</b>	Error message if <b>R0</b> is programmed for <b>APPR/DEP LN</b> or <b>APPR/DEP CT</b>	Tool radius 0 and compensation direction <b>RR</b> are assumed
Approach/departure with <b>APPR/DEP</b> if contour elements with length 0 are defined	Contour elements with length 0 are ignored. The approach/departure movements are calculated for the first and last valid contour element	An error message is issued if a contour element with length 0 is programmed after the <b>APPR</b> block (relative to the first contour point programmed in the <b>APPR</b> block) For a contour element with length 0 before a <b>DEP</b> block, the iTNC 530 does not issue an error message, but uses the last valid contour element to calculate the departure movement

Function	TNC 620	iTNC 530
Effect of Q parameters	<b>Q60 to Q99 (QS60 to QS99)</b> are always local.	<b>Q60 to Q99 (QS60 to QS99)</b> are local or global, depending on MP7251 in converted cycle programs (.cyc). Nested calls may cause problems
Automatic cancelation of tool radius compensation	<ul style="list-style-type: none"> <li>■ Block with <b>R0</b></li> <li>■ <b>DEP</b> block</li> <li>■ Program selection</li> <li>■ <b>END PGM</b></li> </ul>	<ul style="list-style-type: none"> <li>■ Block with <b>R0</b></li> <li>■ <b>DEP</b> block</li> <li>■ Program selection</li> <li>■ Programming of Cycle 10 <b>ROTATION</b></li> <li>■ <b>PGM CALL</b></li> </ul>
NC blocks with <b>M91</b>	No consideration of tool radius compensation	Consideration of tool radius compensation
Behavior with <b>M120 LA1</b>	No effect on processing, as the control interprets the input internally as an <b>LA0</b>	Possible undesired effect on processing, as the control interprets the entry internally as an <b>LA2</b>
Block scan in a point table	The tool is positioned above the next position to be machined	The tool is positioned above the last position that has been completely machined
Empty <b>CC</b> block (pole adoption from last tool position) in the NC program	Last positioning block in the working plane must contain both coordinates of the working plane	Last positioning block in the working plane does not necessarily need to contain both coordinates of the working plane. Can cause problems with <b>RND</b> or <b>CHF</b> blocks
Axis-specific scaling of <b>RND</b> block	<b>RND</b> block is scaled, the result is an ellipse	Error message is issued
Reaction if a contour element with length 0 is defined before or after a <b>RND</b> or <b>CHF</b> block	Error message is issued	<p>Error message is issued if a contour element with length 0 is located before the <b>RND</b> or <b>CHF</b> block</p> <p>Contour element with length 0 is ignored if the contour element with length 0 is located after the <b>RND</b> or <b>CHF</b> block</p>

Function	TNC 620	iTNC 530
Circle programming with polar coordinates	The incremental rotation angle <b>IPA</b> and the direction of rotation <b>DR</b> must have the same sign. Otherwise, an error message will be issued	The algebraic sign of the direction of rotation is used if the sign defined for <b>DR</b> differs from the one defined for <b>IPA</b>
Tool radius compensation on circular arc or helix with angular length = 0	The transition between the adjacent elements of the arc/helix is generated. Also, the tool axis motion is executed right before this transition. If the element is the first or last element to be corrected, the next or previous element is dealt with in the same way as the first or last element to be corrected	The equidistant line of the arc/helix is used for generating the tool path
Compensation of tool length in the position display	The values <b>L</b> and <b>DL</b> from the tool table and the value <b>DL</b> from the <b>TOOL CALL</b> block are taken into account in the position display	The values <b>L</b> and <b>DL</b> from the tool table are taken into account in the position display
<b>SLII Cycles 20 to 24:</b>		
<ul style="list-style-type: none"> <li>■ Number of definable contour elements</li> <li>■ Define the working plane</li> <li>■ Position at end of SL cycle</li> </ul>	<ul style="list-style-type: none"> <li>■ Max. 16384 blocks in up to 12 subcontours</li> <li>■ Tool axis in <b>TOOL CALL</b> block defines the working plane</li> <li>■ With the <b>posAfterContPocket</b> (no. 201007) parameter, you can define whether the end position is above the last programmed position, or whether the tool moves to clearance height in the tool axis</li> <li>■ If the tool moves to clearance height in the tool axis, both coordinates must be programmed with the first traverse movement</li> </ul>	<ul style="list-style-type: none"> <li>■ Max. 8192 contour elements in up to 12 subcontours, no restrictions for subcontour</li> <li>■ The axes of the first positioning block in the first subcontour define the working plane</li> <li>■ With MP7420, you can define whether the end position is above the last programmed position, or whether the tool moves only to clearance height in the tool axis</li> <li>■ If the tool moves to clearance height in the tool axis, one coordinate must be programmed with the first traverse movement</li> </ul>

Function	TNC 620	iTNC 530
<b>SLII Cycles 20 to 24:</b>		
<ul style="list-style-type: none"> <li>■ Behavior with islands not contained in pockets</li> <li>■ Set operations for SL cycles with complex contour formulas</li> <li>■ Radius compensation is active during <b>CYCL CALL</b></li> <li>■ Paraxial positioning blocks in contour subprogram</li> <li>■ Miscellaneous functions <b>M</b> in contour subprogram</li> </ul>	<ul style="list-style-type: none"> <li>■ Cannot be defined with complex contour formula</li> <li>■ Real set operation possible</li> <li>■ Error message is issued</li> <li>■ Error message is issued</li> <li>■ Error message is issued</li> </ul>	<ul style="list-style-type: none"> <li>■ Restricted definition in complex contour formula is possible</li> <li>■ Only restricted performance of real set operation possible</li> <li>■ Radius compensation is canceled, program is executed</li> <li>■ Program is executed</li> <li>■ M functions are ignored</li> </ul>
<b>Cylinder surface machining in general:</b>		
<ul style="list-style-type: none"> <li>■ Contour definition</li> <li>■ Offset definition on cylinder surface</li> <li>■ Offset definition for basic rotation</li> <li>■ Circle programming with C/CC</li> <li>■ <b>APPR/DEP</b> blocks in contour definition</li> </ul>	<ul style="list-style-type: none"> <li>■ With X/Y coordinates, independent of machine type</li> <li>■ With datum shift in X/Y, regardless of machine type</li> <li>■ Function available</li> <li>■ Function available</li> <li>■ Function not available</li> </ul>	<ul style="list-style-type: none"> <li>■ Machine-dependent, with existing rotary axes</li> <li>■ Machine-specific datum shift in rotary axes</li> <li>■ Function not available</li> <li>■ Function not available</li> <li>■ Function available</li> </ul>
<b>Cylinder surface machining with Cycle 28:</b>		
<ul style="list-style-type: none"> <li>■ Complete roughing-out of slot</li> <li>■ Definable tolerance</li> </ul>	<ul style="list-style-type: none"> <li>■ Function available</li> <li>■ Function available</li> </ul>	<ul style="list-style-type: none"> <li>■ Function not available</li> <li>■ Function available</li> </ul>
<b>Cylinder surface machining with Cycle 29</b>		
	Direct plunging to contour of ridge	Circular approach to contour of ridge
<b>Cycles 25x for pockets, studs and slots:</b>		
<ul style="list-style-type: none"> <li>■ Plunging movements</li> </ul>	In limit ranges (geometrical conditions of tool/contour) error messages are triggered if plunging movements lead to unreasonable/critical behavior	In limit ranges (geometrical conditions of tool/contour), vertical plunging is used if required



Function	TNC 620	iTNC 530
<b>PLANE function:</b>		
<ul style="list-style-type: none"> <li>■ <b>TABLE ROT/COORD ROT</b></li> </ul>	<p>Effect:</p> <ul style="list-style-type: none"> <li>■ The transformation types are effective on all free rotary axes</li> <li>■ The control does not always position the free rotary axis with <b>TABLE ROT</b>, but depending on the current position, the programmed spatial angle and the machine kinematics</li> </ul> <p>Default with missing selection:</p> <ul style="list-style-type: none"> <li>■ <b>COORD ROT</b> is used</li> </ul>	<p>Effect</p> <ul style="list-style-type: none"> <li>■ The transformation types are only effective with a C rotary axis</li> <li>■ With <b>TABLE ROT</b> the control always positions the rotary axis</li> </ul> <p>Default with missing selection:</p> <ul style="list-style-type: none"> <li>■ <b>COORD ROT</b> is used</li> </ul>
<ul style="list-style-type: none"> <li>■ Machine is configured for axis angle</li> <li>■ Programming an incremental spatial angle according to <b>PLANE AXIAL</b></li> <li>■ Programming an incremental axis angle according to <b>PLANE SPATIAL</b> if the machine is configured for spatial angles</li> <li>■ Programming of <b>PLANE</b> functions with active Cycle 8 <b>MIRROR IMAGE</b></li> <li>■ Axis positioning on machines with two rotary axes e.g. <b>L A+0 B+0 C+0</b> or <b>L A+Q120 B+Q121 C+Q122</b></li> </ul>	<ul style="list-style-type: none"> <li>■ All <b>PLANE</b> functions can be used</li> <li>■ Error message is issued</li> <li>■ Error message is issued</li> <li>■ Mirroring has no influence on tilting using <b>AXIAL PLANE</b> and Cycle <b>19</b></li> <li>■ Only possible after a tilting function (error message if without a tilting function)</li> <li>■ Parameters that are not defined are given the status <b>UNDEFINED</b>; they are not given the value 0</li> </ul>	<ul style="list-style-type: none"> <li>■ Only <b>PLANE AXIAL</b> is executed</li> <li>■ Incremental spatial angle is interpreted as an absolute value</li> <li>■ Incremental axis angle is interpreted as an absolute value</li> <li>■ Function is available with all <b>PLANE</b> functions</li> <li>■ Possible at any time if spatial angles are used (machine parameter setting)</li> <li>■ The control assigns the value 0 to parameters that are not defined</li> </ul>
<b>Special functions for cycle programming:</b>		
<ul style="list-style-type: none"> <li>■ FN 17</li> <li>■ FN 18</li> </ul>	<ul style="list-style-type: none"> <li>■ Function available</li> <li>■ Values are always output in metric form</li> <li>■ Further details are different</li> <li>■ Function available</li> <li>■ Values are always output in metric form</li> <li>■ Further details are different</li> </ul>	<ul style="list-style-type: none"> <li>■ Function available</li> <li>■ Values are output in the units of the active NC program</li> <li>■ Details are different</li> <li>■ Function available</li> <li>■ Values are output in the unit of the active NC program</li> <li>■ Details are different</li> </ul>
<p>Compensation of tool length in the position display</p>	<p>The tool length entries <b>L</b> and <b>DL</b> from the tool table are taken into account in the position display, from <b>TOOL CALL</b> block depending on the machine parameter <b>progToolCallIDL</b>(no. 124501)</p>	<p>The tool length entries <b>L</b> and <b>DL</b> from the tool table are taken into account in the position display</p>

### Comparison: Differences in MDI operation

Function	TNC 620	iTNC 530
Execution of connected sequences	Function available	Function available
Saving modally effective functions	Function available	Function available
Miscellaneous functions	<ul style="list-style-type: none"> <li>■ Global program settings</li> <li>■ Status display for Q parameters</li> <li>■ Block functions, e. g. <b>COPY BLOCK</b></li> <li>■ ACC setting</li> <li>■ Miscellaneous program functions, e.g. <b>FUNCTION DWELL</b></li> </ul>	<ul style="list-style-type: none"> <li>■ Global program settings</li> </ul>

### Comparison: Differences in programming station

Function	TNC 620	iTNC 530
Demo version	Programs with more than 100 NC blocks cannot be selected, an error message is issued	Programs can be selected, max. 100 NC blocks are displayed, further blocks are truncated in the display
Demo version	If nesting with <b>PGM CALL</b> results in more than 100 NC blocks, there is no test graphic display; an error message is not issued	Nested programs can be simulated
Copying NC programs	Copying to and from the directory <b>TNC:\</b> is possible with Windows Explorer	TNCremo or file manager of programming station must be used for copying
Shifting the horizontal soft-key row	Clicking on the soft-key bar shifts one soft-key row to the right or left	Clicking any soft-key bar activates the respective soft-key row

## Index

### 3

- 3-D basic rotation..... 673
- 3D compensation..... 579
  - Delta values..... 582
  - Face Milling..... 584
  - Peripheral Milling..... 586
  - Tool orientation..... 583
- 3-D compensation
  - Normalized vector..... 581
  - Tool shapes..... 582
- 3-D touch probe
  - Calibrating..... 663
  - Using..... 654
- 3-D view..... 702

### A

- About this manual..... 6
- ACC..... 498
- Accessing tables..... 425
- Accessories..... 121
- Actual position capture..... 161
- Adding comments..... **201**, 204
- Additional axes..... 151
- Additional axes for rotary axes. 565
- Adjusting spindle speed..... 638
- ADP..... 595
- Align tool axis..... 562
- Angle functions..... 374
- ASCII files..... 514
- Automatic program start..... 734
- Automatic tool measurement... 239
- Axis position, checking..... 621

### B

- Backup..... 112
- Basic rotation..... 670
  - Measuring in Manual Operation mode..... 670
- Batch Process Manager..... 612
  - application..... 612
  - creating a job list..... 615
  - editing a job list..... 617
  - executing the job list..... 618
  - fundamentals..... 612
  - job list..... 613
  - opening..... 615
- Behavior after receipt of ETX... 754
- Block..... 163
  - Delete..... 163
- Block check character..... 753
- Block scan
  - In a pallet table..... 732
  - In a point table..... 731
  - tool oriented..... 609

### C

- CAD import (option 42)..... 325
- CAD viewer
  - Defining the plane..... 332
- Calculating with parentheses... 439
- Calculation of circles..... 375
- Calculator..... 207
- Calling tool management..... 261
- CAM programming..... 579, 589
- Cartesian coordinates
  - Circular path around circle center CC..... 293
  - Straight line..... 289
- Chamfer..... 290
- Chatter Control..... 498
- Checking the axis positions..... 642
- Circle..... 294, 296, 302
- Circle center..... 292
- Circular path..... 302
  - around circle center CC..... 293
- Code number..... 750
- Comparison..... 806
- Compensating workpiece misalignment
  - By measuring two points on a straight surface..... 669
- Condition of RTS line..... 753
- Configuration data..... 776
- Connector pin layout for data interfaces..... 790
- Context-sensitive help..... 221
- Contour
  - Approach..... 278
  - Departure..... 278
- Control panel..... 90
- Coordinate transformation..... 509
- Copying program sections 165, 165
- Counter..... 512
- Counter settings..... 741

### D

- Data backup..... 112, **170**
- Data interface..... 751
  - Connector pin layouts..... 790
  - Set up..... 751
- Data output on the screen..... 390
- Data transfer
  - File system..... 753
  - Software..... 755
- Data transmission
  - Behavior after receipt of ETX..... 754
  - Block check character..... 753
  - Condition of RTS line..... 753
  - Data bits..... 752
  - Handshake..... 753
  - Parity..... 752
  - Protocol..... 752

- Software TNC server..... 754
- Stop bits..... 752
- Datum shift..... 509
  - Coordinate input..... 509
  - Resetting..... 511
  - Via the datum table..... 510
- Datum table
  - Transferring probed values... 661
- Defining local Q parameters..... 369
- Defining nonvolatile Q parameters.. 369
- Defining the workpiece blank... 158
- Dialog..... 159
- Directory..... **171**, 176
  - Copy..... 179
  - Create..... 176
  - Delete..... 180
- Displaying HTML files..... 187
- Displaying Internet files..... 187
- Display of the NC program..... 204
- Display screen..... 89
- DNC..... 764
  - Information from NC program..... 424
- Downloading help files..... 226
- Dwell time..... **526**, 527, **528**
- DXF converter
  - Setting a preset..... 330
  - Selecting hole positions
    - Icon..... 341
    - Mouse area..... 340

### E

- EnDat encoder..... 621
- Error message..... 216
  - Help with..... 216
- Ethernet interface..... 757
  - Configuration..... 757
  - Connecting and disconnecting a network drive..... 196
  - Connection possibility..... 757
  - Introduction..... 757
- External access..... 742
- External data transfer..... 194

### F

- FCL..... 750
- FCL function..... 12
- Feature Content Level..... 12
- Feed rate..... 637
  - Adjust..... 638
  - Input options..... 160
  - On rotary axes, M116..... 565
- Feed rate factor for plunging movements M103..... 476
- Feed rate in millimeters per spindle revolution M136..... 477
- File

- create..... 176
  - Sorting..... 182
  - tag..... 181
  - File functions..... 508
  - File management..... **168**, 171
    - external data transfer..... 194
    - External file types..... 170
  - File Manager
    - Calling..... 173
  - File manager
    - Copying files..... 176
    - Copying tables..... 178
    - Delete file..... 179
    - Directory..... 171
    - File type..... 168
    - Function overview..... 172
    - Overwriting files..... 177
    - Protect file..... 183
    - Rename file..... 182
    - Selecting files..... 174
  - Directories
    - Copy..... 179
    - Create..... 176
  - File status..... 173
  - Filter for hole positions with DXF
    - data update..... 342
  - Firewall..... 763
  - FK programming..... 307
    - Circular paths..... 312
    - End point..... 313
    - Fundamentals..... 307
    - Initiating dialog..... 310
    - Straight lines..... 311
  - FK-Programming
    - Graphics..... 309
  - FK programming
    - Input options
      - Auxiliary points..... 316
      - Circle data..... 314
      - Closed contours..... 315
      - Direction and length of contour elements..... 313
    - Input options
      - Relative data..... 317
  - Fluctuating spindle speed..... 524
  - FN14: ERROR
    - Displaying error messages.... 381, 381
  - FN16: F-PRINT
    - Formatted output of texts... 385
  - FN 18: SYSREAD
    - Reading system data..... 392
  - FN19: PLC
    - Transfer values to the PLC.. 421
  - FN20: WAIT FOR
    - NC and PLC synchronization.... 422
  - FN23: CIRCLE DATA
    - Calculate a circle from 3 points..... 375
  - FN24: CIRCLE DATA
    - Calculate a circle from 4 points..... 375
  - FN26: TABOPEN
    - Open a freely definable table..... 521
  - FN27: TABWRITE
    - Write to a freely definable table..... 522
  - FN28: TABREAD
    - Read from a freely definable table..... 523, 523
  - FN29: PLC
    - Transfer values to the PLC.. 423
  - FN37
    - EXPORT..... 424
  - FN38: SEND
    - Send information..... 424
  - Form view..... 520
  - Freely definable table
    - open..... 521
    - write to..... 522
  - FS, Functional safety..... 639
  - Full circle..... 293
  - Functional safety FS..... 639
  - FUNCTION COUNT..... 512
  - Fundamentals..... 140
- G**
- Gestures..... 127
  - Graphics..... 700
    - Display modes..... 702
    - With programming..... 212
    - With programming
      - Magnification of details..... 215
  - Graphic settings..... 740
  - Graphic simulation..... 708
  - Tool display..... 708
- H**
- Handwheel..... 627
  - Hard disk..... 168
  - Helical interpolation..... 303
  - Helix..... 303
  - Help system..... 221
  - Help with error message..... 216
- I**
- Inclined-tool machining in a tilted plane..... 563
  - Indexed tool..... 235
  - Inserting and modifying blocks. 163
  - Interrupt machining..... 719
  - iTNC 530..... 88
- K**
- Klartext..... 159
- L**
- Lift-off..... **529**
  - Load machine configuration.... 773
  - Look ahead..... 479
- M**
- M91, M92..... 471
  - Machine parameters..... 776
    - changing..... 776
    - changing the display..... 776
  - Machine settings..... 742
  - Manual datum setting..... 676
  - Manual presetting
    - Circle center as preset..... 680
    - Corner as datum..... 678
    - On any axis..... 677
    - Setting a center line as preset..... 683
    - Without a 3-D touch probe.. 652
  - MDI..... 694
  - Measurement of machining
    - time..... 709
  - Measuring workpieces..... 684
  - Mid-program startup..... 727
    - After power failure..... 727
  - Miscellaneous functions..... 468
    - enter..... 468
    - For path behavior..... 474
    - For program run inspection. 470
    - For spindle and coolant..... 470
  - Miscellaneous functions for
    - coordinate entries..... 471
  - Modes of Operation..... 91
  - MOD function..... 738
    - Exit..... 738
    - Overview..... 739
    - Select..... 738
  - motion control..... 595
  - Move machine axes
    - Jog positioning..... 626
  - Moving the machine axes..... 625
    - With axis direction keys..... 625
    - with the handwheel..... 627
  - Multiple axis machining.... **534**, 573
- N**
- NC and PLC synchronization.... 422
  - NC error message..... 216
  - NC program
    - Editing..... 162
  - Nesting..... 356
  - Network connection..... 196
  - Network settings..... 757

## O

Open contour corners M98.....	475
Opening a BMP file.....	191
Opening a GIF file.....	191
Opening a JPG file.....	191
Opening a PNG file.....	191
Opening a video file.....	191
Opening Excel files.....	186
Opening graphic files.....	191
Opening TXT files.....	190
Open INI file.....	190
Open TXT file.....	190
Operating times.....	749

## P

Pallet table.....	598
Application.....	598
columns.....	599
editing.....	600
inserting a column.....	602
Processing.....	603
Selecting and exiting.....	602
tool oriented.....	606
Parallel axes.....	500
Paraxcomp.....	500
Paraxmode.....	500
Part families.....	370
Path.....	171
Path contours.....	288
Cartesian coordinates.....	288
Polar coordinates.....	300
Cartesian coordinates	
Circle with tangential	
connection.....	296
Circular path with defined	
radius.....	294
Overview.....	288
Polar coordinates	
Circular path around pole	
CC.....	302
Circular path with tangential	
connection.....	302
Overview.....	300
Straight line.....	301
Path functions	
Fundamentals.....	272
Fundamentals	
Circles and circular arcs.....	275
Pre-positioning.....	276
PDF Viewer.....	185
PLANE function.....	<b>535</b> , 537
Automatic positioning.....	555
Axis angle definition.....	552
Euler angle definition.....	544
Inclined-tool machining.....	563
Incremental definition.....	551
Overview.....	537
Point definition.....	549

Positioning behavior.....	554
Projection angle definition....	542
Resetting.....	539
Selection of possible	
solutions.....	558
Spatial angle definition.....	540
Vector definition.....	546
Plan view.....	706
PLC and NC synchronization....	422
Pocket table.....	246
Polar coordinates.....	151
Fundamentals.....	151
Programming.....	300
Positioning.....	694
With Manual Data Input.....	694
With tilted working plane....	<b>473</b> , 572
Post processor.....	590
Presets	
managing.....	644
Preset table.....	<b>644</b> , <b>644</b>
transferring probed values....	662
Principal axes.....	151
Printing messages.....	391
Probing	
With end mill.....	652
Probing a plane.....	673
Probing cycles.....	655
Manual operating mode.....	655
Probing values	
writing to the preset table....	662
Probing with a 3-D touch probe	654
Process chain.....	589
Processing DXF data	
Basic settings.....	327
Filter for hole positions.....	342
Selecting a contour.....	335
Selecting machining positions....	338
Setting layers.....	329
Selecting hole positions	
Single selection.....	339
Program.....	154
Opening a new program.....	158
Structure.....	154
Structuring.....	205
Program call	
Any desired NC program as	
subprogram.....	351
Program defaults.....	491
Programming graphics.....	309
Programming tool movement...	159
Program run.....	717
Execute.....	718
Interrupt.....	719
Mid-program startup.....	727
Overview.....	717
Resuming after interruption.	723

Retraction.....	724
Skipping blocks.....	735
Program-section repeat.....	349
Program Test	
Overview.....	713
Projection in three planes.....	706
Protection zone.....	744
Pulsing spindle speed.....	524

## Q

Q parameter	
Export.....	424
programming.....	<b>366</b>
Transfer values to the PLC..	423
Q-Parameter	
Transfer values to the PLC..	421
Q parameter programming	
Additional functions.....	380
Angle functions.....	374
Calculation of circles.....	375
If-then decisions.....	376
Mathematical functions.....	371
Programming notes.....	368
Q parameters.....	366
Checking.....	378
Formatted output of.....	385
Local parameters QL.....	366
Preassigned.....	456
Programming.....	443
Residual parameters QR....	366
String parameters QS.....	443

## R

Radius compensation.....	257
Entering.....	258
Outside corners, inside	
corners.....	259
Rapid traverse.....	230
Reading out machine parameters....	453
Reading system data.....	<b>392</b> , 448
Reference system.....	141, 151
Basic.....	144
Input.....	148
Machine.....	142
Tool.....	149
Working plane.....	147
Workpiece.....	145
Replacing texts.....	167
Resonance vibration.....	524
Restore.....	112
Retraction.....	724
After a power interruption....	724
Retraction from the contour....	483
Returning to the contour.....	733
Rotary axes.....	565
Rotary axis	

- Reduce display M94..... 567
  - Shortest-path traverse
    - M126..... 566
  - Rounded corners..... 291
  - Rounding corners M197..... 488
- S**
- Save service files..... 220
  - Screen
    - cleaning..... 138
  - Screen keypad..... 200
  - Screen layout..... 90
  - Screen layout of CAD viewer... 324
  - Search function..... 166
  - Selecting a contour from DXF.. 335
  - Selecting positions from DXF... 338
  - Selecting the preset..... 153
  - Selecting the unit of measure.. 158
  - Select kinematics..... 745
  - Set BAUD rate..... 751
  - Set data transmission speed... 751
  - Software number..... 750
  - SPEC FCT..... 490
  - Special functions..... 490
  - Spindle speed
    - Entering..... 249
  - SQL commands..... 425
  - Status display..... 94
    - Additional..... 96
    - General..... 94
  - Stop at..... 716
  - Straight line..... **289**, 301
  - String parameter
    - Converting..... 449
    - Copying a substring..... 447
    - Finding the length..... 451
    - Testing..... 450
  - String parameters..... 443
    - Assign..... 444
    - Chain-linking..... 445
    - Reading system data..... 448
  - Structuring programs..... 205
  - Subprogram..... 347
    - Any desired NC program.... 351
  - Superimposing handwheel
    - positioning M118..... 481
  - Surface normal vector...
    - 546, 564, 579, **581**
  - Switch-off..... 624
  - Switch-on..... 620
- T**
- Table access..... 522
  - Taskbar..... 101, 136
  - TCPM..... 573
  - Reset..... 578
  - Teach In..... **161**, 289
  - Test Run..... 712
  - Test run
    - Executing up to a certain
      - block..... 716
    - Execution..... 715
  - test run
    - Setting speed..... 701
  - Text editor..... 203
  - Text file..... 514
    - Delete functions..... 515
    - Finding text sections..... 517
    - Formatted output..... 385
    - Opening and exiting..... 514
  - Text variables..... 443
  - Tilt
    - Working plane..... **535**
  - Tilted axes..... 568
  - Tilting
    - Resetting..... 539
    - Working plane..... 537
  - Tilting the working plane..... 687
    - Manual..... 687
  - Tilting without rotary axes..... 562
  - Tilt working plane
    - programmed..... 535
  - TNCguide..... 221
  - TNCremo..... 755
  - TOOL CALL..... 249
  - Tool carrier management..... 493
  - Tool change..... 251
  - Tool compensation..... 256
    - Length..... 256
  - Tool Compensation
    - Radius..... 257
  - Tool compensation
    - Three-dimensional..... 579
  - Tool data..... 232
    - Calling..... 249
    - Delta values..... 233
    - Entering into the program... 233
    - Enter into the table..... 234
    - Export..... 268
    - Import..... 268
    - Indexing..... 241
  - Tool length..... 232
  - Tool management..... 260
    - Editing..... **262**
    - Tool types..... 266
  - Tool measurement..... 239
  - Tool name..... 232
  - Tool number..... 232
  - Tool-oriented machining..... 606
  - Tool oversize
    - Suppress error message
  - M107..... 580
  - Tool radius..... 232
  - Tool table..... 234
    - Edit, exit..... 240
    - Editing functions..... 240
    - Filter functions..... 242
    - Input options..... 234
  - Tool usage file..... 254, **745**
  - Tool usage test..... 254
  - Touch gestures..... 127
  - Touch operating panel..... 125
  - Touch probe cycles
    - Manual..... 655
  - Touch probe monitoring..... 485
  - Touch probe with radio
    - transmission
      - Configuration..... 768
  - Touchscreen..... 124
    - calibration..... 137, 137
    - cleaning..... 138
    - configure..... 137
  - TRANS DATUM..... 509
  - Traverse limits..... 744
  - Traversing reference marks..... 620
  - Trigonometry..... 374
  - T vector..... 581
- U**
- USB device
    - Connecting..... 197
    - Removing..... 198
  - User parameters..... 776
  - Using touch probe functions with
    - mechanical probes or measuring
      - dials..... 653
- V**
- Vector..... 546
  - Version number..... **750**
  - Version numbers..... 773
  - Virtual tool axis..... 482
- W**
- Window Manager..... 100
  - Wireless handwheel..... 630
    - Assign handwheel holder.... 770
    - Configure..... 770
    - Selecting transmitter power. 771
    - Setting channel..... 771
    - Statistical data..... 772
  - Wireless touch probe
    - Setup..... 766
  - Working space monitoring..... **710**
  - Workpiece positions..... 152
  - Workspace monitoring..... 715
  - Write to log..... 424
  - Writing probing values
    - Log..... 660

To the datum table.....	661
<b>Z</b>	
ZIP archive.....	189

# HEIDENHAIN

## DR. JOHANNES HEIDENHAIN GmbH

Dr.-Johannes-Heidenhain-Straße 5  
83301 Traunreut, Germany

☎ +49 8669 31-0

FAX +49 8669 32-5061

E-mail: info@heidenhain.de

**Technical support** FAX +49 8669 32-1000

**Measuring systems** ☎ +49 8669 31-3104

E-mail: service.ms-support@heidenhain.de

**NC support** ☎ +49 8669 31-3101

E-mail: service.nc-support@heidenhain.de

**NC programming** ☎ +49 8669 31-3103

E-mail: service.nc-pgm@heidenhain.de

**PLC programming** ☎ +49 8669 31-3102

E-mail: service.plc@heidenhain.de

**APP programming** ☎ +49 8669 31-3106

E-mail: service.app@heidenhain.de

www.heidenhain.de

www.klartext-portal.com

The Information Site for  
HEIDENHAIN Controls

### Klartext App

The Klartext on Your  
Mobile Device

Google  
Play Store

Apple  
App Store



## Touch probes from HEIDENHAIN

help you reduce non-productive time and improve the dimensional accuracy of the finished workpieces.

### Workpiece touch probes

**TS 220** Signal transmission by cable

**TS 440, TS 444** Infrared transmission

**TS 640, TS 740** Infrared transmission

- Workpiece alignment
- Setting presets
- Workpiece measurement

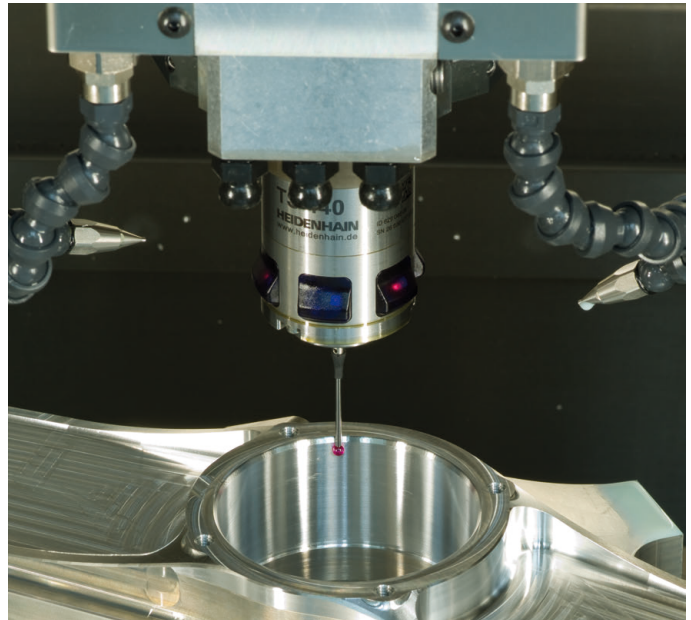

### Tool touch probes

**TT 140** Signal transmission by cable

**TT 449** Infrared transmission

**TL** Non-contacting laser systems

- Tool measurement
- wear monitoring
- tool breakage detection

